

C

CATALOGUE No. 118

HOLBROOK, MERRILL & STETSON

San Francisco, Los Angeles

California, U. S. A.



Class TH6255

Book H7

Copyright N^o 1905

COPYRIGHT DEPOSIT.

COMPLIMENTS OF

HOLBROOK, MERRILL & STETSON

No. **295**

To

.....

.....

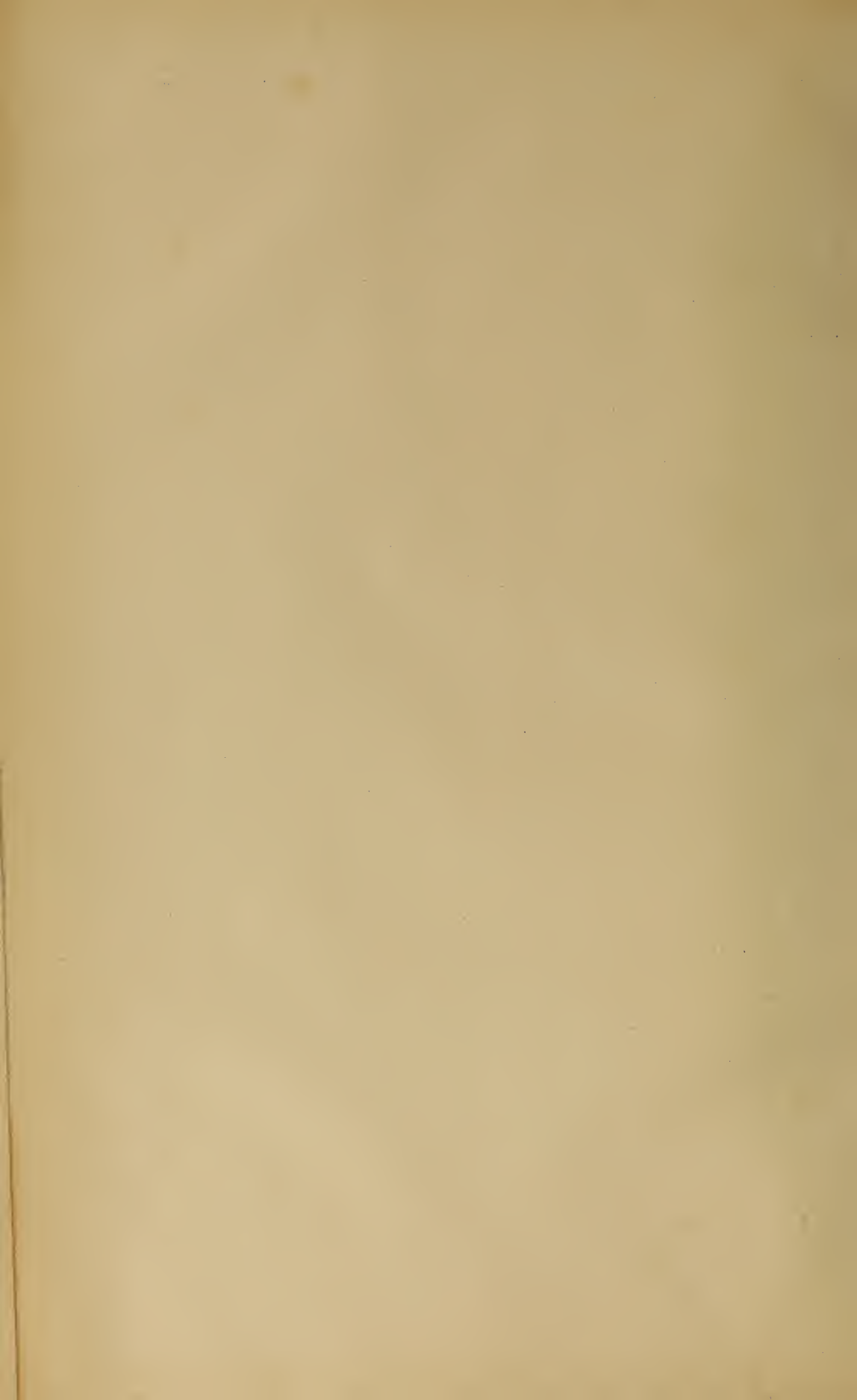

ESTABLISHED 1850

INCORPORATED AUGUST 28, 1882

Holbrook, Merrill & Stetson

CATALOGUE C

No. 118

Sanitary Plumbing Fixtures and Supplies

General Offices and Showrooms:

221 to 239 Market St. and 1 to 17 Beale St.
San Francisco

218 to 224 North Los Angeles St.
Los Angeles

Eastern Office
256 and 257 Broadway, New York



~~TH 173~~
~~H7A~~

TH 255
H7
1915

LIBRARY of CONGRESS
Two Copies received
AUG 2 1905
Copyright Entry
June 22, 1905
CLASS a Xxc. No
119791
COPY B.

ENTERED ACCORDING TO ACT OF CONGRESS, IN THE YEAR 1905,
BY
HOLBROOK, MERRILL & STETSON
IN THE OFFICE OF THE LIBRARIAN OF CONGRESS, AT WASHINGTON, D. C.

CA-9-520A
Linn

PRINTING AND BINDING
THE HICKS-JUDD COMPANY
SAN FRANCISCO

PHOTO ENGRAVING
CALIFORNIA PHOTO ENGRAVING CO.
SAN FRANCISCO

PAPER
BLAKE, MOFFITT & TOWNE
SAN FRANCISCO, LOS ANGELES,
PORTLAND AND SEATTLE

C
C
C
C
C
C



SAN FRANCISCO HOUSE.



LOS ANGELES HOUSE.

INTRODUCTION

We present this catalogue believing that the trade will appreciate our efforts in compiling a book illustrating all that is best in sanitary appliances and plumbing supplies.

The illustrations of plumbing fixtures are all made from direct photographic reproductions of the articles set up complete as for service in the manner and position in which they are shown. Thus we show in miniature the article itself.

Manufacturers' lists have been used as far as possible. We also give dimensions, capacities, weights, etc., and where practicable have inserted approximate shipping weights and measurements. A code word is provided for every article in this catalogue, and when used in connection with the general code provided, will serve to reduce the cost of cable and telegraphic orders.

We bespeak your careful attention to the following pages and request your consideration in our behalf.

Respectfully yours,

HOLBROOK, MERRILL & STETSON.

Terms, Conditions and Instructions

When ordering, give plate number and size; also details according to catalogue description, and thus save time and correspondence and avoid confusion.

Specifications for goods not standard should be explicit and complete, and, when possible, accompanied by sketch

Contracts are subject to delays incident to strikes, accidents, or causes beyond our control.

Definite instructions as to route, packing, insurance, etc., should accompany each order; otherwise we will not insure and route is optional with us.

As there is a constant improvement in styles of plumbing fixtures, it is impossible to give dimensions and sizes that will continue as at present; but this information for any fixture shown herein will be furnished upon request.

Boxing and cartage charged at cost.

Claims for shortage must be made immediately upon receipt of shipment.

No goods taken back or exchanged unless by mutual agreement.

Our responsibility for loss or damage ends after obtaining transportation company's receipt in good order.

All quotations, unless otherwise stated, are made at our stores in San Francisco or Los Angeles and are subject to change without notice.

Lists and discounts subject to change at any time without notice.

Our terms for parties with approved credit are sixty days net cash, or two per cent for cash in ten days.

To all parties who have no arrangements for credit, we should receive references or cash with orders.

All overdue accounts are subject to sight draft without notice.

Correspondence to receive our immediate attention should be addressed to the firm and not to individuals.

TELEGRAPH CODE.

For convenience of customers, the following sentences may be used for inquiries concerning orders, shipments, quotations, etc., in conjunction with the Code Words throughout the Catalogue.

Cable Address: "Holmerson."

ORDERS.

Cladole.....	Add to order
Clepturos.....	Cancel our order
Clericatos.....	Cannot furnish as ordered
Climatal.....	Change to read
Cloddish.....	Duplicate order for
Cloghead.....	Duplicate our last order for
Cloporte.....	Duplicate invoice
Cobertor.....	Get ready. We send order by mail
Cockspur.....	Have cancelled
Codapail.....	Hold order until you receive our letter
Cognitive.....	If not too late, change order to read
Cognobile.....	In addition to our order
Cohibit.....	Include with order
Colafizza.....	Must fill order with
Colateur.....	None of the goods ordered are in stock
Colecta.....	Order to cancel came too late
Collatrabo.....	Please rush order
Columbro.....	What is the earliest date you can fill order
Comparant.....	Use your own judgment about filling order
Comparto.....	Your countermand received. Order cancelled
Condurdis.....	Can furnish only

SHIPPING.

Cosmica.....	Are shipping today
Cosmocere.....	Await shipping instructions
Cospirava.....	By what route have you shipped
Cossument.....	Cannot ship in less than
Costanzo.....	Can ship at once on receipt of order
Costilatos.....	Can ship immediately
Costolone.....	Can you ship
Cotovelo.....	Do not ship before hearing from us
Cottonade.....	Do not delay order
Couchez.....	Follow instructions as sent you
Crimofilo.....	Must have prompt shipment
Crisitrice.....	Promise shipment this week
Crispais.....	Send by mail immediately
Criticun.....	Ship at once
Crocifere.....	Ship by express immediately
Crogdal.....	Ship via cheapest route
Crogmar.....	Ship via quickest route
Croiter.....	Ship by first steamer
Crosistas.....	Ship by railroad immediately
Crudarios.....	Ship by sail
Crumbly.....	Ship half on first steamer, balance on next
Crustosi.....	Ship in addition to previous order
Cubetas.....	Ship part at once, remainder to follow
Cubia.....	Ship via Santa Fe R. R.

Cubicados.....	Ship via Southern Pacific R. R.
Cubicafago.....	Ship via Southern Pacific and Northern Pacific R. R.
Cubicagom.....	Ship via Southern Pacific and O. R. & N.
Cubigall.....	Ship via Great Northern R. R.
Cubillest.....	Ship via Northern Pacific R. R.
Cubiment.....	Ship via Pacific Coast S. S. Co.
Cubinabo.....	Ship via Pacific Coast S. S. Co. and Great Northern R. R.
Cubineed.....	Ship via Pacific Coast S. S. Co. and Northern Pacific R. R.
Cubique.....	San Francisco & Portland S. S. Co.
Cubitabunt.....	San Francisco & Portland S. S. Co. & Northern Pacific R. R.
Cubitales.....	San Francisco & Portland S. S. Co. & Great Northern R. R.
Cubitatum.....	San Francisco & Portland S. S. Co. & Oregon R. & N. Co.
Cubitavero.....	San Francisco & Portland S. S. Co. & Southern Pacific R. R.
Cubirrod.....	Ship via Pacific Mail S. S. Co.
Cubiscay.....	Ship via Occidental & Oriental S. S. Co.
Cubitane.....	Ship via Tōyo Kisen Kaisha S. S. Co.
Cubitick.....	Ship via Oceanic S. S. Co.
Cuboard.....	Ship via Kosmos S. S. Line
Cuboden.....	Ship via American-Hawaiian S. S. Co.
Cubofame.....	Ship via Hawaiian Line of sailing vessels
Cubokid.....	Ship via Planters Line of sailing vessels
Cubollar.....	Ship via Spreckels Line of sailing vessels
Cubombat.....	Ship via China-Commercial S. S. Co.
Cubonist.....	Ship via San Pedro, Los Angeles & Salt Lake R. R.
Cultiver.....	Shipment can be made within
Cumbulis.....	Shipment has been forwarded
Cupivista.....	Shipping instructions by letter
Cursitatum.....	When can you ship for certain
Curtana.....	Will be shipped at once as ordered
Curtsy.....	Will ship

QUOTATIONS.

Defamibus.....	Are quotations of.....now good
Defecano.....	As per prices quoted
Defendias.....	At what price and how soon can you furnish
Deforas.....	For immediate acceptance
Deforsor.....	For immediate acceptance by telegraph
Defoul.....	For this order only we quote
Delicater.....	Order subject to quotation of.....
Delubris.....	Prices are withdrawn
Delustro.....	Prices good till
Demagoras.....	Prices quoted are net cash
Demancher.....	Prices quoted subject to discount of.....
Demerged.....	Quote lowest price and state earliest delivery
Demigola.....	Quote price by mail
Demigras.....	Quote price by wire
Demorsita.....	Send us new prices
Demoticas.....	Subject to change without notice
Denticis.....	These quotations will be good for.....
Denudated.....	This is a special price
Depecege.....	We quote in reply to your inquiry by letter of.....
Depellis.....	We quote in reply to your inquiry by telegram of.....
Depositions.....	Will send new price by mail
Depravant.....	Will wire you new price
Derivamos.....	Price or prices effective immediately.
Derivant.....	Quote price or prices F. O. B.....
Derivassi.....	Prices quoted are F. O. B.....

Following Table shows Code Words for Quantities: by Numbers, Dozen, Gross, Pounds, Tons or Feet.

		DOZEN.	GROSS.	POUNDS.	TONS OF 2000 LBS.	FEET.
¼	Abagarus	Acibar	Acineta	Acladas	Acolabure	Amabas
½	Abalizo	Acibarado	Acineux	Aclade	Acolacent	Amabit
¾	Abandero	Acibaraís	Acinippo	Acladios	Acoladry	Amacare
1	Abanican	Acibaroso	Acinopes	Aclamador	Acolaga	Amache
1½	Abap	Aciberaba	Acinosos	Aclamar	Acolagist	Amacollar
2	Abarcamo	Aciberar	Acinosum	Aclamaron	Acolaird	Amacores
2½	Abaritam	Acibero	Acintado	Aclamases	Acolakme	Amadatha
3	Abarroto	Acicalan	Acintli	Aclamaste	Acolally	Amadinas
3½	Abasis	Acicales	Acinule	Aclamo	Acolament	Amadotta
4	Abast	Acicalo	Acinulos	Aclarado	Acolamich	Amadrina
4½	Abatard	Acicate	Acioas	Aclasto	Acolamore	Amagostar
5	Abatimos	Aciculated	Aciotis	Aclavillas	Acolante	Amagues
5½	Abators	Acidulias	Acipadas	Aclimatan	Acolanzo	Amalaban
6	Abavorum	Acidalie	Acipha	Aclinico	Acolappis	Amalago
6½	Abayant	Acidaro	Aciphore	Acliode	Acoledir	Amalias
7	Abbacare	Acidates	Acirates	Aclisia	Acoleere	Amalocia
7½	Abbacken	Acidetta	Acisba	Aclocado	Acolegite	Amanares
8	Abbade	Acidifere	Acisculi	Aclocar	Acolemmo	Amancebo
8½	Abbatic	Acidifiant	Acisele	Aclope	Acolerige	Amancio
9	Abbin	Acidifico	Acistico	Acloquen	Acoliable	Amandavi
9½	Abombo	Acidifique	Acitho	Aclouet	Acoliang	Amanderis
10	Abbonito	Acidinus	Acitron	Aclydem	Acolibber	Amandier
11	Abbracio	Acidiser	Acker	Aclydis	Acolictor	Amanicum
12	Abbroch	Acidonte	Ackerbeet	Aclyd	Acolidur	Amansum
13	Abdalas	Acidorum	Ackergaul	Acmanite	Acoligny	Amantesco
14	Abdenago	Acidotone	Ackergras	Acmastico	Acolimbos	Amanza
15	Abdico	Acidulado	Ackerhof	Acmelias	Acolissom	Amarasca
16	Abducido	Acidulous	Ackerklee	Acmelle	Acolithic	Amarendo
17	Abduzo	Acidulum	Ackerland	Acmena	Acollecto	Amargoso
18	Abeel	Acidume	Ackermass	Acmenes	Acollind	Amarissi
19	Abeggen	Acidurgia	Ackerochs	Acmenidi	Acolorine	Anartelo
20	Abelasir	Acierant	Ackerrabe	Acmocere	Acolunare	Amasonie
25	Abendzug	Aciereux		Acnatero		Amazonas
30	Abexing	Aciertas		Acnephale		Ambicus
35	Abianus	Acies		Acnestis		Ambotrace
40	Abimant	Acifillas		Acniste		Ambulatos
45	Ablacto	Aciform		Acnuam		Amenos
50	Abluant	Acigne		Acoalto		Amerinos
55	Abner			Acbarido		Amictico
60	Abolani			Acocat		Amiral
65	Aboon			Acocheis		Ammah
70	Abraider			Acochino		Amoando
75	Abringen			Acodalas		Amoletis
80	Abrumas			Acodalo		Amorgi
85	Absoer			Acodilles		Ampanon
90	Absuper			Acodillo		Amputato
95	Aburrido			Acoello		Amusante
100	Acabados			Acoetes		Anacope
150	Acabando			Acogedizo		Anacrisis
200	Acabramo			Acogedor		Anademo
250	Acacetos			Acogeis		Anadido
300	Acadien			Acogidas		Anadose
400	Acaristo			Acognosie		Anafeste
500	Acarpia			Acogollar		Anafres
600	Acartum			Acogollo		Anagenita
700	Acastide			Acogombro		Anaglifo
800	Acatado			Acogotais		Anaklet
900	Acataron			Acogotar		Analect
1000	Acatonis			Acografia		Analgia
2000	Accampato			Acolhos		Anapius
3000	Accantitas			Acolabais		Anarazel

GENERAL INDEX.

A
B
C
D
E
F
G
H
I
J
K
L
M
N
O
P
Q
R
S
T
U
V
W
X
Y
Z

A

Acid—Muratic	692
Acme Back Water Sewer Valves.....	648a
Air Chambers—Sink.....	395
“ Cocks	520
“ Valves	520
Ajax Hopper Closet	47
Alameda Washout Closet	46
Alfa Washdown Siphon Closet.....	32
Alma Washdown Siphon Closet	34
Alligator Wrenches	799
Aluminum Gas Tips	497
“ Paint	695
American Long Screws	599
Angle Plate Vises	793
Angle Valves—Flushometer	8
“ Supply Valves	104
“ Valves—Brass	536 to 539
Anti-Freezing Closets.....	57, 58
Antimony	689
Apothecary's Measure	821
“ Weight	821
Apron Wall Supports.....	368
Aprons—Marble	290
Armstrong's Pipe Vise	795
“ Stocks and Dies.....	771
Asbestos Mill Board.....	693
“ Packing	693
“ Paper	693
Atlantic Ship Water Closet.....	74
Atlas Pipe Wrench.....	798
Augers—Gas Fitters.....	720
Auto Hopper Closet.....	54
Automatic Tanks	146
“ Tank Connections	146
Avoirdupois Weight	821
Awls—Scratch	719, 720

B

Babbitt Metal	691, 692
Back Water Valves.....	648a
Backs—Marble	290
Sink, Cast Iron, Enameled....	396, 397
“ Steel	404
Badge Air Valves.....	520
Bag Traps	355
Bags—Tool	721
Bailey Slop Hoppers.....	423
Ball and Socket Joints.....	230
Ball Cocks—Closet Tank.....	111
Compound Lever	111
Compression	521

Ball Cocks—Dale	111
Foster	111, 522
Ground Key	521
Ball Joint Shower Heads.....	230
Balls—Copper	109, 492
Float	109, 492, 493
Glass	109, 493
Naugatuck	492
Zinc	109, 493
Balls for Fuller Bibbs.....	502
Bands—Pipe	641
Barber Lavatories—Marble	284, 285
Enameled	327
Barber Slabs	284, 285
Barnes' Pipe Cutters	733
Bars—Closet Tank	110
Roller Towel	248
Towell, N. P.....	247 to 251
“ Opal Glass	251
“ Plate “	252, 253
“ Swing	250a, 251
Basin Chains	489
“ Clamps	491
“ Cocks	342 to 351
“ Cock Washers	362
“ Gaskets	362
“ Grates	482
“ Plugs	479 to 481
“ Slabs	286 to 290
“ “ —Marble Corner.....	286, 288
“ “ “ Recess	287
“ “ “ Quarter Circle..	286
“ Wrenches	802
Basins—“D” Pattern, Earthenware....	294
Enameled	295
Round, Earthenware	291, 292
Oval “	293
Baskets—Towel	246a, 247
Urinal	145
Bath Bibbs	507
“ Chains	489
“ Cock Couplings	202
Bath Cocks	200, 201
“ with Supply Pipes.....	202, 203
Bathing Caps	233
Bath Mats—Cork	265
Rubber	265
Bath Plugs	479 to 481
“ Room Fittings.....	234 to 266
“ Sprays	231, 232
“ Supply Pipes	204
“ Sprays—Massage	232a
Baths Enameled	164 to 193
Foot, Enameled	193
“ Solid Porcelain	163

Baths—Enameled—Hospital	189	Boilers—Steam Cottage	446
Needle Shower.....	214 to 217	" Mercer	448 to 451
Shower	214 to 226	Water, Cottage	445
Sitz, Enameled	190 to 192	" Mercer	448 to 451
" Solid Porcelain	162	Bolt Heads	151
Solid Porcelain.....	157 to 163	Bolts—Closet	107
Steel, Copper Lined.....	196	Closet Seat	112
" Enameled	197, 198	Door	153
" Nickeloid	196	Floor Flange	107
Zinc	199	Expansion	152
Bath Tub Decorations	194, 195	Stall	151
" " Enamel	695	Stove	655
" " Gaskets	362	Bolts for Cast Iron Sinks	398
" " Hand Rails	247	" " Columbus Sinks	401
" " Head Rests	264	" " New Era Sinks	403
" " Mats	265	Borers—Tap	721, 722
" " Seats	264, 264a	Bossing Sticks	738
" " Soap Dishes	237, 243, 244	Boston Siphon Jet Closet	30
" " Straps	264	Bowls—Closet Enameled	88
" " Traps	206	" Siphon Jet	80
" " Wastes	205, 207	" Wash Down	81 to 83
Bell Supply and Waste	207	" " Out	84
" Traps	484	Lavatory	291 to 295
Bench Plates	716	Box Plates	498
" Shears	762	Boxes—Grease, Rosin and Flour	722
Benders—Lead Pipe	722, 723	Sidewalk	428
Bending Pins	752	Street Washer	428
Bends—Cast Soil Pipe	629 to 632	Toilet Paper	256
Lead	468	Valve	555
Bends and Ferrules	469	Ventilating	427
Bent Ferrules—Brass	476	Braces—Drill	736
Berkeley Roofing Tin	687	Bracket Bodies	494
Bibb Flanges	490	Brackets—Apron	368
" Washers	508	Closet Seat	370
Bibbs—Bath	507	" Tank	370
Compression Hose	504, 506	Concealed Lavatory	363
" Monarch	506	Foot Rail	604
" Plain	503, 505, 506	Gas	495, 496
Fuller Hose	500, 501	Lavatory	368 to 370
" Monarch	501	Sink	397, 398, 403
" Plain	499, 501	Branches—Tee, Soil Pipe	632 to 635
Lever Hose	511	Y, Soil Pipe	636 to 638
" Plain	509, 510	Upright Y.....	634a
Self-Closing, Doherty	515	Branch Tees	619
" Moore's	515	Brass Collars—Threaded	477
" Telegraph	516	" Ferrules	476
Bidets	208	" Pipe	663
Signal & Keller Pipe Threading Machines	766 to 768	" " Fittings	606
Blades—Hack Saw	756a	" Sleeves	477
Blow Pipes	752	" Slip Joint Nuts	477
Boards—Closet Tank	109	" Strainers	478
Drain, Sink	394	" Tubing	662, 663
Bobs—Plumb	721	" —Sheet	664
Bodies—Bracket	494	Brazier's Torches	781 to 788
Boiler Couplings—Brass	474	Breast Drills	736
" —Malleable	593	Brighton Closet Range	64 to 67
" Rings	434	Brilliantshine	69
" Stands	435	Bronze—Tobin	667
Boilers—Range	431 to 434	Broughton Basin Cocks	349
		Brown's Pipe Tong	796

Brushes—Fountain 266
 Soil 723
 Buggy Washers 714
 Bulbs—Sure Grip 231
 Bumpers—Rubber 112
 Tack 112
 Burner Pliers 751
 Burrs—Tin 655
 Bushings—Brass 606
 “ —Cast Iron 613
 “ —Hose 711
 “ —Malleable 598
 “ or Guides for Pipe Stocks..... 775
 Buzzell Basin Wrenches 802

C

California Street Washers..... 713
 Campbell Sink Brackets 397
 Canfield Rubber Couplings 108
 Cans—Capacity of 809
 Cape Chisels 725
 Caps—Bathing 233
 Brass 606
 Cast Iron 612
 Malleable 590
 Ventilating 642
 Castings—Shrinkage of 813
 Cast Iron Screwed Fittings 607 to 621
 “ Soil Pipe 628
 Caulking Chisels 727
 “ Lead 689
 Ceiling Plates 621
 Cement—Gas Fitters 651
 “ —Imperial 696a
 “ Laundry Trays 413
 Century Tapping Machines 777
 Cesspool Plates 427
 Cesspools—Cast Iron 425
 Hydrant 426
 Stall 425
 Chabot Cocks 532
 Chain—Gunters 819
 “ Pipe Vises 790
 “ Stays 484 to 486
 Chain Tongs 796
 Chains and Snaps 489
 “ —Basin 489
 Bath 489
 Jack 487
 Safety 488
 Wash Tray 489
 Chambers—Air 395
 Champion Overflow Slop Hoppers..... 423
 “ Water Filters 714a, 714b
 Chandelier Hooks—Malleable 591
 Charcoal 692
 Check Valves 540
 Chicago Gooseneck Connections 713

Chino Wash Down Siphon Closet..... 41
 Chipping Knives 745
 Chisels—Cape 725
 Caulking 727
 Colding 724
 Diamond Nose 725
 Floor 726
 Half Round Nose 725
 Lantern 724
 Packing 728
 Round Nose 725
 Wire 724
 Wood 726
 Yarning 728
 Cigar Rests 261
 Circle—Properties of 824
 Circular Snips 759
 Cisterns—Capacity of 810
 Clamps—Basin 491
 Closet 107, 108
 Hose 709, 710
 Hydrant 592
 Service 615
 Stall 147, 148
 Tank Board 109
 Classification—Freight 827, 828
 Clayton & Lambert Fire Pots..... 780
 “ “ “ Torches 780 to 783
 Cleanouts—Soil Pipe 639
 Closet Bolts 107
 “ Bowls—Enameled, Siphon Jet... 88
 Enameled Wash Down 88
 “ “ Out 88
 Hopper, Siphon Jet..... 83
 Siphon Jet 80
 Wash Down Siphon 81 to 83
 “ Out 84, 85
 Closet Clamps 107, 108
 “ Couplings 108
 “ Floor Flange 106
 “ Gasket 106
 “ Hoppers 85 to 93
 “ Pans—Copper 108
 Closet Repairer—Superior 108
 “ Screws 107
 “ Seat Bolts 112
 “ “ Bumpers 112
 “ “ Hinges 112
 “ Seats 97 to 100
 “ Supplies—Slip Joint 102
 “ Tank Boards 109
 “ “ Pulls 109
 “ Tanks 94 to 96
 “ Washers 107
 Closets—Alameda 46
 Alfa 32
 Alma 34
 Ajax 47
 Auto 54
 Boston 30

C
 D
 E
 F
 G
 H
 I
 J
 K
 L
 M
 N
 O
 P
 Q
 R
 S
 T
 U
 V
 W
 X
 Y
 Z

Closets—Chino 41
 Eddy 40
 Elb 52
 Flushometer 3 to 25
 Gila 53
 Gnu 36
 Hilo 44
 Hopper 90, 91
 Indus⁴ 49
 Jumbo 12
 Kelly 56 to 58
 Latona 10
 Nemo 55
 New Dome 38
 “ Gem 28
 Oxus 50
 Pinal 48
 Prison 54a
 Rainier 45
 Ramona 26
 Range, Brighton 64 to 67
 “ Individual Bowl 61 to 63
 “ Parson’s Trough 59
 “ Siphon Eduction 58a, 58b
 Rosalia 9, 13, 14, 17
 Rush 39
 Ship, Atlantic 74
 “ Columbia 72
 “ Dandy 77
 “ Delaware 75
 “ H. M. & S. 79
 “ Knockabout 78
 “ Neptune 68, 69
 “ “ Jr. 70, 71
 “ Pacific 73
 “ Sands 76
 Sonoma 16
 Tiber 11
 Tigris 51
 Togo 43
 Tuma 15
 Volga 42
 Water 9 to 58
 Cloths—Wiping 728
 Cock Hole Covers 486
 Cocks—Air 520
 Ball, Compression 521
 “ Foster 111, 522
 “ Lever 521
 Basin, Compression 347, 348
 “ Fuller 342 to 345
 “ Self-Closing 349, 350
 “ Swing 346
 Bath 200, 201
 Chabot 532
 Cooler 516
 Corporation 533
 Gas 494
 “ Stop 494
 Hose, Gas 494

Cocks—Independent Gas 494
 Jeffress 532
 L Burner 494
 Lock 518
 Meter 532
 Milk 519
 Oil 519
 Pantry 351
 Racking 518
 Service, Brass 530, 531
 “ Iron 531
 Shampoo 346
 Ship Closet 79
 Sill, Compression 535
 Stop 523 to 529
 Urinal 142, 145
 Urn 519
 Cold Chisels 724
 Collars—Flush Pipe 108
 Threaded Brass 477
 Colma Closet 86
 Columbia Ship Water Closet 72
 Columbus Sinks 400, 405
 Comb and Brush Holder 246, 263
 Combination Plyers 750
 “ Shears and Pipe Crimper 760, 761
 Compass Saws 756
 Compasses 734
 Compound Lever Ball Cocks 111
 Compression Ball Cocks 521
 “ Basin Cocks 347, 348
 “ Bath Bibbs 507
 “ “ Cocks 200
 “ Hose Bibbs 504, 506
 “ Oil Cocks 519
 “ Pantry Cocks 351
 “ Plain Bibbs 503, 505, 506
 “ Sill Cocks 535
 “ Stops 523, 524
 “ Wash Tray Bibbs 513, 514
 Conductor Pipe 680
 Connected Waste and Overflow 205
 Connections—Automatic Tank 146
 Flush Pipe 105
 Goose Neck 713
 Rubber, Elbow 105
 “ Straight 105
 Sink 361
 Slip Joint, Elbow 491
 “ “ Straight 204
 Urinal 144
 “ Adjustable 145
 Continuous Waste Pipes 359
 Cooler Cocks 516
 Copper Balls 109, 492
 “ Pantry Sinks 405
 “ —Sheet 665, 666
 Coppers—Solder 729, 730
 Cork Bath Mats 265
 Cornice Copper 666

Corner Sinks 393
 Coronet Radiators 455
 Corporation Cocks 533
 Corrugated Iron 673, 674
 Cottage Steam Boilers 446
 " Water Boilers 445
 Cotton Waste 651
 Couplings—Bath Cock 202
 Boiler, Brass 474
 " Malleable 593
 Brass 606
 Cast Iron 617
 Closet 108
 Hose 709
 Malleable 586, 587
 Plain 475
 Rubber, Canfield 108
 Sink 399, 401, 403
 " Columbus 401
 " New Era 403
 Tank 110
 Covers—Cock Hole 486
 Sidewalk Box 428
 Trap 643
 Crescent Instantaneous Water Heaters..
 440 to 442
 Crimping Tongs 762
 Crosses—Brass 606
 Cast Iron 611
 Drainage 626
 Hand Rail 604
 Malleable 585
 Railing 603
 Crossovers—Malleable 592
 Cubic Measure 819
 Cup Leathers 110
 Cups—Drip for Drinking Fountains..... 484
 Force 729
 Soil 728
 Curtain Rings 233
 " Rods 233
 " Snaps 233
 Curtains—Shower Bath 233
 Cutters—Lead Pipe 731
 Pipe 732, 733
 Washer 731
 Cutting Nippers 747

D

Dale Ball Cock 111
 Dandy Pump Water Closet..... 77
 Decimal Parts of a Foot..... 820
 Deck Screws 475
 Decorations—Bath Tub 194, 195
 Delaware Ship Water Closet..... 75
 Detroit Radiator Valves 541
 Diadem Radiators 454
 Diamond Nose Chisels 725

Diamond Universal Sink Trap 360
 " Vises 790
 Dies—Pipe, Holland 774
 Nye 773
 Dipped Pipe 574
 Direct Indirect Radiators 457
 " Radiators 452 to 456
 Dishes—Soap, Bath Tub 237, 243, 244
 Soap, Nickel Plated..... 234 to 244
 " Porcelain 262
 Dividers—Wing 734
 Doherty Basin Cocks 350
 " Bibbs 515
 " Pantry Cocks 351
 Domestic Water Heaters 438
 Double Basin Cocks 345
 " Cutting Shears 761
 " Hubs 643
 " Pantry Cocks 351
 " Seamers—Roofing 716, 719
 Drainage Fittings—Cast Iron Screwed..
 622 to 627
 Drain Board Mats 395
 " Boards—Sink 394
 Drains—Floor..... 426, 484
 Surface 426
 Dressers—Plumbers 737
 Drift Plugs 738
 Drill Braces 736
 Drills—Breast 736
 Drinking Fountains 337, 338
 Drip Cup for Drinking Fountain..... 484
 Drivers—Screw 734
 Drop Elbows 579
 " Tees 584
 Drum Traps—Cast Iron 644
 Enameled 644
 Lead 467
 Dry Measure 821
 Duffy Sink Strainers..... 399
 Duplex Air Valves 520
 " Pipe Threading Machine 768
 " Stocks and Dies..... 769, 770
 " Testing Plugs 753
 " Wash Trays 411
 Durham Fittings 622 to 627
 Dusters—Plumbers 723

E

Eaves Trough 678
 Eccentrics—Fuller 502
 Eclipse Tapping Machine 776
 Eddy Siphon Jet Closet 40
 Edges—Plumbers' Side 737
 Eighth Bends—Soil Pipe 631
 Elbe Wash Down Siphon Closet..... 52
 Elbow Shears 762
 Elbows—Adjustable Conductor 681

D
E
F
G
H
I
J
K
L
M
N
O
P
Q
R
S
T
U
V
W
X
Y
Z

Elbows—Boiler 593
 Brass 606
 Cast Iron 607
 Corrugated Conductor 681
 Drainage 622, 623
 Long Radius, Cast Iron..... 618
 Malleable 576 to 579
 Railing 602
 Rubber 105
 Slip Joint, Flush Pipe..... 105
 Speaking Tube 682
 Supply Pipe, Slip Joint..... 491
 Union 593, 594
 " Radiator 542
 Elgin Adjustable Wrenches..... 799
 Emery Grinders 735
 Empire Bath Tub Seats 264a
 Enamel—Aluminum 695
 Bath Tub 695
 Black 694
 Enameled Iron Bath Tubs..... 164 to 193
 " " Closet Tanks 95
 " " " Bowls 88
 " " Drinking Fountains..... 337, 338
 " " Kitchen Sinks..... 377 to 393
 " " Lavatory 296 to 331
 " " Laundry Trays... 409 to 412
 " " Sink Backs..... 396, 397
 " " Slop Sinks..... 415 to 419
 " " Wash Sinks..... 332 to 336
 " " Water Closets..... 49 to 55
 Erie Unions 597
 Escutcheon Pins 677
 Escutcheons—Nickel Plated 490
 Expansion Bolts 152
 Extension Pieces—Brass..... 507
 Malleable 590
 Soil Pipe 639

F

Factory Wash Sinks 390
 Favorite Bath Tub Waste..... 205
 Fender Tips—Rubber 112
 Ferrules—Bent 476
 Brass 476
 " Trap Screw 476
 Iron " " 477
 Lead and Iron 469
 Ferrules and Bends 469
 Fidelity Steam Traps 570
 Fifth Bends—Soil Pipe 630
 Files 739, 740
 Filters—Water 715, 714a, 714b
 Fire Hose Valves 543
 " Hydrants 556 to 558
 " Pot Repairs 785, 786
 " Pots—Clayton & Lambert... 780, 781

Fire Pots—Coal Oil 779
 Gasoline 780, 781
 Sheet Iron 778
 Fish Traps 568
 Fittings—Brass Pipe 606
 Brass Stall 147 to 153
 Cast Iron Pipe 607 to 621
 Cast Soil Pipe 629 to 649
 Drainage 622 to 627
 Durham 622 to 627
 Malleable, Classification of 575
 " Pipe 576 to 605
 Overflow Bath Tub 206
 Railing 602 to 605
 Waste, Bath Tub 206
 Flanges—Bibb 490
 Brass for Iron Pipe..... 490
 " " Tubing ... 490
 Cast Iron 615
 Closet Floor 106
 Flanges—Railing 605
 Flange Unions 614
 Floats—Copper Ball 109, 492
 Glass Ball 109, 493
 Zinc Ball 109, 493
 Float Valves 521, 522
 Floor Chisels 726
 " Drains 426, 484
 " Plates 621
 " Slabs—Marble 290
 Flushometers—Closet 3 to 25
 Urinal 115
 Flush Pipe Collars 108
 " " Connections 105
 " " Elbows 105
 " " " —Rubber 105
 " " Slip Joint 105
 " " Posts 106
 " " Straps 106
 " Pipes—Closet 101
 Fluxes for Brazing and Soldering..... 814
 Folders—Roofing 718
 Folding Ship Lavatories..... 339 to 341
 Foot Baths—Enameled 193
 " —Porcelain 163
 " Rail Brackets 604
 Force Cups 729
 " Pumps—Plumbers' 803, 804
 Foster Ball Cocks 111, 522
 Fountain Brushes 266
 Fountains—Drinking 337, 338
 Fractional Parts of an Inch..... 820
 Frames—Hack Saw 756a
 Fuller Basin Cocks 342 to 345
 " Bath Bibbs 507
 " " Cocks 200, 201
 " Hose Bibbs 500, 501
 " Pantry Cocks 351
 " Plain Bibbs 499, 501

Furnaces—Plumbers', Primus 779
 " —Sheet Iron 778
 " Shampoo Cocks 346
 " Wash Tray Bibbs 512, 514

G

Galvanized Laundry Trays 414
 " Range Boilers 431 to 434
 " Sinks—Cast Iron 392
 " " —Steel 400, 402, 404
 Garden Valves 534
 Gas Brackets 495, 496
 " Cocks 494
 " Log Valves 538
 " Pendants 497
 " Pliers 751, 752
 " Tips 497
 Gaskets—Rubber Bath 362
 " Closet 106
 " Lavatory 362
 " Sink 362
 Gasoline Water Heaters 442, 443
 Gate Valves—Brass 544
 Flushometer 8
 Iron Body 545
 Ludlow 546 to 554
 Gauges—Testing Air 805
 " Mercury 805, 806
 " Spring 805
 Wire 742
 Giant Heaters—Primus 789
 Gila Wash Out Closet 53
 Glass Balls 109, 493
 Glasses—Looking, Plumbers' 741
 Globe Valves 536 to 539
 Gnu Wash Down Siphon Closet 36
 Gold Pin Radiators 457
 Goose Neck Connections 713
 " " Siphons 110
 Grates—Basin 482
 Sink 483
 Gratings—Sink 395
 Grease Interceptors 422
 " Traps 420 to 422
 Grinders—Emery 735
 Groovers—Hand 740
 Ground Key Ball Cocks 521
 Guides or Bushings for Pipe Stocks 775
 Gutter—Eaves 678
 " —Urinal Stall 147
 " Hangers 678, 679
 " Tongs 718

H

Hack Saw Blades 756a
 " " Frames 756a
 " Saws 756a

Half Y Branches 637, 638
 Hammers—Ball Pein 742
 Planishing 744
 Plumbers' 743
 Raising 744
 Riveting 743
 Setting 743
 Straight Pein 742
 Hand Groovers 740
 Handles for Compression Work 508
 " " Fuller Work 502
 Hangers—Expansion Pipe 620
 Gutter 678, 679
 Lavatory, Wall 363
 Hatchets 744
 Hawk's Bill Shears 760
 Head Rests—Bath Tub 264
 Heads—Bolt 151
 Conductor 681
 Nail 675
 Shower 228 to 230
 Headson Automatic Pipe Wrenches 801
 " Pipe Cutters 732
 Heaters—Menlo Tank 444
 Primus 789
 Water, Domestic 438
 " Gas 436 to 441
 " Gasoline 442, 443
 " Instantaneous 439 to 442
 Hilo Wash Out Closet 44
 Hinged Pipe Vises 794, 795
 Hinge Rubbers 112
 Hinges—Closet Seat 112
 " for Stalls 153
 " —Pipe, Gate 603
 H. M. & S. Ship Water Closets 79
 Holders—Bath Brush 242
 Cigar 261
 Comb and Brush, N. P. 246
 " " " Porcelain 263
 Match, N. P. 261
 " Porcelain 263
 Soap and Sponge 243, 244
 Soap and Tumbler 238 to 241
 Soap, Porcelain 262
 Sponge 242 to 245
 " Porcelain 262
 Toilet Paper, N. P. 256a, 257
 " " Porcelain 262
 Tooth Brush and Tumbler... 239 to 241
 " " 241
 " Powder 245
 Tumbler 238
 Wash Cloth 248
 Whisk Broom, N. P. 245
 " " Porcelain 262
 Holland Pipe Dies 774
 " Stocks and Dies 772, 774
 Hollow Punches 754
 Hook Plates 620

F
G
H
I
J
K
L
M
N
O
P
Q
R
S
T
U
V
W
X
Y
Z

Hooks—Chandelier 591
 Conductor Pipe 681
 Gas Pipe 650
 Nickel Plated 255
 Plumbers' 650
 Pot 739
 Ring Pipe 620
 S..... 109
 Shave 739
 Single Pipe 620
 Soil Pipe 650
 Hopper Valve Closets 90, 91
 " Valves 517
 Hoppers—Closet, Colma 86
 " Enameled, Oval 89
 " " Round 89
 " Jersey 87
 " New Pattern 93
 " Philadelphia 93
 " Porcelain, Oval 87
 " " Round 87
 " Ship 92
 " Short, Enameled 93
 " " Porcelain 85
 " Siphon Jet 83
 " Townsend 86
 Slop, Baily 423
 " Champion 423
 " Marquis 423
 " Menlo 424
 Horizontal Range Boilers 434
 " Check Valves 540
 " Tee Y Branches 635
 Hose Bibb Ends 712
 " Bibbs—Compression 504, 506
 " —Fuller 500, 501
 " —Lever 511
 " —Cotton 700
 " —Rubber 698 to 700
 " Bushings 711
 " Clamps 709, 710
 " Couplings 709
 " Fire Valves 543
 " Gas Cocks 494
 " Menders 710, 711
 " Nipples 712
 " Pipes 702 to 704
 " Pipe Tips 702
 " Racks 714
 " Reducers 712
 " Sprinklers 702, 703
 " Washers 709
 Hubs—Saddle 641
 Soil Pipe 643
 Hydrant Cesspools 426
 " Clamps 592
 Hydrants—Fire 556 to 558
 Wharf 543
 Hydrostatic Table 825

I

Elliptical Traps 355
 Imperial Cement 696a
 " Union Radiators 453
 Increases—Drainage 623
 Soil Pipe 642
 Independent Gas Cocks 494
 Indirect Radiators 457
 Individual Bowl Closet Range..... 61 to 63
 Indus Siphon Jet Closet 49
 Inlet Connections—Urinal 144, 145
 Instantaneous Water Heaters.... 439 to 442
 Interceptors—Grease 422
 Inverted Y Branches 636
 Iron—Corrugated 673, 674
 " —Sheet 670 to 672
 " Ferrules 477
 Irons—Round 730

J

Jack Chain 487
 Jaws—Yankee, Pipe 800
 Jeffress Cocks 532
 Jenkins' Angle Valves 539
 " Check Valves 540
 " Globe Valves 539
 Jersey Hopper 87
 Joint Runners 755
 Joints—Ball and Sockets..... 230
 Elbow Slip 491
 Insertable 649
 Straight Slip 204
 Jumbo Siphon Jet Closet 12

K

Kelly Automatic Closet 56
 " Frost-Proof Closet 57, 58
 Keystone Pipe Vise 794
 Knickerbocker Fountain Brushes 266
 Knives—Chipping 745
 Knock-About Pump Closet 78

L

Ladles—Melting 745
 Lantern Chisels 724
 Latona Siphon Jet Closet 10
 Lava Gas Tips 497
 Lavatory and Sink Combinations..... 325
 " Bowls 291 to 295
 " Brackets 368 to 370
 " Gaskets 362
 " Legs 364 to 367

Lavatory Plugs 361
 " Sets 263
 " Supply Pipe 352, 353
 " Trap 355 to 357
 " Wall Hanger 363
 " Wastes 354
 Lavatories—Barber, Enameled 327
 " Marble 284, 285
 Enameled 296 to 331
 " Sectional 324 to 331
 Folding 339 to 341
 Marble 274 to 285
 Prison 54a, 323
 Ship, Enameled 322
 " Folding 339 to 341
 Solid Porcelain 269 to 273
 Laundry Trays 406 to 414
 Lawn Sprinklers 704 to 708
 Lawson Gasoline Water Heaters 443
 " Thermostatic Valve 437
 " Water Heaters—Gas 436
 " " " —Gasoline 443
 L Burner Cocks 494
 Leader Pipe 680
 Lead and Iron Bends and Ferrules 469
 " " " Ferrules 469
 Lead Bends 468
 " Pipe 471
 " " Cutter 731
 " Solder Nipples 470
 " Soil Pipe 471, 472
 " Tacks 470
 " Traps 463 to 467
 " Washers 676
 " —Bar and Sheet, Table of Weights 814
 Bar 689
 Caulking 689
 Pig 689
 Sheet 472
 Leathers—Cup 110
 Legs—Brass Stall 149, 150
 Lavatory 364 to 367
 Lever Hose Bibbs 511
 " Plain Bibbs 509, 510
 " Shower Stops 528
 " Stops 526-527
 " Wash Tray Bibbs 512
 Levers—Ball Cock 110
 Closet Tank 110
 Lincoln Kitchen Sinks 376
 " Laundry Trays 407
 Links—Split 489
 Liquid Measure 820
 Lock Cocks 513
 " Nuts—Brass 606
 " " —Cast Iron 612
 Closet Tank 110
 Malleable 591
 Long Measure 819
 Look Glass—Plumbers' 741

Loose Key Compression Stops 524
 Low Down Closet Tanks 96
 Ludlow Fire Hydrants 556 to 558
 " Float and Air Valves 555
 " Gate Valves 546 to 554
 Lyon Snips 758

M

Machines—Pipe Threading, Bignal & Keller 766 to 768
 Pipe Threading, Duplex 768
 " " Oster 763 to 765
 " " P. D. Q. C. 767
 " Tapping 776, 777
 Male and Female Unions 596
 " Unions 596
 Malleable Pipe Fittings 576 to 605
 Mallets 737
 Marble 290
 " Backs and Aprons 290
 " Floor Slabs 106, 290
 " Lavatories 274 to 285
 " Sink Slabs 290
 " Slabs—Basin 286 to 290
 " Partitions 290
 " Wainscoting 290
 Marine Closets 68 to 79
 Marquis Slop Hoppers 423
 Match Holders—Nickel Plated 261
 Porcelain 263
 Match Scratches 261
 Mats—Bath, Cork 265
 " Tub, Rubber 265
 Drain Board, Rubber 395
 Sink, Wood 395
 McKercher Wrenches 800
 Measure—Apothecaries' 821
 Cubic 819
 Dry 821
 Liquid 820
 Long 819
 Metric 822, 823
 Nautical 820
 Square 819
 Measures—Miscellaneous 820
 Melting Ladles 745
 Menders—Hose 710, 711
 Menlo Boiler Stands 435
 " Lavatory Wastes 354
 " Roofing Tin 686
 " Slop Hoppers 424
 " Snips 757
 " Tank Heaters 444
 Mensuration of Solids 824
 " Surfaces 824
 Mercer Boilers 448 to 451
 Mercury Test Gauges 805, 806
 Metal—Babbit 691, 692

I
J
K
L
M
N
O
P
Q
R
S
T
U
V
W
X
Y
Z

Metals—Melting Point of	814
Meter Cocks	532
Meters—Water	560 to 566
Metric Weights and Measures.....	822, 823
Milk Cocks	519
Mill Board—Asbestos	693
Milwaukee Basin Cocks	350
Mirrors—Adjustable	258, 260
Plate Glass	258 to 260
Miters—Eave Trough	679
Monarch Combination Stop and Waste..	528
“ Compression Basin Cocks	348
“ “ Bibbs	506
“ “ Stops	524
“ Fuller Basin Cocks	342
“ “ Bibbs	501
“ Wash Tray Bibbs	514
Monkey Wrenches	799
Moore's Basin Cocks	350
“ Bibbs	515
Moldings for Marble Slabs	289
Moulds—Solder	746
Mouthpieces—Speaking Tube	683
Mueller Corporation Cocks	533
Muriatic Acid	692

N

Nail Heads	675
National Unions	597
Nails—Roofing	676
Naugatuck Balls	492
Nautical Measure	819
Neck Showers	232
Necks—Stork	498
Needle Shower Baths	214 to 217
Nemo Hopper Closet.....	55
Neptune Jr. Pump Water Closets.....	70, 71
“ Pump Water Closets.....	68, 69
Never Split Closet Seats.....	99
New Dome Siphon Jet Closet.....	38
New Era Sink Brackets	403
“ “ Steel Sinks	402, 404
New Gem Siphon Jet Closet.....	28
Nippers—Cutting	747
Nipples—Brass	606
Hose	712
Solder, Brass	473
“ Lead	470
Wrought	600, 601
Non-Rusting Roofing Tin	687
Nozzles—Hose	702 to 704
Nuts—Brass	151
Slip Joint	477
Waste, Malleable	592
Nye Pipe Dies	773

O

Oakum	651
Offsets—Malleable	591

Offsets—Soil Pipe	640
Ohio Sink Traps	360
Oil Cocks—Compression	519
Oilers	748, 749
Oil—Three in One	696
Oster Pipe Threading Machines.....	763 to 765
Outlet Connections—Urinal	144, 145
Outlets—Eaves Trough	679
Overflow Bath Tub Fittings	206
Oxus Wash Down Siphon Closet	50

P

Pacific Ship Water Closet	73
Packing Chisels	728
“ —Rubber	652
Wick, Asbestos	693
Painters' Torches	788
Pans—Closet, Copper	108
Pantry Cocks	351
“ Sinks—Copper	405
“ “ —Porcelain	375
“ “ —Steel	405
Paper—Asbestos	693
Parker's Combination Vises.....	792, 793
“ Parallel Vise	791
Parson's Trough Closets	59, 60
Partitions—Marble	290
Paste—Pipe Joint	696a
Polishing	695, 697
Patches—Hose	710
Payne's Corporation Cocks	533
Peerless Aluminum Enamel	695
“ Iron Enamel	694
Pendants—Gas	497
Philadelphia Hopper	93
Pieces—Extension, Brass	507
“ “ Malleable	590
“ “ Soil Pipe	639
Mouth, Speaking Tube	683
Pig Lead	689
Pillars—Brass	494
Pinal Hopper Closet	48
Pin Radiators	457
Pins—Bending	752
Turn	738
Pipe Bands	641
“ Benders	722, 723
“ Cutters	732, 733
“ Hangers	620
“ Hooks—Cast Iron	620
“ “ —Conductor	681
“ “ —Soil	650
“ Joint Paste	696a
“ Reamers	775
“ Saddles	615
“ Straps	650
“ Tapping Machines	676, 677
“ Taps	775
“ Threading	574

Pipe Threading Machines763 to 768
 " Tongs 796
 " Wrenches797 to 802
 " —Brass 663
 Cast Soil 628
 Conductor 680
 Dipped 574
 Gas573, 574
 Lead 471
 " Soil 471, 472
 Tin 472
 Wrought 573
Pipes—Blow 752
 Closet Flush 101
 " Supply 101
 Hose702 to 704
 Supply, Bath 204
 " Lavatory 352, 353
 Urinal Waste 145
 " Wash Down 147
 Waste, Continuous 359
Placer Laundry Trays 408
Plain Bibbs—Compression503, 505, 506
 Fuller499, 501
 Lever509, 510
Plain Couplings 475
Plates—Bench 716
 Box 498
 Ceiling 621
 Cesspool 427
 Floor 621
 Hook 620
Plugs and Couplings for Enameled Bath
 Tubs 206
 " —Basin, Cast Brass480, 481
 " Stamped Brass 479
 Bath, Cast Brass480, 481
 " Stamped Brass 479
 Brass, Pipe 606
 Cast Iron 613
 Drift 738
 Lavatory 361
 Malleable 599
 Rubber 482
 Sink, Cast Brass480, 481
 " Stamped Brass 479
 Soil Pipe 644
 Testing752, 753
 Wash Tray, Cast Brass480, 481
 " Stamped Brass 479
 Waste 475
Plumb Bobs 721
Plumbers' Friend 729
 " Hooks 650
 " Soil 651
Plyers750 to 752
Polish—Bar 697
 " —Brilliantshine 697
 " for Enameled Ware 694
 " —Metal695 to 697

Polish—Sunshine 696
 Universal 695
 Polishing Paste695 to 697
Pomona Roofing Tin 687
Porcela 694
Porcelain Bath Tubs157 to 163
 " Kitchen Sinks373, 374
 " Laundry Trays 406
 " Lavatories269 to 273
Portable Shower Baths 222a, 223
Posts—Flush Pipe 106
 Supply Pipe 106
Pot Hooks 739
Pots—Fire778 to 781
 Solder 745
Pressure Regulators 559
Prick Punches 754
Primus Fire Pots 779
 " Furnaces 779
 " Heaters 789
 " Torches787, 788
Princess Union Radiators 454
Prison Closet and Lavatory 54a
Prison Lavatories54a, 323
Properties of the Circle 824
Public Urinals115 to 136
Pulls—Closet Tank 109
Pumps and Gauges 805
 " —Plumbers' Force803, 804
 Testing 805
Punches and Chisels 753
 " —Hollow 754
 Prick 754
 Solid 753
Push and Pull Valves 517

Q

Quarter Bends—Soil Pipe629, 630
 " Circle Slabs—Marble 286

R

Racking Cocks 518
Racks—Hose 714
Radiation—Cubic Feet of Air One Foot
 Will Heat 826
Radiator Elbows 542
Radiators452 to 460
 Regular Tapping 458
Radiator Valves541, 542
Railing Fittings602 to 605
Railroad Freight Classification.....827, 828
Rails—Bath Tub Hand.....247
 Shelf254a
Rainier Wash Out Closet 45
Raised Brass Strainers 483
Ramona Siphon Jet Closet 26

N
O
P
Q
R
S
T
U
V
W
X
Y
Z

Range Boilers	431 to 434
" Closets—Brighton	64 to 67
Individual Bowl	61 to 63
Parson's	59, 60
Siphon Education	58a, 58b
Rapid Instantaneous Water Heaters	439
Rasps	740
Ratchet Stocks and Dies	770, 774
Reamers—Pipe	775
Receipts, etc.	815, 816
Receptors—Shower Bath, Enameled	213
Shower Bath, Porcelain	209 to 212
Reducers—Brass	606
Cast Iron	612
Hose	712
Malleable	586
Soil Pipe	642
Registers—Meter	567
Regulators—Water Pressure	559
Repairer—Closet	108
Repairs—Fire Pot	785, 786
Torch	786
Rests—Cigar	261
Soil Pipe	644
Return Bends—Cast Iron	616
Malleable	588, 589
Ridge Cap	674
Rings—Boiler	434
Curtain	233
Rubber, Slip Joint	362
Shower	232, 232a
Siphon, Rubber	110
Rivets and Burrs—Number to the Pound	814
" —Copper	656
" —Tinners'	656 to 658
Rivet Sets	754
Rod—Brass, Threaded	151
Rods—Bronze	667
Roofing—Corrugated	673, 674
" Material and Labor	817, 818
" Folders	718
" Double Seamers	716, 719
" Nails	676
" Tin	686, 687
" Tongs	717, 718
Rosalia Siphon Jet Closet	9, 13, 14, 17
Rosin	692
Round Irons	730
" Nose Chisels	725
" Way Stops	529
Royal Roofing Tin	686
" Union Radiators	452
Rubber Bath Tub Mats	265
" Bumpers	112
" Packing	652
" Stoppers	482
Rubbers—Hinge	112
Rules—Tinners'	755
Runners—Joint	755
Rush Siphon Jet Closet	39

S

Saddle Hubs—Soil Pipe	641
Saddles—Pipe	615
Safety Chain	488
Safe Wastes	482
Salts—Soldering	692
Sand's Pump Water Closet	76
Sanitary Tees—Soil Pipe	633 to 635
Saunders' Pipe Cutters	733
" " Vise	795
Saws—Compass	756
Double Edge	756
Hack	756a
Single Edge	756
Scepter Radiators	456
Scott Gate Valves	545
Scratch Awls	719, 720
Scratches—Match	261
Screwdrivers	734
Screws—American Long	599
Ball Cock	110
Closet	107
Deck	475
Trap	475
Seamers—Roofing	716, 719
Seat Brackets	370
Seats—Bath Tub	264, 264a
Closet	97 to 100
Never-Split, Closet	99
Siphon	110
Sectional Lavatories	324 to 331
Self-Closing Basin Cocks	349, 350
" Bibbs	515, 516
" Cooler Cocks	516
" Stops	525
Sets—Lavatory	263
Rivet	754
Service Clamps or Saddles	615
" Cocks—Brass	530, 531
" " —Iron	531
Sewer Valves	648a
Shampoo Cocks	346
" Sprays	231
Shampoos	227
Shave Hooks	739
Shears and Crimpers	760, 761
" —Bench	762
Double Cutting	761
Elbow	762
Hawk's Bill	760
Tinners' Hand	757 to 759
Sheet Brass	664
" Copper	665, 666
" Iron	670 to 672
" " Fire Pots	778
" Lead	472
" Tin	472
" Zinc	687, 688
Sheffy Pipe Wrench	798

Shelf Rails254a
 Shelves—Towel, Nickel Plated..... 250
 Towel, Opal Glass..... 254
 “ Plate Glass 253, 254
 Ship Closet—Atlantic 74
 Columbia 72
 Dandy 77
 Delaware 75
 H. M. & S..... 79
 Knockabout 78
 Neptune 68, 69
 “ Jr..... 70, 71
 Pacific 73
 Sand’s 76
 Ship Lavatories—Enameled 322
 Folding 339 to 341
 Shower Bath Receptors209 to 213
 “ Curtains 233
 “ Baths 214 to 226
 “ —Portable222a, 223
 “ Curtain Snaps 233
 “ Heads228 to 230a
 “ Rings 232, 232a
 Showers—Neck 232
 Sidewalk Box Covers 428
 “ Boxes 428
 Single Hubs 643
 Sill Cocks 535
 Sink and Wash Tray Combinations.. 386, 387
 Sink Backs—Cast Iron, Enameled... 396, 397
 “ —Steel 404
 “ Bolts 398
 “ Brackets—Brass 398
 “ —Campbell 397
 “ —Enameled 398
 “ —New Era 403
 “ —Painted 398
 “ Connections 361
 “ Couplings 399, 401, 403
 “ Drain Boards 394
 “ Gaskets 362
 “ Grating 395
 “ Mats 395
 “ Plugs 479 to 481
 “ Strainers 399, 401, 403
 “ Traps 358 to 360
 Sinks—Enameled Corner 393
 “ Half Circle 393
 “ Patent Overflow..... 392
 “ Kitchen, Flat Rim.391, 392
 “ With Drain Board.379-385
 Factory Wash 390
 Galvanized392, 400, 402, 404
 Kitchen, Columbus 400
 “ Enameled377 to 393
 “ New Era 402, 404
 “ Porcelain 372 to 376
 Pantry, Copper 405
 “ Porcelain 375
 “ Steel 405

Sinks—Slop, Enameled415 to 419
 “ Painted 419
 Wash, Enameled 332 to 336
 Siphon Education Closet Range..... 58a, 58b
 “ Rings 110
 “ Seats 110
 Siphons—Goose Neck.....110
 Sisson Insertable Joints 649
 Sitz Baths—Enameled190 to 192
 Porcelain 162
 Sixteenth Bends 632
 Sixth Bends 631
 Slabs—Marble, for Closet 106
 Marble 290
 Slab Zinc 639
 Sleeves—Brass 477
 Cast Iron 643
 Slip Joint Angle Supply Valves..... 103
 “ Closet Supplies 102
 “ Flush Pipe Elbows 105
 “ Lavatory Plugs 361
 “ Nuts 477
 “ Rings 362
 “ Straight Supply Valves 103
 “ Supply Pipe Elbows 491
 Slip Joints—Elbow 491
 Straight 204
 Slop Hoppers423, 424
 “ Sinks 415 to 419
 Snaps—Chain 439
 Curtain 233
 Snips—Circular 759
 Tinnors’ 757 to 759
 Soap and Tumbler Holders..... 238 to 241
 “ “ Sponge Holders243, 244
 “ Dishes—Marble 289
 Nickel Plated 234 to 244
 Porcelain 262
 Soap Holders—Porcelain 262
 Sockets—Boiler 593
 Malleable 587
 Wrought 587
 Soil Brushes 723
 “ Cups 728
 “ Pipe Fittings 629 to 649
 “ “ Hooks 650
 “ “ Straps 650
 “ “ —Cast 628
 “ “ —Lead 471, 472
 Soil—Plumbers’ 651
 Solder Coppers729, 730
 “ Copper Handles 730
 “ Moulds 746
 “ Nipples—Brass 473
 “ —Lead 470
 Solder Pots 745
 “ Unions 473
 Soldering Salts 692
 Solder—Electric 691
 Spelter 690

S
T
U
V
W
X
Y
Z

Solder—Tinner's	690
Wiping	691
Wire	690
Solid Punches	753
Sonoma Closet	16
Sovereign Union Radiators	457
Speaking Tube Elbows	682
" Tube	682
Specific Gravity	810
" " of Various Materials ..	810
" " " Liquids	811
" " " Metals	811
" " " Timber	811
Spelter—Slab	689
" Solder	690
Split Links	489
Sponge and Bath Brush Holders ..	242 to 244
" Holders—Nickel Plated ...	242 to 245
" " —Porcelain	262
Sprays—Bath	231, 233
Bath Massage	232a
Shampoo	231
Sprinkler Heads	230
Sprinklers—Hose	702 to 704
Lawn	704 to 708
Square Measure	819
Stall Bolts	151
" Clamps	147, 148
" Door Bolts	153
" " Stops	153
" Hinges	153
Stalls—Urinal	115 to 128
Standards—Brass Railing	149, 150
Stands—Boiler Adjustable	435
Boiler Lockwood	435
" Menlo	435
Hose	708
Stanwood Pipe Cutter	733
Stays—Chain	484 to 486
Steam Traps	570
Steel Bath Tubs	196 to 198
" Sinks—Columbus	400, 405
New Era	402, 404
Stems and Balls—Fuller	502
" —Float or Ball	110
Stench Traps	426
Sticks—Bossing	738
Stillson Pipe Wrenches	797
Stocks and Dies	769 to 794
Armstrong	771
Duplex	769, 770
Holland	772, 774
Ratchet	770, 774
Stops and Waste	527 to 529
Stop Cocks	523 to 529
Gas	494
Stoppers—Rubber	482
Stops—Compression	523, 524
Doherty	525
Door	153

Stops—Lever Handle	526, 527
" Shower	528
Loose Key	524
Moore's	525
Round Way	529
Tee Handle	529
Stork Necks	498
Stove Bolts	655
Strainers—Conductor	682
Convex	478
Fancy	478
Plain	478
Raised	483
Urinal Trough	483
Water Meter	568
Straps—Bath Tub	264
Flush Pipe	106
Hose	710
Supply Pipe	106
Street Elbows	578
" Washer Boxes	428
" Washers	713
Suggestions for Architects	18
Sunburst Shower Baths	222a
Sunshine Polish	696
Supplies—Slip Joint	102
Supply and Waste Fittings	207
" Pipe Elbows	491
" " Posts	106
" " Straps	106
" Pipes—Bath	204
" " —Closet	101
" " —Lavatory	352, 353
Supply Valves—Angle	103, 104
Slip Joint	103
Supports—Apron	368
Sure Grip Bulbs	231
Surface Drains	426
Swing Basin Cocks	346
" Towel Bars	250a, 251

T

Tack Bumpers	112
Tacks—Lead	470
Tin	677
Tank Board Clamps	109
" Boards	109
" Brackets	370
" Heaters—Menlo	444
" Lock Threads	599
Tanks—Closet, Parts of	109, 110
Hot Water	434
Rectangular, Capacity of	808
Round, Capacity of	807
Urinal, Automatic	146
Water Closet	94 to 96
" " Enameled	95
" " Low Down	96

Tap Borers721, 722
 Tapping Machines776, 777
 Taps—Pipe 775
 Tee Handle Stops 529
 Tees—Brass 606
 Branch 619
 Cast Iron608 to 610
 Closet 625
 Drainage 623
 Hand Rail 603
 Long Radius 618
 Malleable581 to 584
 Railing 602
 Soil Pipe632 to 635
 Union 595
 Telegraph Basin Cocks 350
 " Bibbs 516
 " Cooler Cocks 516
 Testing Plugs752, 753
 " Pumps 805
 Thatcher Basin Cocks 349
 Threading Pipe 574
 Threads—Number to an Inch..... 814
 Tank Lock 599
 Three in One 696
 Throttle Valves 544
 Tiber Wash Down Siphon Closet..... 11
 Tigris Siphon Jet Closet 51
 Tin—Bar 690
 Charcoal Sheet684 to 687
 Coke685, 686
 Perforated 659
 Pig 690
 Roofing686, 687
 Sheet 472
 Tin Pipe 472
 Tinnerns' Rules 755
 " Snips757 to 759
 " Vises 791
 Tips—Gas 497
 Tobin Bronze 667
 Togo Wash Down Siphon Closet 43
 Toilet Paper Boxes 256
 " " Holders257, 262
 Tong—Crimping 762
 Gutter 718
 Pipe 796
 Roofing717, 718
 Tool Bags 721
 Tooth Brush and Tumbler Holders.239 to 241
 " " Holders 241
 " Powder Receptacles 245
 Torch Repairs 786
 Torches—Braziers'781 to 787
 Clayton & Lambert.....780 to 783
 Coal Oil787, 788
 Gasoline780 to 785
 Painters'..... 788
 Plumbers' 741
 Primus787, 788

Torches—Vulcan 784
 Torrance Basin Cocks 342
 Towel Bars247 to 253
 " Baskets246a, 247
 " Shelves—Nickel Plated 250
 " " —Opal Glass 254
 " " —Plate Glass253, 254
 Townsend Closet 86
 Trap Covers 643
 " Screw Ferrules—Brass 476
 " " " —Iron 477
 Trap Screws 475
 " With Floor Drain 426
 Traps—Bag 355
 Bath Tub 206
 Bell 484
 Drainage 627
 Drum, Cast Iron 644
 " Enameled 644
 " Lead 467
 Fish 568
 Grease420 to 422
 " Enameled 420
 " Iron, Painted 420
 " " Stone 421
 " Nickel Plated 421
 Lavatory355 to 357
 Lead463 to 467
 Sink358 to 360
 Soil Pipe645 to 648
 Steam 570
 Stench 426
 Urinal 144
 Trays—Laundry 406 to 414
 " Cement 413
 " Enameled409 to 412
 " Galvanized414
 " Lincoln 407
 " Placer 408
 " Porcelain 406
 Trimmings for Compression Work.... 508
 " " Fuller Work 502
 Trim Basin Wrench 802
 " Pipe Wrench 797
 Tripod—Hose 708
 Trough Closet—Parson's59, 60
 Eaves 678
 Troy Weight 821
 Tube—Speaking 682
 Tubing—Brass662, 663
 Rubber 701
 Tubs—Bath, Iron Enameled164 to 193
 " Solid Porcelain157 to 163
 " Steel, Copper Lined..... 196
 " " Enameled197, 198
 " Zinc 199
 Tumbler Holders 238
 Tuma Closet 15
 Turn Pins 738

U

Union Boiler Sockets	593
“ Elbows	594
“ Radiator Valves	542
“ Tees	595
Unions—Brass	606
Erie	597
Flange	614
Malleable	596, 597
National	597
Solder	473
Universal Soil Pipe Plugs	752
Upright Y Branches	634a
U. S. Gate Valves	544
Urinal Baskets	145
“ Cocks	142, 143
“ Inlet Connections	144, 145
“ Outlet “	144, 145
“ Stall Gutters	147
“ Stalls	115 to 128
“ “ —Porcelain	127, 128
“ Tanks	146
“ Traps	144
“ Wash Down Pipes	147
“ Waste Pipes	145
Urinals—Corner	140, 141
Enameled	141
Flat Back	139, 141
Lipped	139 to 141
Pedestal	137
Porcelain	139, 140
Public	129 to 136
Siphon Eduction	129 to 132
“ Jet	138
Speakman	124 to 126
Wash Out, Public	133 to 135
Urn Cocks	519

V

Valve Boxes—Adjustable	555
Valves—Angle	536 to 539
Angle Supply	104
Back Water	648a
Check	540
Closet, Flushometer	7
Float	521, 522
Flushometer	8
Garden	534
Gas Log	538
Gate, Brass	544
“ Flushometer	8
“ Iron Body	545
Globe	536 to 539
Hopper	79, 517
Hose	543
Jenkins	539

Valves—Ludlow, Air	555
“ Float	555
“ Gate	546 to 554
Pump	660
Push and Pull	517
Quick Opening	550
Radiator, Detroit	541
“ Jenkins	542
Sewer	648a
Sliding Stem	550
Thermostatic, Lawson	437
Throttle	544
Varnish—Asphaltum	694
Ventilating Boxes	427
“ Branches—Soil Pipe	638
“ Caps	642
Vertical Check Valves	540
Vises—Angle Plate	793
Armstrong	795
Chain	790
Combination, Parker's	792, 793
Diamond	790
Hinged, Pipe	794, 795
Keystone, Pipe	794
Parker's	791 to 793
Parallel	791
Pipe	790 to 795
Saunders Pipe	795
Tinnars	791
Vulcan Chain	790
With Drilling Attachment	790
Volga Wash Down Siphon Closet	42
Vulcan Chain Pipe Vises	790
“ “ Tongs	796
“ Torches	784

W

Wainscoting—Marble	290
Wall Registers	457
Warnock Wrenches	802
Wash Cloth Holders	246
“ Down Pipes	147
Washer Cutters	731
Washers and Waste	475
Basin Cock	362
Bibb	508
Buggy	714
Closet	107
Hose	709
Lead	676
Nickel Plated	151
Slip Joint Rubber	362
Street	713
Waste, rubber	362
Wash Sinks—Enameled	332 to 336
Painted, Factory	390
Wash Tray Bibbs	512 to 514

Wash Tray Bibbs—Monarch 514
 “ “ Chains 489
 “ “ Plugs 479 to 481
 “ Trays—Laundry 406 to 414
 Waste—Cotton 651
 “ Nuts—Malleable 592
 “ Pipes—Continuous 359
 “ Plugs 475
 “ Washers 362
 Wastes and Washers 475
 Wastes—Bath Tub 205 to 207
 Lavatory 354
 Safe 482
 Water Boilers 445 to 451
 Water Closet—Ajax 47
 Alameda 46
 Alfa 32
 Alma 34
 Anti-freezing 57, 58
 Atlantic 74
 Auto 54
 Boston 30
 Brighton 64 to 67
 Chino 41
 Columbia 72
 Dandy 77
 Delaware 75
 Eddy 40
 Elbe 52
 Flushometer 3 to 25
 Gila 53
 Gnu 36
 Hilo 44
 H. M. & S. Ship 79
 Individual Bowl 61 to 63
 Indus 49
 Jumbo 12
 Kelly 56 to 58
 Knockabout 78
 Latona 10
 Nemo 55
 Neptune 68, 69
 “ Jr 70, 71
 New Dome 38
 New Gem 28
 Oxus 50
 Pacific 73
 Parsons 58, 59
 Pinal 48
 Prison 54a
 Rainier 45
 Ranges 58a to 67
 Range, Brighton 64 to 67
 “ Individual Bowl 61 to 63
 “ Parson’s 58, 59
 “ Siphon Education 58a, 58b
 Ramona 26
 Rosalia 9, 13, 14, 17
 Rush 39
 Sands 76

Water Closet—Sonoma 16
 Tiber 11
 Tigris 51
 Togo 43
 Tuma 15
 Volga 42
 Water Closet Bowls 82 to 88
 “ “ Tanks 94 to 96
 “ “ “ —Enameled 95
 “ “ “ —Low Down 96
 “ Filters 714a to 715
 “ Heaters—Crescent 440, 441
 Instantaneous 439 to 442
 Lawson, Gas 436
 “ Gasoline 443
 Menlo 444
 Rapid 439
 Water Meters 560 to 566
 Weight—Apothecaries 821
 Avidupois 821
 Metric 822, 823
 Troy 821
 Weight of Block Tin Pipe 813
 “ “ Copper—How to Obtain 812
 “ “ Iron—How to Obtain 812
 “ “ Liquids 811
 “ “ Lumber 812
 “ “ Metals 811
 “ “ Sheet Copper 812
 “ “ Timber 811
 “ “ Various Materials 810
 Weights—Miscellaneous 812
 Table of 813
 Wharf Hydrant 543
 Whisk Broom Holders 245, 262
 Whistles—Speaking Tube 683
 Wing Dividers 734
 Wiping Cloths 728
 “ Solder 691
 Wire Chisels 724
 “ Gauges 742
 “ Solder 690
 “ —Brass 662
 Copper 662
 Iron 660, 661
 Wood and Stone Measure 819
 “ Chisels 726
 Wrenches—Alligator 799
 Atlas 798
 Basin 802
 Black Screw 799
 Elgin 799
 For N. P. Tubing 802
 Headson 801
 McKercher 800
 Pipe 797 to 802
 Sheffy 798
 Stillson 797
 Trimo 797

Wrenches—Warnock	802
Wrights'	798
Wright's Pipe Wrenches.....	798
Wrought Pipe	573

X

X-Ray Radiators	457
-----------------------	-----

Y

Yankee Jaws	800
Yarning Chisels	728

Y Branches—Cast Iron	617
Drainage	624
Malleable	580
Soil Pipe	636 to 638
Y'S—Cast Iron.....	617
Drainage	624
Malleable	580
Soil	636 to 638

Z

Zinc Bath Tubs	199
" Balls	109, 493
" —Gauges of	688
Sheet	687, 688
Slab	689

Suggestions for the Arrangement
OF
MODERN BATHROOMS



HOLBROOK, MERRILL & STETSON

INCORPORATED.

SAN FRANCISCO, LOS ANGELES AND NEW YORK.

BATHROOM DESIGN A.

Illustrated on Next Page.

CLOSET—Holbrook, Merrill & Stetson, 94-C, Tigris Porcelain Enameled inside and outside; Siphon Jet Bowl with Oak Seat and Cover, Oak Zinc-lined Tank and Nickel-Plated Angle Supply with Nickel-Plated Slip Joint Valve..... \$ 29.50

BATH—Holbrook, Merrill & Stetson, 5-foot, 622-C, 4¾-inch Roll Rim, Porcelain Enameled Bath, with Exterior finished in No. 1 Zinc White and 666-C "Festoon" Border, with Nickel-Plated Imperial Bell Supply and Waste Fittings..... 105.50

SHOWER BATH AND RECEPTOR—Nickel-plated Combination Shower and Needle Bath, with Liver Sprays, Mixing Chamber, Thermometer and Rubber Curtain; Holbrook, Merrill & Stetson, 730-C Porcelain Enameled 36x36-inch Receptor, with Exterior finished in No. 1 Zinc White and 666-C "Festoon" Border..... 222.00

SITZ BATH—Holbrook, Merrill & Stetson, 659-C, 3-inch Roll Rim, Porcelain Enameled Sitz Bath, with 5-inch Extension Arm on sides and Nickel-Plated Imperial Five-valve Bell Supply and Waste Fittings, with Liver Spray and Bidet, Exterior finished in No. 1 Zinc White and 666-C "Festoon" Border..... 108.75

NOTE—Sitz Bath shown in Bathroom Design A, is 695-C, except with Five-valve Imperial Bell Supply and Waste Fittings and Liver Spray and Bidet, instead of regular pattern of Bell Supply and Waste Fittings for Hot and Cold Water.

FOOT BATH—Holbrook, Merrill & Stetson, 660-C, 2½-inch Roll Rim, Porcelain Enameled Foot Bath, with Exterior finished in No. 1 Zinc White and 666-C "Festoon" Border, with Nickel-Plated Imperial Bell Supply and Waste Fittings..... 47.50

LAVATORY—Holbrook, Merrill & Stetson, 1068-C, 22x33 Porcelain Enameled Lavatory and Pedestal, Enameled all over, with Nickel-Plated "Colonial" Pattern Monarch Fuller Basin Cocks with China Handles marked Hot and Cold, Nickel-plated Supply Pipes, Trap and Waste to wall..... 49.50

MISCELLANEOUS TRIMMINGS—All Brass Nickel-Plated:

3-Arm Swing Towel Bar, 912-C..... 1.75
 Glass Bath Bar, 24 inches long, 920-C..... 3.00
 Towel Basket, 889-C..... 11.00
 Sponge Holder, 878-C..... 1.60
 Bath Tub Soap Dish, 843-C..... 1.60
 Toilet Paper Holder, 946-C..... 1.35

Total Approximate Cost..... \$583.05

BATHROOM INTERIORS.

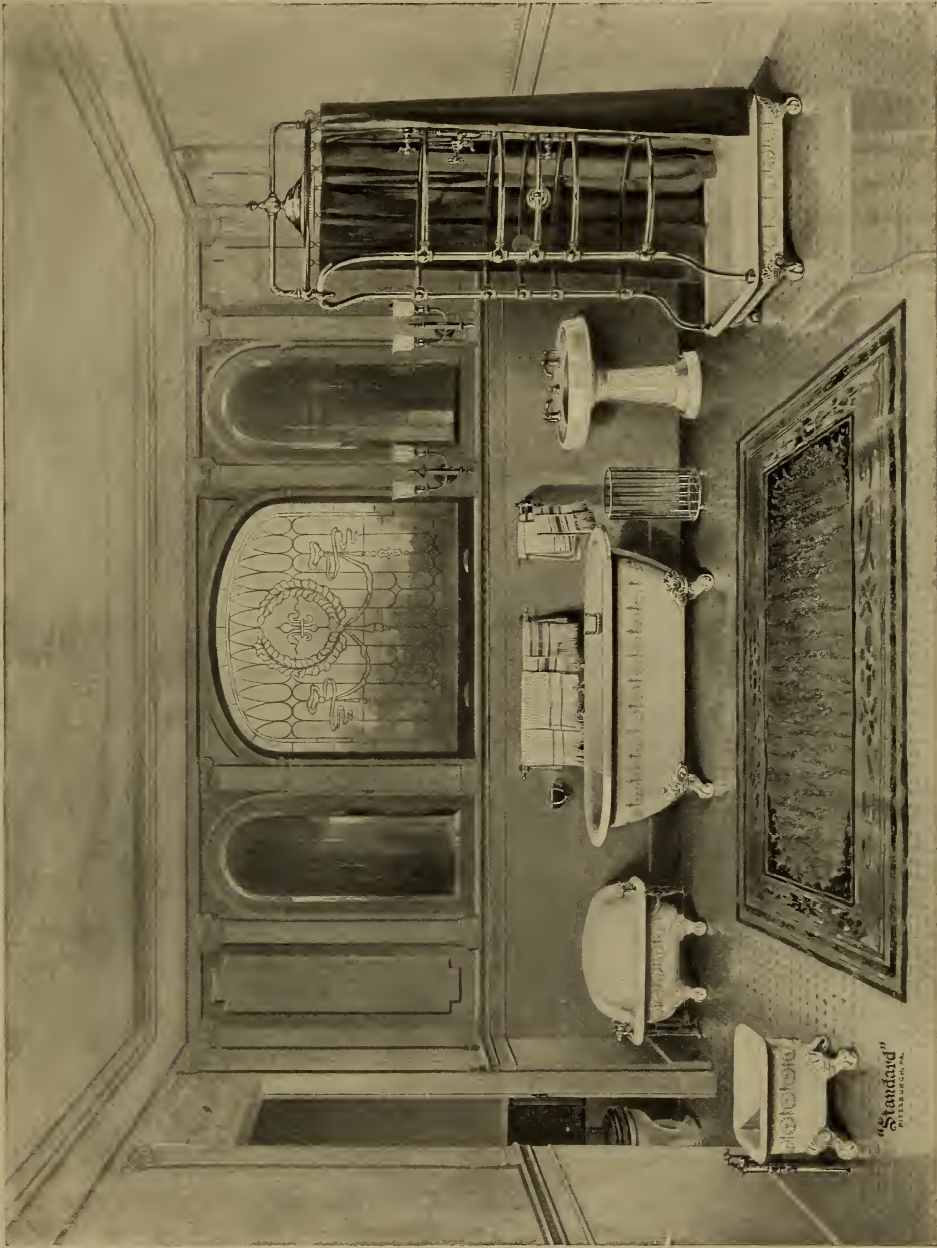

BATHROOM DESIGN—A. Description and Approximate Prices on Opposite Page.



In Orders and Specifications give Plate Numbers.

BATHROOM DESIGN B.

Illustrated on Next Page.

CLOSET —Holbrook, Merrill & Stetson, 96-C, Elbe Porcelain Enameled inside and outside; Wash Down Siphon Bowl with Oak Seat and Cover, Oak Zink-lined Tank and Nickel-Plated Angle Supply with Nickel-Plated Slip Joint Valve.....	\$ 26.60
BATH —Holbrook, Merrill & Stetson, 5-foot, 644-C, 3-inch Porcelain Enameled Bath, with Nickel-Plated Fuller Double Bath Cock, Supply Pipes and Imperial Waste.....	45.25
For No. 1 Zinc White Exterior Finish and Gold Lines, add.....	\$21.00
SHOWER —Holbrook, Merrill & Stetson, 772-C, Nickel-Plated Portable Shower Bath with Rubber Curtain.....	15.00
FOOT BATH —Holbrook, Merrill & Stetson, 660-C, 3-inch Roll Rim Porcelain Enameled Foot Bath, with Nickel-Plated Bell Supply and Waste Fittings.....	34.00
For No. 1 Zinc White Exterior Finish and Gold Lines, add.....	\$9.50
LAVATORY —Holbrook, Merrill & Stetson, 18 x 27, 1070-C, Porcelain Enameled all over, Lavatory on Brackets with Colonial Pattern Monarch Fuller Basin Cocks with China Handles marked Hot and Cold, Nickel-Plated Supply Pipes, Imperial Waste and Elliptical Trap to Wall	37.00
MISCELLANEOUS TRIMMINGS —Brass Nickel-Plated:	
Mirror, 16 x 24 inches, 955-C.....	14.00
Glass Shelf, 928-C.....	7.50
Wall Soap Dish, 835-C.....	1.50
Towel Bar for Lavatory, 30 inches long, 902-C.....	2.00
Towel Bar for bath, 30 inches long, 901-C.....	1.35
Coat Hook, 933-C.....	.50
Toilet Paper Holder, 949-C.....	1.50
Soap and Sponge Holder, 871-C.....	3.20
Total Approximate Cost.....	\$189.40

BATHROOM INTERIORS.



BATHROOM DESIGN—B. Description and Approximate Prices on Opposite Page.

In Orders and Specifications give Plate Numbers.

HOLBROOK, MERRILL & STETSON.

BATHROOM DESIGN C.

Illustrated on Next Page.

CLOSET—Holbrook, Merrill & Stetson, 96-C, Elbe Porcelain Enameled inside and Painted outside; Wash Down Siphon Bowl with Oak Seat and Cover, Oak Zinc-lined Tank with Nickel-Plated Supply with Slip Joint Valve..... \$ 26.60

BATH—Holbrook, Merrill & Stetson, 5-foot, 639-C, 3-inch Porcelain Enameled Bath with Nickel-Plated Fuller Double Bath Cock, Supply Pipes and Connected Waste and Overflow 40.50
For No. 1 Zinc White Exterior Finish, add.....\$16.00

LAVATORY—Holbrook, Merrill & Stetson, 18 x 24 inches, 1072-C, Porcelain Enameled Exterior Lavatory on Porcelain Enameled Brackets, with Nickel-Plated Low Pattern Compression Faucets with China Indexes, Supply Pipes with Slip Joint Valves, and H., M. & S. Vented Adjustable "P" Trap..... 21.25

NOTE—Lavatory shown in Bathroom Design C, is 1072-C, except that it has Keystone Waste, Low Pattern Compression Basin Cocks instead of Torrance Basin Cocks and Vented "P" Trap instead of Plain "P" Trap.

MISCELLANEOUS TRIMMINGS—Brass Nickel-Plated:

Mirror, 13 x 20 inches, 955-C.....	11.00
Opal Glass Shelf, 20 inches, 926-C.....	4.10
Wall Soap Dish, 828-C.....	1.50
Towel Hooks, 932-C.....	2.25
Towel Bar, 30 inches long, 902-C.....	2.00
Coat Hook, 933-C.....	.50
Toilet Paper Holder, 945-C.....	.40
Bath Tub Soap Dish, 843-C.....	1.60
Total Approximate Cost.....	<u>\$111.70</u>

In Orders and Specifications give Plate Numbers.

BATHROOM INTERIORS.



BATHROOM DESIGN—C. Description and Approximate Prices on Opposite Page.



In Orders and Specifications give Plate Numbers.

BATHROOM DESIGN D.

Illustrated on Next Page.

CLOSET—Holbrook, Merrill & Stetson, 76-C, Volga Plain Wash Down Siphon Vitreous China Bowl with Oak Seat and Cover and Oak Tank with Nickel-Plated Supply Pipe \$ 22.50

NOTE—Closet as shown in Bathroom Design D, is 76-C, except that it has Plain Supply to floor instead of Angle Supply with Valve.

BATH—Holbrook, Merrill & Stetson 5½-foot, 653-C, 3-inch Roll Rim Porcelain Enameled Menlo Bath, with Nickel-Plated Fuller Double Bath Cock, Offset Supply Pipes and Connected Waste and Overflow..... 39.00
 For No. 1 Zinc White Exterior finish, add.....\$16.00

LAVATORY—Holbrook, Merrill & Stetson, 1083-C, Porcelain Enameled Exterior Lavatory, with Nickel-Plated Keystone Waste and Soap Dish; Low Pattern Compression Basin Cocks; Supply Pipes to wall and “P” Trap..... 21.00
 For Lavatory Enameled all over, add\$2.00

NOTE—Lavatory as shown in Bathroom Design D, is 1083-C, except that it has Low Pattern Compression Basin Cocks with Supplies to wall instead of No. 0 Fuller Basin Cocks with Supplies to floor.

MISCELLANEOUS TRIMMINGS—Brass, Nickel-Plated :

Mirror, 2-16x24 inches, 954-C 28.00
 Opal Glass Shelf, 20 inches long, 926-C..... 4.10
 Opal Glass Towel Bar, 18 inches long, 916-C..... 2.50
 Coat Hook, 933-C..... .50
 Bath Tub Soap Dish, 842-C 1.00
 Toilet Paper Holder, 945-C..... .40

Total Approximate Cost..... \$119.00

BATHROOM INTERIORS.



BATHROOM DESIGN—D.

Description and Approximate Prices on Opposite Page.

In Orders and Specifications give Plate Numbers.

BATHROOM DESIGN E.

Illustrated on Next Page.

CLOSET—Holbrook, Merrill & Stetson, 98-C, Porcelain Enameled inside and outside; Wash-out Bowl with Oak Seat and Cover, and Oak Tank and Tank Board with Nickel-Plated Flush Pipe, Supply Pipe and Chain and Pull..... \$ 20.00

NOTE—Closet as shown in Bathroom Design E, is 98-C, except that it has Supply Pipe to floor instead of Angle Supply Pipe with Valve.

BATH—Holbrook, Merrill & Stetson, 5-foot, 637-C, 1¾-inch Roll Rim Porcelain Enameled Bath Tub, with Nickel-Plated Fuller Double Bath Cock, Supply Pipes and Connected Waste and Overflow..... 38.50
 For No. 1 Zinc White Exterior Finish, add.....\$16.00

LAVATORY—Holbrook, Merrill & Stetson, 20 x 24 inches, 1098-C, Porcelain Enameled Inside Lavatory with Concealed Wall Hanger, Nickel-Plated No. 0 Monarch Fuller Basin Cocks, Plain Supply Pipes to wall and Vented "P" Trap..... 20.75

NOTE—Lavatory shown in Bathroom Design E, is 1098-C, except that it has Wall Hanger, Plain Supply Pipes and Vented Trap, instead of Brackets, Supply Pipes with Valves and Plain "P" Trap.

MISCELLANEOUS TRIMMINGS—Brass Nickel-Plated:

Mirror, 18 x 30 inches, 954-C.....	16.00
Glass Combination Shelf, 928-C.....	7.50
Towel Bar, 24 inches long, 900-C.....	.85
Coat Hook, 933-C.....	.50
Toilet Paper Holder, 948-C.....	.50
Bath Tub Soap Holder, 841-C.....	.65
Total Approximate Cost.....	<u>\$105.25</u>

BATHROOM INTERIORS.

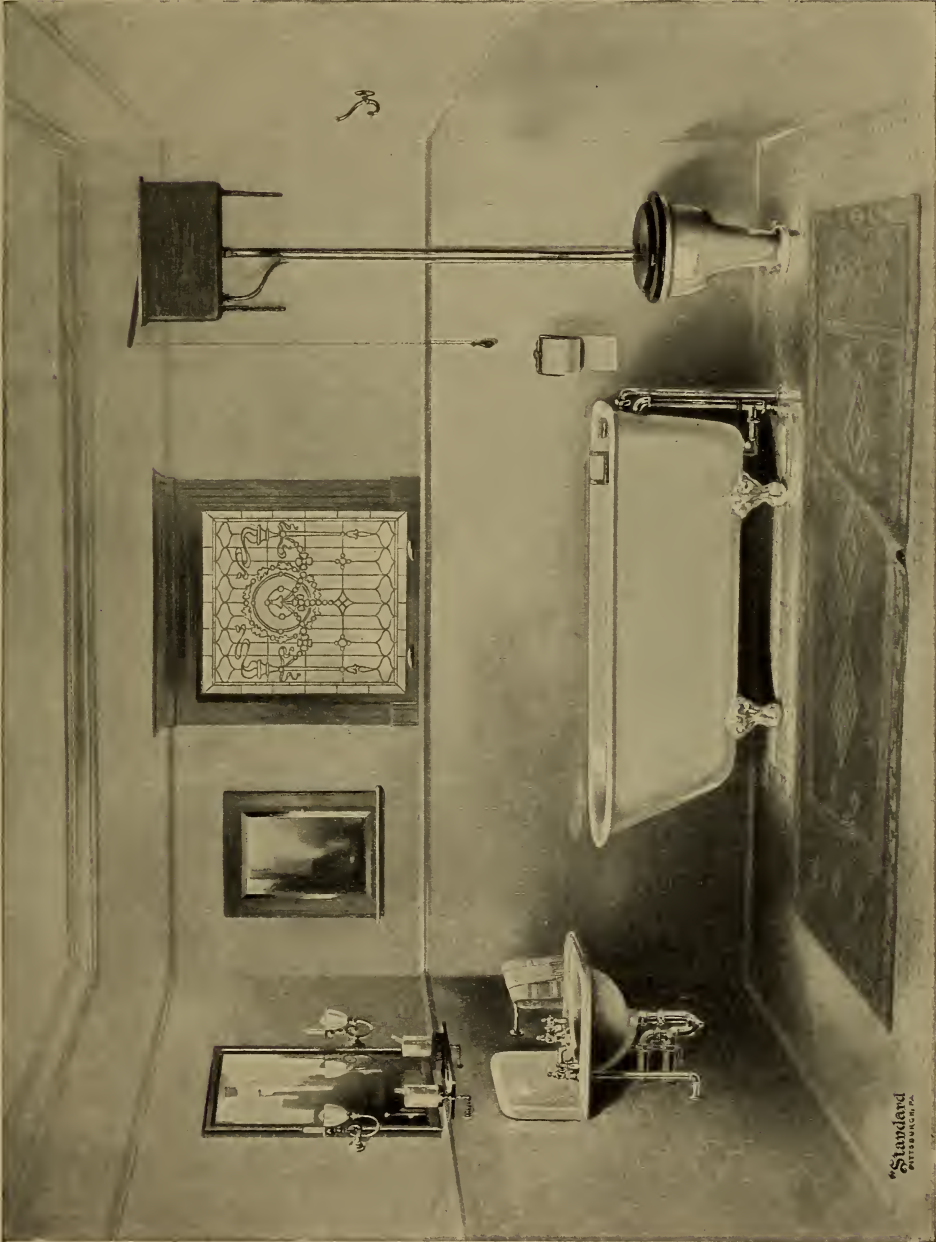

BATHROOM DESIGN—E. Description and Approximate Prices on Opposite Page.



In Orders and Specifications give Plate Numbers.

HOLBROOK, MERRILL & STETSON.

BATHROOM DESIGN F.

Illustrated on Next Page.

CLOSET—Holbrook, Merrill & Stetson, 72-C, Eddy Plain Siphon Pinnacle Jet Vitreous China Bowl, with Oak Seat and Cover and Oak Tank with Marble Top and Nickel-Plated Supply Pipe to floor with Stop..... \$ 30.50

NOTE—Closet shown in Bathroom Design F is 72-C except that it has Marble Top Tank and Supply Pipe with Stop instead of Wood Top Tank and Supply without Stop.

BATH—Holbrook, Merrill & Stetson, 5-foot, 632-C, 3-inch Roll Rim Porcelain Enameled Bath with Exterior finished in No. 1 Zinc White, 5-inch extension at Fitting End, with Nickel-Plated Imperial Supply and Waste Fittings..... 83.00

SHOWER—Holbrook, Merrill & Stetson, 765-C, Nickel-Plated Shower Bath, with Curtain Ring and Rubber Curtain and Shampoo Attachment..... 42.50

NOTE—Shower shown in Bathroom Design F is 765-C except that it has Curtain Ring and Curtain.

SITZ BATH—Holbrook, Merrill & Stetson, 657-C, 3-inch Roll Rim, Porcelain Enameled Sitz Bath, with Exterior finished in No. 1 Zinc White, with Nickel-Plated Imperial Bell Supply and Waste Fittings..... 57.50

LAVATORY—Holbrook, Merrill & Stetson, 18x27 inches, 1070-C, Porcelain Enameled all over Lavatory on Nickel-Plated Legs and Frame, with Torrance Pattern Fuller Basin Cocks with China Handles and Indexes. Plain Supply Pipes to wall; Imperial Waste and Elliptical "P" Trap..... 45.50

NOTE—Lavatory shown in Bathroom Design F is 1070-C except that it has Plain Supply Pipes instead of Supply Pipes with Valves.

MISCELLANEOUS FITTINGS—Brass, Nickel-Plated :

Mirror, 21x30 inches, 955-C.....	23.00
Glass Towel Shelf and Bar, 24 inches long, 924-C.....	12.00
Class Towel Bar, 24 inches long, 918-C.....	4.00
Coat Hook, 933-C.....	.50
Brush Tray, 884-C.....	2.25
Tooth Brush Holder, 866-C.....	1.25
Wall Soap Dish, 836-C.....	2.00
Towel Basket, 889-C.....	11.00
Combination Soap and Sponge Holder, 871-C.....	3.20
Toilet Paper Holder, 949-C.....	1.50

Total Approximate Cost \$319.70

In Orders and Specifications give Plate Numbers.

BATHROOM INTERIORS.



BATHROOM DESIGN—F. Description and Approximate Prices on Opposite Page.



In Orders and Specifications give Plate Numbers.

BATHROOM DESIGN G.

Illustrated on Next Page.

CLOSET—Holbrook, Merrill & Stetson, 96-C, Elbe Porcelain Enameled inside and outside; Wash Down Siphon Bowl, with Oak Seat and Cover, Oak Zinc-lined Tank and Nickel-Plated Angle Supply with Nickel-Plated Slip Joint Valve \$ 23.60

BATH—Holbrook, Merrill & Stetson, 5-foot, 632-C, 3-inch Porcelain Enameled Bath with Nickel-Plated Bell Supply and Waste Fittings..... 67.00
 For No. 1 Zinc White Exterior Finish, add.....\$16.00

SHOWER—Holbrook, Merrill & Stetson, 765-C, Nickel-Plated Shower Bath, with Curtain Ring and Rubber Curtain and Shampoo Attachment..... 42.50

NOTE—Shower shown in Bathroom Design G, is 765-C, except that it has Curtain Ring and Curtain.

SITZ BATH—Holbrook, Merrill & Stetson, 659-C, 3-inch Roll Rim Porcelain Enameled Sitz Bath, with Nickel-Plated Bell Supply and Waste Fittings..... 55.00
 For No. 1 Zinc White Exterior Finish, add.....\$10.50

LAVATORY—Holbrook, Merrill & Stetson, 18 x 27 inches, 1070-C, Porcelain Enameled all over Lavatory on Nickel-Plated Legs and Frame, with Nickel-Plated Colonial Pattern Monarch Fuller Basin Cocks with China Handles marked Hot and Cold, Supply Pipes with Slip Joint Valves, Imperial Waste and Elliptical Trap to Wall.... 45.50

MISCELLANEOUS TRIMMINGS—Brass Nickel-Plated:

Mirror, 18 x 30 inches, 954-C..... 16.00
 Glass Shelf, 24 inches long, 922-C..... 4.50
 Towel Bar, 20 inches long, 894-C..... 1.75
 Towel Basket, 889-C... .. 11.00
 Coat Hook, 933-C..... .50
 Toilet Paper Holder, 945-C..... .40
 Soap and Sponge Holder, 871-C..... 3.20

Total Approximate Cost..... \$273.95

In Orders and Specifications give Plate Numbers.

BATHROOM INTERIORS.

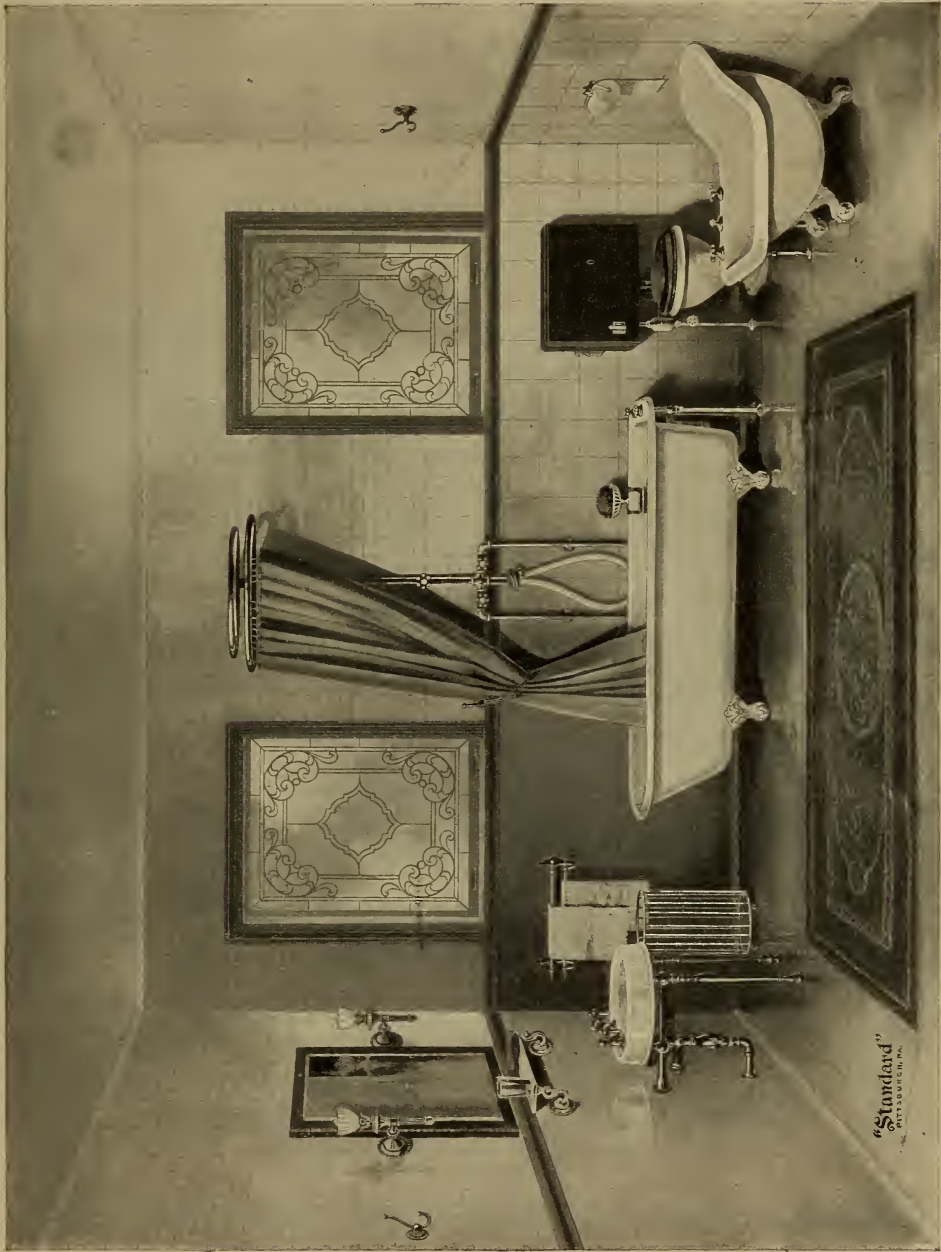

BATHROOM DESIGN—6. Description and Approximate Prices on Opposite Page.



In Orders and Specifications give Plate Numbers.

Our Showrooms

We have just completed, at great expense, commodious showrooms, which the plumbing trade and its patrons, and the architects are cordially invited to freely use when seeking the latest and best to be secured in sanitary plumbing equipment.

In these rooms we endeavor to display fixtures set up complete in every detail, and those that require practical demonstrations, such as closets, showers, etc., are connected with city water supply.

Besides showing separate complete fixtures we have arranged entire bathrooms, from the most elaborate to those of moderate cost, in which are displayed every possible requirement in their connection for a modern, well appointed home.

SECTION 1.

WATER CLOSETS.

WATER CLOSET BOWLS.

WATER CLOSET SEATS AND TANKS.

WATER CLOSET SUNDRIES, ETC.



HOLBROOK, MERRILL & STETSON,

INCORPORATED.

SAN FRANCISCO, LOS ANGELES AND NEW YORK.

WATER CLOSETS.

In all of our Closet Combinations, except one or two which are classed as competition goods, the bowls are made of **vitreous china**. They are the best that can be had and are equal to Mott's "Vitro-Adamant," Clow's "Adamantose" and Wolff's "Duroware."

Being built on scientific lines, their operation is perfect.

The tanks in our high tank Closet Combinations are fitted with practically **noiseless ball cocks** of a very high grade. Suitable for High or Low Pressure.

The tanks in our low tank Closet Combinations are fitted with the **high pattern cocks** suitable for any pressure.

In ordering goods from this section by telegraph, it is only necessary to use the code word over or opposite the name, number or size of the article wanted, preceded by words from telegraphic code in front of this book.

Example: Crosistas one Packhoe.

Translation: Ship by railroad immediately one Boston Siphon Jet Closet Combination.

THE KENNEY FLUSHOMETER.

The most Practical, Economical and Silent Method of Flushing Water Closets.

A Sanitary Device which is a great advance over any system yet offered.

A perfectly satisfactory and reliable flushing arrangement can only be secured by having a solid column of water directly at the Bowl. This arrangement overcomes entirely the imperfections which attend the use of a disconnected stream of water released from an overhead tank as in the case of numerous types of closet apparatus now in use.

The Flushometer is designed for use on either direct pressure or tank systems; working with ease and efficiency under any pressure, giving a rapid flush of large volume at the start and finishing with a slow after-flush of small volume for refilling the bowl.

In this system the overhead flush tank may be entirely dispensed with, and as these tanks are a necessary feature of nearly all closets now on the market, it is highly suitable for dwellings or other buildings in which there are closets on each floor, while a single supply tank is located in the attic or on the roof, each closet being connected to the main pipe by a branch connection.

To all intents and purposes, the Flushometer is a well-constructed water meter and so sensitive that by easy adjustment it can be made to measure the supply to the bowl and yield the same quantity at every operation.

This feature makes it possible to calculate accurately the volume of water according to requirements and to increase or diminish same as desired. The valve is made without springs or cup leathers, closes by gravity against the pressure and works perfectly either under low or high pressure, even up to three hundred pounds.

The Flushometer system is the only one that will operate under every condition. No matter how many closets are being used at the same time, it will positively give to each any number of thorough flushes.

Where it is used the cost of installation and maintenance is reduced, and the sanitary conditions are greatly improved, as it permits the construction of Lavatories of the airiest, lightest and most healthful description.

It is noiseless, doing away with the disagreeable rushing and hissing of water, and, if desired, can be made to open and close automatically.

It permits building of windows in space that would otherwise be occupied by flush tanks, and enables the architect to arrange his plans more conveniently than any other system, as the closets can be placed anywhere, under stairways, etc.

No pipes need be shown, there is no pull and chain and no ball-cock to get out of order.

The Closets will work under any pressure, they are ornamental in design, and the system is the most durable one now made.

HOW TO INSTALL THE FLUSHOMETER.

For Direct Pressure.

The Flushometer No. 12 can be connected direct to the water supply without the use of any tank, column or chamber. In such cases the size of the water supply pipe from the building line to the Flushometer should be from $1\frac{1}{4}$ to $1\frac{1}{2}$ inches, according to distance and pressure. The service pipe from the street main to the building line should be not less than 1 inch, and if the pressure is less than 25 pounds, should be $1\frac{1}{2}$ inches. The pressure at the highest Flushometer must be at least 10 pounds. If the service pipe is $1\frac{1}{2}$ inches there should be two taps $\frac{3}{8}$ -inch each on the street main.

Four closets can be operated on a service such as above described. Where a greater number of closets are to be installed the size of the supply pipe should be increased. See 28-C, page 21.

For Tank Pressure.

Place tank where convenient, but about six feet above the highest closet, and run pipe down to the various floors where the closets are to be located. A $1\frac{1}{2}$ -inch pipe is sufficient for from one to four closets. If there are more closets, run a 2-inch pipe down about 10 feet from the tank and $1\frac{1}{2}$ -inch pipe for the remainder. In all cases take out branches for the valve chamber, as specified on page 6.

If the building is quite high, say 10 stories or over, the two lower floors may be reduced to 1-inch.

Where the tank is **less** than 12 feet above the closet, use the Low Pressure Flushometer, $1\frac{1}{2}$ -inch inlet.

Where the tank is from 12 to 20 feet above the closet, use the High Pressure Flushometer, $1\frac{1}{4}$ -inch inlet.

Tank Capacity:—Where possible, the tank should have a capacity of six gallons to the closet. In large installations rigid adherence to this rule is not necessary, as six gallons to the closet provides for two flushes, one immediately following the other, of each and every closet. As it is highly improbable that all closets would be used simultaneously, the rule can be modified to suit each individual case and probable call on the service.

Adjust the regulating ring to suit pressure.

METHOD OF ADJUSTMENT.

See cuts, page 7.

The Handle "U" is pulled gently upward, forcing the Piston "O" and the Relief Valve "N" to the top of Valve Cylinder "C."

On releasing the Handle, the Piston and Relief Valve gradually settle of their own weight to the Valve Seat.

While settling the Piston "O," fitting closely to the Cylinder "C," creates a vacuum in the upper part of Cylinder and remains suspended until air is admitted through regulating screw "P."

To regulate the quantity of air admitted and so shorten or lengthen the time of flush, the Regulating Screw "P" is unscrewed or screwed up.

The volume of water entering at ports is controlled by the Regulating Ring "F," which is timed to open or close the ports as required by the varying heads of water.

METHOD OF OPERATION.

Pull the Handle gently upward for one second, let go, and it will close of its own accord, slowly, against a high or low pressure.

The Flushometer should take from six to nine seconds to flush properly, as may be desired.

There are only two leather washers, one on the seat of the relief valve and the other on the seat of the main valve, which valve can be unscrewed and new washers put on when necessary. To do this, first unscrew the Cap, then the Valve Cylinder, then the Relief Valve, which can be done without disconnecting any piping.

As the Flushometer has no springs or cup-leathers, works automatically by gravity and is cushioned by the action of the water, the chance for wear or getting out of order is practically eliminated.

Be careful and see that white or red lead, used in making joints, does not get into the cylinder of the Flushometer. If this should occur, clean the inside of the Valve Cylinder, also Main Valve to prevent adhesion or obstruction.

FLUSHOMETERS.

Following are styles of Flushometer valves made to meet various conditions as to pressure, etc.

Where the **Nos. 11** and **12** valves are used in connection with a Gate or Angle Valve, they are provided with male threads. If used without these extra valves, they have female threads.

No. 11—Low pressure. For use where pressure is under 6 pounds, or where tank is from 6 to 12 feet above closet. Inlet $1\frac{1}{2}$ inches.

No. 12—High pressure. For use where pressure is 6 to 15 pounds, or where tank is from 12 to 30 feet above the closet. Inlet $1\frac{1}{4}$ inches.

No. 12½—High pressure. For use where pressure is from 15 to 20 pounds or more, or where tank is from 30 to 100 feet or more above the closet. Inlet 1 inch.

No. 14—Low pressure. For marine and salt water use. Inlet $1\frac{1}{2}$ inches.

No. 4½—High pressure. For marine and salt water use. Inlet $1\frac{1}{2}$ inches.

No. 5—Low pressure. This Flushometer combination is used only in connection with an overhead tank. The overflow is concealed in the flush pipe and discharges through the closet.

No. 16—Low pressure. For use on urinals. Is smaller than the Flushometer used for water closet service. Inlet 1 inch.

No. 16½—High pressure. For use on urinals. Inlet $\frac{3}{4}$ inch.

No. 17—Low pressure. For use where it is desirable to conceal Flushometer, as shown on pages 13, 14 and 15. Inlet $1\frac{1}{2}$ inches.

No. 17½—High pressure. For same use as **No. 17**. Inlet $1\frac{1}{4}$ inches.

No. 18—Low pressure. For use in asylums, public institutions, as shown on page 15. Inlet $1\frac{1}{2}$ inches.

No. 18½—High pressure. For same use as **No. 18**. Inlet $1\frac{1}{4}$ inches.

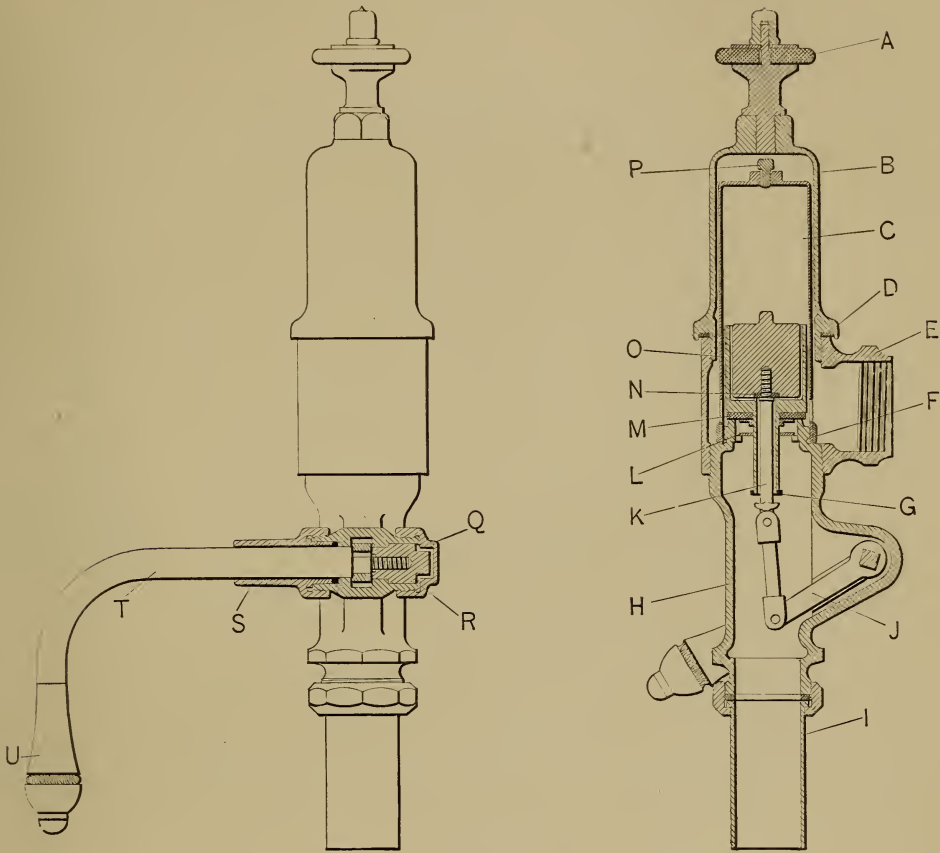

1-C.

The above cuts show working parts of the Flushometer-Valve.

- | | | |
|-------------------|----------------------|------------------------|
| A—Rubber Bumper. | H—Valve Body. | O—Main Valve Piston. |
| B—Cap. | I—Slip Tail Piece. | P—Regulating Screw. |
| C—Valve Cylinder. | J—Link. | Q—Cap of Handle Bar. |
| D—Fibre Washer. | K—Relief Valve Stem. | R—Handle Bar Nut. |
| E—Inlet Tee. | L—Controller. | S—Stuffing Box. |
| F—Inlet Ring. | M—Main Valve Washer. | T—Handle Bar or Lever. |
| G—Controller Nut. | N—Relief Valve. | U—Porcelain Tip. |

The pressure of water at height of 25 feet is 10.82 pounds per square inch.

Price on Parts of Flushometers.

Code.	Name.	Each.	Code.	Name.	Each.
Pabello.....	Rubber Bumper.....	\$0.30	Pacatian.....	Controller.....	\$0.10
Pabillor.....	Cap.....	3.80	Pacative.....	Main Valve Washer.....
Pabillum.....	Valve Cylinder.....	3.00	Pacato.....	Relief Valve.....	1.00
Pabilone.....	Fibre Washer.....	Pacaviss.....	Main Valve Piston.....	2.00
Pabonibo.....	Inlet Tee.....	3.00	Pachian.....	Regulating Screw.....	.10
Pabulari.....	Regulating Ring.....	.50	Pacciott.....	Cap of Handle Bar.....
Pabulose.....	Controller Nut.....	.10	Paccius.....	Handle Bar Nut.....
Pacageon.....	Valve Body.....	6.00	Pacedera.....	Stuffing Box.....	.60
Pacandor.....	Slip Tail Piece.....	1.30	Pacense.....	Handle Bar or Lever.....	2.00
Pacancier.....	Link.....	.80	Paceremin.....	Porcelain Tip.....	.30
Pacateza.....	Relief Valve Stem.....			

In ordering parts of Flushometer always give the number of Flushometer for which they are wanted.

FLUSHOMETER GATE VALVE.

BRASS, NICKEL-PLATED.

Both ends standard iron pipe thread.

Code.....	Pachadill	Pachalik	Pachaman
Inches.....	1	1¼	1½
Measure, face to face, inches.....	2½ ₁₆	2½	2½
Each.....	\$3.00	3.50	4.50
Weight, each, lbs.....	1½	2½	3½

These valves are finished with nickel-plated cap to screw on end of spindle in place of handle.

End of spindle has square shank with threaded corners, and valve can be easily opened with a pair of pliers after removing cap.



3-C.

†FLUSHOMETER ANGLE VALVE.

BRASS, NICKEL-PLATED.

Union valve with standard iron pipe threads. Union nipple has male thread.

Code.....	Pacharil	Pachinus
Inches.....	1¼	1½
Measure, center to end of nipple, inches.....
Each.....	\$3.50	4.50
Weight, each, lbs.....	3¾	4¾

These valves are finished with nickel-plated cap to screw on end of spindle in place of handle.

End of spindle has square shank with threaded corners, and valve can be easily opened with a pair of pliers after removing cap.

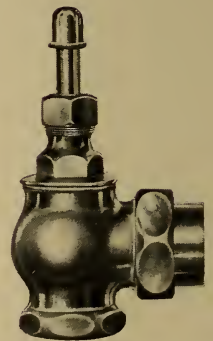

4-C.

†Carried in San Francisco only.

“ROSALIA” SIPHON JET CLOSET.

WITH KENNEY'S PATENT FLUSHOMETER.



5-C.

“Rosalia” Embossed Siphon Jet Vitreous China Bowl, with Nickel-Plated Brass Flushometer; 1½-inch Quartered Oak Seat and Cover, cabinet finish, with Special Nickel-Plated Offset Hinge; Brass Floor Flange, and Nickel-Plated Screws and Washers. Marble Floor Slabs extra.

No. 11 Flushometer, for pressures under 6 pounds, or where tank is from 6 to 12 feet above closet.

No. 12 Flushometer, for pressures 6 to 15 pounds, or where tank is from 12 to 30 feet above closet.

No. 12½ Flushometer, for pressures 15 to 50 pounds, or where tank is from 30 to 100 feet above closet.

Code.....	Pachismo	Pachole	Pachoque
Style	5-C No. 11 Flushometer	5-C No. 12 Flushometer	5-C No. 12½ Flushometer
Price as described.....	\$39.00	39.00	39.00
Shipping weight, lbs.....	80	80	80
Shipping measurement, cubic feet...	5½	5½	5½

If with Nickel-Plated Brass Gate Valve, add \$4.50.

Roughing-in Measurements :

Distance from face of finished wall to center of outlet for back connection, 13½ inches; for side connection, 12 inches; distance from floor to center of Flushometer inlet, 25 inches.

If Gate Valve is used with back connection, add 2½ inches.

For either tank or direct supply. For use in batteries or single installations. Supply should be 1½ inches for No. 11, 1¼ inches for No. 12, and 1 inch for No. 12½ Flushometer.

In Orders and Specifications give Plate Numbers and Number of Valve.

“LATONA” SIPHON JET CLOSET.

WITH KENNEY'S PATENT FLUSHOMETER.



7-C.

“Latona” Plain Siphon Jet Vitreous China Bowl, with Nickel-Plated Brass Flushometer; 1½-inch Quartered Oak Seat and Cover, cabinet finish, with Special Nickel-Plated Offset Hinge; Brass Floor Flange, Nickel-Plated Screws and Washers. Marble Floor Slabs extra.

No. 11 Flushometer, for pressures under 6 pounds, or where tank is from 6 to 12 feet above closet.

No. 12 Flushometer, for pressures 6 to 15 pounds, or where tank is from 12 to 30 feet above closet.

No. 12½ Flushometer, for pressures 15 to 50 pounds, or where tank is from 30 to 100 feet above closet.

Code	Pachorra	Pachten	Pachtut
Style.....	7-C No. 11 Flushometer	7-C No. 12 Flushometer	7-C No. 12½ Flushometer
Price as described.....	\$38.00	38.00	38.00
Shipping weight, lbs.....	78	78	78
Shipping measurement, cubic feet.....	5½	5½	5½

If with Nickel-Plated Brass Gate Valve, add \$4.50.

Roughing-in Measurements:

Distance from face of finished wall to center of outlet for back connection, 13½ inches; for side connection, 12 inches; distance from floor to center of Flushometer inlet, 25 inches.

If Gate Valve is used with back connection, add 2½ inches.

For either tank or direct supply. For use in batteries or single installations. Supply should be 1½ inches for No. 11, 1¼ inches for No. 12, and 1 inch for No. 12½ Flushometer.

In Orders and Specifications give Plate Numbers and Number of Valve.

“TIBER” WASH DOWN SIPHON CLOSET.

WITH KENNEY'S PATENT FLUSHOMETER.



9-C.

Plain Wash Down Vitreous China Bowl, with 1½-inch Nickel-Plated Adjustable Elbow, for back connection and Nickel-Plated Brass Flushometer; Nickel-Plated Brass Gate Valve; 1½-inch Quartered Oak Seat and Cover, cabinet finish, with Special Nickel-Plated Offset Hinges; Brass Floor Flange, Nickel-Plated Screws and Washers.

No. 11 Flushometer, for pressures under 6 pounds, or where tank is from 6 to 12 feet above closet.
 No. 12 Flushometer, for pressures 6 to 15 pounds, or where tank is from 12 to 30 feet above closet.
 No. 12½ Flushometer for pressures 15 to 50 pounds, or where tank is from 30 to 100 feet above closet.

Code.....	Pachtgeb	Pachtgeld	Pachtgutt
Style	9-C No. 11 Flushometer	9-C No. 12 Flushometer	9-C No. 12½ Flushometer
Price as described.....	\$39.00	39.00	39.00
Shipping weight, lbs.....	80	79	79
Shipping measurement, cubic feet....	5½	5½	5½

If without Gate Valve, deduct \$1.50

Roughing-in Measurements:

Distance from face of finished wall to center of outlet for back connection, 15½ inches; for side connection, 14 inches; distance from floor to center of Flushometer inlet, 25 inches.
 If Gate Valve is used with back connection as shown above, add 2½ inches.
 For either tank or direct supply. For use in batteries or single installations. Supply should be 1½ inches for No. 11, 1¼ inches for No. 12, and 1 inch for No. 12½ Flushometer.

In Orders and Specifications give Plate Numbers and Number of Valve.

“JUMBO” SIPHON JET CLOSET.

WITH KENNEY'S PATENT FLUSHOMETER. FOR PUBLIC BUILDINGS, ETC.



11-C.

“Jumbo” Extra Large Plain Siphon Jet Vitreous China Bowl, with Concealed Jet Arm and 3 1/2-inch Siphon Limb, Nickel-Plated Brass Flushometer; Nickel-Plated Brass Gate Valve; 1 1/2-inch Quartered Oak Saddle Seat, cabinet finish, with Special Nickel-Plated Socket Hinge; Nickel-Plated Screws and Washers.

No. 11 Flushometer for pressures under 6 pounds or where tank is from 6 to 12 feet above closet.
 No. 12 Flushometer for pressures 6 to 15 pounds or where tank is from 12 to 30 feet above closet.
 No. 12 1/2 Flushometer for pressures 15 to 50 pounds or where tank is from 30 to 100 feet above closet.

Code.....	Pachthaus	Pachtherr	Pachtheur
Style.....	11-C No. 11 Flushometer	11-C No. 12 Flushometer	11-C No. 12 1/2 Flushometer
Price as described.....	\$.....
Shipping weight, lbs.....	124	123	123
Shipping measurement, cubic feet	6 1/2	6 1/2	6 1/2

If without Gate Valve, deduct \$4.50.

Roughing-in Measurements:

Distance from face of finished wall to center of outlet, for back connection, 13 1/2 inches; for side connection, 12 inches; distance from floor to center of Flushometer inlet, 25 inches.
 If Gate Valve is used with back connection, as shown above, add 2 1/2 inches.
 For either tank or direct supply. For use in batteries or single installations. Supply should be 1 1/2 inches for No. 11, 1 1/4 inches for No. 12, and 1 inch for No. 12 1/2 Flushometer.

In Orders and Specifications give Plate Numbers and Number of Valve.

“ROSALIA” SIPHON JET CLOSET.

WITH KENNEY'S PATENT FLUSHOMETER CONCEALED. FOR HOSPITALS, ASYLUMS, BARRACKS,
RAILWAY STATIONS, ETC.



13-C.

“Rosalia” Embossed Siphon Jet Vitreous China Bowl with 1½-inch Nickel-Plated Brass Adjustable Elbow, Nickel-Plated Brass Flushometer; 1½-inch Quartered Oak Seat and Cover, cabinet finish, with Special Nickel-Plated Offset Hinges; Brass Floor Flange and Nickel-Plated Screws and Washers. Marble Floor Slabs extra.

No. 17 Flushometer for pressures under 10 pounds or where tank is from 2 to 20 feet above closet.
No. 17½ Flushometer for pressures over 10 pounds or where tank is more than 20 feet above closet.

Code.....	Pachthofe	Pachtkorn
Style.....	13-C No. 17 Flushometer	13-C No. 17½ Flushometer
Price as described	\$46.50	46.50
Shipping weight, lbs.....	80	80
Shipping measurement, cubic feet.....	5½	5½

If with “Latona” bowl, deduct \$1.00 If with “Tiber” bowl, same price as “Rosalia.”
If with “Jumbo” bowl, add \$.....

For roughing-in measurements and method of installing see page 14. See also sectional cuts, page 20.
For either tank or direct supply. For use in batteries or single installations. Supply should be 1½ inches for No. 17 and 1¼ inches for No. 17½ Flushometer.

In Orders and Specifications give Plate Numbers and Number of Valve.

"ROSALIA" SIPHON JET CLOSET.

WITH KENNEY'S PATENT FLUSHOMETER CONCEALED.

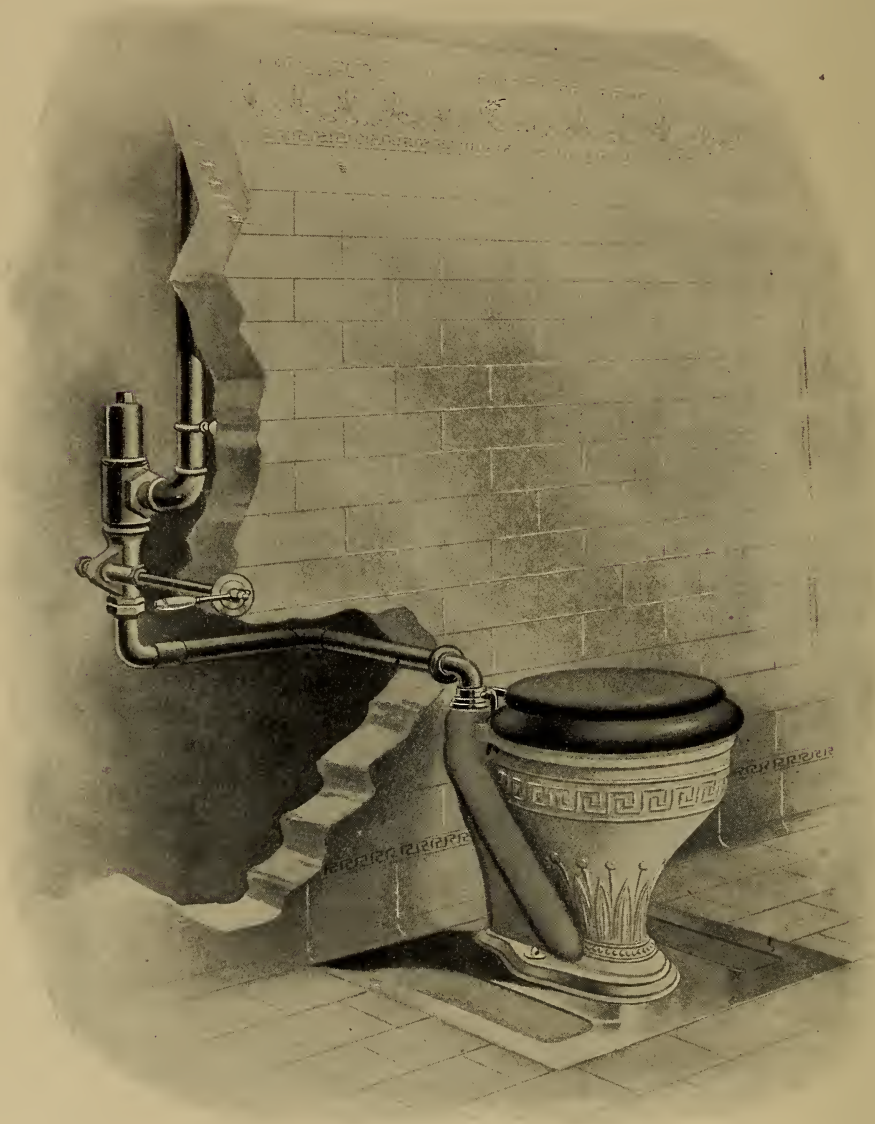
**15-C.**

Section showing method of installation used in cut **13-C**.

See also sectional cuts **25-C**, **26-C** and **27-C**.

Roughing-in measurements for Siphon Jet and Wash Down Bowls installed as shown in cut **15-C**:

"Rosalia"—Distance from face of finished wall to center of outlet, $9\frac{1}{2}$ inches.

"Latona"—Distance from face of finished wall to center of outlet, $9\frac{1}{2}$ inches.

"Tiber"—Distance from face of finished wall to center of outlet, $11\frac{1}{2}$ inches.

"Jumbo"—Distance from face of finished wall to center of outlet, $9\frac{1}{2}$ inches.

Distance from floor to center of Flushometer inlet, $18\frac{1}{2}$ inches for all of above, when installed as shown in cut **15-C**.

“TUMA” WATER CLOSET.

WITH KENNEY'S PATENT FLUSHOMETER. FOR ASYLUMS, HOSPITALS, PRISONS, ETC.



17-C.

“Tuma” Plain Large Area Vitreous Hopper and Trap Combined, solid porcelain seated with Nickel-Plated Brass Flushometer; Brass Flange, for back outlet, and Nickel-Plated Bolts. Can be used with wooden seat if preferred. Marble Floor Slabs extra.

No. 18 Flushometer for pressures under 10 pounds or where tank is from 2 to 20 feet above closet.
 No. 18½ Flushometer for pressures over 10 pounds or where tank is more than 20 feet above closet.

Code.....	Pachtleut	Pachtung
Style.....	17-C No. 18 Flushometer	17-C No. 18½ Flushometer
Price as described.....	\$35.00	35.00
Shipping weight, lbs.....	89	89

For 4-inch Brass Outlet Connection, 7 inches long, add \$7.00.

Roughing-in Measurements:

Distance from floor to center of Flushometer inlet, 14½ inches.
 Distance from floor to center of Bowl outlet, 7½ inches.
 For either tank or direct supply. For use in batteries or single installations. Supply should be 1½ inches for No. 18 and 1¼ inches for No. 18½ Flushometer. Any number of closets can be attached to one tank.

In Orders and Specifications give Plate Numbers and Number of Valve.

“SONOMA” WATER CLOSET.

WITH KENNEY'S PATENT FLUSHOMETER. FOR PUBLIC INSTITUTIONS, ETC.



19-C.

“Sonoma” Plain Large Area Vitreous China Hopper and Trap Combined, with solid porcelain seat, Nickel-Plated Brass Flushometer; Brass Floor Flange and Nickel-Plated Screws. Marble Floor Slabs extra.

No. 11 Flushometer for pressures under 6 pounds, or where tank is from 6 to 12 feet above closet.
 No. 12 Flushometer for pressures 6 to 15 pounds, or where tank is from 12 to 30 feet above closet.
 No. 12½ Flushometer for pressures 15 to 50 pounds, or where tank is from 30 to 100 feet above closet.

Code.....	Pachucha	Pachylope	Pachynol
Style	19-C No. 11 Flushometer	19-C No. 12 Flushometer	19-C No. 12½ Flushometer
Price as described.....	\$35.00	35.00	35.00
Shipping weight, lbs.....	82	82	82

For Nickel-Plated Brass Gate Valve, add \$4.50.
 Wooden seats may be used if preferred.

Roughing-in Measurements:

Distance from face of finished wall to center of outlet, for back connection 17 inches; for side connection, 15½ inches. If Gate Valve is used with back connection, add 2½ inches.
 Distance from floor to center of Flushometer inlet, 25 inches.
 Any number of closets can be attached to one tank. Only one tank in a building.
 For either tank or direct supply. For use in batteries or single installations. Supply should be 1½ inches for No. 11, 1¼ inches for No. 12, and 1 inch for No. 12½ Flushometer.

In Orders and Specifications, give Plate Numbers and Number of Valve.

“ ROSALIA ” SIPHON JET CLOSET.

WITH KENNEY'S PATENT FLUSHOMETER.



21-C.

Single Tank Combination.

Embossed Siphon Jet Vitreous China Bowl with Nickel-Plated Brass Flushometer; 1½-inch Quartered Oak Seat and Cover, cabinet finish, with Special Nickel-Plated Offset Hinges; Quartered Oak Round Cornered Tank, 23x11x10 inches; 2-inch Nickel-Plated Flush Pipe; Brass Floor Flange, and Nickel-Plated Screws and Washers.

Marble Floor Slabs extra.

Code.....	Pachyma
Style.....	21-C No. 5 Flushometer
Price as described.....	\$64.00
Shipping weight, lbs.....	140
Shipping measurement, cu. ft.	9
If with "Latona" Bowl, deduct \$1.00.	

No. 5 Flushometer is used only in connection with our overhead tank.

The overflow is concealed in flush pipe and discharges through the closet.

The water supply to this tank does not differ from the usual tank method.

Roughing-in Measurement:

Distance from face of finished wall to center of outlet, 15 inches.

In Orders and Specifications give Plate Numbers and Number of Valve.

SUGGESTIONS FOR ARCHITECTS.

SPECIFYING KENNEY'S PATENT FLUSHOMETER.

Size Pipe.

TANK PRESSURE.

A one and a half-inch pipe from the Tank to the Closets is sufficient for from one to four closets.

If there are more than four closets, run a 2-inch pipe down to the first lateral, reducing at that point to 1½-inch for the remainder.

In large installations run a 2½-inch pipe to first lateral, then reduce to 2-inch, and 1½-inch for the remainder.

If the building is quite high, say ten stories or over, the two lower floors may be reduced to 1 inch.

The size of lateral pipe varies from 1½-inch to 2½-inch, according to the number of closets in battery on each floor and distance from tank.

In all cases take out 1½ and 1¼-inch branches from the laterals, according to size of valve inlet.

LOW AND HIGH PRESSURE.

Where the tank is *less* than 12 feet above the closet, use No. 11 Low Pressure Flushometer.

Where the tank is from 12 to 30 feet above the closet, use No. 12 High Pressure Flushometer.

Where the tank is over 30 feet above the closet, use No. 12½ High Pressure Flushometer.

If Flushometer closes too slowly, release the regulating screw by unscrewing; if too rapidly, screw it down a little.

TANK CAPACITY.

Where possible the tank should have a capacity of six gallons to the closet. In large installations rigid adherence to this rule is not necessary, as six gallons to the closet provides for two flushes, one immediately following the other of each and every closet. As it is highly improbable that all closets will be used simultaneously, the rule can be modified to suit each individual case.

Specifications should read: "Plate No.—, Holbrook, Merrill & Stetson's Catalogue, No. 115."

SECTIONAL DRAWINGS OF CLOSETS.

WITH KENNEY'S PATENT FLUSHOMETER ATTACHED.

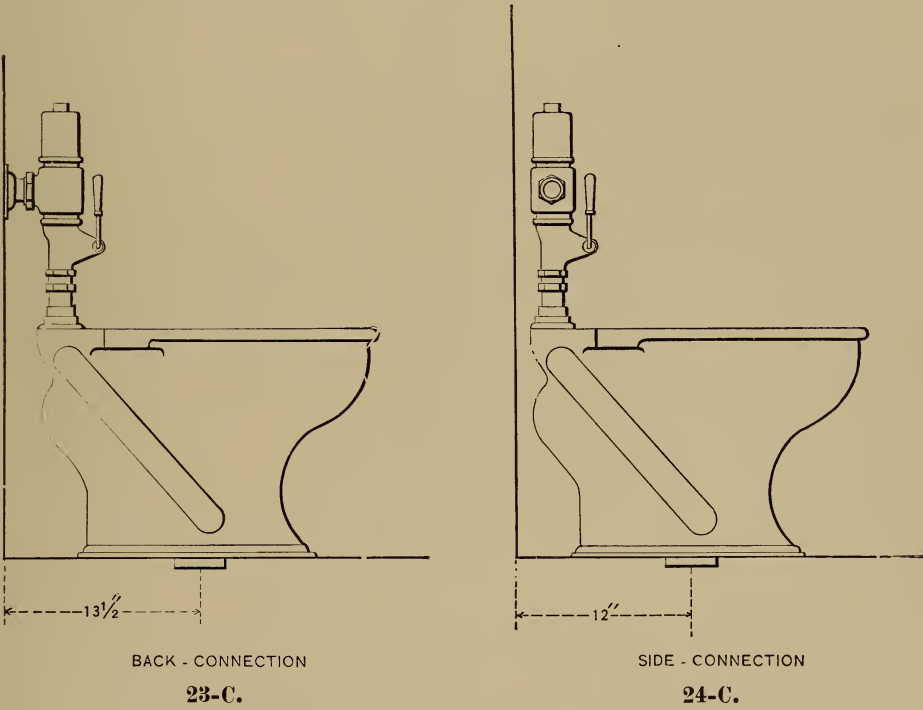

Showing methods of connecting closets illustrating "roughing-in measurements," as given elsewhere in this catalogue.

SECTIONAL VIEW OF PLATES 9-C AND 10-C.

SHOWING METHOD OF INSTALLATION.

See pages 13 and 14.

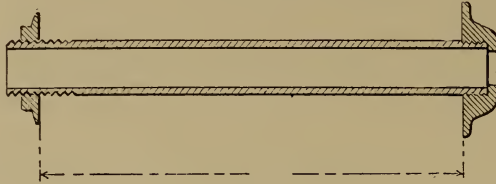

25-C.

Wall nipple shown in cut 27-C.
In ordering give exact length desired, as shown by dotted lines.

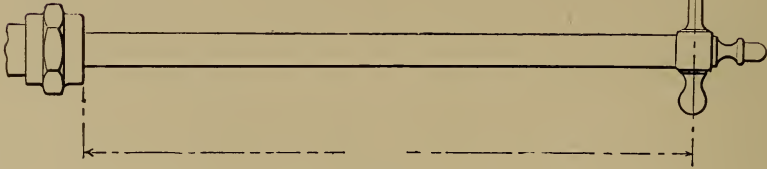

26-C.

Handle Bar shown in cut 27-C. In ordering give length desired, as shown by dotted lines

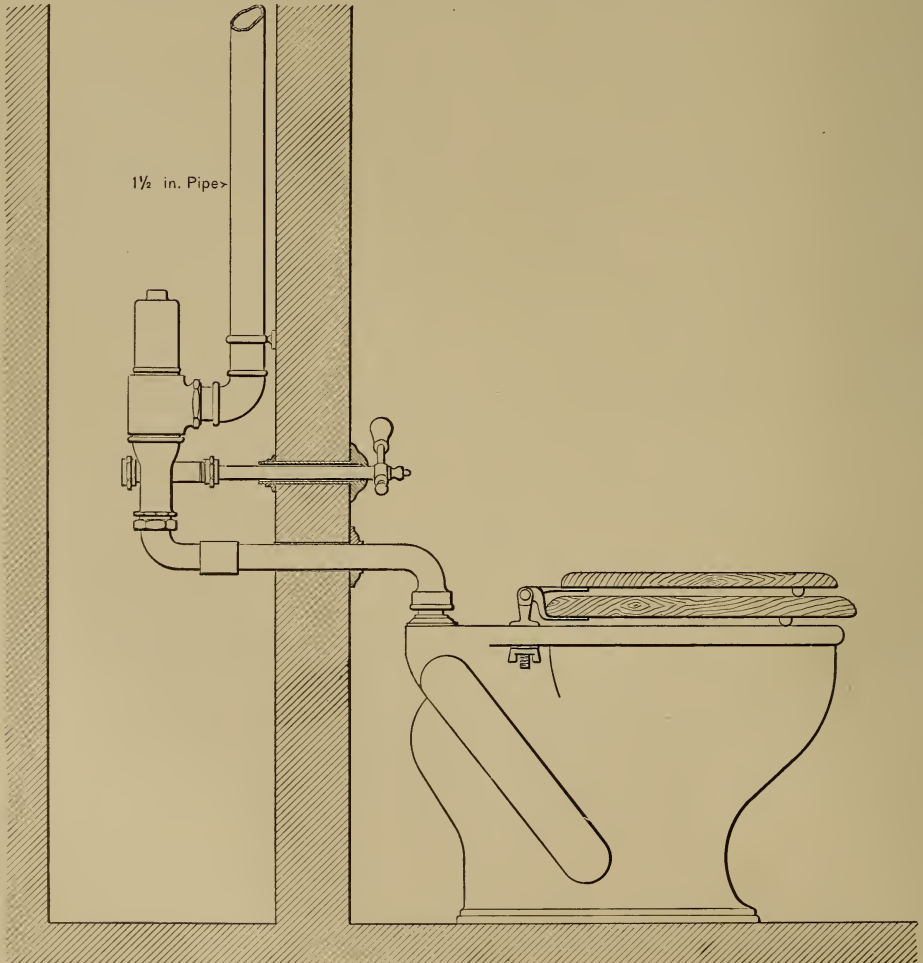

1/2 in. Pipe

27 C.

CONNECTION DIRECT TO STREET MAIN.

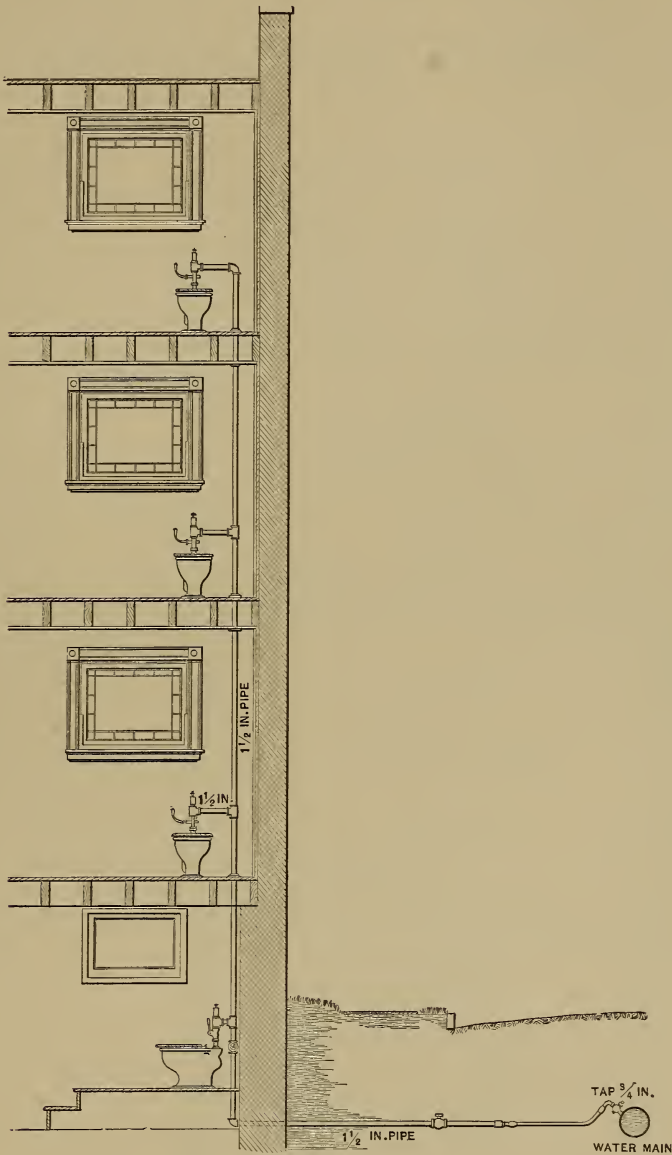

28.C.

The Flushometer No. 12 can be connected to the water supply without the use of a tank as follows:

The water supply should be $1\frac{1}{2}$ inches in diameter from the building line to the Flushometers, The service pipe from the street main to the building line should under no circumstances be less than 1 inch, and if the pressure is less than 25 to 30 pounds it should be $1\frac{1}{2}$ inches.

The street main tap must not be less than $\frac{3}{4}$ inch or its equivalent.

The pressure at the closet highest above the street main must not be less than 10 pounds.

Four closets can be operated on a service such as described above. Where a greater number of closets are to be installed the size of the supply pipe should be increased proportionately.

SECTION OF OFFICE BUILDING.

SHOWING USE OF KENNEY'S PATENT FLUSHOMETER.

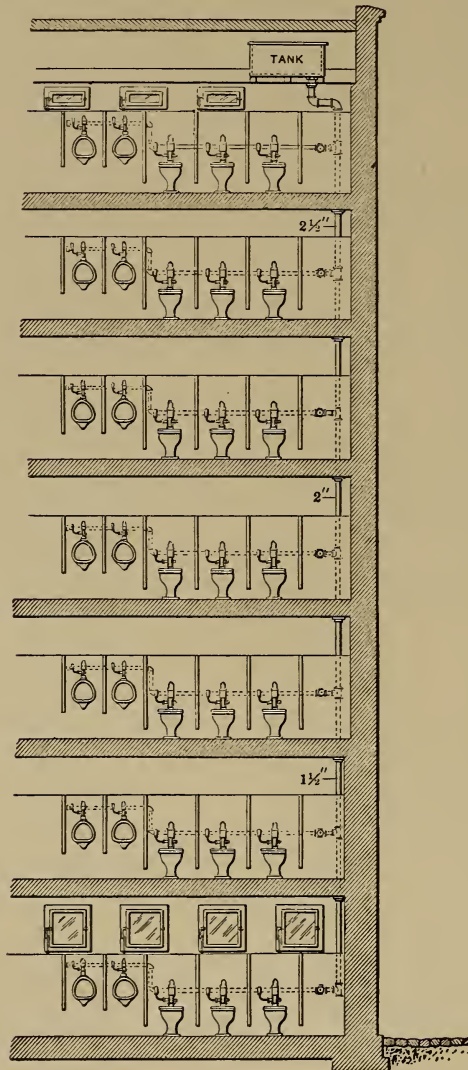

29-C.

This section illustrates a number of batteries of closets arranged on different floors, together with urinals, showing a method of installation frequently used, all being supplied from one tank.

Windows can be inserted as shown in the first and top floors, or in any other desired manner.

Any number of closets or urinals, can be arranged in the batteries.

Laterals can be carried to any point in the building.

SECTION OF RESIDENCE.

SHOWING USE OF KENNEY'S PATENT FLUSHOMETER.

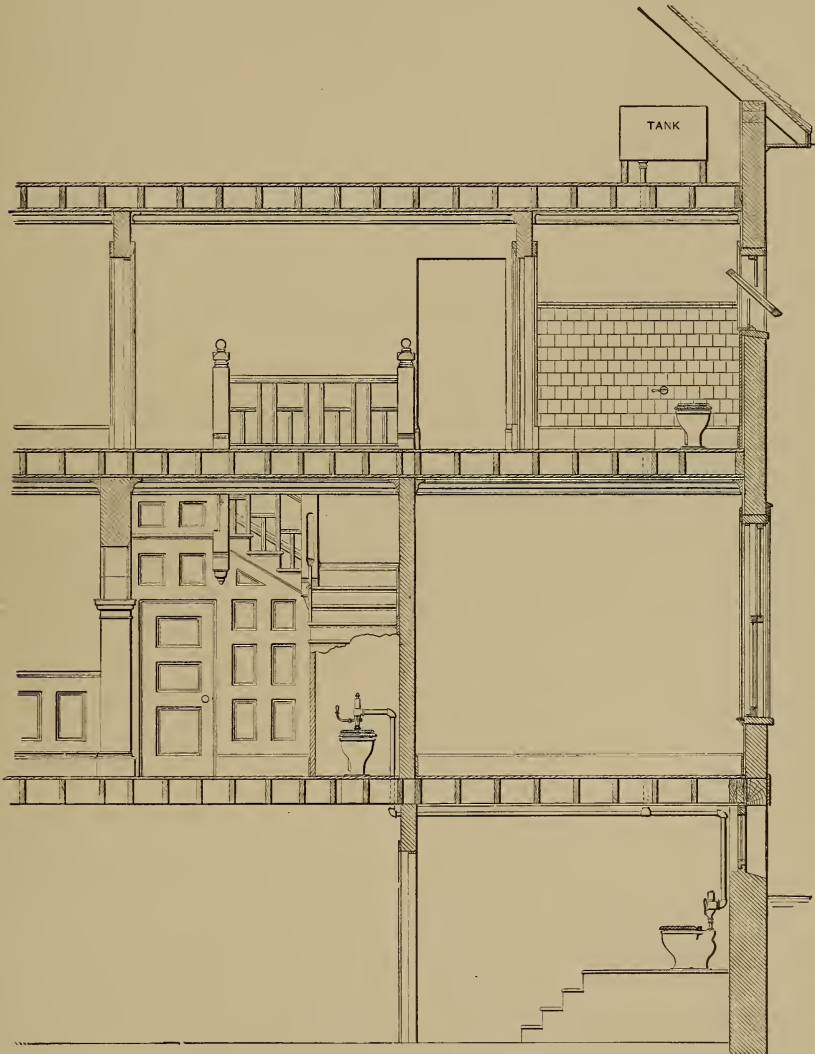
**30-C.**

This section shows a method of installation using one tank only for the building. Any style of closet, with Flushometer, shown in this catalogue can be used, and the relative positions can be altered to suit the requirements.

The above is intended as a suggestion for architects and builders.

Laterals can be carried to any desired point.

Any number of closets can be attached to tank.

SECTIONAL VIEW OF MARINE INSTALLATION

OF KENNEY'S PATENT FLUSHOMETERS.

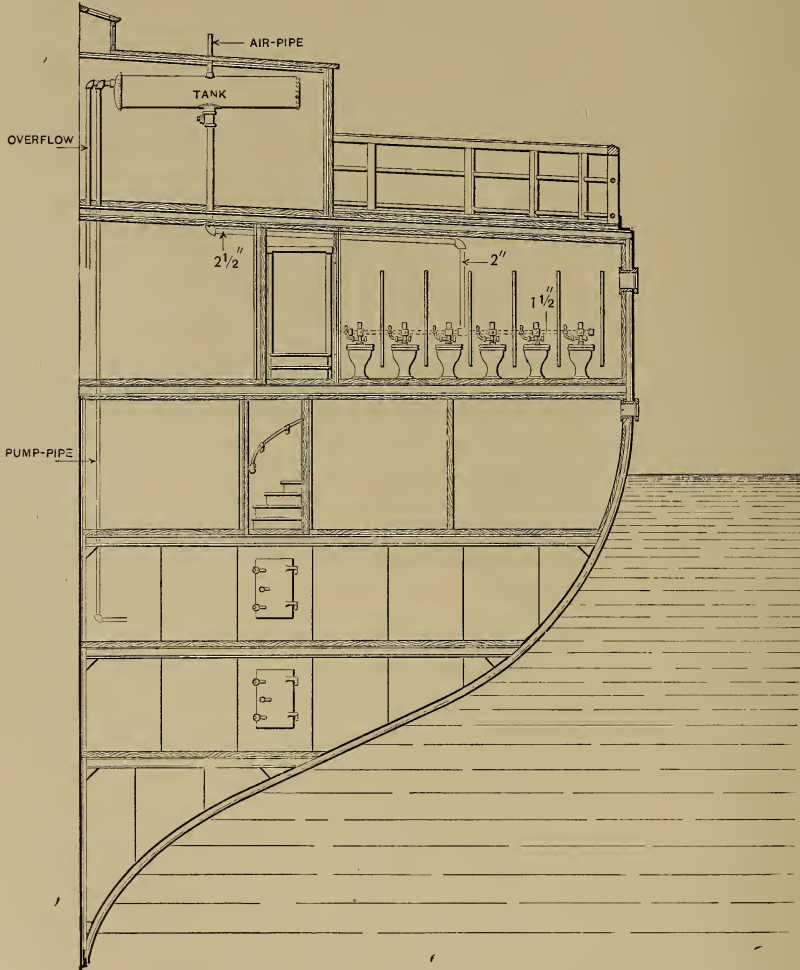

31-C.

The above section shows one of numerous methods used for the application of this system to marine use.

This section shows the method adopted by the U. S. Government on the army transports.

Laterals can be carried to any point. Any number of closets can be attached or arranged in batteries in different parts of the vessels.

SECTIONAL VIEW OF MARINE INSTALLATION FOR YACHTS.

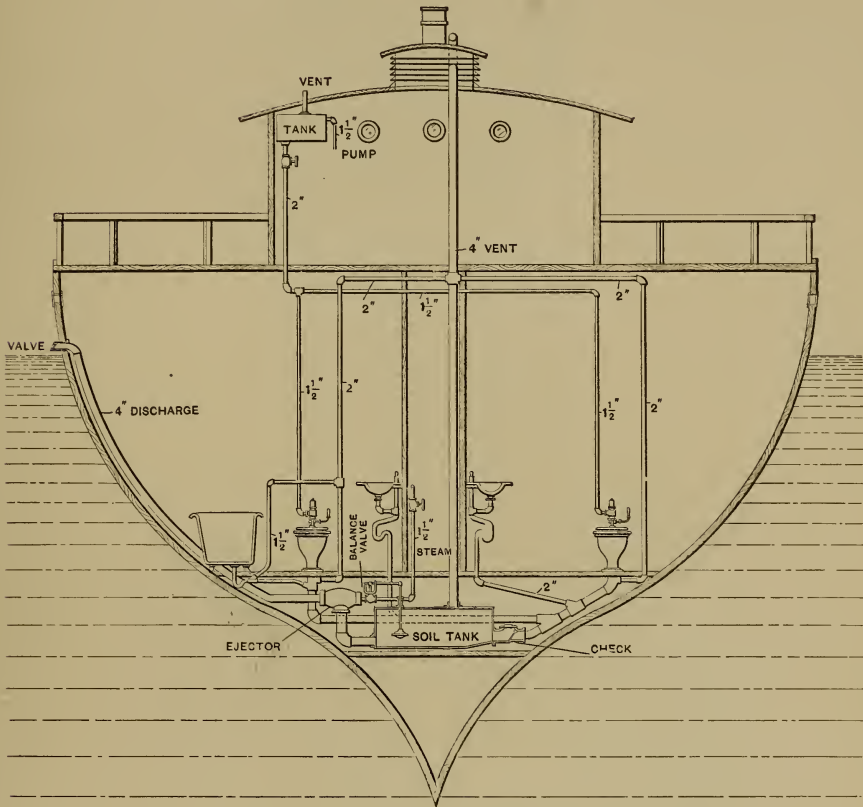

32-C.

This section shows another method employed in the application of the Kenney Flushometer System to marine use.

The supply is obtained from a pump pressure through a 1½-inch pipe carried to a water tank, which is vented in order to prevent its becoming water-bound. From this tank a 2-inch vertical pipe is carried down to a point just below the decks and is there branched into 1½-inch for each water closet.

The waste from the water closet is connected with that of the baths and sinks and carried through a check valve into a soil tank in the hold of the vessel. This tank is 2x3x6 feet in size and has a capacity of over 200 gallons.

The vents are carried by a 4-inch pipe and ventilate through the smoke stack of the vessel, which consumes all gases and odors.

The check valve at the point where the waste pipes connect with the soil tank serves as an effectual barrier against back pressure and the entrance of waste water from the soil tank due to the rolling of the yacht.

From the steam pump a 1½-inch steam pipe is carried to a balance valve, which is operated by a float in the soil tank.

As the tank fills the balance valve is opened, starting an action which draws all of the contents of the soil tank to an ejector having a 4-inch inlet and outlet, which discharges through a sea valve just below the water line of the yacht.

The bottom of the tank is graded to the 4-inch outlet so as to insure complete action.

As an additional protection in case of accident to the float in the soil tank or to the balance valve, a double by-pass can be placed between the balance valve and the ejector. This can be connected with both the steam and the water pipes and used in all cases when the balance valve or float for any reason does not operate.

By use of the Kenney Ejector a 200-gallon tank can be emptied in fifteen seconds, using less than five pounds of steam. A pump, if desired, can be used equally as well.

†“RAMONA” SIPHON JET CLOSET.

PIANO FINISHED WOODWORK.



33-C.

Large, Square Back “Ramona” Siphon Jet Vitreous China Bowl; Quartered Oak Solid Bent, Moulded Zinc Lined Tank, 10½x22x11 inches, 11 gallons capacity, with 1½-inch Special Flush Valve, Union Ball Cock and Special Ramona Tank Board; 1½-inch Quartered Oak Ramona Saddle Seat and Cover, with Nickel-Plated Brass Hinges; 1½-inch Nickel-Plated Flush Pipe, with Nickel-Plated Slip Joint Connection and Nickel-Plated Flush Pipe Post and Bumper; Nickel-Plated Slip Joint Angle Supply Complete, (½-inch I. P. size), Brass Floor Flange and Nickel-Plated Floor Screws and Washers.

For price, weights and measurements, see page 27.

†Carried in San Francisco only.

In Orders and Specifications give Plate Numbers.

† **“RAMONA” SIPHON JET CLOSET.**

Shown on Page 26.

Code.....	Packbode
Plate.....	33-C
Price as described page 26.....	\$45.50

For Copper Lined Tank, add \$1.25.

For Nickel-Plated Supply Pipe to floor, with Nickel-Plated Post, add \$0.15.

For Nickel-Plated Stop Valve for supply to floor, add \$0.90.

If without Brass Floor Flange, deduct \$0.25.

Roughing-in Measurements:

Distance from face of finished wall to center of outlet, 12¼ inches; from center of flush connection to center of bottom supply connection on tank, 6 inches; from center of tank supply to wall, 4 inches; from center of supply inlet in wall to bottom of tank, 9 inches.

Diagram and Measurements of “Ramona” Closet Bowl:

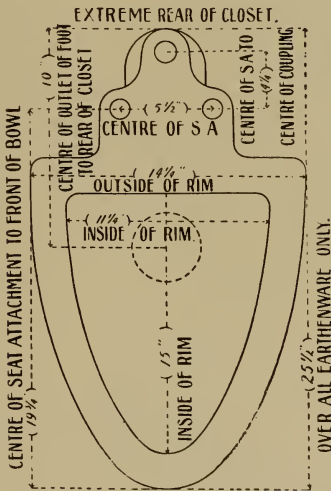

Inlet—1½ inches.
 Outlet—4 inches.
 Height from floor 16¼ inches.

Shipping Weights and Measurements of “Ramona” Closet:

	Package	Weight	Cubic Feet
Bowl.....	1 Crate	60	6½
Tank.....	1 Case	47	4
Tank Board.....	1 Case	20	2
Seat.....	1 Case	23	1¼
Flush Pipe.....	1 Case	10	1
Supply and other trimmings.....	1 Case	4	¼

† Carried in San Francisco only.

164

15

In Orders and Specifications give Plate Numbers.

“NEW GEM” SIPHON JET CLOSET.



36-C.

“New Gem” Embossed Siphon Pinnacle Jet, Vitreous China Bowl; Quartered Oak, Solid Bent, Moulded Zinc Lined Gem Tank, 10x20x11 inches, 9½ gallons capacity, with 1½-inch Special Flush Valve, Union Ball Cock and “Gem” Tank Board; 1½-inch “Gem” Quartered Oak Saddle Seat and Cover with Heavy Nickel-Plated Brass Hinges; 1½-inch Nickel-Plated Flush Pipe with Nickel-Plated Slip Joint Connection and Nickel-Plated Post and Bumper; Nickel-Plated Slip Joint Angle Supply Complete, (½-inch I. P. size), Brass Floor Flange and Nickel-Plated Screws and Washers.

See page 29 for price, weights and measurements.

In Orders and Specifications give Plate Numbers.

“NEW GEM” SIPHON JET CLOSET.

Shown on Page 28.

Code.....	Packages
Plate.....	36-C.
Price as described on page 28.....	\$37.00
Marble Floor Slab extra.	

For Copper Lined Tank, add \$1.25.

For Nickel-Plated Supply to floor with Nickel-Plated Post, add \$0.10.

For Nickel-Plated Slip Joint Stop Valve for supply to floor ½-in. Iron Pipe size, add \$0.90.

If without Brass Floor Flange, deduct \$0.25.

Roughing-in Measurements:

Distance from face of finished wall to center of outlet, 11¾ inches; from center of flush connection to center of bottom supply connection on tank, 6 inches; from center of tank supply to wall, 4 inches; from center of supply inlet in wall to bottom of tank, 9 inches.

Sectional Drawing and Measurements of “New Gem” Bowl:

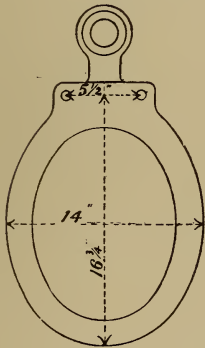

37-C.

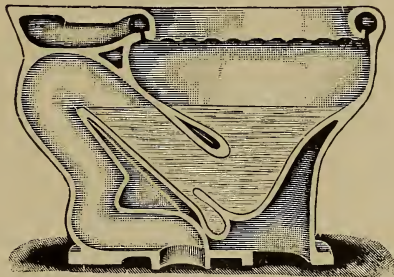

38-C.



39-C.

This bowl has double jet pipe, making it a very strong, positive and quick-working bowl. Has a center outlet from bowl, and has the largest water area of any siphon jet bowl on the market, the water surface measuring 11x13 inches. The usual objectionable noise in the flushing of closet bowls is overcome in the “New Gem” Bowl.

Made with 1½-inch top inlet coupling and seat attachment.

Shipping Weights and Measurements of “New Gem” Closet:

	Package	Pounds	Cubic Feet
Bowl	1 Crate	60	4
Tank	1 Case	47	3½
Tank Board.....	1 Case	20	2
Seat.....	1 Case	20	1
Flush Pipe.....	1 Case	10	1
Supply and other trimmings.....	1 Case	4	¼
		<hr/> 161	<hr/> 11¾

In Orders and Specifications give Plate Numbers.

“BOSTON” SIPHON JET CLOSET.

41-C.

“Boston” Plain Siphon Jet Vitreous China Bowl; Round Cornered Oak Zinc Lined Tank, 9x20x10 inches, 7½ gallons capacity, with 1½-inch Gooseneck Siphon, Noiseless Ball Cock and Oak Tank Board; 1¼-inch Oak Seat and Cover, with Nickel-Plated Hinges; 1½-inch Nickel-Plated Flush Pipe, with Nickel-Plated Slip Joint Connection, Nickel-Plated Flush Pipe Post and Seat Bumper; Nickel-Plated Angle Supply (½-inch I. P. size); Nickel-Plated Screws and Washers.

See page 31 for price, weights and measurements.

In Orders and Specifications give Plate Numbers.

“BOSTON” PLAIN SIPHON JET CLOSET.

Shown on Page 30.

Code.....	Packhoef
Plate.....	41-C
Price as described on page 30.....	\$28.00

For Copper Lined Tank, add \$0.60.

For Nickel-Plated Supply to floor with Nickel-Plated Post, add \$0.75.

For Nickel-Plated Stop Valve for Supply to floor, add \$0.90.

For Brass Floor Flange, add \$0.25.

If without Nickel-Plated Angle Supply, deduct \$0.80.

Roughing-in Measurements:

Distance from face of finished wall to center of outlet, 11¾ inches; from center of flush connection to center of bottom supply connection on tank, 6½ inches; from center of tank supply to wall, 4 inches; from center of supply inlet in wall to bottom of tank, 9 inches.

Sectional Drawing and Measurements of “Boston” Closet Bowl:

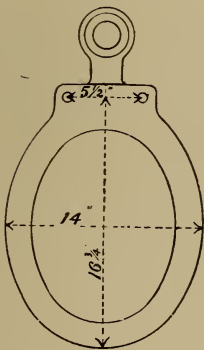

42-C.

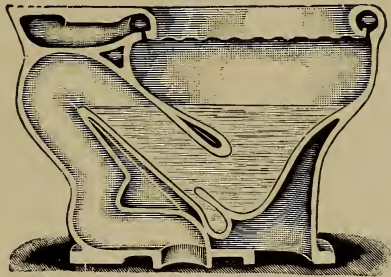

43-C.



44-C.

This Bowl has double jet pipe, making it a very strong, positive and quick-working closet. Has a center outlet from bowl, and has the largest water area of any siphon jet closet on the market, the water surface measuring 11x13 inches.

Made with 1½-inch inlet coupling and seat attachment.

Shipping Weights and Measurements of “Boston” Closet:

	Package	Pounds	Cubic Feet
Bowl.....	1 Crate	63	4½
Tank.....	1 Case	41	2¾
Tank Board.....	1 Case	10	1
Seat.....	1 Case	11	1
Flush Pipe.....	1 Case	10	1
Supply and other trimmings.....	1 Case	4	¼
		<hr/> 139	<hr/> 10½

In Orders and Specifications give Plate Numbers.

“ALFA” WASH DOWN SIPHON CLOSET.



46-C.

“Alfa” Embossed Wash Down Siphon Vitreous China Bowl; Polished Oak, Round Cornered, Moulded, Zinc Lined Tank, 9x20x10 inches, 7½ gallons capacity, with 1¼-inch Siphon Flushing Valve, Noiseless Ball Cock and Polished Oak Tank Board; 1¼-inch Polished Oak Seat and Cover with Nickel-Plated Brass Hinge; 1¼-inch Nickel-Plated Flush Pipe, with Nickel-Plated Adjustable Elbow, Nickel-Plated Flush Pipe, Strap and Seat Bumper; Nickel-Plated Angle Supply (½-inch I. P. size); Nickel-Plated Floor Screws and Washers.

For price, weights and measurements see page 33.

In Orders and Specifications give Plate Numbers.

“ALFA” EMBOSSED WASH DOWN SIPHON CLOSET.

Shown on Page 32.

Code.....	Packraum
Plate.....	46-C.
Price as described on page 32.....	\$22.00

For Copper Lined Tank, add \$0.60.

For Nickel-Plated Supply to floor with Nickel-Plated Strap, add \$0.55.

For Nickel-Plated Stop Valve for supply to floor, add \$0.90.

For Brass Floor Flange, add \$0.25.

If without Nickel-Plated Angle Supply, deduct \$0.80.

Roughing-in Measurements:

Distance from face of finished wall to center of outlet, 13 inches; from center of flush connection to center of bottom supply connection on tank, 6½ inches; from center of tank supply to wall, 4 inches; from center of supply inlet in wall to bottom of tank, 9 inches.

Sectional Drawing and Measurements of “Alfa” Closet Bowl :

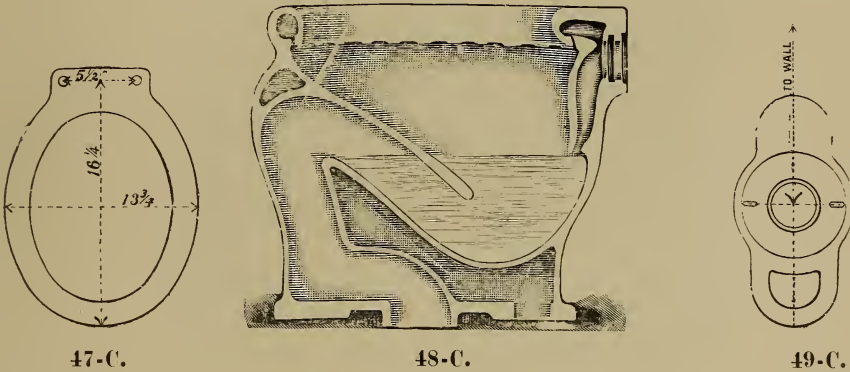

We consider this the best Wash Down Siphon Bowl on the market. It has a jet inside of bowl at back running down to the water line; the full force of the water as it leaves the jet comes directly in contact with the contents of the bowl, forcing the soil through the trap, thus insuring a perfect discharge at each operation of the closet and not depending entirely on siphonic action.

It has a full size round trap throughout, 2¾ inches in diameter; water seal, 3¾ inches, and a surface of water measuring 7½x8½ inches.

Made with 1¼-inch coupling and seat attachment.

Shipping Weight and Measurements of “Alfa” Closet :

	Package	Pounds	Cubic Feet
Bowl.....	1 Crate	50	4
Tank.....	1 Case	39	2¾
Tank Board.....	1 Case	10	1
Seat.....	1 Case	11	1
Flush Pipe.....	1 Case	10	1
Supply and other trimmings.....	1 Case	4	¼
		<u>124</u>	<u>10</u>

In Orders and Specifications give Plate Numbers.

†“ALMA” PLAIN WASH DOWN SIPHON CLOSET.



51-C.

“Alma” Plain Wash Down Siphon Vitreous China Bowl; Oak, Round Cornered, Moulded, Zinc Lined Tank, 9x20x10 inches, 7½ gallons capacity, with 1¼-inch Gooseneck Siphon Flushing Valve, Noiseless Ball Cock and Oak Tank Board; 1¼-inch Oak Seat and Cover; 1¼-inch Nickel-Plated Flush Pipe with Nickel-Plated Adjustable Elbow and Nickel-Plated Flush Pipe Strap; Nickel-Plated Supply to floor with Nickel-Plated Stop Valve and Flange (½-inch I. P. size); Nickel-Plated Floor Screws and Washers.

See page 35 for price, weights and measurements.

† Carried in San Francisco only.

In Orders and Specifications give Plate Numbers.

† **“ALMA” PLAIN WASH DOWN SIPHON CLOSET.**

Shown on Page 34.

Code.....	Packstriff
Plate.....	51-C
Price as described on page 34.....	\$22.00

- For Copper Lined Tank, add \$0.60.
- If with Nickel-Plated Angle Supply, deduct \$1.55.
- For Seat without Cover, deduct \$0.35.
- For Brass Floor Flange, add \$0.25.
- If without Supply to Floor with Strap and Valve, deduct \$2.35.

Roughing-in Measurements:

Distance from face of finished wall to center of outlet, 13 inches; from center of flush connection to center of supply connection on tank, 6½ inches; from center of tank supply to wall, 4 inches.

Sectional Drawing and Measurements of “Alma” Closet Bowl:

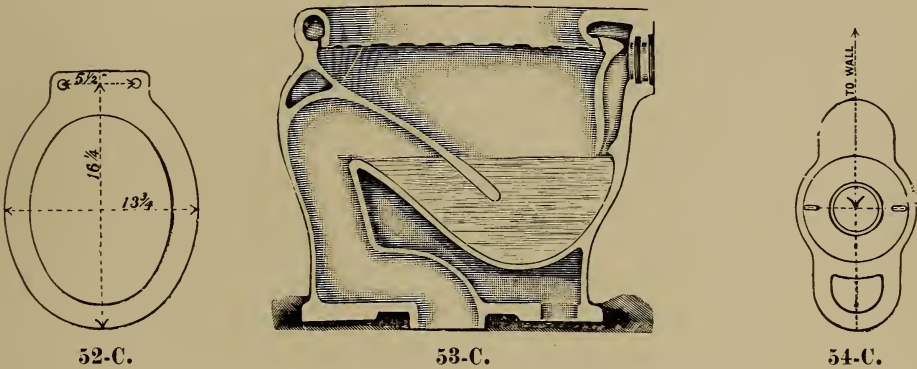

We consider this the best Wash Down Siphon Bowl on the market. It has jet inside of bowl at back running down to the water line. The full force of the water as it leaves the jet comes directly in contact with the contents of the bowl, forcing the soil through the trap, thus insuring a perfect discharge at each operation of the closet and not depending entirely on siphonic action.

It has a full size round trap throughout, 2¾ inches in diameter; water seal, 3¾ inches and surface of water measuring 7½x8½ inches.

Made with 1¼-inch back inlet coupling and seat attachment.

Shipping Weights and Measurements of “Alma” Closet:

	Package.	Pounds.	Cubic Feet.
Bowl.....	1 Crate	50	4
Tank.....	1 Case	39	2¾
Tank Board.....	1 Case	10	1
Seat.....	1 Case	11	1
Flush Pipe.....	1 Case	10	1
Supply and other trimmings.....	1 Case	4	¼
		124	10

†Carried in San Francisco only.

In Orders and Specifications give Plate Numbers.

“GNU ” WASH DOWN SIPHON CLOSET.**61-C.**

“Gnu” Plain Wash Down Siphon Vitreous China Bowl; Oak Hard Finished Round Cornered Zinc Lined Tank, 9x20x10 inches, 7 gallons capacity, with 1¼-inch Gooseneck Siphon, Noiseless Ball Cock and Tank Board; 1¼-inch Oak Seat and Cover; 1¼-inch Nickel-Plated Flush Pipe with Nickel-Plated Adjustable Elbow and Nickel-Plated Flush Pipe Strap and Seat Bumper; Nickel-Plated Screws and Washers.

For price, weights and measurements see page 37.

In Orders and Specifications give Plate Numbers.

“GNU” PLAIN WASH DOWN SIPHON CLOSET.

Shown on Page 36.

Code.....	Packthier
Plate.....	61-C.
Price as described on page 36.....	\$18.00

For Copper Lined Tank, add \$0.60.

For Nickel-Plated Slip Joint Angle Supply, add \$0.80.

For 1/2x3/4-inch Rough Nickel-Plated Angle Valve, add \$0.60.

For Nickel-Plated Supply to floor with Nickel-Plated Strap, add \$1.35.

For Stop Valve for Supply to floor, add \$0.90.

For Brass Floor Flange, add \$0.25.

For Seat without Cover, deduct \$0.35.

Roughing-in Measurements:

Distance from face of finished wall to center of outlet, 9 3/4 inches; from center of flush connection to center of supply connection on tank, 6 1/2 inches; from center of supply connection in tank to wall, 4 inches.

Sectional Drawings and Measurements of “Gnu” Closet Bowl:

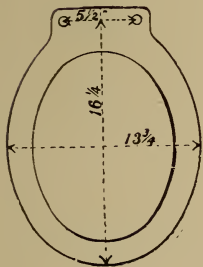

62-C.

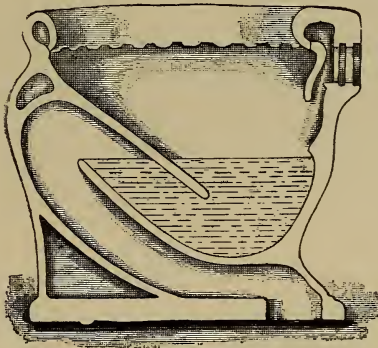

63-C.

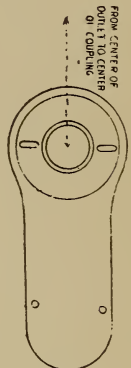

64-C.

This bowl has a full size round trap throughout, 2 1/4 inches in diameter; with seal, 3 3/4 inches, and surface of water measuring 7x8 inches.

The jet inside of the bowl at back does not run down to the water line.

Made with 1 1/4-inch inlet coupling, seat attachment, and rear outlet.

Shipping Weights and Measurements of “Gnu” Closet:

	Package	Pounds	Cubic Feet
Bowl.....	1 Crate	45	4
Tank.....	1 Case	25	2
Tank Board.....	1 Case	10	1
Seat.....	1 Case	11	1
Flush Pipe.....	1 Case	10	1
		101	9

In Orders and Specifications give Plate Numbers.

“ NEW DOME ” SIPHON JET LOW DOWN CLOSET.



66-C.

“New Dome” Embossed Siphon Pinnacle Jet Vitreous China Bowl; Bent Oak Piano Finish, Zinc Lined Tank, 19 x 6 x 16 inches, 9½ gallons capacity, with 2-inch Eastwood Flushing Valve, High Pattern Ball Cock, Nickel-Plated Push Button and Nickel-Plated Flush Connection; 1½-inch Quartered Oak Piano Finish Saddle Seat and Cover with Nickel-Plated Hinges; Nickel-Plated Angle Supply (½-inch I. P. size); Brass Floor Flange and Nickel-Plated Screws and Washers.

Code.....	Packwag
Price as described.....	\$32.40
Shipping weight, lbs.....	122
Shipping measurement, cubic feet.....	8½

For Copper Lined Tank, add \$0.75. For Marble Top Tank, add \$1.75.
 Straight Supply to Floor, same price as Angle Supply.
 If without Floor Flange, deduct \$0.25.

Roughing-in Measurements:

Distance from face of finished wall to center of outlet, 14¼ inches; from center of flush coupling to center of supply coupling on tank, 8 inches; from bottom of tank to center of supply inlet in wall, 9 inches; from face of finished wall to center of supply coupling on tank, 3 inches.

In Orders and Specifications give Plate Numbers.

“RUSH” SIPHON JET LOW DOWN CLOSET.



70-C.

“Rush” Embossed Siphon Pinnacle Jet Vitreous China Bowl; Oak Zinc Lined Tank, 19x6x16 inches, 9½ gallons capacity, with 2-inch Eastwood Flushing Valve, High Pattern Ball Cock, Nickel-Plated Push Button and Nickel-Plated Flush Connection; 1¼-inch Oak Seat and Cover; Nickel-Plated Angle Supply (½-inch I. P. size); Nickel-Plated Screws and Washers.

Code.....	Paclite
Price as described.....	\$29.00
Shipping weight, lbs.....	125
Shipping measurement, cubic feet.....	8½

For Copper Lined Tank, add \$0.75. For Marble Top Tank, add \$1.75.

Nickel-Plated Straight Supply to Floor, same price as Angle Supply.

For Brass Floor Flange, add \$0.25.

Roughing-in Measurements:

Distance from face of finished wall to center of outlet, 14¼ inches; from center of flush connection to center of supply connection on tank, 8 inches; from center of supply connection on tank to wall, 3 inches; from bottom of tank to center of supply inlet in wall, 9 inches.

In Orders and Specifications give Plate Numbers.

“EDDY” SIPHON JET LOW DOWN CLOSET.



72-C.

“Eddy” Plain Siphon Pinnacle Jet Vitreous China Bowl; Oak Hard Finish Zinc Lined Tank, 19x6x16 inches, 9½ gallons capacity, with 2-inch Eastwood Flushing Valve, High Pattern Ball Cock, Nickel-Plated Push Button and Nickel-Plated Flush Connection; 1¼-inch Oak Hard Finished Seat and Cover; Nickel-Plated Supply to Floor (¾-in. I. P. size); Nickel-Plated Screws and Washers.

Code.....	Paclome
Price, as described.....	\$28.00
Shipping weight, lbs.....	125
Shipping measurement, cubic feet.....	8½

For Copper Lined Tank, add \$0.75. For Marble Top Tank, add \$1.75.
 For Nickel-Plated Angle Supply (½-inch I. P. size), complete, add \$0.35.
 For Brass Floor Flange, add \$0.25.

Roughing-in Measurements :

Distance from face of finished wall to center of outlet, 14¼ inches; from center of flush connection to center of supply connection on tank, 8 inches; from center of supply connection on tank to wall, 3 inches; from bottom of tank to center of supply inlet in wall, 9 inches.

In Orders and Specifications give Plate Numbers.

“CHINO” WASH DOWN SIPHON LOW DOWN CLOSET.



74-C.

“Chino” Embossed Siphon Wash Down Vitreous China Bowl; Oak Zinc Lined Tank, 19x6x16 inches, 9½ gallons capacity, with 2-inch Eastwood Flushing Valve, High Pattern Ball Cock, Nickel-Plated Push Button and 2-inch Nickel-Plated Adjustable Flush Connection; 1¼-inch Oak Seat and Cover; Nickel-Plated Angle Supply (½-inch I. P. size); Nickel-Plated Floor Screws and Washers.

Marble Floor Slab extra.

Code.....	Pacotilo
Price as described.....	\$23.00
Shipping weight, lbs.....	125
Shipping measurements, cubic feet.....	8½

For Copper Lined Tank, add \$0.75. For Marble Top Tank, add \$1.75.

Nickel-Plated Straight Supply to Floor, same price as Angle Supply.

For Brass Floor Flange, add \$0.25.

Roughing-in Measurements:

Distance from face of finished wall to center of outlet, 13 inches; from center of flush connection to center of supply connection on tank, 8 inches; from center of tank supply to wall, 3 inches from bottom of tank to center of supply inlet in wall, 9 inches.

In Orders and Specifications give Plate Numbers.

“VOLGA” WASH DOWN SIPHON LOW DOWN CLOSET.



76-C.

“Volga” Plain Wash Down Siphon Vitreous China Bowl; Oak Zinc Lined Tank, 19x6x16 inches, 9½ gallons capacity, with 2-inch Eastwood Flushing Valve, High Pattern Ball Cock, Nickel-Plated Push Button and 2-inch Nickel-Plated Adjustable Flush Connection; 1¼-inch Oak Seat and Cover; Nickel-Plated Angle Supply (½-inch I. P. size); Nickel-Plated Floor Screws and Washers.

Marble Floor Slab extra.

Code.....	Pacouris
Price as described.....	\$22.50
Shipping weight, lbs.....	125
Shipping measurement, cubic feet.....	8½

For Copper Lined Tank, add \$0.75.

For Marble Top Tank, add \$1.75. For Floor Flange, add \$0.25.

Nickel-Plated Supply to Floor, same price as Angle Supply. For Seat without Cover, deduct \$0.35.

Roughing-in Measurements:

Distance from face of finished wall to center of outlet, 13 inches; from center of flush connection to center of supply connection on tank, 8 inches; from center of supply connection to wall, 3 inches; from bottom of tank to center of supply inlet in wall, 9 inches.

In Orders and Specifications give Plate Numbers.

“TOGO” WASH DOWN SIPHON LOW DOWN CLOSET.



78-C.

“Togo” Plain Wash Down Siphon Vitreous China Bowl; Oak Hard Finished Zinc Lined Tank, 19x6x16 inches, 9½ gallons capacity, with 2-inch Rubber Ball Flushing Valve, High Pattern Ball Cock, Nickel-Plated Push Button and 2-inch Nickel-Plated Adjustable Elbow Flush Connection; 1¼-inch Oak Hard Finished Seat and Cover; Nickel-Plated Angle Valve (½x¾-inch I. P. size); Nickel-Plated Screws and Washers.

Code.....	Pactador
Price as described.....	\$20.50
Shipping weight, lbs.....	120
Shipping measurement, cubic feet.....	8½

For Copper Lined Tank, add \$0.75. For Marble Top Tank, add \$1.75.

For Floor Flange, add \$0.25. For Seat without Cover, deduct \$0.35.

Nickel-Plated Straight Supply to Floor, same price as Angle Supply.

Roughing-in Measurements:

Distance from face of finished wall to center of outlet, 13 inches; from center of flush connection to center of supply connection on tank, 8 inches; from center of supply connection on tank to wall, 3 inches.

In Orders and Specifications give Plate Numbers.

“HILO” WASHOUT CLOSET.



80-C.

“Hilo” Open Trap Embossed Regular Front Washout Bowl; Round Cornered Moulded Oak Zinc Lined Tank, 20x9x10-inches, 7½ gallons capacity, with 1¼-inch Siphon, Noiseless Ball Cock and Tank Board; 1¼-inch Oak Seat and Cover; 1¼-inch Nickel-Plated Flush Pipe with Nickel-Plated Adjustable Elbow and Nickel-Plated Flush Pipe Strap; Nickel-Plated Angle Supply (½-inch I. P. size); Nickel-Plated Floor Screws and Washers.

Marble Floor Slabs extra.

Code	Pactaram
Price as described.....	\$16.50
Shipping weight, lbs.....	99
Shipping measurement, cubic feet	7¾

Roughing-in Measurements:

Distance from face of finished wall to center of outlet, 9 inches.

In Orders and Specifications give Plate Numbers.

“RAINIER” WASHOUT CLOSET.



28-C.

“Rainier” Open Trap Plain Regular Front Washout Bowl; Beaded Oak Tank, 17x8x10 inches, 5½ gallons capacity, with 1¼-inch Gooseneck Siphon, Noiseless Ball Cock and Tank Board; 1¼-inch Oak Seat and Cover; 1¼-inch Nickel-Plated Flush Pipe with Nickel-Plated Flush Pipe Strap and Nickel-Plated Adjustable Elbow; Nickel-Plated Angle Supply (½-inch I. P. size); Nickel-Plated Screws and Washers.

Code.....	Pacticio
Price as described.....	\$14.50
Shipping weight, lbs.....	90
Shipping measurement, cubic feet.....	7½

Roughing-in Measurements:

Distance from face of finished wall to center of outlet, 9 inches.

In Orders and Specifications give Plate Numbers.

"ALAMEDA" OFFSET CLOSET.

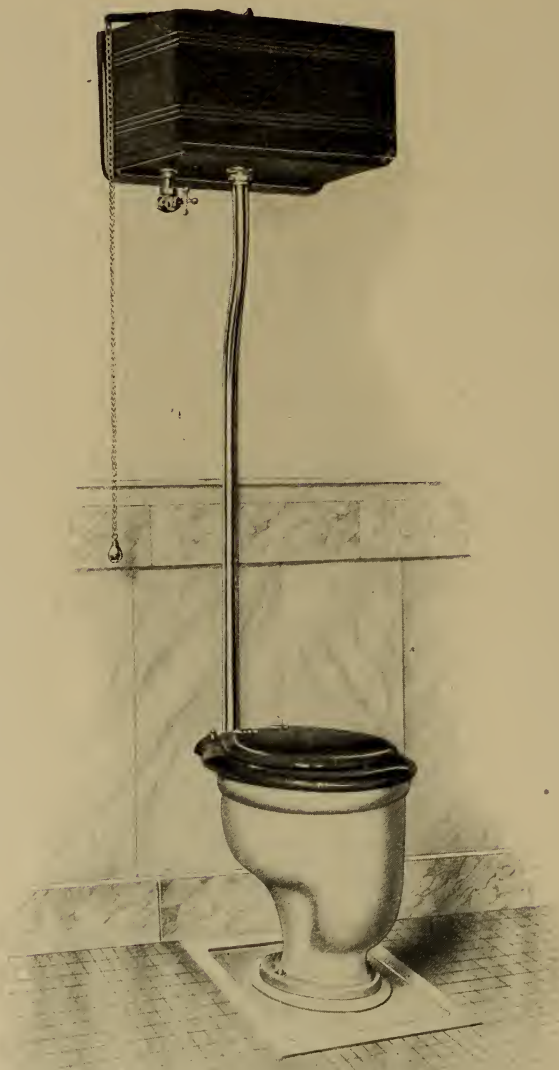

84-C.

"Alameda" Plain Offset Regular Front Washout Bowl; Beaded and Varnished Oak Zinc Lined Tank, 17x8x10 inches, 5½ gallons capacity, with ¼-inch Gooseneck Siphon, Ball Cock and Tank Board; ¼-inch Oak Seat and Cover; ¼-inch Nickel-Plated Flush Pipe and Nickel-Plated Adjustable Elbow; ½x¾-inch Nickel-Plated Angle Valve; Nickel-Plated Floor Screws and Washers. Marble Floor Slabs extra.

Code.....	Pactilise
Price as described.....	\$14.40
Shipping weight, lbs.....	85
Shipping measurement, cubic feet.....	7½

Roughing-in Measurements:

Distance from face of finished wall to center of outlet, 11½ inches.

In Orders and Specifications give Plate Numbers.

“AJAX” HOPPER CLOSET.



86-C.

“Ajax” Plain Oval Flushing Rim Porcelain Hopper; Beaded and Varnished; Oak Zinc Lined Tank, 17 x 8 x 10 inches, 5½ gallons capacity, with ¼-inch Gooseneck Siphon, Noiseless Ball Cock and Tank Board; ¼-inch Oak Seat and Cover; ¼-inch Nickel-Plated Flush Pipe and Nickel-Plated Adjustable Elbow; Nickel-Plated Screws and Washers.

Code.....	Pactison
Price as described.....	\$13.60
Shipping weight, lbs.....	75
Shipping measurement, cubic feet.....	6½

Roughing-in Measurement:

Distance from face of finished wall to center of outlet, 10 inches.

In Orders and Specifications give Plate Numbers.

“PINAL” HOPPER CLOSET.



88-C.

“Pinal” Plain Round Flushing Rim Porcelain Hopper; Beaded and Varnished Oak Zinc Lined Tank, 17x8x10 inches, 5½ gallons capacity, with ¼-inch Gooseneck Siphon, Noiseless Ball Cock and Tank Board; ¼-inch Oak Seat and Cover; ¼-inch Nickel-Plated Flush Pipe and Nickel-Plated Adjustable Elbow; Nickel-Plated Screws and Washers.

Code.....	Pactoler
Price as described.....	\$11.75
Shipping weight, lbs.....	71
Shipping measurement, cubic feet.....	6½

Roughing-in Measurement:

Distance from face of finished wall to center of outlet, 11 inches.

In Orders and Specifications give Plate Numbers.

“INDUS” ENAMELED SIPHON JET CLOSET.



90-C.

“Indus” Porcelain Enameled, inside and outside, Siphon Jet Bowl with 1½-inch Brass Flush Inlet and Improved Roll Top Flushing Rim with Concealed Joint; Round Cornered Oak Zinc Lined Tank with 1½-inch Flushing Valve, Noiseless Ball Cock and Tank Board; 1¼-inch Oak Seat and Cover with Nickel-Plated Brass Hinges; 1½-inch Nickel-Plated Brass Flush Pipe with Post and Slip Joint Connection; Nickel-Plated Angle Supply (½-inch I. P. size); Nickel-Plated Screws and Washers.

Code.....	Pactolide
Price as described.....	\$27.25
Shipping weight, lbs.....	142
Shipping measurement, cubic feet.....	8⅓

Roughing-in Measurement :

Distance from face of finished wall to center of outlet, 12 inches.

In Orders and Specifications give Plate Numbers.

“OXUS” ENAMELED WASH DOWN SIPHON CLOSET.



92-C.

“Oxus” Porcelain Enameled, inside and outside, Wash Down Siphon Bowl with 1¼-inch Flush Inlet and Improved Roll Top Flushing Rim with Concealed Joint; Round Cornered Oak Zinc Lined Tank with 1¼-inch Flush Valve, Noiseless Ball Cock and Tank Board; 1¼-inch Oak Seat and Cover with Nickel-Plated Brass Hinges; 1¼-inch Nickel-Plated Flush Pipe with Nickel-Plated Strap and Nickel-Plated Adjustable Elbow; Nickel-Plated Angle Supply (½-inch I. P. Size); Nickel-Plated Screws and Washers.

Code	Pactyas
Price as described.....	\$24.80
Shipping weight, lbs.....	147
Shipping measurement, cubic feet.....	8¼

Roughing-in Measurement:

Distance from face of finished wall to center of outlet, 13 inches.

In Orders and Specifications give Plate Numbers.

“TIGRIS” ENAMELED SIPHON JET LOW DOWN CLOSET.



94-C.

“Tigris” Porcelain Enameled, inside and outside, Siphon Jet Bowl and 2-inch Brass Flush Inlet and Improved Roll Top Flushing Rim with Concealed Joint; Bent Oak, Piano Finish, Zinc Lined Tank with 2-inch Eastwood Flush Valve, High Pattern Ball Cock, Nickel-Plated Push Button and Nickel-Plated Flush Connection; 1 1/4-inch Oak Seat and Cover with Nickel-Plated Brass Offset Post Hinges; Nickel-Plated Angle Supply (1/2-inch I. P. size); Nickel-Plated Screws and Washers.

Code.....	Pacuvian
Price as described.....	\$29.50
Shipping weight, lbs.....	145
Shipping measurement, cubic feet.....	8 1/2

Roughing-in Measurements :

Distance from face of finished wall to center of outlet, 13 3/4 inches.

In Orders and Specifications give Plate Numbers.

**“ELBE” ENAMELED WASH DOWN SIPHON LOW
DOWN CLOSET.**



96-C.

“Elbe” Porcelain Enameled, inside and outside, Wash Down Siphon Bowl with 2-inch Brass Flush Inlet and Improved Roll Top Flushing Rim with Concealed Joint; Round Cornered Oak Zinc Lined Tank with 2-inch Eastwood Flushing Valve, High Pattern Ball Cock, Nickel-Plated Push Button and Nickel-Plated Elbow Flush Connection; 1¼-inch Oak Seat and Cover with Nickel-Plated Brass Offset Post Hinges; Nickel-Plated Angle Supply (½-inch I. P. size); Nickel-Plated Screws and Washers.

Code.....	Paddel
Price as described.....	\$26.60
Shipping weight, lbs.....	160
Shipping measurement, cubic feet.....	8½

If with Bowl Enameled inside and Painted outside, deduct \$1.65.

Roughing-in Measurement:

Distance from face of finished wall to center of outlet, 15 inches.

In Orders and Specifications give Plate Numbers.

“GILA” ENAMELED WASHOUT CLOSET.



98-C.

“Gila” Porcelain Enameled, inside and outside Washout Bowl with 1¼-inch Brass Flush Inlet and Improved Roll Top Flushing Rim with Concealed Joint; Round Cornered Oak Zinc Lined Tank with 1¼-inch Gooseneck Siphon, Noiseless Ball Cock and Oak Tank Board; 1¼-inch Oak Seat and Cover with Nickel-Plated Hinges; 1¼-inch Nickel-Plated Flush Pipe with Nickel-Plated Strap and Nickel-Plated Adjustable Elbow; Nickel-Plated Angle Supply (½ inch I. P. size); Nickel-Plated Screws and Washers.

Code.....	Paddler
Price as described.....	\$19.25
Shipping weight, lbs.....	133
Shipping measurement, cubic feet	8¼

Roughing-in Measurement:

Distance from face of finished wall to center of outlet, 9½ inches.

In Orders and Specifications give Plate Numbers.

“AUTO” ENAMELED HOPPER CLOSET.



100-C.

“Auto” Tall Oval Hopper, Porcelain Enameled Inside, Painted Outside, with Roll Top Flushing Rim; Oak Beaded and Varnished Zinc Lined Tank with 1¼-inch Gooseneck Siphon, Noiseless Ball Cock and Oak Tank Board; 1-inch Oak Seat, no Cover; 1¼-inch Nickel-Plated Flush Pipe with Nickel-Plated Adjustable Elbow and Nickel-Plated Flush Pipe Strap.

Code.....	Paddock
Price as described.....	\$12.40
Shipping weight, lbs.....	97
Shipping measurement, cubic feet.....	7¼

Roughing-in Measurement:

Distance from face of finished wall to center of outlet, 9 inches.

In Orders and Specifications give Plate Numbers.

PRISON CLOSET AND LAVATORY.



101-C.

Prison Porcelain Enameled Inside Closet, with 2-inch Outlet and Special Flanged Trap, Enameled Combined Seat and Flush Rim and Heavy Special Pattern Prison Closet Valve. Porcelain Enameled Inside Extra Heavy one piece Prison Lavatory with Self-closing Extra Heavy Faucet and Waste Coupling drilled for bolting to cell wall.

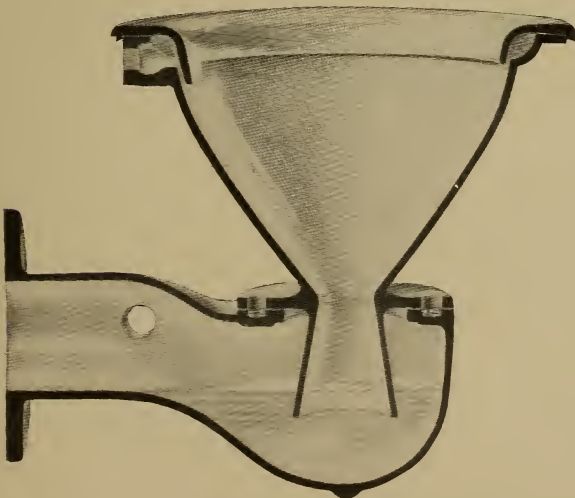

Cut Shows Sectional View of Prison Closet.

Code.....	Paddult
Price, as described.....	\$24.00
Shipping weight, lbs.....
Shipping measurement, cubic feet..

Above price does not include pipe and fittings for connecting Lavatory with Closet.

Closet only, enameled inside, \$15.00.

Heavy Pattern Valve, only \$2.50.

Lavatory with Self-closing Faucet, only \$6.50.

In Orders and Specifications give Plate Numbers.

“NEMO” ENAMELED HOPPER CLOSET.



102-C.

“Nemo” Tall Round Hopper, Porcelain Enameled Inside, Painted Outside, with Roll Top Flushing Rim; Oak Beaded and Varnished Zinc Lined Tank with 1/4-inch Gooseneck Siphon, Noiseless Ball Cock and Oak Tank Board; 1/4-inch Oak Seat and Cover; 1/4-inch Nickel-Plated Flush Pipe with Nickel-Plated Adjustable Elbow and Nickel-Plated Flush Pipe Strap.

Code.....	Padecido
Price as described.....	\$12.50
Shipping weight, lbs.....	96
Shipping measurement, cubic feet.....	7 1/4

Roughing-in Measurement:

Distance from face of finished wall to center of outlet, 12 inches.

In Orders and Specifications give Plate Numbers.

“KELLY” AUTOMATIC WATER CLOSET.



104-C.

Porcelain Siphon Jet Bowl with Kelly's patent Hornless Connection; Galvanized Tank and Brackets; Iron Flush Pipe and Kelly's Automatic Valve; Oak Seat attached to Valve; Nickel-Plated Screws and Washers.

The action of the seat operates the valve and gives a strong after flush. There are no springs, weights or levers used. It is operated entirely by water pressure. When the seat is pressed down, the tank fills as far as the water pressure will compress the air in the tank, and when the seat is released, the compressed air drives the water from the tank into the closet with great force and will flush out the closet thoroughly and leave a re-fill of clean water.

Code	Padelica
Price as described	\$30.30
Shipping weight, lbs	96
Shipping measurement, cubic feet	5½

Packed one in a barrel or eight in a crate.

Roughing-in Measurement:

Distance from face of finished wall to center of outlet,.....inches.

In Orders and Specifications give Plate Numbers.

**“KELLY” SELF-ACTING FROST-PROOF
AFTER FLUSH CLOSET.**



106-C.

Oval Porcelain Hopper with Oak Seat; Galvanized Iron Tank and Brackets; Kelly's Frost-Proof Valve with weights and chain. We do not furnish Pipe or Trap with this combination.

Code.....	Padelot
Price as described.....	\$28.00
Shipping weight, lbs.....	,04
Shipping measurement, cubic feet.....	5½
For above Combination with Oval Flush Rim Hopper Enameled Inside, deduct \$1.20.	

Packed one in a barrel or ten in a crate.

Roughing-in Measurement:

Distance from face of finished wall to center of outlet,..... inches.

In Orders and Specifications give Plate Numbers.

“KELLY” FROST-PROOF CLOSET.



108-C.

Cast Iron Hopper, Enameled Inside, with Oak Self-Raising Seat; Kelly's Frost-Proof Valve with chain weights and couplings. We do not furnish Pipes and Traps with this combination.

The water runs while the seat is occupied, and shuts off and empties the pipe above the valve when the seat is released.

Packed one in a barrel or eighteen in a crate.

Code.....	Paderelle
Price as described.....	\$13.50
Shipping weight, lbs.....	79
Shipping measurement, cubic feet.....	5½

Packed one in a barrel or eighteen in a crate.

Roughing-in Measurement:

Distance from face of finished wall to center of outlet,.....inches.

In Orders and Specifications give Plate Numbers.

AUTOMATIC SIPHON EDUCATION RANGE CLOSET.

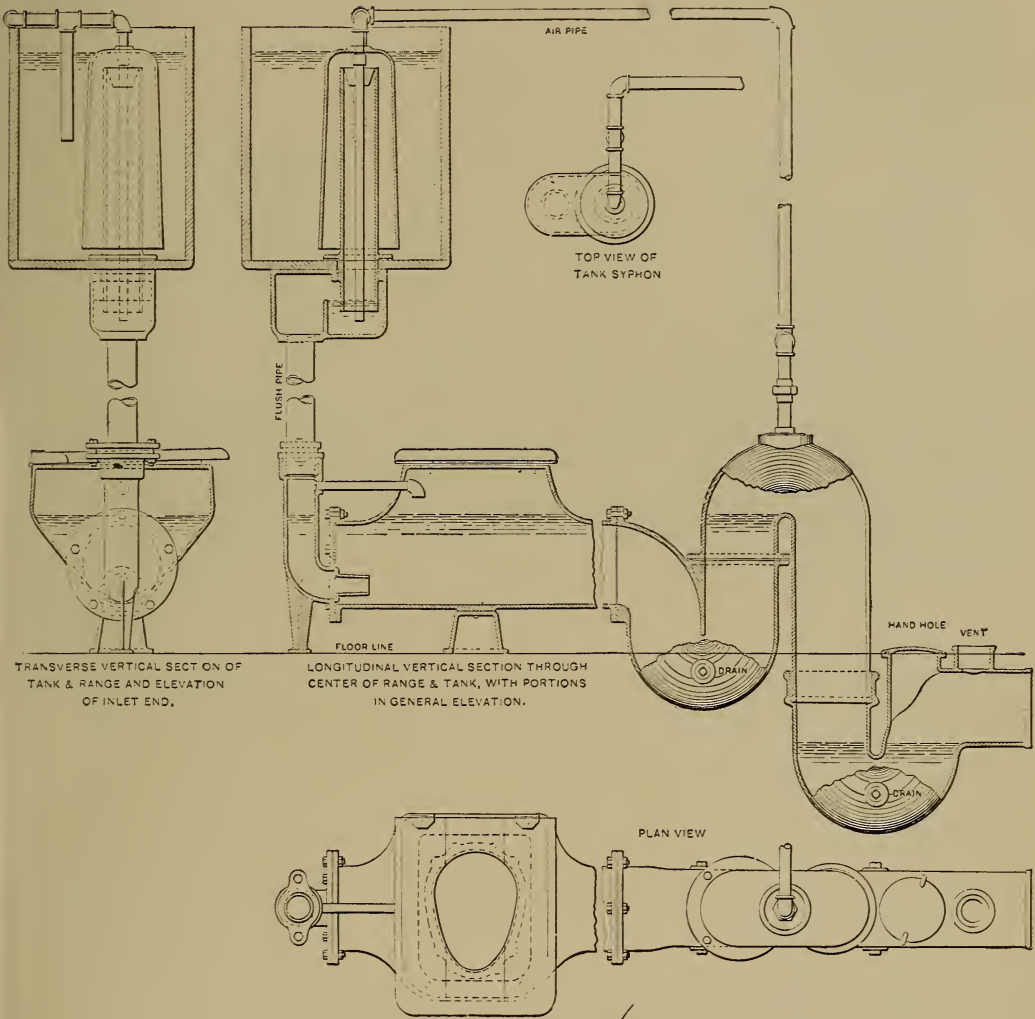

An accurate knowledge of the relative position of parts will be gained by reference to the above drawings.

Full instructions for erecting and operating are furnished with each fixture.

Blue prints giving detailed dimensions of every part of complete Range, and full information essential to "roughing-in," will be sent on request.

This fixture, while already well known, has been improved so that the interval between flushes can be regulated as desired, but the minimum flush is much shorter than will ever be demanded by actual service conditions.

In Orders and Specifications give Plate Numbers.

AUTOMATIC SIPHON EDUCATION RANGE CLOSET.

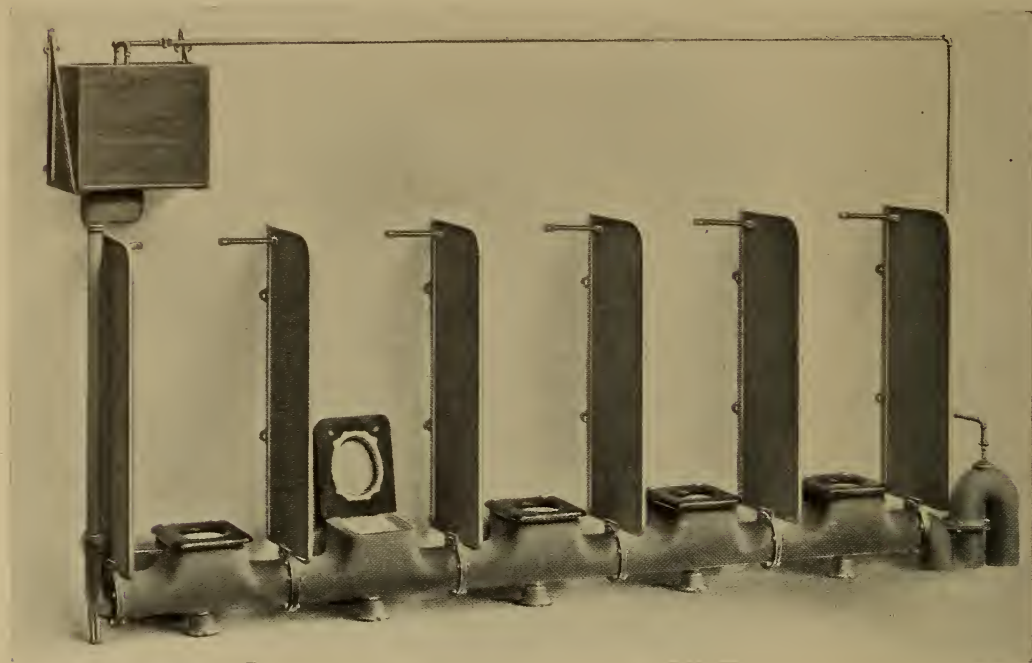

109-C.

With Siphon Education Copper-Lined Wood Tank; Galvanized Iron Flush Pipe; Hinged Oak Seats with Iron Reinforcements and Painted Iron Partitions.

No. of Seats.	24-Inch Seats.		24-Inch Seats.		27-Inch Seats.		27-Inch Seats.	
	Code.	Painted.	Code.	Enameled.	Code.	Painted.	Code.	Enameled.
3	Paderia	\$ 94.25	Padersize.....	\$107.50	Padetagers..	\$ 97.75	Padetless.....	\$112.25
4	Paderilla.....	112.00	Padership.....	128.50	Padetao	116.00	Padetmauer..	134.50
5	Paderillas.....	132.00	Paderslide....	152.00	Padetaria	137.50	Padeton.....	159.50
6	Paderota	151.00	Paderslips....	174.25	Padetatos	157.25	Padetonic....	183.50
7	Paderraeo.....	170.75	Padersnow....	197.50	Padeteggi....	178.00	Padetasas....	208.00
8	Padersail	189.00	Padersoon....	219.00	Padeteras	197.50	Padetudo	231.25
9	Paderscent...	208.50	Paderuco.....	242.25	Padeterizo....	219.25	Padevamo....	257.00
10	Paderschon ..	227.50	Paderzas.....	264.50	Padeteval....	240.25	Padeveld....	280.75
11	Padersee	247.50	Padesa	287.25	Padeticina....	261.50	Padevet	305.75
12	Padershad....	267.25	Padesana.....	310.00	Padeting	282.25	Padevota	330.50
13	Padershake....	287.75	Padesis.....	333.75	Padetingly ..	303.75	Padezalig	355.50
14	Padershoes...	307.25	Padessi.....	357.00				
15	Padershot....	327.50	Padessie.	380.75				

If Seat Covers are wanted, add \$1.00 each.

For above Range without Partition, deduct \$6.50 for each Partition.

For above Range with Painted Cast Iron Backs, add for 24-inch Seat Range \$6.50; 27-inch Seat Range, \$7.50 for each Back.

If Enameled Iron Seat Tops are desired in place of Wood Seats, add \$2.25 for each Seat.

If Seats are wanted stationary instead of hinged, deduct \$0.50 for each Seat.

Unless otherwise ordered, Range with Enameled Interior, 24-inch Seats and Outlet at right end, as shown, will be sent.

Sectional views of Range are shown on page 58A.

In Orders and Specifications give Plate Numbers.

PARSONS' TROUGH WATER CLOSET.

Patented.

FOR SCHOOLS, FACTORIES, WORKSHOPS, RAILWAY STATIONS, TENEMENT HOUSES AND PUBLIC PLACES.

The Parsons' Trough Water Closet has been successfully used in Schools, Factories, etc., for many years past. The arrangement of each basin in the section at a slightly lower level with its weir or dam toward the outlet is novel and important, securing an equal flush to each with a minimum quantity of water—an important consideration when meter rates have to be paid. The flush is automatic at any desired interval.

The Closet comprises a system of two, three, four, five or six, to twelve-part Washout Water Closets combined in one apparatus, operated by one tank up to a six-part Closet; above six and up to a twelve-part Closet the apparatus is operated by two tanks, one at each end, but with a single outlet.

The result secured in the design of the Parsons' Trough Water Closet is the advantage of having a body of water, such as is found in a Washout Closet, that may be automatically removed with all its contents at predetermined intervals.

The Flush Tank may be easily regulated to empty its contents with certainty at any given period; the quantity of water may also be controlled as desired.

The Trough, having no valve or complicated outlet, will not be choked up by any material which can pass through the outlet pipe, and this pipe may be of any size.

During hours when not in use, the water can be shut off.

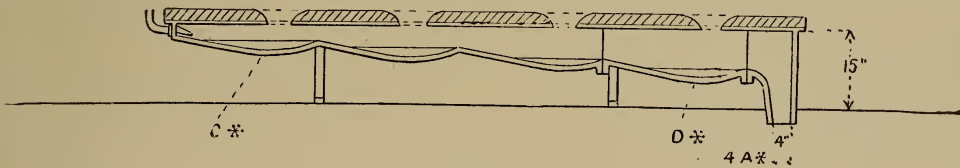

110-C.

Section of Four Closets.

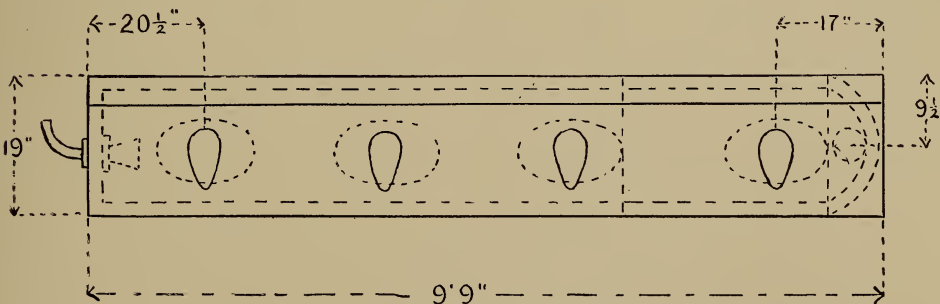

111-C.

Plan of Four Closets.

Distance between centers of basins, 27 inches.

The inlet and outlet connections of the Parson's Trough Water Closets being in the center of the ends, they can be set for either right or left hand outlet as desired.

In Orders and Specifications give Plate Numbers.

PARSONS' TROUGH WATER CLOSET.

(Patented.)

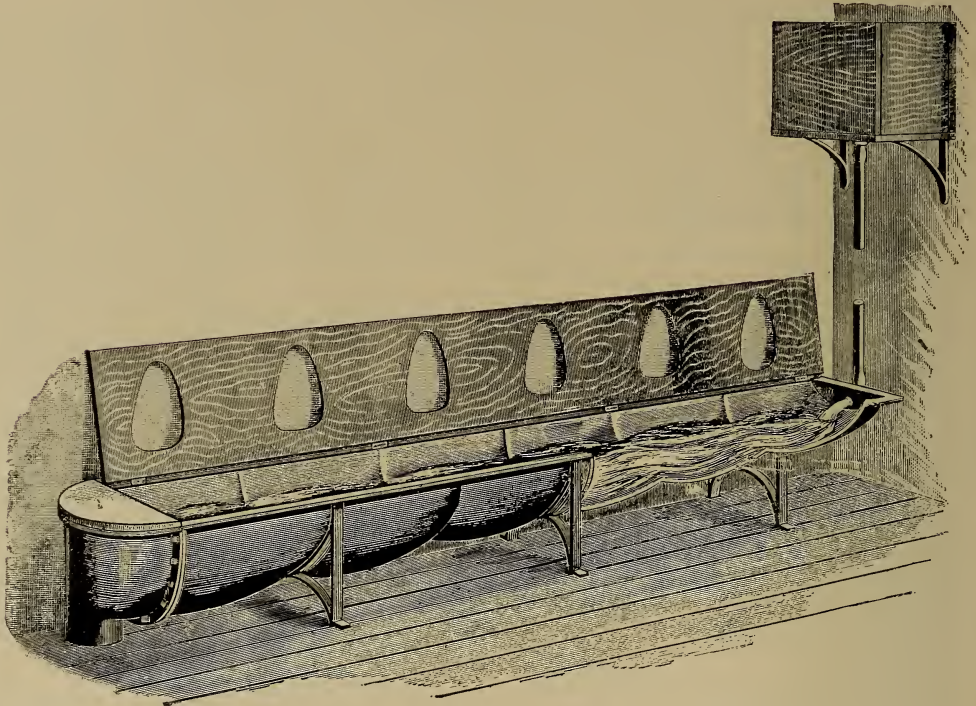
**112-C.**

Parsons' Cast Iron Trough Water Closet with Iron Standards and Automatic Flushing Tank. Cut shows water in motion.

Sections for	Length, over all	Weight, crated, lbs.	Shipping meas., cu. ft.	Painted		Enameled	
				Code	Price	Code	Price
2 Persons	5 ft. 4 in.	210	8 $\frac{3}{4}$	Padiglio	\$50.00	Paedaret	\$ 65.00
3 "	7 " 7 "	290	11 $\frac{2}{3}$	Padisha	60.00	Paedicate	80.00
4 "	9 " 9 "	315	14 $\frac{1}{2}$	Padouan	70.00	Paeminos	95.00
5 "	12 " 3 "	510	18 $\frac{3}{4}$	Padraste	78.00	Paenulati	110.00
6 "	14 " 5 "	600	21 $\frac{3}{4}$	Padrinaz	86.00	Paepsti	130.00
7 "	16 " 10 "	675	25	Padrino	120.00	Paestano	165.00
8 "	19 "	750	28	Padronal	130.00	Paffante	180.00
9 "	21 " 6 "	915	32	Padronness	138.00	Paffutos	195.00
10 "	24 "	1025	36	Paduaso	146.00	Pafone	210.00
11 "	26 " 2 "	1100	40	Padulesco	154.00	Pagadoir	230.00
12 "	28 " 4 "	1200	44	Paedago	162.00	Paganali	250.00

Above prices do not include woodwork.

Above weights are for painted closets, enameled closets 12 $\frac{1}{2}$ % heavier.

For ash seat as illustrated, add, per hole, \$3.50, weight 18 pounds.

For ash partitions between each basin, add, per hole, \$2.50, weight 25 pounds.

For the better class of work these closets may have partitions built between each basin, making separate compartments with doors arranged for each.

In Orders and Specifications give Plate Numbers.

WOLFF'S INDIVIDUAL BOWL SIPHON RANGE.

FOR SCHOOLS, FACTORIES, PUBLIC INSTITUTIONS, ETC.

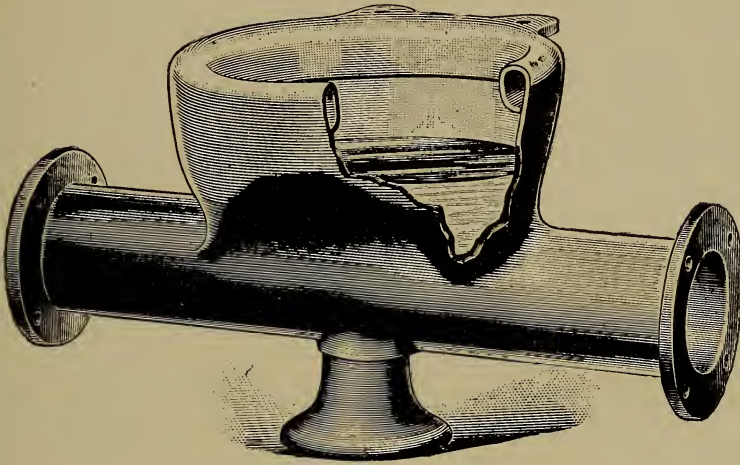

114-C.

Above sectional cut shows one section of Wolff's Individual Bowl Siphon Range, shown and listed on following page.

Each section, as shown above, is provided with a flushing rim cast integral with the Bowl; this flushing rim is connected to the Automatic Flushing Tank with a flush pipe, therefore, when tank operates and causes a thorough flushing of the Range, the flushing rims are also supplied with water flushing every part of the Bowl itself. Each bowl has a large water surface—a great advantage in any style of Range Closets.

Seats furnished with Wolff's Ranges are of heavy construction and fitted with heavy cast brass trimmings—an important feature in School Work where hard usage is liable.

To insure satisfactory results, Range must be **set level**. The **Air Pipe** must be carried **straight up** from the Trap to proper height as shown on following pages.

Height from floor to top of seat is 15 inches; 10-seat Double Ranges (five on a side) and less are furnished with 4-inch Traps, 12-seat Double Ranges (six on a side) and over, with 5-inch Traps.

Five-seat Single Ranges and less are furnished with 4-inch Traps, and six-seat Single Ranges and over, with 5-inch Traps.

Depth of water in each bowl ... inches. Depth of seal between bowls ... inches. Length of each section 24 or 27 inches.

Unless otherwise ordered, Ranges will be sent with **outlets on left hand end**, but when desired Ranges can be furnished with the Outlets on Right Hand End.

When Ranges are set up in exposed places and there is a liability of freezing, we would suggest, in order to obviate the danger as much as possible, that the Tanks, Flush Pipes, Bowls and Upper Trap be drained when not in use, or during vacation. For this purpose we provide a drain valve for the Tank and a drain Valve for the upper Trap. The drain Valve of **Upper Trap** should be connected with the Lower Trap by the plumber. Upon opening the valve, all the water in Upper Trap will be emptied into the Lower Trap.

We would further suggest that in localities of this kind, the Lower Trap be connected to the Upper Trap by a length of Soil Pipe, bringing the Lower Trap below the frost line.

In Orders and Specifications give Plate Numbers.

INDIVIDUAL BOWL SIPHON RANGE.



115-C.

The above cut represents Wolff's Individual Bowl Siphon Range with Flushing Rims, Cast Iron Flush Pipes, Oak Seats with Heavy Brass Hinges, and Copper Lined Automatic Patent Flushing Tanks and Upper and Lower Traps, as shown.

NOTE: See page 61 for full description of above Siphon Range.

Air Pipe from Tank to Trap is not included in list prices.

Number of Seats.	Shipping Weight, Lbs.	With 24-inch Seats, as described.				With 27-inch Seats, as described.			
		Code.	Painted.	Code.	Enameled.	Code.	Painted.	Code.	Enameled.
3	225	Paganize	\$ 82.25	Pagotine	\$ 94.25	Pajeabamo	\$ 84.75	Palabrad	\$ 99.00
4	300	Pagasico	97.50	Pagurian	112.75	Pajecillo	100.75	Palabrota	116.50
5	375	Pageant	112.50	Paguridal	131.25	Pajonism	116.50	Palabunt	135.25
6	495	Pagellar	128.75	Paideutic	151.00	Pajoniste	133.75	Palacious	155.75
7	577	Pagenstan	144.00	Pailebot	169.25	Pakarade	150.50	Palacrani	175.75
8	660	Paggerias	159.25	Paillard	188.00	Paketbote	166.75	Paladare	195.50
9	742	Paginante	174.75	Paillasso	207.00	Pakgaret	182.50	Paladeamo	214.75
10	825	Paginetto	190.50	Painelam	226.00	Pakkeld	199.00	Paladiale	234.50
11	908	Pagliett	206.25	Painstake	245.00	Pakkiste	215.75	Palafitt	254.50
12	990	Pagliuz	222.25	Pajanel	264.50	Paktolo	232.00	Palafren	274.25
13	1072	Pagmente	238.00	Pajarear	283.50				
14	1155	Pagnone	253.75	Pajarille	302.50				
15	1238	Pagodice	269.50	Pajazas	321.50				

For Galvanized Ring under Seat, add \$1.50 for each Seat.

Height from floor to top of seat is 15 inches; 5-seat Ranges and less are furnished with 4-inch Traps, 6-seat Ranges and over with 5-inch Traps.

Unless otherwise ordered, Ranges will be sent as shown, viz.: with **outlet on left hand end**, but when desired Ranges can be furnished with Outlet on Right Hand End.

Cast Iron Partitions and Backs can be furnished for above Ranges.

For Painted Cast Iron Partitions, add \$6.00 for each Partition.

For Galvanized Cast Iron Partitions, add \$10.00 for each Partition.

For Painted Cast Iron Backs, add \$6.75 for each Back.

For Galvanized Cast Iron Backs, add \$11.25 for each Back.

Weight of each Partition, 100 lbs. Weight of each Back, 24-inch, 100 lbs.; 27-inch, 150 lbs.

In Orders and Specifications give Plate Numbers.

INDIVIDUAL BOWL SIPHON CLOSET RANGE.

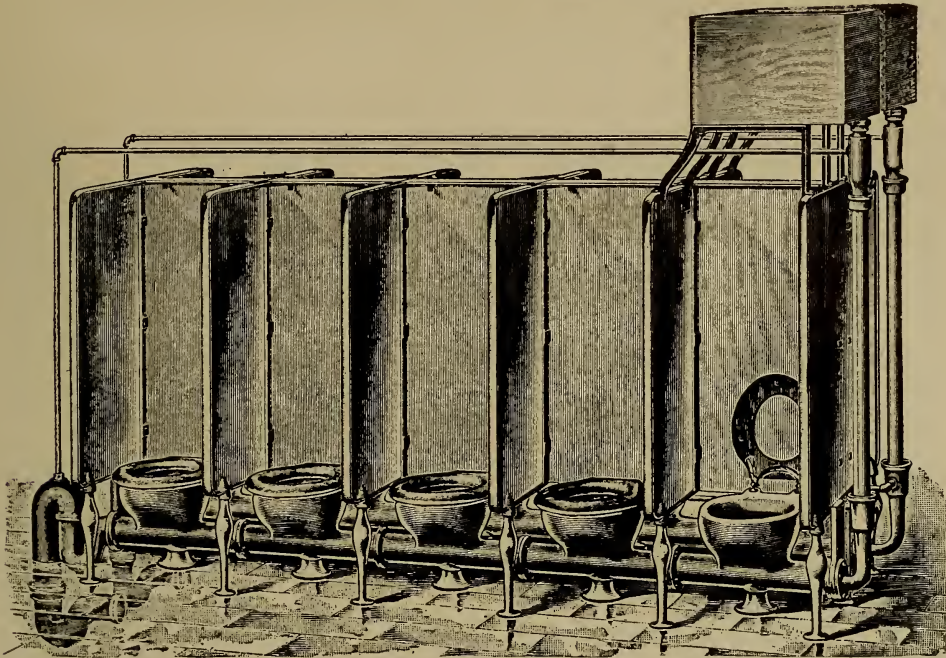

16-C.

The above cut represents Wolf's Individual Bowl Siphon Range with Flushing Rims, Cast Iron Flush Pipes, Oak Seats with Heavy Brass Hinges, Painted Cast Iron Partitions and Backs and Copper Lined Automatic Patent Flushing Tanks and Upper and Lower Traps, as shown.

Note:—See page 61 for full description of above Siphon Range.
Air Pipes from Tanks to Traps are not included in list prices.

Number of Seats.	Shipping Weight, Lbs.	With 24-inch Seats, complete as described.			
		Code.	Painted.	Code.	Enameled.
6 Seats, 8 Partitions, 3 Backs, as shown.	1550	Palamedeo	\$242.00	Palardeau	\$266.00
8 " 10 " 4 " "	2000	Palamitare	294.00	Palastdam	324.50
10 " 12 " 5 " "	2450	Palampor	345.50	Palatharus	383.00
12 " 14 " 6 " "	2970	Palancam	399.50	Palaver	444.00
14 " 16 " 7 " "	3420	Palanche	451.50	Palazzin	502.00
16 " 18 " 8 " "	3870	Palandre	503.50	Palazziste	561.00
18 " 20 " 9 " "	4320	Palanquet	560.50	Palchetto	624.50
20 " 22 " 10 " "	4770	Palanquin	614.00	Palcador	685.00
22 " 24 " 11 " "	5220	Palantibo	667.50	Paleness	745.25
24 " 26 " 12 " "	5670	Palaptery	721.25	Paleograf	805.75

Number of Seats.	Shipping Weight, Lbs.	With 27-inch Seats, complete as described.			
		Code.	Painted.	Code.	Enameled.
6 Seats, 8 Partitions, 3 Backs, as shown.	1700	Palermite	\$250.00	Palicote	\$278.50
8 " 10 " 4 " "	2200	Palesano	304.50	Palikare	335.00
10 " 12 " 5 " "	2700	Palesator	358.50	Palimpest	396.00
12 " 14 " 6 " "	3320	Palestino	415.50	Palindrom	459.50
14 " 16 " 7 " "	3940	Paletation	471.50	Palinloge	522.00
16 " 18 " 8 " "	4560	Paletoque	526.50	Palinodia	584.00
18 " 20 " 9 " "	5180	Palfurio	582.50	Palinodist	646.75
20 " 22 " 10 " "	5800	Palhares	638.25	Paiissage	709.00
22 " 24 " 11 " "	6420	Paliativa	694.25	Palisson	771.75
24 " 26 " 12 " "	7040	Paliboth	750.00	Palitabor	834.00

For Galvanized Ring under Seat, add \$1.50 for each Seat.

For Galvanizing Partitions, add \$4.00 for each Partition.

For Galvanizing Backs, add \$4.50 for each Back.

Height from floor to top of Seat is 15 inches; 10-Seat Ranges (five on a side) and less are furnished with 4-inch Traps, 12-Seat Ranges (six on a side) and over with 5-inch Traps.

Unless otherwise ordered, Ranges will be sent as shown, viz.: with **Outlet on Left Hand End**, but when desired, Ranges can be furnished with the Outlets on Right Hand End.

In Orders and Specifications give Plate Numbers.

AUTOMATIC "BRIGHTON" OPEN SIPHON RANGE CLOSET.

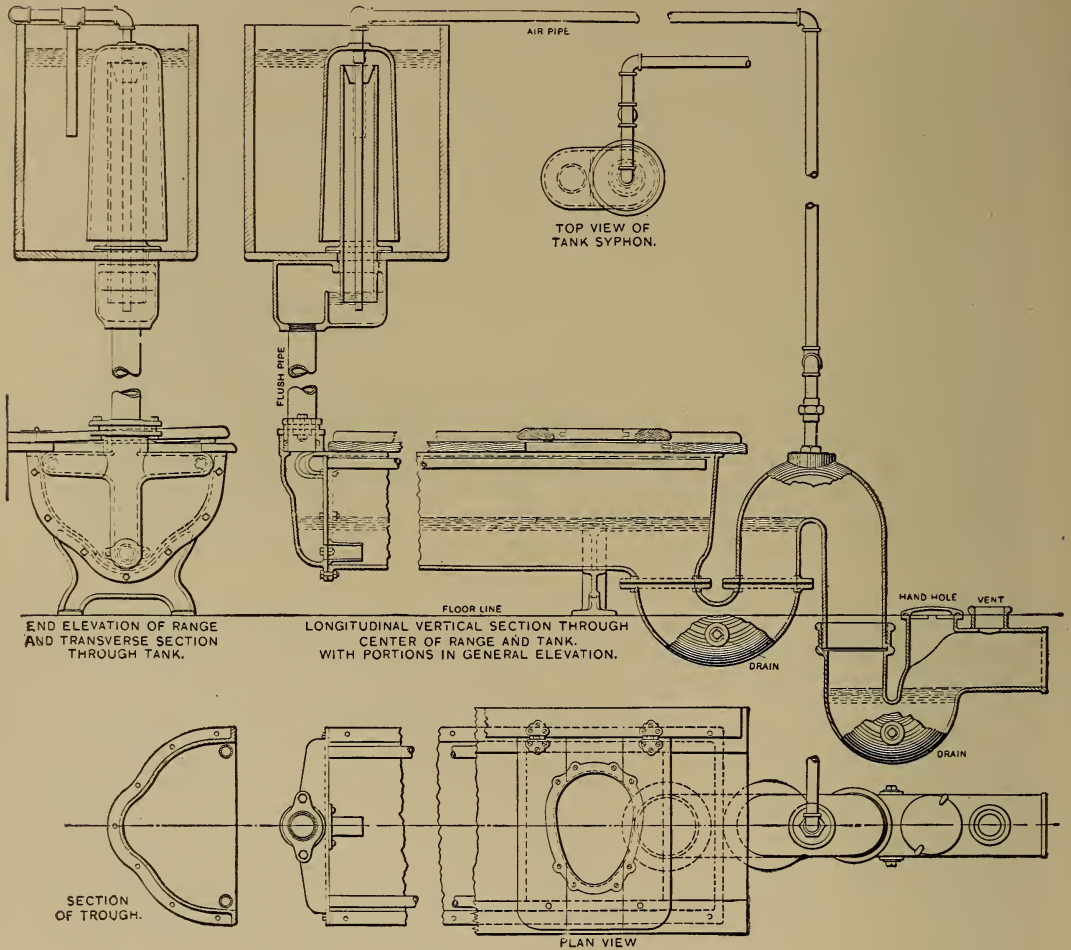

118-C.

An accurate knowledge of the relative position of parts will be gained by reference to the above drawings.

Full instructions for erecting and operating are furnished with each fixture.

Blue prints giving detailed dimensions of every part of complete Range, and all information essential to "roughing-in," will be sent on request.

Approximate Weight Crated of "Brighton" Open Range Closet with 24-inch Seats, As Shown in 120-C.

No. of Seats.....	3	4	5	6	7	8	9	10	11	12	13	14	15
Tank, lbs.....	80	80	100	110	140	160	175	180	190	195	200	220	230
Trough, Seat, Frame and Legs, lbs..	300	400	500	600	700	800	900	1000	1100	1200	1300	1400	1500
Trap, lbs.....	150	150	150	150	150	150	150	150	150	150	150	150	150
Fittings, lbs.....	175	175	175	175	175	175	175	175	175	175	175	175	175
Total, lbs.....	705	805	925	1055	1165	1285	1400	1505	1615	1720	1825	1945	2055

Partitions, 125 lbs.; 24-inch backs, 110 lbs.; 27-inch backs, 120 lbs.

In Orders and Specifications give Plate Numbers.

AUTOMATIC "BRIGHTON" OPEN SIPHON RANGE CLOSET.

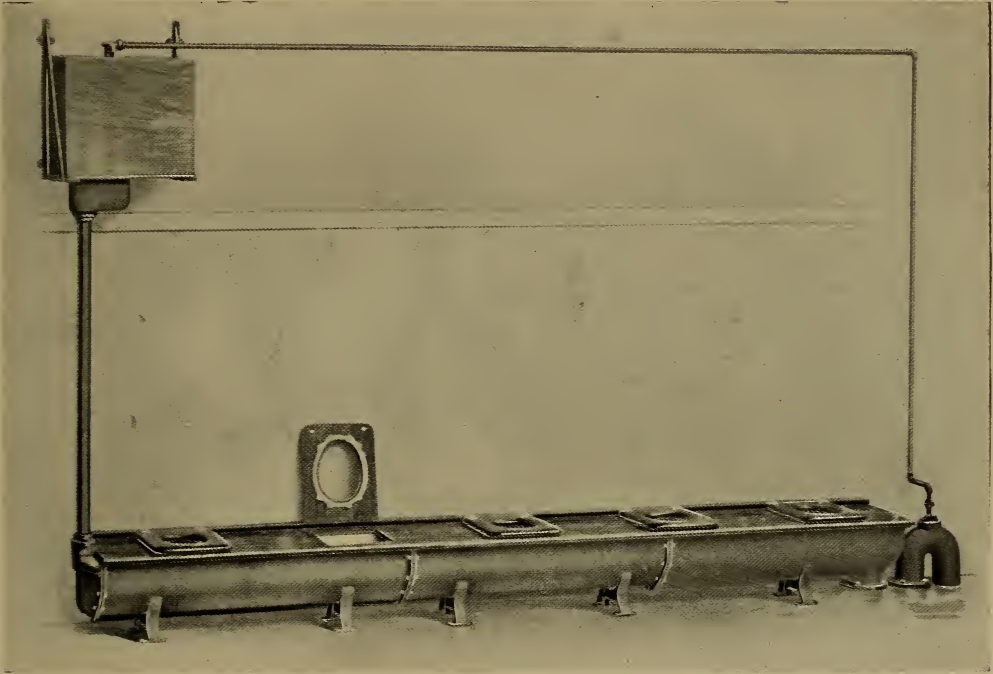

120-C.

With Siphon Education Copper-Lined Wood Tank, Galvanized Iron Flush Pipe, Hinged Oak Seats with Iron Reinforcements, Oak Top Plate and Back Strip. Perforated Wash-Down Pipes fitted inside of Range (Brass on Enameled and Galvanized Iron on Painted Ranges).

No. of Seats.	24-Inch Seats.		24-Inch Seats.		27-Inch Seats.		27-Inch Seats.	
	Code.	Painted.	Code.	Enameled.	Code.	Painted.	Code.	Enameled.
2	Pallacar	\$ 64.25	Pallottini	\$ 75.75	Palmigrad	\$ 66.25	Palmzond	\$ 78.75
3	Pallacines	74.75	Palmaceo	89.50	Palmipor	77.75	Palmzuck	94.00
4	Palladore	85.25	Palmadill	103.50	Palmister	89.25	Palombin	109.25
5	Pallakopa	98.75	Palmate	120.25	Palmkolbe	104.25	Palomilla	127.75
6	Pallasemo	112.25	Palmavist	137.00	Palmmark	118.25	Palotada	145.50
7	Pallatina	126.00	Palmbaum	153.75	Palmoped	132.75	Paloteos	163.75
8	Pallatores	138.25	Palmbohr	169.25	Palmotead	146.50	Paloteur	181.25
9	Pallafact	150.25	Palmella	184.75	Palmoule	161.25	Palpabile	199.75
10	Pallescun	163.50	Palmentos	201.25	Palmsap	175.50	Palpades	217.25
11	Palliate	176.50	Palmesana	217.25	Palmspier	190.00	Palpadora	235.50
12	Pallidette	189.50	Palmesell	233.75	Palmstock	204.50	Palpament	253.75
13	Pallidore	203.50	Palmetazo	251.00	Palmule	219.25	Palpamina	272.25
14	Pallodes	216.75	Palmhout	267.50				
15	Palloribus	230.25	Palmicorn	284.50				

If Seat Covers are wanted, add \$1.00 each.

Painted Cast Iron Tanks can be furnished if desired without extra charge.

Lead-Lined Tanks can be furnished to order. (Prices on application.)

The above arrangement is such that carpenter may put in wood partition if desired.

Unless otherwise ordered, Range with Enameled Interior, 24 inch Seats and Outlet on right end, as shown, will be sent.

Sectional views of Range are shown on page 64.

In Orders and Specifications give Plate Numbers.

AUTOMATIC "BRIGHTON" OPEN SIPHON RANGE CLOSET.

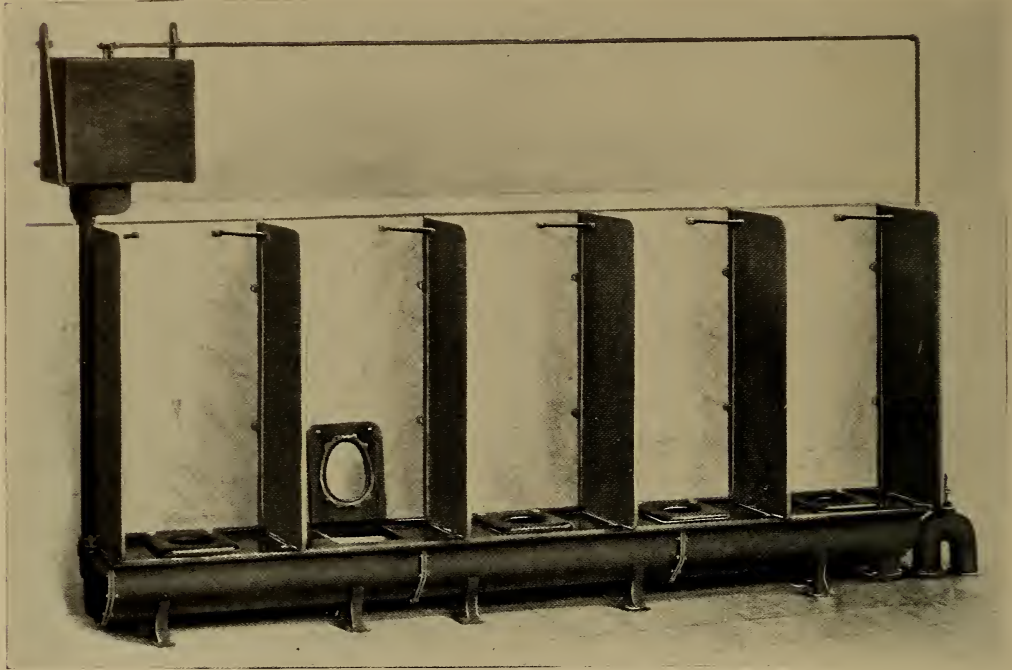

120½-C.

With Siphon Eduction Copper-Lined Wood Tank; Galvanized Iron Flush Pipe; Hinged Oak Seats with Iron Reinforcements; Oak Top Plate and Back Strip, and Painted Iron Partitions. Perforated Wash-Down Pipes fitted inside of Range (Brass on Enameled and Galvanized Iron on Painted Ranges).

No. of Seats.	24-Inch Seats.		24-Inch Seats.		27-Inch Seats.		27-Inch Seats.	
	Code.	Painted.	Code.	Enameled.	Code.	Painted.	Code.	Enameled.
2	Palpamise	\$ 83.75	Palpaness.....	\$ 95.25	Palpapacy....	\$ 85.75	Palpapilla.....	\$ 98.25
3	Palpamity....	100.75	Palpanffia	115.50	Palpapada ...	103.75	Palpapion.....	120.00
4	Palpamobur..	117.75	Palpanges.....	136.00	Palpapal	121.75	Palpapoter ...	141.75
5	Palpamocca..	137.75	Palpangon ...	159.25	Palpaparia ...	143.25	Palpapou.....	166.75
6	Palpamodess	157.75	Palpanit.....	182.50	Palpapasso...	163.75	Palpapoula ...	191.00
7	Palpamoll....	178.00	Palpanitre ...	205.75	Palpapanti ...	184.75	Palpapyro.....	215.75
8	Palpamote ...	196.75	Palpanjata ...	227.75	Palpaparel ...	205.00	Palpapyrus...	239.75
9	Palpamour ...	215.25	Palpanlela....	249.75	Palpapegat...	226.25	Palpaqueto...	264.75
10	Palpamuba...	235.00	Palpanlell....	272.75	Palpapelao ...	247.00	Palpaquife...	288.75
11	Palpamutte...	254.50	Palpanlian ...	295.25	Palpapelon...	268.00	Palpaquons...	313.50
12	Palpan	274.00	Palpanlios...	318.25	Palpapesco...	289.00	Palpaquote...	338.25
13	Palpanage....	294.50	Palpanlizo...	342.00	Palpapier.....	310.25	Palpaquox....	363.25
14	Palpandola ...	314.25	Palpanlume..	365.00				
15	Palpanenope	334.25	Palpanlyse ...	388.50				

If Seat Covers are wanted, add \$1.00 each.

If with Painted Cast Iron Backs, add to 24-inch Seat Range \$6.50 for each Back; 27-inch Seat Range, \$7.50 for each Back.

Painted Cast Iron Tanks can be furnished, if desired, without extra charge. Lead-Lined Tank can be furnished to order. (Prices on application.)

Unless otherwise ordered, Range with Enameled Interior, 24-inch Seats and Outlet on right end, as shown, will be sent.

Sectional views of Range are shown on page 64.

In Orders and Specifications give Plate Numbers.

AUTOMATIC "BRIGHTON" OPEN SIPHON DOUBLE RANGE CLOSET.

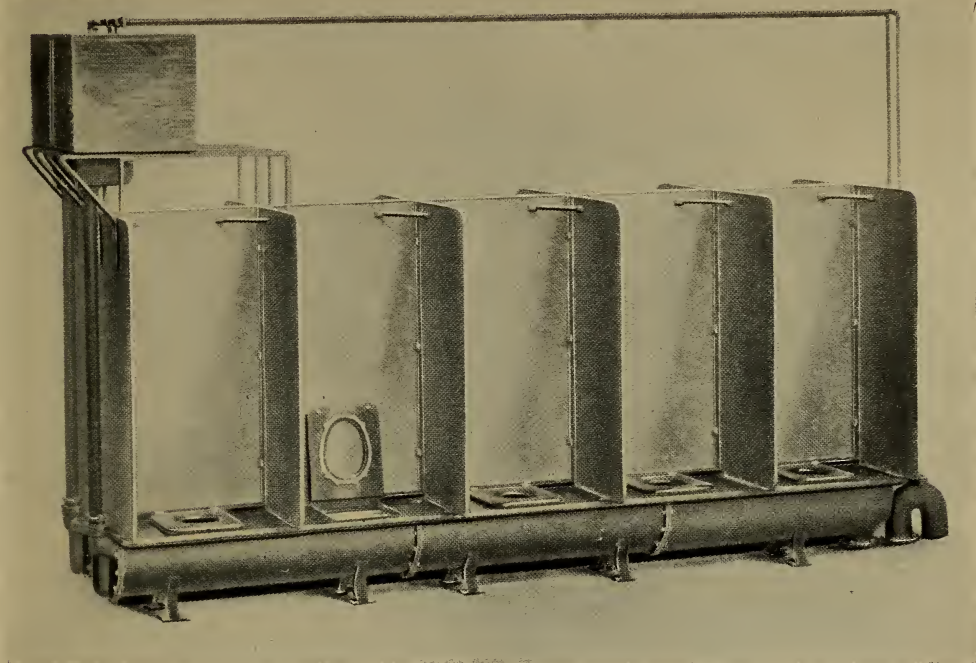

121-C.

With Siphon Education Copper-Lined Wood Tanks; Galvanized Iron Flush Pipes; Hinged Oak Seats with Iron Reinforcements; Oak Top Plates and Back Strips and Painted Iron Partitions and Backs; Perforated Wash-Down Pipes fitted Inside of Ranges (Brass on Enameled and Galvanized Iron on Painted Ranges).

No. of Seats.	24-Inch Seats.		24-Inch Seats.		27-Inch Seats.		27-Inch Seats.	
	Code.	Painted.	Code.	Enameled.	Code.	Painted.	Code.	Enameled.
4	Palparla	\$182.50	Palpitant	\$205.50	Paltiel	\$188.50	Paludige	\$213.50
6	Palpativo	224.00	Palpitaro	253.50	Paltonate	233.00	Paludiva	265.50
8	Palpatore	265.50	Palpitone	302.00	Paltoquet	277.50	Paludosas	317.50
10	Palpavel	313.00	Palponis	356.00	Paltram	329.00	Palumbino	376.00
12	Palpebra	360.50	Palporum	410.00	Paltrily	378.50	Palumbos	433.00
14	Palperiez	408.50	Palrador	464.00	Paludano	429.00	Palumbuli	491.00
16	Palpeur	453.50	Palratori	515.50	Paludatos	478.00	Palurdes	547.50
18	Palpifera	498.00	Palsgrave	567.00	Palude	529.00	Palustral	606.00
20	Palpiform	545.00	Palsical	620.50	Paludello	579.00	Pambores	662.50
22	Palpimane	591.50	Palster	673.00	Paludicas	629.50	Pamfilio	720.50
24	Palpitado	638.00	Paltata	726.50	Paludier	680.00	Pamisos	778.50

If Seat Covers are wanted, add \$1.00 each.

Painted Cast Iron Tanks can be furnished, if desired, without extra charge. Lead-Lined Tanks, can be furnished to order. (Prices on application.)

Width of above Double Range and Partitions, as shown, 52 inches. From center to center of Outlets 22 inches.

Unless otherwise ordered, Ranges with Enameled Interior, 24-inch Seats and Outlets on right end, as shown, will be sent.

Sectional views of Range are shown on page 64.

In Orders and Specifications give Plate Numbers.

“NEPTUNE” MARINE PUMP WATER CLOSET.

(Howell's Patent)

For Battleships, Rams, Monitors, Cruisers, Yachts and all other vessels which require the placing of their water closets either below the water line or at so slight an elevation above it as to necessitate the use of a pump to eject the contents.

Handsome in appearance, durable of construction and possessing features which are entirely novel and of such importance as to recommend the closet at once to all who are interested in modern naval architecture.

It is controlled entirely by one lever; there are no pulls or foot treadles to be operated before water can enter bowl.

An overflow is impossible; in addition to the usual safeguards provided in this type of Water Closet, the “Neptune” possesses one very important advantage—the supply valve cannot be opened except by operating the lever which controls the discharge pump, therefore, to overflow the bowl either designedly, by accident or by inadvertently holding the supply valve open too long (which may occur in all other pump closets), is impossible with the “Neptune.”

The bowl can never be left without standing water, which is accumulated in the refill chamber during the act of pumping out the closet. As this chamber retains the exact amount of water required to refill the bowl, it can never be overcharged.

No special instruction is required to operate the “Neptune.” From eight to ten full strokes of the lever are usually sufficient to eject the contents of bowl and will always provide the necessary refill.

The “Neptune” will work satisfactorily in any location, either above the water line; the supply pipe may be carried out board, connected with a tank, or water may be lifted should the closet be located above the source of supply.

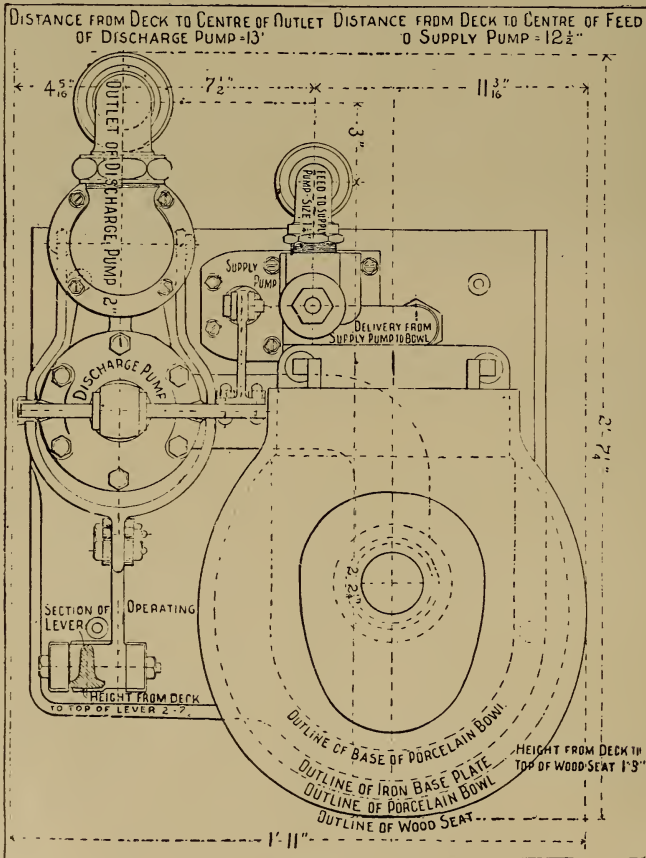

122-C.

Plan and Dimensions of “Neptune” Water Closet.

Length over all, 23 inches; depth from front of seat to back of discharge coupling, 31¼ inches; height from deck to top of seat, 17 inches; height from deck to end of lever, 31½ inches; supply pipe, 1¼ inches; discharge pipe, 2 inches.

Accompanying cut shows Left Hand Closet.

Closet may be furnished with discharge pump and lever on right hand side of closet, if so desired. Left Hand Closet will always be furnished unless otherwise ordered.

In Orders and Specifications give Plate Numbers.

“NEPTUNE” MARINE PUMP WATER CLOSET.

(Howell's Patent)

ONE LEVER DOES THE WORK.

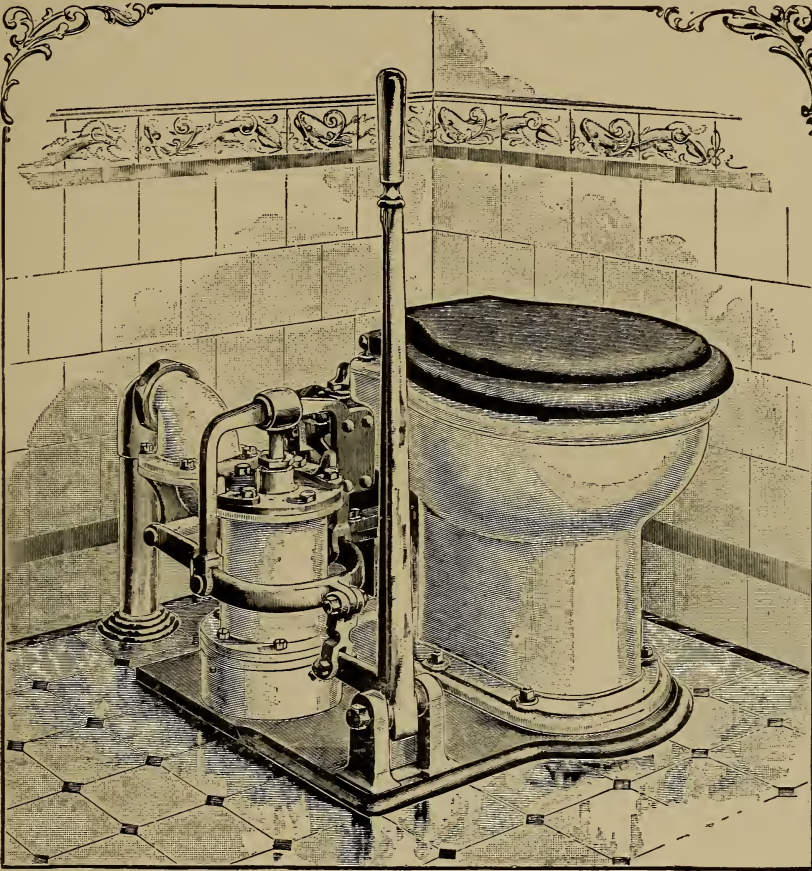

123-C.

“Neptune” Water Closet with Galvanized Iron Base-Plate, American Vitreous Porcelain pedestal Bowl, highly finished Mahogany Seat and Cover attached to bowl, Brass combined Supply Pump and Inlet Valve, and Discharge Pump finished in fine white enamel; Bent Supply and Discharge Couplings, Brass Lever and other trimmings nickel-plated.

Code.....	Pamoisir
Price as described	\$162.00
Shipping weight, lbs.....

The “Neptune” Closet can be furnished to order as follows:

With heavily Silver-Plated trimmings, \$25.00 extra.

With Bowl decorated with burnished gold bands, \$10.00 extra.

With Quartered Oak seat, same price as Mahogany.

With discharge Pump and Lever on right hand side, same price as above.

With straight Supply and Discharge Couplings, same price as bent.

In Orders and Specifications give Plate Numbers.

“NEPTUNE JR.” MARINE PUMP WATER CLOSET.

(Howell's Patent)

The great success attending the introduction of the “Neptune” Water Closet has led to the construction of a smaller closet, the “Neptune Jr.,” which is designed for yachts, torpedo boats and small craft where space is too limited to receive the regular “Neptune” Closet.

The “Neptune Jr.” differs from the “Neptune” in size only, in other respects the two closets are identical.

NOTE: See page 68 for description.

Plans and Dimensions of “Neptune Jr.” Water Closet:

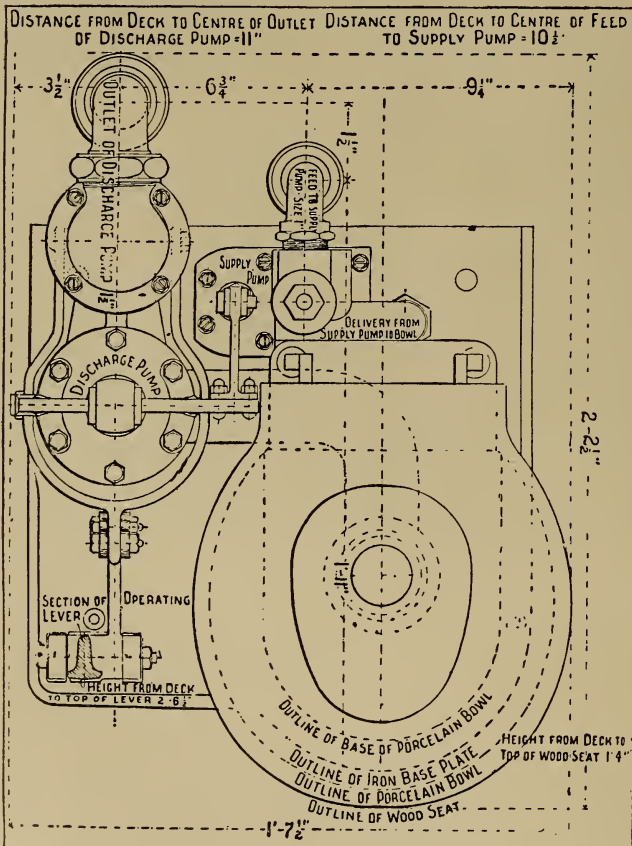

124-C.

Length over all, 19 1/2 inches; depth from front of seat to back of discharge coupling, 26 1/2 inches; height from deck to top of seat, 16 inches; deck to end of lever, 30 1/2 inches; supply pipe, 1 inch; discharge pipe, 1 1/2 inches.

In Orders and Specifications give Plate Numbers.

"NEPTUNE JR." MARINE PUMP WATER CLOSET.

(Howell's Patent)

SMALL PATTERN "NEPTUNE" CLOSET FOR YACHTS AND OTHER CRAFT.

ONE LEVER DOES THE WORK.

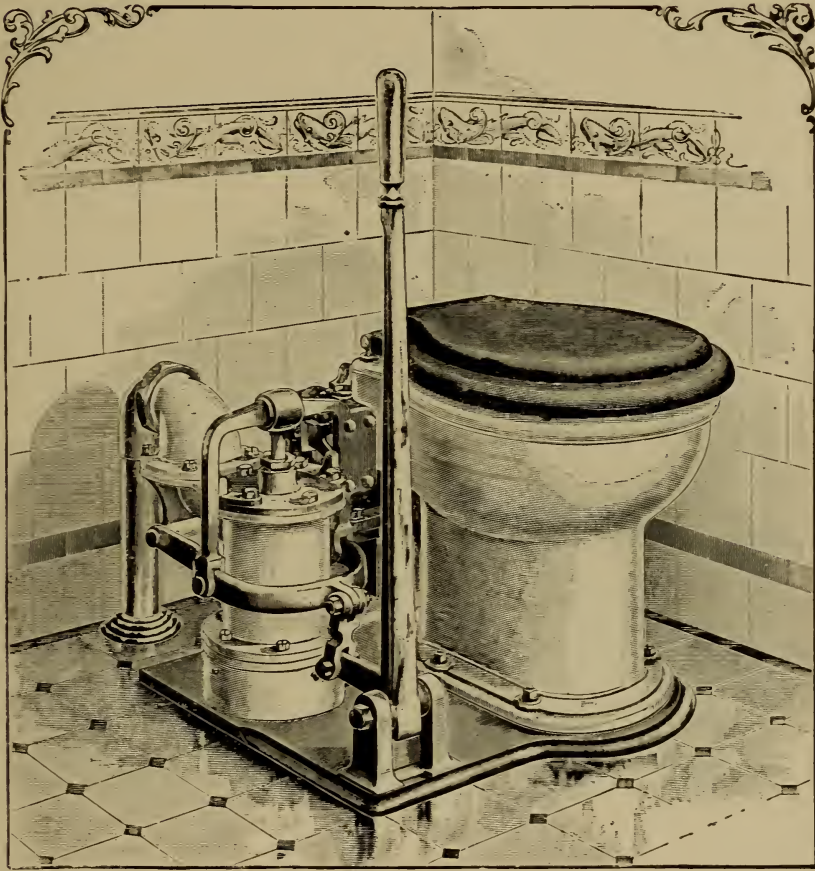

125-C.

The "Neptune Jr." Water Closet with Galvanized Iron Base-Plate, American Vitreous Porcelain Pedestal Bowl, highly finished Mahogany Seat and Cover attached to bowl, Brass Combined Supply Pump and Inlet Valve, and Discharge Pump finished in fine white enamel; bent Brass Supply and Discharge Couplings, Brass Lever and other trimmings nickel-plated.

Code.....	Pampanás
Price complete as described.....	\$150.00
Shipping weight, lbs.....

The "Neptune Jr." Closet can be furnished to order as follows :

With heavily Silver-Plated Trimmings, \$20.00 extra.

With bowl decorated with burnished gold bands, \$10.00 extra.

With Quartered Oak Seat and Cover, same price as Mahogany.

With straight Supply and Discharge Couplings, same price as bent.

With Discharge Pump and Lever on right hand side, same price as above.

In Orders and Specifications give Plate Numbers.

“COLUMBIA” PEDESTAL SHIP WATER CLOSET.

(Patented.)

SINGLE VALVE.



126-C.

The “Columbia” Water Closet, with Galvanized Iron Base-plate, American Vitreous Porcelain Pedestal Bowl; highly finished Mahogany Seat and Cover attached to bowl; Porcelain Enamelled Pull Post, heavy cast Brass Valve Box and Operating Mechanism and 1½-inch Brass Supply Valve; all exposed Brass Trimmings Nickel-Plated except Seat Hinges and Pull Post Fittings, which are heavily Silver-Plated.

Code	Pamparigo
Price complete as described	\$118.50
Shipping weight, lbs.....	294

Dimensions:

Height from deck to top of seat, 19½ inches; width from side to side, 22 inches, depth from front of seat to bulkhead back of closet, 28 inches; distance from center of outlet to bulkhead back of closet, 16 inches.

The “Columbia” Water Closet is in successful operation on vessels of the United States Navy, also on the International Navigation Company’s steamers.

In Orders and Specifications give Plate Numbers.

"PACIFIC" PEDESTAL SHIP WATER CLOSET.

(Patented.)

SINGLE VALVE.

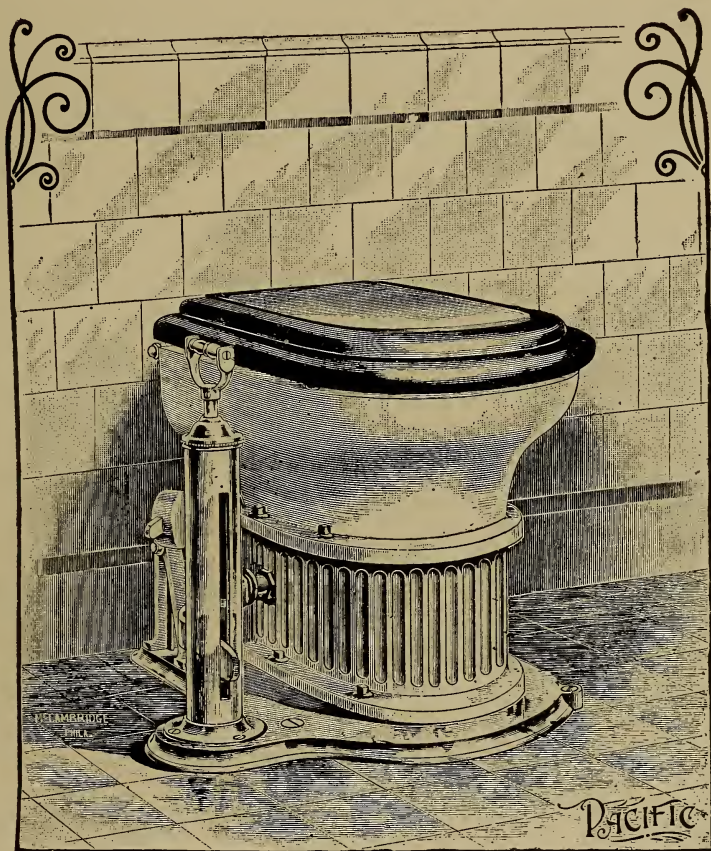

127-C.

The "Pacific" Water Closet with Galvanized Iron Base-Plate, American Vitreous Porcelain bowl with Enameled Iron Pedestal, highly finished Mahogany Seat and Cover attached to bowl, Porcelain Enameled Pull Post, heavy cast Galvanized Iron Valve Box, heavy cast brass operating mechanism and 1½-inch brass supply valve; all exposed brass trimmings are nickel-plated.

Code.....	Pamperize
Price complete as described.....	\$86.50
Shipping weight, lbs.....

The "Pacific" Water Closet is constructed upon the same general plan as the "Columbia."

Dimensions :

Height from deck to top of seat, 19½ inches; width from side to side, 22 inches; depth from front of seat to bulkhead back of closet, 28 inches; distance from center of outlet to bulkhead back of closet, 16 inches.

In Orders and Specifications give Plate Numbers.

“ATLANTIC” SHIP WATER CLOSET.

(Patented.)

SINGLE VALVE.

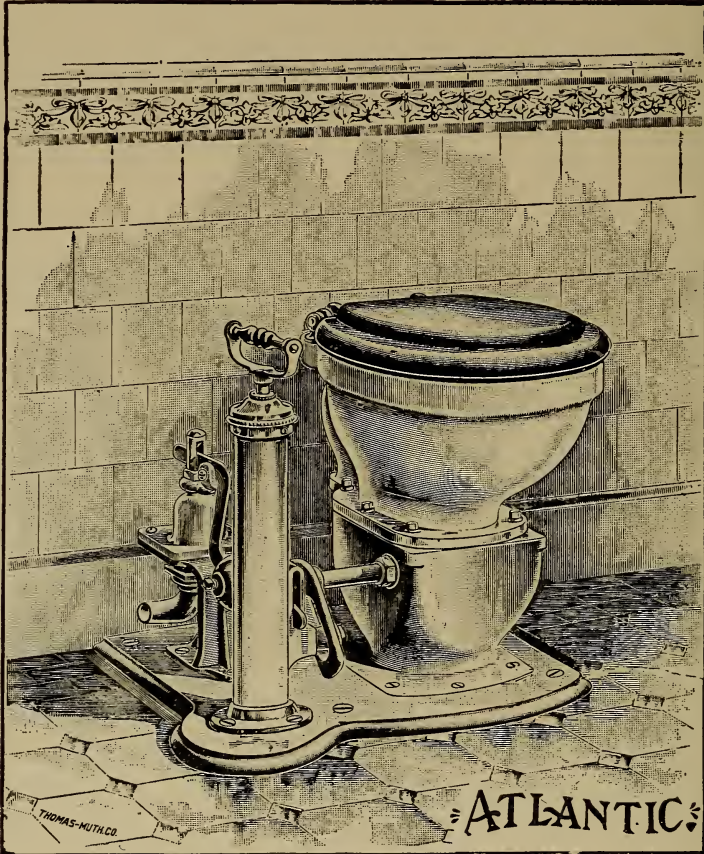

128-C.

The “Atlantic” Water Closet with Galvanized Iron Base-Plate; American Vitreous Porcelain Bowl with flushing and re-fill Rim, highly finished Mahogany Seat and Cover attached to bowl; Enamelled Iron Pull Post with Brass Cap and Stirrup Handle and Cast Brass Valve Box, Supply Valve and operating mechanism; all exposed brass trimmings are nickel-plated.

Code	Pamphilus
Price complete as described.....	\$68.50
Shipping weight, lbs.....	233

The “Atlantic” is a high class ship water closet of moderate cost; attractive in appearance, perfect in operation and thoroughly well made in every detail.

Dimensions:

Height from deck to top of seat 18½ inches; width from side to side, 20 inches; depth from front of seat to back of closet, 22 inches; distance from center of outlet to back of closet, 12 inches.

In Orders and Specifications give Plate Numbers.

†“**DELAWARE**” SHIP WATER CLOSET.

(Patented.)

SINGLE VALVE.

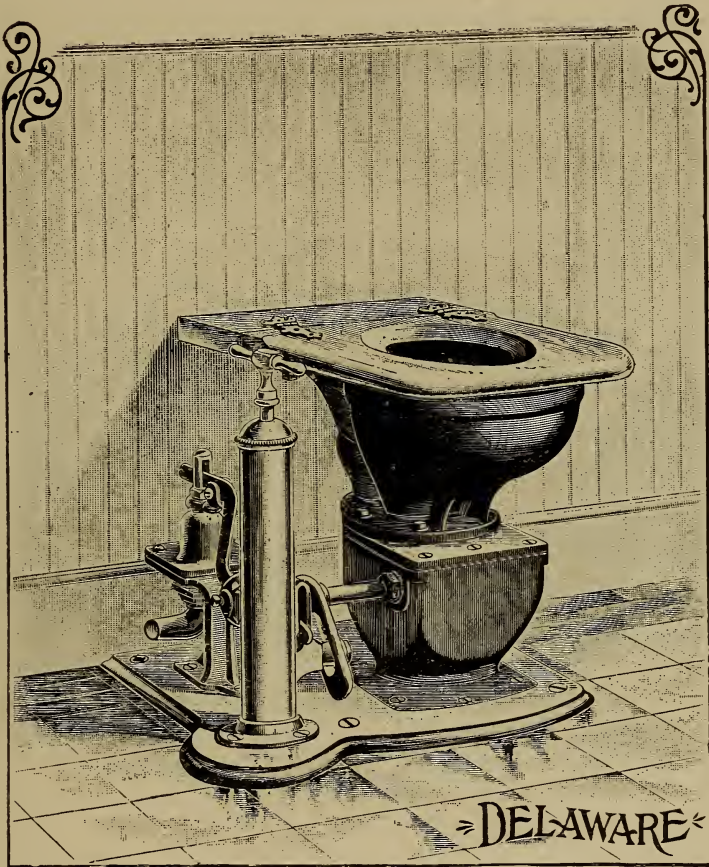

129-C.

The “Delaware” Water Closet with Galvanized Iron Base-Plate, Porcelain Lined Iron Bowl with Oak Seat attached, Galvanized Iron Pull Post and Valve Box, Brass Supply and Outlet Valves, and brass trimmings.

Code.....	Pampilon
Price complete as described.....	\$46.00
Shipping weight, lbs.....

Owing to the great durability of its construction, the “Delaware” is especially adapted for use as a crew water closet.

Dimensions :

Height from deck to top of seat, 18½ inches; width from side to side, 21 inches; depth from front of seat to back of closet, 24 inches.

†Carried in San Francisco only.

In Orders and Specifications give Plate Numbers.

†“SAND’S” PUMP WATER CLOSET.

(Sand’s Patent)

FOR YACHTS, LAUNCHES, NAVAL VESSELS, ETC., ABOVE OR BELOW WATER LINE.



131-C.

“Sand’s” Pump Water Closet with Galvanized Iron Base-Plate, Oval Embossed Flushing Rim, Vitreous Porcelain Bowl, highly finished Oak Seat and Cover attached to bowl with Nickel-Plated Brass Hinges, Brass Pump and Valve, Improved Foot Valve, Polished Brass Brake with Hardwood Handle.

Code.....	Pampineo
Price as described.....	\$80.00
Shipping weight, lbs.....	200
Shipping measurement, cubic feet.....	6

Dimensions:

Height from deck to top of seat, 19 inches; width from side to side, 22 inches; depth from front of seat to bulkhead back of closet, 19 inches; from end of outlet coupling to deck, 7 inches; from center of supply coupling to deck, 2½ inches; Supply Connection, ¾ inch; Discharge Connection, 1½ inches.

The improved Foot Valve used on all these closets is so constructed that it closes with the pressure, not against it. It has no spring to wear and become weak, no packing gland to leak, no joints to drip and will not get out of order.

Cut illustrates Right Hand Fixture, can be furnished either right or left hand. Left hand always sent unless otherwise directed.

†Carried in San Francisco only.

In Orders and Specifications give Plate Numbers.

†“DANDY” PUMP WATER CLOSET.

(Sand's Patent)

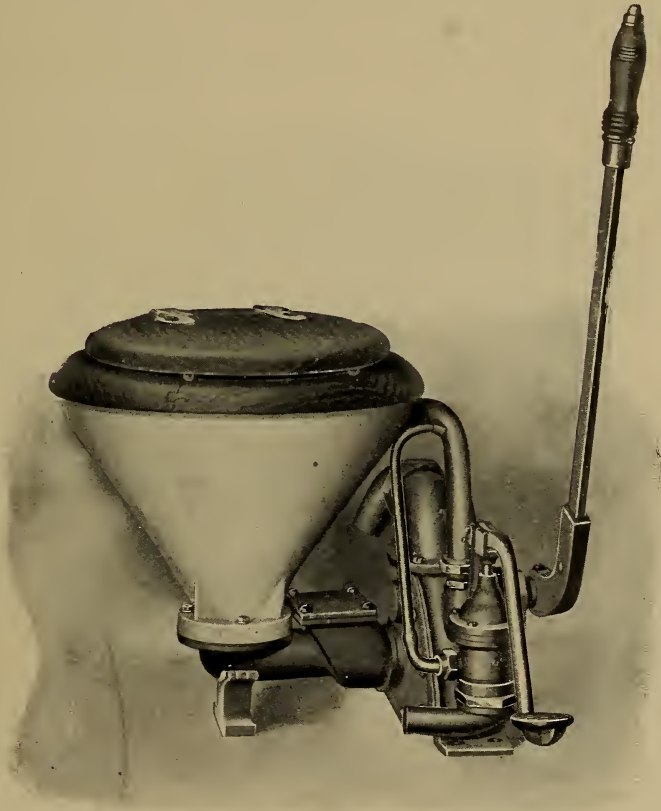

132-C.

Round Flushing Rim Porcelain Bowl, highly finished Oak Seat and Cover with heavy Nickel-Plated Brass Hinges attached to bowl, Composition Metal Pump and Connections, Improved Foot Valve, Brass Brake with Handle.

Code.....	Pamplina
Price as described.....	\$80.00
Shipping weight, lbs.....	160
Shipping measurement, cubic feet.....	4

Dimensions :

Height from base to top of seat, 14 inches; width from side to side, 21 inches; depth from front of seat to bulkhead back of closet, 15 inches. Supply Connection, $\frac{3}{4}$ inch. Discharge Connection, $1\frac{1}{2}$ inches.

Cut illustrates Right Hand Fixture, can be furnished either right or left hand. Left Hand Fixture always shipped unless otherwise directed.

†Carried in San Francisco only.

In Orders and Specifications give Plate Numbers.

†“**KNOCKABOUT**” **PUMP WATER CLOSET.**

(Sand’s Patent)

A SMALL FIXTURE, ADAPTED FOR USE IN YACHTS AND LAUNCHES.

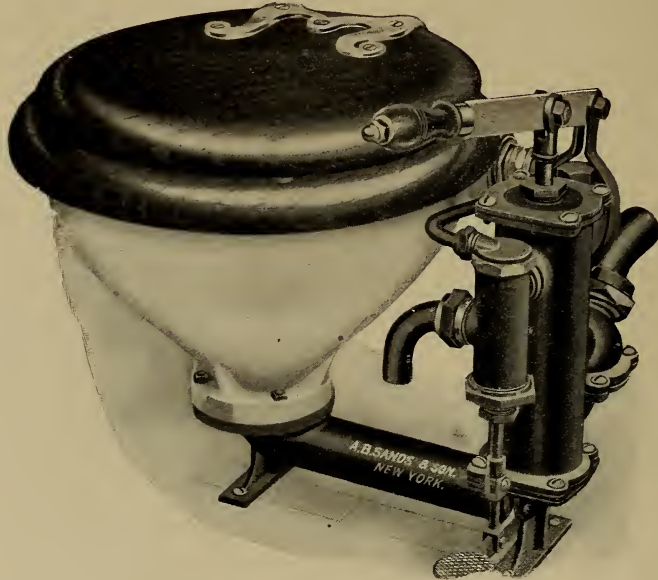

133-C.

Round Porcelain Flushing Rim Bowl; Oak Seat and Cover with Nickel-Plated Brass Hinges
All parts of Pump Composition Metal.

High grade in every particular. Where small or light weight closet is desired, this fixture is unsurpassed, combining all the practical sanitary features of the larger styles with economy in space, weight and price.

Code.....	Pamposto
Price complete as described.....	\$65.00
Shipping weight, lbs.....	75
Shipping measurement, cubic feet.....	3

For “Knockabout” Closet without seat, deduct \$12.00.

Dimensions:

Space occupied, 14x18 inches; Cylinder, 2½ inches diameter; height, to top of bowl, 11½ inches; to top of pump handle, 14 inches; Supply Connection, ¾ inch; Discharge Connection, 1½ inches.

Cut illustrates Right Hand Fixture, can be furnished right or left hand. Left Hand Fixture always shipped unless otherwise directed.

†Carried in San Francisco only.

In Orders and Specifications give Plate Numbers.

† H. M. & S. SHIP WATER CLOSET.

FOR USE ABOVE WATER LINE WITH SUPPLY FROM TANK OVERHEAD OR PRESSURE.

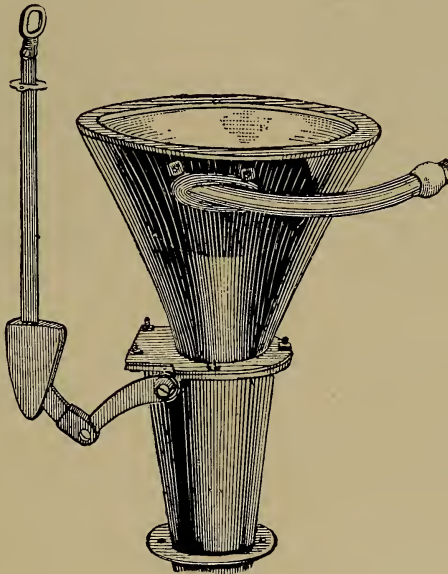

134-C.

Porcelain Fan Wash Lead Covered Bowl, Brass Clapper Valve with Stuffing Nut on Axle and Brass Valve Pull.

Code.....	Pampress
Price as described.....	\$20.00
Shipping weight, lbs.....	60
Shipping measurement, cubic feet.....	3

Dimensions:

Outside diameter of top, 14 inches; height from flange to top of bowl, $16\frac{1}{2}$ inches; Outlet, 4 inches; Supply, $\frac{3}{4}$ inch.

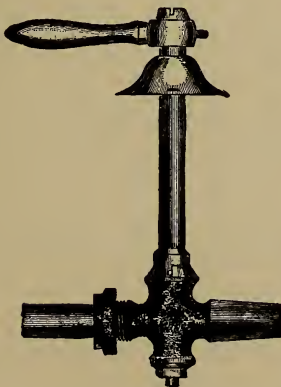

135-C.

† SHIP CLOSET COCK.

WITH COUPLING NUT AND TUBE.

$\frac{3}{4}$ -INCH. FOR LEAD PIPE.

Code.....	Panacar	Panache
Style	Fin. Hndl.	N. P. Hndl.
Per dozen	\$40.00	42.00
Weight per doz., lbs	18	18

One half dozen in a package.

† Carried in San Francisco only.

In Orders and Specifications give Plate Numbers.

“VITREOUS CHINA” CLOSET BOWLS.



140-C.

PLAIN SIPHON PINNACLE JET. CENTER
OUTLET. TOP INLET.

Code.....Panacino
With Seat Attachment and 1½-inch Spud \$18.00

Code.....Panacrat
With Seat Attachment and 2-inch Spud... \$18.00

Shipping weight, each crated, lbs..... 60
Shipping measurement, each crated, cubic feet..... 4



141-C.

EMBOSSED SIPHON PINNACLE JET. CENTER
OUTLET. TOP INLET.

Code.....Panadead
With Seat Attachment and 1½-inch Spud \$19.00

Code.....Panaggio
With Seat Attachment and 2-inch Spud... \$19.00

Roughing-in Measurement:

High Tank Combination, distance from face of finished wall to center of outlet, 11¼ inches.
Low Down Combination, distance from face of finished wall to center of outlet, 14¼ inches.

Drawings and Measurements of 140-C and 141-C.

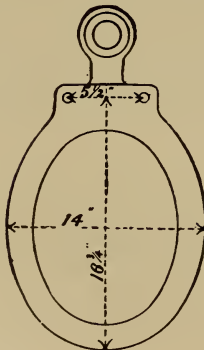

Diagram showing top of Bowl and giving measurements.



Diagram showing Base of Bowl and giving the closest measurement at which Bowl can be set.

These Bowls have double jet pipes, which make them a very strong, positive and quick-working Bowl. They have center outlet, and have the largest water area of any Siphon jet bowl on the market, the water surface measuring 11x13 inches.

Packed 12 in a crate. Approximate weight per crate, 650 pounds.

In Orders and Specifications give Plate Numbers.

“VITREOUS CHINA” CLOSET BOWLS.



148-C.

PLAIN WASH DOWN SIPHON. CENTER OUTLET.
WITH DEEP JET.

Code.....Panatella
With Seat Attachment and 1¼-inch Spud \$10.75



149-C.

EMBOSSED WASH DOWN SIPHON. CENTER
OUTLET. WITH DEEP JET.

Code.....Pancale
With Seat Attachment and 1¼-inch Spud \$11.75

Shipping weight, each crated, lbs..... 50
Shipping measurement, each crated, cubic feet. 4

Roughing-in Measurement:

Distance from face of finished wall to center of outlet, 13 inches.

Drawings and Measurements of 148-C and 149-C.

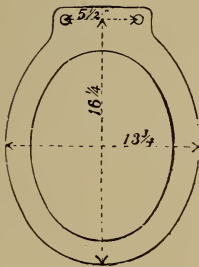

Diagram showing top of Bowl and giving measurements.

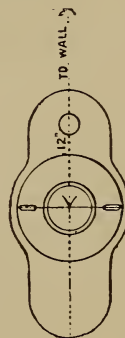

Diagram showing base of Bowl and giving the closest measurement at which Bowl can be set.

This is the best Center Outlet Wash-Down Siphon Bowl on the market. It has a jet inside of bowl at back, running down to the water line; the full force of the water as it leaves the jet comes directly in contact with the contents of the bowl, forcing the soil through the trap, thus insuring a perfect discharge at each operation of the closet and does not depend entirely on siphonic action. It has a full round trap throughout, 2¾ inches in diameter; water seal, 3¾ inches, and surface of water measuring 7½x8½ inches.

Packed 12 in a crate; approximate weight, per crate, 600 pounds.

In Orders and Specifications give Plate Numbers.

“VITREOUS CHINA” CLOSET BOWLS.



150-C.

PLAIN WASH DOWN SIPHON. REAR OUTLET.
WITH DEEP JET.

Code Pancarpia
With Seat Attachment and 1¼-inch Spud \$10.75
Code Pancarte
With Seat Attachment and 2-inch Spud... \$11.00



151-C.

EMBOSSED WASH DOWN SIPHON. REAR OUTLET.
WITH DEEP JET.

Code..... Panche
With Seat Attachment and 2-inch Spud... \$12.00

Roughing-in Measurement:

Distance from face of finished wall to center of outlet, high tank combinations, 9¾ inches ; low tank combinations, 13 inches.

Shipping weight, each crated, lbs..... 50
Shipping measurement, each crated, cubic feet..... 4

Drawings and Measurements of 150-C and 151-C.

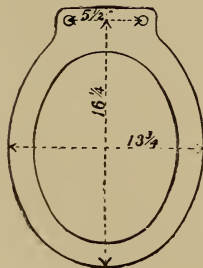

Diagram showing top of Bowl and giving measurements.

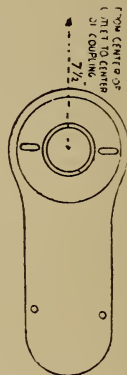

Diagram showing base of Bowl and giving the closest measurement at which Bowl can be set.

This is the best Rear Outlet Wash Down Siphon Bowl on the market. It has a jet inside of bowl at back running down to the water line; the full force of the water as it leaves the jet comes directly in contact with the contents of the bowl, forcing the soil through the trap, thus insuring a perfect discharge at each operation of the closet and does not depend entirely on siphonic action.

It has a full size round trap throughout, 2¾ inches in diameter; water seal, 3¾ inches, and surface of water measuring, 7½x8½ inches.

Packed 12 in crate; approximate weight, per crate, 600 pounds.

In Orders and Specifications give Plate Numbers.

“VITREOUS CHINA” CLOSET BOWLS.



155-C.

PLAIN WASH DOWN SIPHON. CENTER OUT-
LET. WITH SHORT JET.

Code..... Panchetto
With Seat Attachment and 1¼-inch Spud \$9.25



156-C.

PLAIN WASH DOWN SIPHON. REAR OUTLET.
WITH SHORT JET.

Code..... Panchlor
With Seat Attachment and 1¼-inch Spud \$9.25
Code..... Panchrest
With Seat Attachment and 2-inch Spud.. \$9.50

Roughing-in Measurements:

Distance from face of finished wall to center of outlet on high tank combinations for center outlet Bowls, 13 inches; for rear outlet Bowls, 9¾ inches. On low down combinations, 13 inches.



† 157-C.

PLAIN WASH DOWN SIPHON JET. HOPPER AND TRAP.
2¼-inch Trap. 3¾-inch Seal. Surface of water, 7x8 inches.

Code..... Panchrom
With Seat Attachment and 1¼-inch Spud..... \$10.75

Roughing-in Measurement:

Distance from face of finished wall to center of outlet, 13 inches.

Shipping weight of all Bowls on this page, lbs..... 45
Shipping measurements of all Bowls on this page, cubic feet..... 4

† Carried in San Francisco only.

In Orders and Specifications give Plate Numbers.

“VITREOUS CHINA” CLOSET BOWLS.

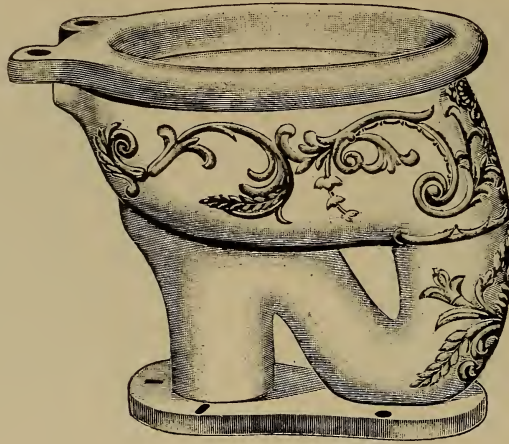

† 160-C.

APTOS NO. 2 EMBOSSED FRONT WASHOUT PEDESTAL. 1¼-INCH INLET.

Code.....	Pancista
No. 2—Washout Pedestal Seat Attachment. No vent.....	\$13.00
Over all, inches.....	22
Top, inches.....	14x17
Shipping weight, lbs.....	55
Shipping measurement, cubic feet.....	4

Roughing-in Measurement:

Distance from face of finished wall to center of outlet, 9¾ inches.

REGULAR PORCELAIN CLOSET BOWLS.



165-C.



†166-C.

No. 3. PLAIN WASHOUT WITH SEAT ATTACHMENT. NO VENT.

No. 3. EMBOSSED WASHOUT WITH SEAT ATTACHMENT. NO VENT.

Code.	No. 3.	Plain Washout with Seat Attachment and 1¼-inch Spud.	No Vent.....	\$ 8.75	
Pancratia	No. 3.	“ “ “ “ “ “ “ “ “ “ “ “	and Vent.....	9.50	
Pancudo	No. 3.	“ “ “ “ “ “ “ “ “ “ “ “	“ “ “ “ “ “ “ “	9.75	
Pandact	No. 3.	Embossed Washout with Seat Attachment and 1¼-inch Spud.	No Vent.....	10.50	
Pandaran	No. 3.	“ “ “ “ “ “ “ “ “ “ “ “	“ “ “ “ “ “ “ “	and Vent.....	10.50

Shipping weight, each crated, lbs.....	50
Shipping measurement, each crated, cubic feet.....	4

Roughing-in Measurements:

Distance from face of finished wall to center of outlet, 9 inches.

† Carried in San Francisco only.

In Orders and Specifications give Plate Numbers.

“REGULAR PORCELAIN” CLOSET BOWLS.



†170-C.

No. 3 PLAIN OFFSET WASHOUT BOWL WITH SEAT ATTACHMENT. NO VENT.

Code.....	Pandecte
No. 3 Plain Offset Washout with Seat Attachment and 1¼-inch Spud. No Vent.....	\$8.75
Shipping weight crated, lbs.....	42
Shipping measurement, cubic feet.....	4

Roughing-in Measurement:

Distance from face of finished wall to center of outlet, 11½ inches.

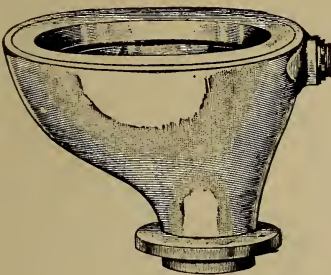

†172-C.

SHORT OVAL FLUSH RIM HOPPER.

Outside of Top, 13¾x16 inches. Height from Flange to Top, 9½ inches. Outlet, 4 inches. 1¼-inch Inlet Spud.

Code.....	Pandemia
Short Oval Flush Rim Hopper.....	\$3.90
Shipping weight each, lbs.....	22
Shipping measurement, cubic feet.....	2½

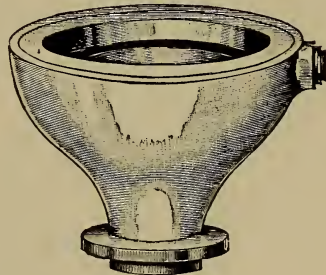

†174-C.

SHORT ROUND FLUSH RIM HOPPER.

Outside diameter of Top, 14 inches. Height from Flange to Top, 9½ inches. Outlet, 4 inches. 1¼-inch Inlet Spud.

Code.....	Pandicol
Short Round Flush Rim Hopper.....	\$2.90
Shipping weight each, lbs.....	20
Shipping measurement, cubic feet.....	2

† Carried in San Francisco only.

In Orders and Specifications give Plate Numbers.

† “COLMA” CLOSET.

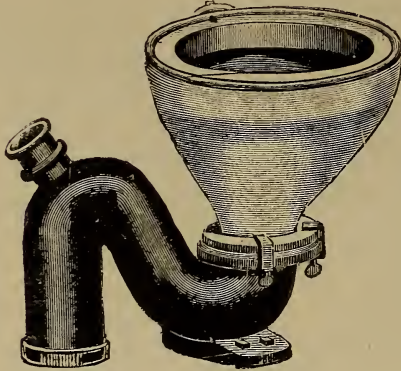

176-C.

SHORT OVAL FLUSHING RIM PORCELAIN HOPPER.

(13¾ x 16 inches outside top measurement), 4-inch Cast Iron Trap, Enameled inside, with 2-inch Hub for Vent, and three 1¾-inch Brass Clamps.

Code.....	Pandise
Price as described.....	\$7.50
Distance from center of outlet in bowl to center of outlet in trap, inches.....	10½
“ “ “ “ “ “ “ “ “ “ “ “ face of finished wall, inches.....	8½
Height from floor, inches.....	16¾
Shipping weight, lbs.....	40
Shipping measurement, cubic feet.....	3

† “TOWNSEND” CLOSET.

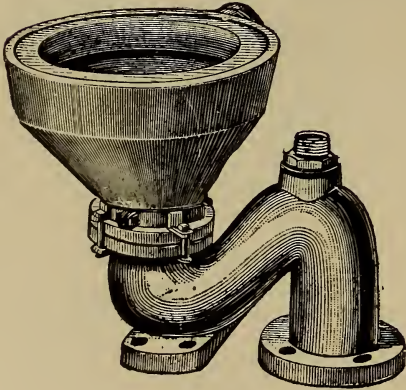

178-C.

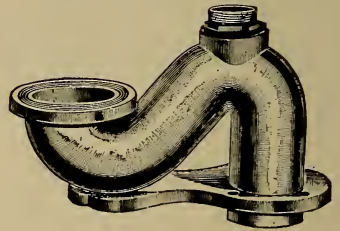

179-C.

SHORT OVAL FLUSHING RIM PORCELAIN HOPPER.

(13¾ x 16 inches outside top measurement), 4-inch Porcelain Trap with 2-inch Vent Spud and Clamps.

Code.....	Pandorga
Price as described... ..	\$7.50
Distance from center of outlet in bowl to center of outlet in trap, inches.....	10½
“ “ “ “ “ “ “ “ “ “ “ “ face of finished wall, inches.....	8½
Height from floor to top of bowl, inches.....	16¾
Shipping weight, lbs.....	45
Shipping measurement, cubic feet.....	3½

† Carried in San Francisco only.

In Orders and Specifications give Plate Numbers.

PORCELAIN FLUSH RIM HOPPERS.



† 181-C.

TALL ROUND FLUSHING RIM PORCELAIN HOPPER. SEAT ATTACHMENT
 1¼-inch Inlet. 4-inch Outlet. Height from Flange to Top, 14½ inches.

Code.....	Pandosia
Tall Round Flush Rim Porcelain Hopper with 1¼-inch Spud	\$5.75
Shipping weight, lbs.....	35
Shipping measurement, cubic feet.....	3¾

JERSEY HOPPER.



† 183-C.

TALL OVAL FLUSHING RIM PORCELAIN HOPPER. SEAT ATTACHMENT.
 1¼-inch Inlet. 4-inch Outlet. Height from Flange to Top, 16 inches.

Code.....	Pandours
Tall Oval Flushing Rim Porcelain Hopper with 1¼-inch Spud.....	\$7.25
Shipping weight, lbs.....	40
Shipping measurement, cubic feet.....	3¾

† Carried in San Francisco only.

In Orders and Specifications give Plate Numbers.

PORCELAIN ENAMELED CLOSET BOWLS.



185-C.

ENAMELED IRON FRONT WASHOUT. 1¼-INCH INLET. ROLL TOP FLUSHING RIM.

Code.												
Pandowy	Enameled inside and outside	Washout with Roll Rim and Seat Lugs.	No Vent.....	\$13.75								
Pandroso	“ “ Painted	“ “ “ “ “ “ “ “ “ “ “ “	“ “	11.15								
Pandspel	“ “ “ “ “ “ “ “ “ “ “ “	With Vent.....		11.50								
	Shipping weight each, lbs			78								
	Shipping measurement each, cubic feet			4½								

Distance from face of finished wall to center of outlet, 9½ inches.



187-C.

ENAMELED IRON SIPHON JET. ROLL TOP. FLUSHING RIM.

Code.				
Pandya	Enl'd inside and outside with 1½-in. Spud	\$18.00		
Paneas	“ “ “ “ “ 2-in. “	18.00		
	Shipping weight, lbs.....	80		
	Shipping meas., cubic feet.....	...		

Distance from face of finished wall to center of outlet, for High Tank combination, 12 inches; for Low Down combination, 13¾ inches.



189-C.

ENAMELED IRON WASH DOWN SIPHON. ROLL TOP. FLUSHING RIM.

Code.				
Panelle	Enl'd inside and outside with 1¼-in. Spud	\$17.00		
Panemone	“ “ “ “ “ 2-in. “	17.00		
Panerina	“ “ Painted “ “ 1¼-in. “	15.00		
Paneroti	“ “ “ “ “ 2-in. “	15.00		
	Shipping weight, lbs.....	85		
	Shipping meas., cubic feet.....	4		

Distance from face of finished wall to center of outlet, for High Tank combination, 13 inches; for Low Down combination, 15 inches.

In Orders and Specifications give Plate Numbers.

TALL FLUSHING ROLL RIM HOPPERS.

WITH SEAT LUGS AND BRASS SPUD AND COUPLING.



†191-C.

TALL ROUND ENAMELED INSIDE, PAINTED OUTSIDE. 1¼-INCH SPUD AND COUPLING.

Code.....	Panetela
Each.....	\$10.00
Shipping weight each, lbs.....	48
Shipping measurement, cubic feet.....	4½
Outside diameter of top, inches.....	16¼
Height from flange, inches.....	15¾
Center to center of seat lugs, inches	5½

Outlet for 4-inch cast iron soil pipe.
Distance from center of outlet to face of finished wall, 11½ inches.



†193-C.

TALL OVAL ENAMELED INSIDE, PAINTED OUTSIDE. 1¼-INCH SPUD AND COUPLING.

Code..	Panfane
Each.....	\$11.00
Shipping weight each, lbs.....	50
Shipping measurement, cubic feet.....	4¾
Outside measurement of top, inches....	16½x15
Height from flange, inches.....	16¾
Center to center of seat lugs, inches....	5½

Outlet for 4-inch cast iron soil pipe.
Distance from center of outlet to face of finished wall, 7½ inches.

The above hoppers may be used with or without wood seats.

† Carried in San Francisco only.

In Orders and Specifications give Plate Numbers.

HOPPER AND TRAP VALVE CLOSETS.

WITH ROUND SELF-RAISING SEATS AND ECLIPSE DOUBLE-ACTING SEAT VALVES.

HOPPERS ENAMELED INSIDE AND PAINTED OUTSIDE.

TRAPS PAINTED INSIDE AND OUTSIDE.

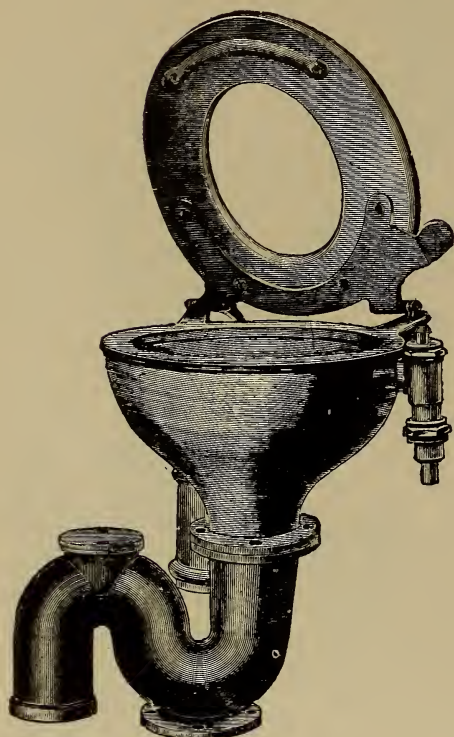

†195-C.

SHORT ROUND HOPPER ON "S" TRAP WITH
HAND HOLE AND COVER.

Code.....	Panfilo
Each.....	\$10.75
Shipping weight, lbs.....	60½
Shipping measurement, cubic feet.....	3¾



†197-C.

SHORT ROUND HOPPER ON "S" TRAP WITH
ANGLE HUB VENT.

Code.....	Pangam
Each.....	\$10.75
Shipping weight, lbs.....	60½
Shipping measurement, cubic feet.....	3¾

Outside diameter of top, 13 inches. Height from flange, 17 inches.
Outlet for 4-inch cast soil pipe. Supply Coupling for ½-inch Lead Pipe.

Distance from center of Trap outlet to center of Bowl, 11 inches.

The Eclipse Valve is double-acting and gives long and satisfactory service. It works well under any pressure from 5 to 200 pounds, without reaction, and can be regulated to give the length of flush desired by screwing the stem up or down.

† Carried in San Francisco only.

In Orders and Specifications give Plate Numbers.

HOPPER VALVE CLOSETS.

WITH ROUND SELF-RAISING SEATS AND ECLIPSE DOUBLE-ACTING SEAT VALVES.

ENAMELED INSIDE AND PAINTED OUTSIDE.

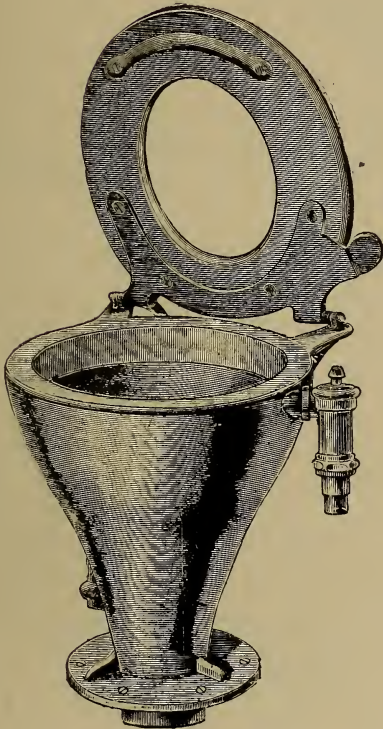

†199-C.

TALL ROUND FLUSHING RIM HOPPER.

Code.....	Pangases
Each.....	\$11.25
Shipping weight, lbs.....	56
Shipping measurement, cubic feet.....	3

Outside diameter of top, 19 inches. Height from flange, 16½ inches. Outlet for 4-inch cast soil pipe.

Distance from center of outlet to face of finished wall, 14 inches.

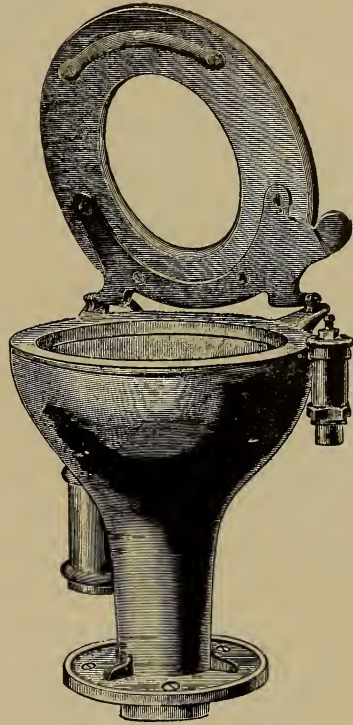

†201-C.

TALL ROUND HOPPER.

Code	Pangendo
Each.....	\$9.00
Shipping weight, lbs.....	41
Shipping measurement, cubic feet.....	3

Outside diameter of top, 14½ inches. Height from flange, 16 inches. Outlet for 4-inch cast soil pipe.

Distance from center of outlet to face of finished wall, 13 inches.

Supply Couplings for ½-inch Lead Pipe.

The Eclipse Valves furnished with above Hoppers are double-acting and have proved capable of long and satisfactory service. They work well under any pressure from 5 to 200 pounds without re-acton and can be regulated to give the length of flush desired by screwing the stem up or down.

†Carried in San Francisco only.

In Orders and Specifications give Plate Numbers.

TALL FLUSHING RIM HOPPERS.

WITH 1¼-INCH BRASS SPUD AND COUPLING FOR TANK CONNECTIONS.



†203-C.

TALL ROUND FLUSHING RIM HOPPER.
ENAMELED INSIDE, PAINTED
OUTSIDE.

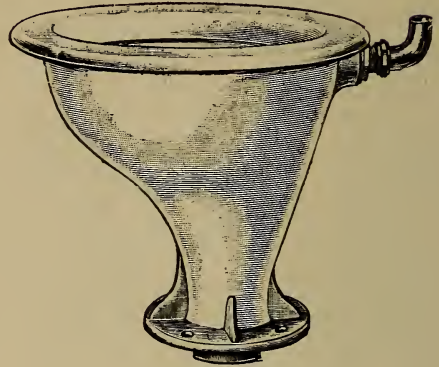

†205-C.

TALL OVAL UNION FLUSHING RIM SHIP'S HOPPER
EXTRA HEAVY. ENAMELED INSIDE AND OUTSIDE.
WITH 3½-INCH FLAT ENAMELED ROLL RIM.

Code.....	Pangenet
Each.....	\$5.00
Shipping weight, lbs.....	35
Shipping measurement, cubic feet.....	3¼

Outside top diameter, 15 inches. Height from flange, 15½ inches. Outlet for 4-inch cast soil pipe.

Distance from center of outlet to face of finished wall, 11½ inches.

Code.....	Pangiace
Each.....	\$12.20
Shipping weight, lbs.....	98
Shipping measurement, cubic feet.....	4

Outside top measurement, 17¾x15½ inches. Height from flange, 16½ inches. Outlet for 4-inch cast soil pipe.

Distance from center of outlet to face of finished wall, 11 inches.

205-C may be used without wooden seat and is especially adapted for use on battleships and other vessels.

†Carried in San Francisco only.

In Orders and Specifications give Plate Numbers.

SHORT OR FRENCH PATTERN HOPPER.

ENAMELED INSIDE. PAINTED OUTSIDE. WITH SIDE ARM INLET.

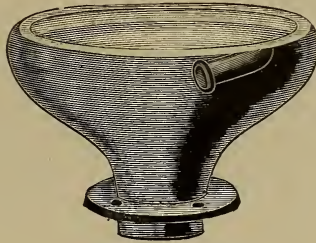

† 207-C.

Height from flange to top, 8 inches; 4-inch outlet; outside top diameter, 13½ inches.

Code.....	Pangoline
Each.....	\$2.75
Shipping weight, lbs.....	15
Shipping measurement, cubic feet.....	1½

PHILADELPHIA HOPPER. NEW PATTERN HOPPER.

ENAMELED INSIDE. SIDE ARM.

ENAMELED INSIDE. SIDE ARM.

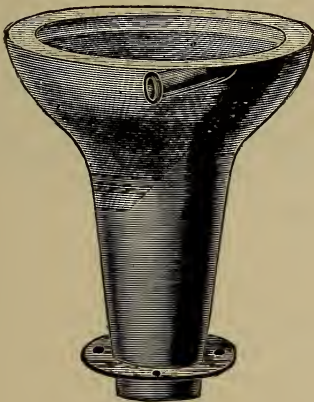

† 209-C.

Height from flange to top, 15½ inches; outlet for 4-inch Cast Soil Pipe; outside top diameter, 13 inches.

Code.....	Pangonum
Each.....	\$2.75
Shipping weight, lbs.....	21
Shipping meas., cubic feet.....	2½

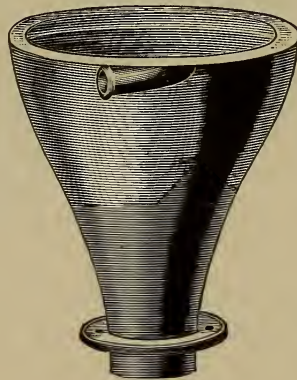

† 211-C.

Height from flange to top, 15½ inches; outlet for 4-inch Cast Soil Pipe; outside top diameter, 13¼ inches.

Code.....	Pangues
Each.....	\$2.75
Shipping weight, lbs.....	23
Shipping meas., cubic feet.....	3

† Carried in San Francisco only.

In Orders and Specifications give Plate Numbers.

H. M. & S. SIPHON CLOSET TANKS.

WITH PATENT TANK BOARDS.

NATURAL OAK. BEADED AND VARNISHED.

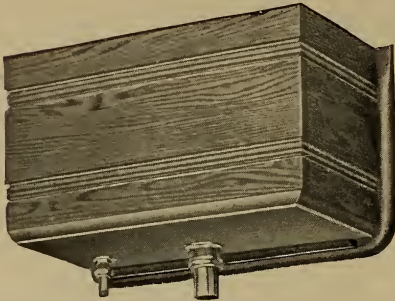

215-C.

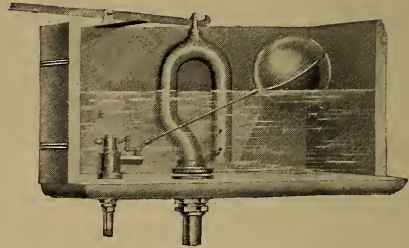

216-C.

Cut shows style of Nos. 90 and 95.

Sectional view of H. M. & S. Siphon Tanks.

Code	Panhormo	Panicful	Panicola	Paniculate
Numbers.....	90 Zinc Lined	90 Copper Lined	†95 Zinc Lined	†95 Copper Lined
Size of siphon, inches	1¼	1¼	1¼	1¼
Inside dimensions, inches	17x8x10	17x8x10	20x9x10	20x9x10
Capacity, gallons	5½	5½	7½	7½
Each complete	\$4.95	5.40	6.35	6.95
Shipping weight, lbs.....	35	35	49	49
Shipping measurement, cubic feet.....	3	3	3½	3½

NATURAL OAK. ROUND CORNERED AND MOULDED.

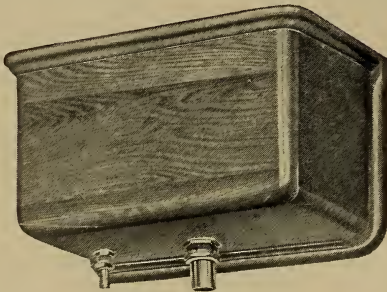

217-C.

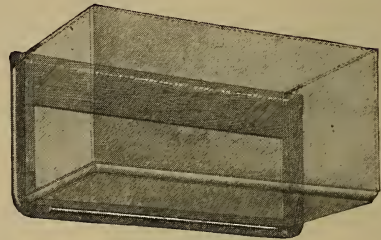

218-C.

Cut shows style of Nos. 101 and 102.

Sectional view showing use of Tank and Board.

Code	Paniegas	Panicem	Panifer	Panigeris
Numbers.....	101 Zinc Lined	101 Copper Lined	102 Zinc Lined	102 Copper Lined
Size of Siphon, inches	1¼	1¼	1¼	1¼
Inside dimensions, inches.....	17x8x10	17x8x10	20x9x10	20x9x10
Capacity, gallons.....	5½	5½	7½	7½
Each complete.....	\$5.55	6.00	6.25	6.85
Shipping weight, lbs.....	36	36	49	49
Shipping measurement, cubic feet.....	3¼	3¼	3¾	3¾

The above tanks are furnished complete with all trimmings ready to set up. The Patent Tank Boards are furnished instead of brackets, enabling the plumber to quickly and securely put the tank up by nailing tank board to wall and securing tank to same by means of clamps furnished with each tank.

No. 10 Zinc is used in lining all zinc lined Tanks.

The Ball Cocks furnished are of Improved design, simple in construction, practically noiseless and suitable for either high or low pressure.

Supply and Flush Couplings are nickel-plated. Supply Tail Pieces are threaded for ¾-inch iron pipe.

† Carried in San Francisco only.

In Orders and Specifications give Plate Numbers and Stock Numbers.

H. M. & S. SIPHON CLOSET TANKS.

WITH PATENT TANK BOARDS.

NATURAL OAK, ROUND CORNERED AND MOULDED FOR SIPHON JET AND WASH DOWN CLOSET BOWLS.

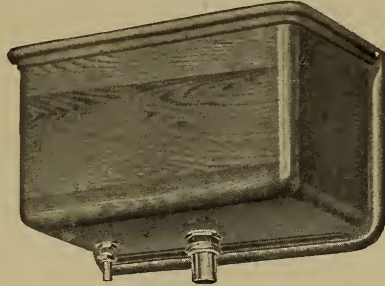

219-C.

Cut shows style of No. 103 Tank. Interior construction same as 216-C.

Code.....	Paniscus	Panizal
Numbers.....	103 Zinc Lined	103 Copper Lined
Size of Siphon, inches.....	1½	1½
Inside dimensions, inches.....	20x9x10	20x9x10
Capacity, gallons.....	7½	7½
Each complete.....	\$6.80	7.40
Shipping weight, lbs.....	51	51
Shipping measurement, cubic feet.....	3¾	3¾

One in a crate.

† **ENAMELED IRON CLOSET TANKS.**

ROUND CORNER. GALVANIZED GOOSE-NECK SIPHON VALVE.

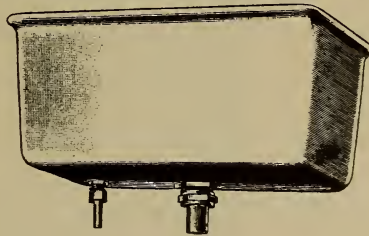

220-C.

These Tanks may be used with any of our Siphon, Jet or Wash Down high tank combinations.

Code.....	Panizette	Panizur
Number.....	1	2
Finish.....	{ Enameled Inside Painted Outside	{ Enameled Inside and Outside
Size of Siphon, inches.....	1½	1½
Inside dimensions, inches.....	21x9x11	21x9x11
Capacity, gallons.....	8	8
Each complete.....	\$9.25	11.00
Shipping weight each, lbs.....	71	75
Shipping measurement each, cubic feet.....	2	2

Four in a crate.

Measurements:—Center of flush to wall, 3 inches ; center of supply to wall, 4 inches ; center of flush to center of supply, 5½ inches ; supply, ¾-inch iron pipe or ½-inch slip joint ; flush connection 1½ inch.

† Carried in San Francisco only.

In Orders and Specifications give Plate Numbers.

H. M. & S. LOW DOWN CLOSET TANKS.



223-C.

Numbers 123 and 124 Tanks.

Are Round Cornered, Hard Finished, either Natural or Golden Oak, with High Pattern Ball Cocks.

Supply and Flush Couplings are Nickel-Plated. Supply Tail Pieces are threaded for 3/8-inch Iron Pipe. No. 10 Zinc is used in lining all Zinc-Lined Tanks.

No. 123 is equipped with Eastwood Flushing Valve.

No. 124 is equipped with Rubber Ball Flushing Valve.

For Italian or Tennessee Marble Top, add to list \$.....

One in a crate.

Code.....	Panjab	Panjail	Panjamo	Panjelly
Numbers.....	123 Zinc Lined	123 Copper Lined	124 Zinc Lined	124 Copper Lined
Size of Flushing Valve, inches.....	2	2	2	2
Inside dimensions, inches.....	19x6x16	19x6x16	19x6x16	19x6x16
Capacity, gallons.....	9½	9½	9½	9½
Each complete.....	\$12.50	13.25	11.00	11.75
Shipping weight, lbs.....	45	45	44	44
Shipping measurement, cubic feet.....	3	3	3	3

224-C No. 126 Tanks.

Are Bent Quartered Oak, either Natural or Golden, Piano Polished.

They are equipped with Eastwood Flushing Valve and High Pattern Ball Cocks.

Supply and Flush Couplings are Nickel-Plated. Supply Tail Pieces are threaded for 3/8-inch iron pipe.

No. 10 Zinc is used in lining all Zinc-Lined Tanks.

One in a crate.



224-C.

Code.....	Panjeoz	Panjeur
Numbers.....	126 Zinc Lined	126 Copper Lined
Inside dimensions, inches.....	19x6x16	19x6x16
Capacity, gallons.....	9½	9½
Each complete.....	\$14.00	\$14.75
Shipping weight, lbs.....	45	45
Shipping measurement, cubic feet.....	3½	3½

In Orders and Specifications give Plate Numbers.

CLOSET SEATS.

FOR SEAT ATTACHMENT BOWLS.



225-C.

Cut shows No. 020½.

NATURAL OAK VARNISH FINISH WOOD STRIP SEAT.



226-C.

Cut shows Nos. 20 and 20½.

NATURAL OAK VARNISH FINISH WOOD STRIP SEAT.



227-C.

Cut shows Nos. 21 and 22.

NATURAL OAK VARNISH FINISH WOOD STRIP SEAT. FOR ROUND HOPPERS.



228-C.

Cut shows No. 23.

NATURAL OAK VARNISH FINISH WITH BRASS NICKEL-PLATED STRAIGHT POST HINGES.

Code.....	Panjiles	Pankruit	Pannary	Pannefin	Panneos	Pannikin
Numbers.....	† 020½	20	20½	† 21	† 22	23
*Measure of seat, inches.....	15½x17¾	15x17½	15x17½	15¾x17½	16x16½	15x17½
Thickness, inches.....	1	1¼	1	1¼	1¼	1¼
Each.....	\$1.65	2.00	1.85	2.00	2.00	2.85
Shipping weight, lbs.....	7	11	11	11	11	11
Shipping meas. cu. ft.....	⅔	1⅓	1⅓	1⅓	1⅓	1⅓

One in a case.

Number 21 fits Round Porcelain Hoppers, plate 81-C.
 Number 22 fits Round Enameled Hoppers, plate 92-C.

*The measure of above seats is the extreme width and the length from front to nickel-plated post or bolt that secures seat to bowl.

† Carried in San Francisco only.

In Orders and Specifications give Plate Numbers and Stock Numbers.

“CROWN” NEVER SPLIT CLOSET SEATS.

THE BEST MADE.



235-C.

Ninety per cent of the Closet Seats in actual use open up in the joints inside of two years, and when placed in very damp or hot places in much less time.

The reason is that all Closet Seats are exposed to dampness and heat which makes the wood either swell or shrink, and seats put together with glued joints only cannot under above conditions help coming apart.

Dampness and heat do not effect “Never Split Seats.” Notice construction in cut above.

Glued and Doweled joints same as on all other seats; besides one iron bolt in each joint.

See page 99 for prices.

In Orders and Specifications give Plate Numbers.

† “CROWN” NEVER SPLIT CLOSET SEATS.

See description and sectional cut on page 98.



236-C.

No. 30 Natural Oak Seat Varnish Finish, with Cast Brass Nickel-Plated Straight Post Hinges.

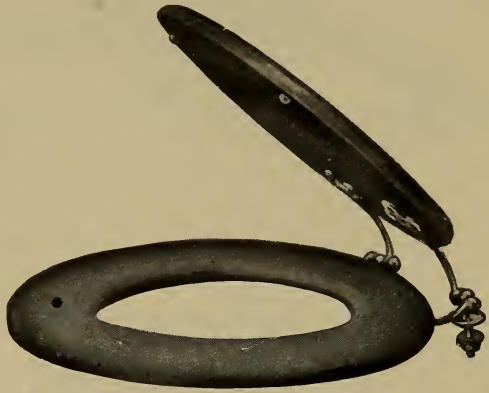

237-C.

No. 31 Natural Oak Seat Varnish Finish, with Extra Heavy Cast Brass Nickel-Plated Straight Post Hinges.



238-C.

No. 32 Natural Oak Saddle Seat Piano Finish with Extra Heavy Cast Brass Nickel-Plated Offset Hinges.

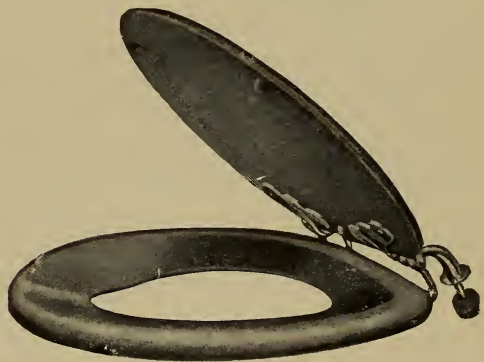

239-C.

No. 33 Natural Oak Saddle Seat Piano Finish, with Extra Heavy Cast Brass Nickel-Plated Offset Hinges.

Code.....	Pannum	Panocha	Panojas	Panoleria
Numbers.....	30	31	32	33
*Measurement of Seat, inches.....	15x17	15x17 1/4	14 1/4 x17 1/2	14 1/4 x17 1/2
Thickness of Seat, inches.....	1 1/4	1 1/4	1 1/2	1 1/2
Each.....	\$3.30	3.85	5.45	6.00
Shipping weight, lbs.....	12	12	11 1/2	11
Shipping measurement, cubic feet.....	3/4	3/4	3/4	3/4

One in a crate.

† Carried in San Francisco only.

* The measure of above seats is the extreme width and the length from front to Nickel-Plated Post that secures seat to bowl.

In Orders and Specifications give Plate Numbers and Stock Numbers.

L. of C.

CLOSET SEATS.

FOR ROUND OR OVAL BOWLS AND HOPPERS WITHOUT SEAT LUGS.



245-C.

Cut shows Nos. 040 and 040½.

NATURAL OAK. VARNISH FINISH SEAT.

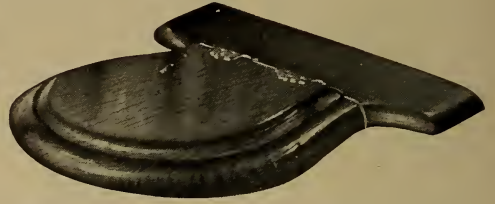

246-C.

Cut shows No. 40½.

NATURAL OAK. VARNISH FINISH SEAT.



247-C.

Cut shows Nos. 41 and 41½.

NATURAL OAK. VARNISH FINISH SEAT.



248-C.

Cut shows No. 42½.

NATURAL OAK. VARNISH FINISH SEAT.

Code.....	Panopea	Panoplia	Panopside	Panoptes	Panorama	Panorpide
Numbers.....	†040	040½	40½	†41	41½	†42½
Thickness, inches.....	1¼	1	1	1¼	1	1
Each.....	\$1.75	1.65	1.95	2.40	2.30	3.05
Shipping weight, lbs.....	13½	10½	14	22½	19½	19½
Shipping measurement, cubic feet.....	1	1	1	1⅓	1⅓	1⅓

One in a case.

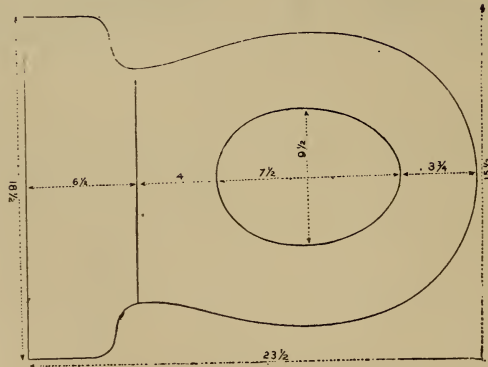

249-C.

This diagram gives the correct measurements for setting oval or round bowls for above seats.

† Carried in San Francisco only.

In Orders and Specifications give Plate Numbers and Stock Numbers.

CLOSET FLUSH AND SUPPLY PIPES.

BRASS NICKEL-PLATED.



255-C. OFFSET FLUSH PIPE.



256-C. OFFSET SUPPLY PIPE.

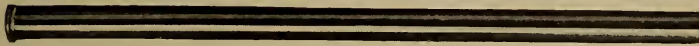

257-C. STRAIGHT FLUSH PIPE.



259-C. STRAIGHT LOW DOWN CLOSET SUPPLY PIPE.



258-C. STRAIGHT SUPPLY PIPE.

Flush Pipes are 72 inches long. Supply Pipes are 84 inches long. Low Down Closet Supply Pipes are 21 inches long.

Nickel-Plated Offset Closet Flush Pipe, 255-C.

Code.	
Panotype	1 1/4-inch, Nickel-Plated Offset Closet Flush Pipe, weight, 2 1/4 lbs., each..... \$1.65

Nickel-Plated Straight Closet Flush Pipe, 257-C.

Panoura	1 1/2-inch, Nickel-Plated Straight Closet Flush Pipe, weight, 3 lbs., each 2.20
---------	---

Nickel-Plated Offset Closet Supply Pipe, 256-C.

Pansait	5/8-inch, Nickel-Plated Tubing, Offset Closet Supply Pipe, weight 1 3/4 lbs., each..... 1.50
† Panscope	3/8-inch, Nickel-Plated, iron pipe size, Offset Closet Supply Pipe, weight, 3 3/4 lbs., each 2.50

Nickel-Plated Straight Closet Supply Pipe, 258-C.

† Panterne	5/8-inch, Nickel-Plated, Tubing Straight Closet Supply Pipe, weight, 1 3/4 lbs., each.... 1.50
† Pansophie	3/8-inch, Nickel-Plated, iron pipe size, Straight Closet Supply Pipe, weight, 3 3/4 lbs., ea. 2.50

Nickel-Plated Straight Low Down Closet Supply Pipe, 259-C.

† Pansuros	3/8-inch, Nickel-Plated, iron pipe size, Straight Low Down Closet Supply Pipe, weight, 1 3/4 lbs., each50
------------	---

† Carried in San Francisco only.

In Orders and Specifications give Plate Numbers and Sizes.

ANGLE SLIP JOINT CLOSET SUPPLIES.

BRASS NICKEL-PLATED.

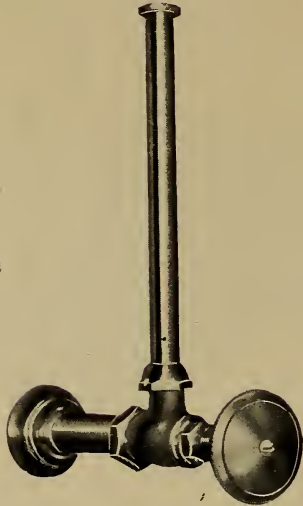

† 265-C.

WHEEL HANDLE ANGLE SLIP JOINT
CLOSET SUPPLY.

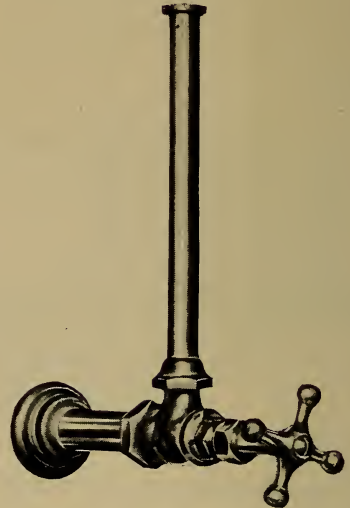

266-C.

CROSS HANDLE ANGLE SLIP JOINT
CLOSET SUPPLY.

Code..... Pantable
Each..... \$1.40
Weight each, lbs 1

Code..... Pantables
Each..... \$1.40
Weight each, lbs 1

The valves furnished for above supplies have ground seat; they have inside 1/2-inch iron pipe thread for inlet and 3/16-inch slip joint connection outlet. The collar on tube fits the supply coupling nut on all of our tanks and is 7/8-inch outside diameter. The nipple to wall is nickel-plated brass, 1/2-inch (iron pipe size) and 4 inches long.

This supply will rough in at 9 inches from center of inlet to bottom of tank.

† Carried in San Francisco only.

In Orders and Specifications give Plate Numbers and Sizes.

SLIP JOINT SUPPLY VALVES.

INSIDE IRON PIPE THREADS ONE END AND SLIP JOINT CONNECTION ON THE OTHER



270-C.



271-C.

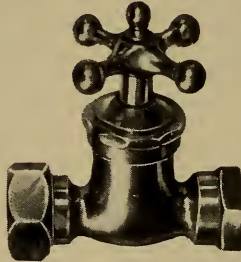

272-C.



273-C.

Cross Handle Nickel-Plated Angle Slip Joint Supply Valve.

Wheel Handle Nickel-Plated Angle Slip Joint Supply Valve.

Cross Handle Nickel-Plated Straight Slip Joint Supply Valve.

Wheel Handle Nickel-Plated Straight Slip Joint Supply Valve.

Finished Nickel-Plated Angle Slip Joint Supply Valves, 270-C and 271-C.

Code	Each
Pantagam..... $\frac{3}{8}$ -inch Iron Pipe by $\frac{1}{2}$ -inch Slip Joint, Cross Handle. Weight, $\frac{3}{4}$ lb.....	\$0.76
†Pantagath..... $\frac{3}{8}$ " " " " $\frac{1}{2}$ " " " Wheel " " $\frac{3}{4}$ ".....	.76
†Pantalla..... $\frac{3}{8}$ " " " " $\frac{5}{8}$ " " " Cross " " $\frac{3}{4}$ ".....	1.06
†Pantalon..... $\frac{3}{8}$ " " " " $\frac{5}{8}$ " " " Wheel " " $\frac{3}{4}$ ".....	1.06
†Pantamer..... $\frac{1}{2}$ " " " " $\frac{1}{2}$ " " " Cross " " $\frac{3}{4}$ ".....	.76
†Pantanal..... $\frac{1}{2}$ " " " " $\frac{1}{2}$ " " " Wheel " " $\frac{3}{4}$ ".....	.76
†Pantanos..... $\frac{1}{2}$ " " " " $\frac{9}{16}$ " " " Cross " " $\frac{3}{4}$ ".....	.76
†Pantelant..... $\frac{1}{2}$ " " " " $\frac{9}{16}$ " " " Wheel " " $\frac{3}{4}$ ".....	.76
†Pantelium..... $\frac{1}{2}$ " " " " $\frac{5}{8}$ " " " Cross " " 1 ".....	1.06
†Panterkop..... $\frac{1}{2}$ " " " " $\frac{5}{8}$ " " " Wheel " " 1 ".....	1.06

Rough Nickel-Plated Angle Slip Joint Supply Valves, 269-C Not Shown.

Code	Each
Panteus..... $\frac{1}{2}$ -inch Iron Pipe by $\frac{1}{2}$ -inch Slip Joint, Cross Handle. Weight $\frac{3}{4}$ lb.....	\$0.58

Finished Nickel-Plated Straight Slip Joint Supply Valves, 272-C and 273-C.

Code	Each
Pantherin..... $\frac{1}{2}$ -inch Iron Pipe by $\frac{5}{8}$ -inch Slip Joint, Cross Handle. Weight 1 lb.....	\$1.00
Panthoid..... $\frac{1}{2}$ " " " " $\frac{5}{8}$ " " " Wheel " " 1 ".....	1.00
Panticap..... $\frac{3}{8}$ " " " " $\frac{5}{8}$ " " " Tee " " $\frac{3}{4}$ ".....	1.00

One-half dozen in a package.

† Carried in San Francisco only.

In Orders and Specifications give Plate Numbers and Sizes.

ANGLE VALVES FOR CLOSET SUPPLIES.

ALL IRON PIPE THREADS.



274-C.



275-C.



276-C.



277-C.

Cross Handle Nickel-Plated Angle Valve.

Wheel Handle Nickel-Plated Angle Valve.

Rough Nickel-Plated Angle Valve.

Rough Angle Valve.

Finished Nickel-Plated Angle Valves, 274-C and 275-C.

Code	Size	Handle	Weight	Each
Pantiner.....	3/8-inch	Cross Handle	Weight, 3/4 lb.....	\$2.40
Pantoffel.....	3/8 " "	Wheel	" " " " 3/4 "	2.40
†Pantogame....	1/2 x 3/8-inch	Cross	" " " " 3/4 "	2.65
†Pantoire.....	1/2 x 3/8 " "	Wheel	" " " " 3/4 "	2.65
Pantology.....	1/2 " "	Cross	" " " " 1 "	2.65
Pantopoda.....	1/2 " "	Wheel	" " " " 3/4 "	2.65

Rough Nickel-Plated Angle Valves, 276-C.

Pantotele.....	3/8-inch	Rough Nickel-Plated, Angle Valve.	Weight, 3/4 lb.....	1.00
†Pantoun.....	1/2 x 3/8 " "	" " " " " " " " 3/4 "		1.25
Pantuflo.....	1/2 " "	" " " " " " " " 1 "		1.25

Rough Angle Valves, 277-C.

Panunto.....	3/8-inch	Rough Angle Valve.	Weight, 3/4 lb.....	.75
Panurgy.....	1/2 x 3/8 " "	" " " " " " " " 3/4 "		1.00
Panvisch.....	1/2 " "	" " " " " " " " 1 "		1.00

Six in a package.

† Carried in San Francisco only.

In Orders and Specifications give Plate Numbers and Sizes.

CLOSET FLUSH PIPE CONNECTIONS.

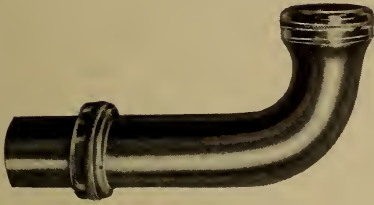

285-C.

Nickel-Plated Slip Joint Flush Pipe Elbow.



286-C.

Nickel-Plated 45° Flush Pipe Elbow.



287-C.

Nickel-Plated 90° Flush Pipe Elbow.



288-C.

Nickel-Plated Slip Joint Nut with Rubber Washer and Nickel-Plated Flange.

Code		Per dozen
Panyard.....	1¼-inch Nickel-Plated Slip Joint Flush Pipe Elbow. 6½ inches from end to back. Weight per dozen, 8¾ lbs.....	\$ 7.20
† Panzano.....	1½-inch Nickel-Plated Slip Joint Flush Pipe Elbow. 7 inches from end to back. Weight per dozen, 10 lbs.....	13.20
† Panzeron.....	1¼-inch Nickel-Plated 45° Flush Pipe Elbow to sweat. Weight per dozen, 2¾ lbs.	4.32
† Panzerst.....	1½ " " " 45° " " " " " " " " " 3¾ " "	6.00
† Panzudas.....	1¼ " " " 90° " " " " " " " " " 2¾ " "	4.32
† Papabile.....	1½ " " " 90° " " " " " " " " " 3¾ " "	6.00
Papacy.....	1½ " " " Slip-Joint Nut with Rubber Washer and Nickel-Plated Flange. Weight per dozen, 1¾ lbs.....	2.16

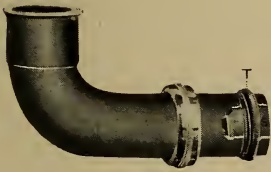

*** 291-C.**

Superior Rubber Elbow.



292-C.

Rickett's Rubber Elbow.



293-C.

Rickett's Straight Rubber Connection.

Code		Per dozen
Papafigo.....	1¼ x 1¼-inch Superior Rubber Elbow. 5½ inches from face to back. Weight per dozen, 3¾ lbs.....	\$ 6.00
† Papalist.....	2x2-inch Superior Rubber Elbow. 5½ inches from face to back. Weight per dozen, 6 lbs.....	12.00
Papally.....	1¼ x 1¼-inch Superior Straight Rubber Connection, 4½ inches long. Weight per dozen, 3½ lbs.....	6.00
† Papandujo.....	2x2-inch Superior Straight Rubber Connection, 5 inches long. Weight per dozen, 5½ lbs.....	12.00
† Paparia.....	No. 4 A—1¼-inch Rickett's Rubber Elbow, 5 inches from face to back. Weight per dozen, 4¾ lbs.....	11.00
† Paparicho.....	No. 7—1¼-inch Rickett's Straight Rubber Connection, 5 inches long. Weight per dozen, 3½ lbs.....	7.00

2 x 2-inch Superior, one-half dozen; others, one dozen in a box.

*Superior Connections have Nickel-Plated Brass Nuts. They are the longest Elbows on the market and may be easily shortened by simply removing the brass shell S and cutting off the rubber to any length desired. The soft rubber ring T forms a movable flange.

Rickett's Connections have Rough Brass Nuts. If too long, cut off in line of Rear Flange and slip nut over.

† Carried in San Francisco only.

In Orders and Specifications give Plate Numbers and Sizes.

NICKEL-PLATED POST. NICKEL-PLATED STRAPS.



300-C.

Nickel-Plated Adjustable Flush and Supply Pipe Posts.



301-C.

Nickel-Plated Flush Pipe Straps with Bumper.



302-C.

Nickel-Plated Flush and Supply Pipe Straps Plain.

Nickel-Plated Flush and Supply Pipe Posts, 300-C.

Code		Per dozen.
† Papasso.....	1 1/4-inch Nickel-Plated Adjustable Flush Pipe Post. From wall to center of pipe, 4 inches. Weight per dozen, 1 lb.....	\$4.00
Papaute.....	1 1/2-inch Nickel-Plated Adjustable Flush Pipe Post. From wall to center of pipe, 4 inches. Weight per dozen, 1 1/2 lbs.....	4.56
Papayer.....	5/8-inch Tubing or 3/8-inch Iron Pipe, Nickel-Plated Adjustable Supply Pipe Post. From wall to center of pipe, 4 inches. Weight per dozen, 1 1/2 lbs.....	3.36

Nickel-Plated Flush Pipe Straps with Bumper, 301-C.

Papegot.....	1 1/4-inch Nickel-Plated Flush Pipe Strap with Bumper. Weight per dozen, 1/2 lb.....	1.80
--------------	--	------

Nickel-Plated Flush and Supply Pipe Straps, 302-C.

Papelard	1 1/4-inch Nickel-Plated Flush-Pipe Strap Plain. Weight per dozen, 1/2 lb.....	.58
† Papeline....	1 1/2 " " " " " " " " " " 5/8 ".....	.72
Papelona.....	5/8 " Tubing or 3/8-inch Iron Pipe Nickel-Plated Supply Pipe Straps. Weight per dozen, 1/8 lbs.....	.50

300-C has a Nickel-Plated Socket that is secured to the wall by an ordinary screw which passes through the center of the socket; the post sets into the socket and is held in place by a small set screw. The post is made of Nickel-Plated Tubing and may be cut to the desired length.

301-C and **302-C** are of Stamped Brass Nickel Plated.

RUBBER GASKET. MARBLE SLAB. BRASS FLANGE.



305-C.

Rubber Floor Flange Gasket.



306-C.

Marble Floor Slab.



307-C.

Brass Floor Flange.

Code	Papenmut	Code.....	Paperina	Code.....	Papesco
Each	\$0.16	Price on application.		Each	\$0.50
Weight per doz., lbs.	1 1/2	Weight per sq. ft., 1 1/2 inches thick, lbs..	22 1/2	Weight each, lb.....	3/4

† Carried in San Francisco only.

In Orders and Specifications give Plate Numbers and Sizes.

NICKEL-PLATED BOLTS AND SCREWS.



310-C.

Brass Floor Flange Bolts with Nickel-Plated Nut, 1 1/2 inches.

Code.....Papafian
 Per dozen.....\$1.00
 Weight per gross, lbs. ... 7
 One-half gross in a package.



311-C.

Loose Head Screws for Closet Bases with Nickel-Plated Heads. 2 1/2 inches.

Code.....	Papilles	Papiron
	Iron	Brass
Per dozen.....	\$1.00	2.50
Wt. per gro., lbs..	5 7/8	5
	One gross in a package.	



312-C.

Nickel-Plated Round Head Wood Screws 2-inch No. 12.

Code.....	Papismo	Papistas
	Iron	Brass
Per gross.....	\$2.00	6.40
Wt. per gro., lbs..	2 3/4	3
	One gross in a package.	

NICKEL-PLATED CLOSET WASHERS.



315-C.

Nickel-Plated Round Closet Washer, 1 5/16-inch diameter. 5/16-inch hole.

Code.....Papepel
 Per dozen \$0.25
 Weight per gro., lb..... 3/4
 One gross in a package.



316-C.

Nickel-Plated Oval Closet Washer, 1 5/8 x 1 1/16 inches. 5/16-inch hole.

Code.....Papmeat
 Per dozen..... \$0.30
 Weight per gro., lbs..... 1 1/8
 One gross in a package.

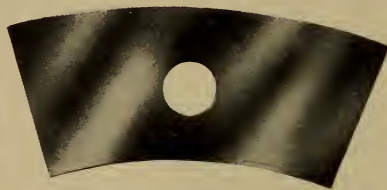

† **317-C.**

Nickel-Plated Crescent Closet Washer, 2 1/4 x 7/8 inches. 5/16-inch hole.

Code.....Paponge
 Per dozen..... \$0.40
 Weight per 100, lbs..... 1 7/8
 One hundred in a package.

† Carried in San Francisco only.

In Orders and Specifications give Plate Numbers and Sizes.



320-C.

Bent Coupling and Nut for Closet Bowls.

Code	Papotage	Papotons
Size, inches.....	1 1/4	2
Each.....	\$0.30	.60
Weight each, lb.....	3/4	1

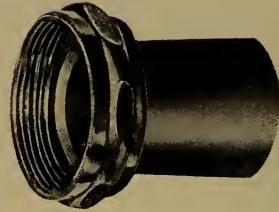

321-C.

Straight Coupling and Nut for Closet Bowls.

Code.....	Papouche	Papoula	Pappamus
Size, inches.....	1 1/4	1 1/2	2
Each.....	\$0.30	.40	.60
Weight each, lb.....	1/4	3/8	3/4

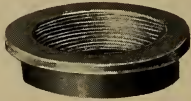

322-C.

Nickel-Plated Brass Flush Pipe Collar Threaded for 1-inch Iron Pipe.

Code.....	Pappandi
Per dozen.....	\$3.00
Weight per doz., lb.....	3/4



325-C.

Canfield Rubber Coupling.

Code	Pappel
Number.....	500
Per dozen.....	\$1.00
Weight per doz., lb.....	1/2

One dozen in a package.

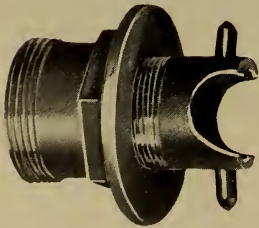

326-C.

*Superior Closet Repairer.

Code.....	Pappeux	Pappicht
Size, inches....	1 1/4	2
Per dozen	\$6.00	12.00
Wt. per doz. lbs...	6	10

One dozen in a box.



† **328-C.**

Hopper and Trap Closet Clamp.

Code.....	Pappoose
Per dozen.....	\$3.00
Weight per doz., lbs.....	2

1 3/4 inches between jaws.

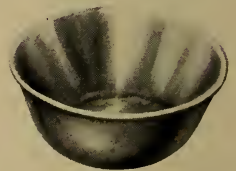

† **330-C.**

Copper Closet Pan. Tinned Inside. 9-in. Diam.

Code	Papschot
Per dozen	\$7.00
Weight per doz., lbs....	9

One-half doz. in a package.

*The Superior Closet Repairer has no screws, nuts, bolts or other loose parts to get lost or to take time in adjusting. No cross pieces to impede the flow of water. A perfectly free water-way and a water-tight joint.

† Carried in San Francisco only.

In Orders and Specifications give Plate Numbers and Sizes.

CLOSET TANK PULLS.

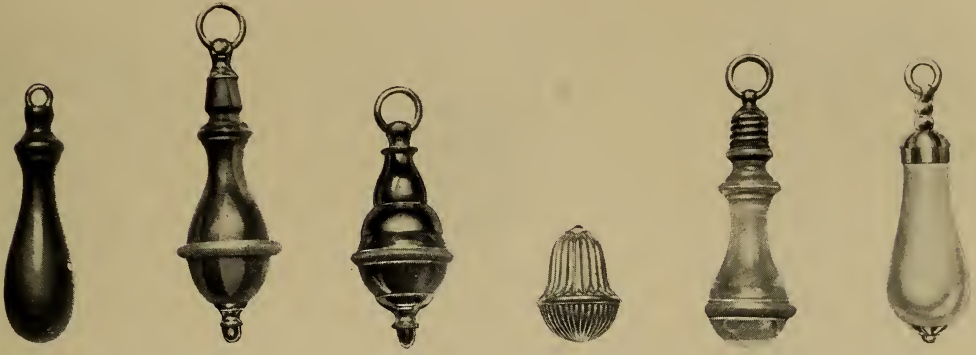

† 335-C. No. 4—Wood.	† 336-C. No. 7—Inlaid.	† 337-C. No. 9—Horn Ball.	† 338-C. Nickel-Plated.	† 339-C. Glass.	† 340-C. China.	
Code.....	Papulose	Papyro	Paqueter	Paquife	Parabaue	Parabling
Numbers.....	4	7	9	Nickel-Plated	Glass	China
Per dozen.....	\$1.00	7.50	5.00	2.00	12.00	18.00
Weight per dozen, lbs.....	7/8	2 1/8	3 1/4	1	3	2 1/2

One dozen in a box.



345-C.
Nickel-Plated "S" Hooks.

Code.....	Parabosco	Parabunt
Size, inches ...	5/8	1 1/8
Per dozen.....	\$0.50	.75



346-C.
Natural Oak Tank Boards.

Code.....	Paraclet	Paraclose
Size Tank, inches.....	17	20
Each	\$1.10	1.20
Weight each, lbs.....	2 1/2	2 3/4



347-C.
Tank Board Clamps.

Code	Paradeta
Per pair.....	\$0.25



† **350-C.**
Glass Tank Ball and Stem 1/32
Rod No. 24 threads.

Code.....	Paradiste
Diameter, inches.....	Glass
Per dozen.....	5
Weight per dozen, lbs.....	\$10.00
	15



351-C.
Zinc Tank Ball with Socket
threaded 1/32 No. 24.



352-C.
Corrugated Copper Tank Ball
with Socket threaded
1/32 No. 24.

Paradoxa	Paradrome
Zinc	Copper
5	5
4.50	5.50
3 3/4	3 1/4

† Carried in San Francisco only.

In Orders and Specifications give Plate Numbers and Sizes.

PARTS FOR CLOSET TANKS.

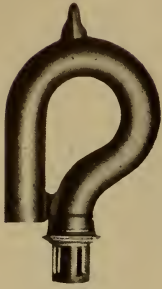

360-C.

Galvanized Gooseneck Siphon.

Code.....	Parafang	Paraferna
Size, inches.....	1¼	1½
Each.....	\$1.50	2.00
Weight each, lbs..	4¼	5¼



361-C.

Brass Siphon Seat.

Code.....	Paraffin	Paraffo
Size, inches.....	1¼	1½
Each.....	\$1.00	1.50
Weight each, lbs..	1	1¼



362-C.

Nickel-Plated Flush Nut and Tail Piece.

Code.....	Parafiez	Parafonia
Size, inches.....	1¼	1½
Each.....	\$0.50	.75
Weight each, lb..	¾	1



363-C.

Rubber Siphon Ring.

Code.....	Parafaso	Parafusar	Paragana
Size, inches.....	1¼	1½	2
Per dozen.....	\$2.40	2.40	3.60
Weight per doz., lbs.	¾	¾	¾



364-C.

Cast Iron Tank Cross Bar.

Code.....	Parageau
Each.....	\$0.40
Weight each, lbs..	½



365-C.

Cast Iron Tank Lever.

Code.....	Paragenic
Each.....	\$0.50
Weight each, lbs..	¾



366-C.

Compound Lever for Ball Cock.

Code.....	Paraglace
Each.....	\$0.50



367-C.

Nickel-Plated Bottom Supply Nut and Tail Piece.
¾-inch Iron Pipe Thread.

Code.....	Paragram
Each.....	\$0.50



368-C.

Nickel-Plated Supply Lock-Nut.

Code.....	Parajour
Each.....	\$0.20



369-C.

Brass Ball Cock Plunger with Cup Leather and Cushion Seat.

Code.....	Paralela
Each.....	\$0.85



370-C.

Brass Ball Cock Screw.

Code.....	Paralian
Each.....	\$0.10



380-C.

Brass Float Stem. 7/32 inch.
No. 14 threads. 7 1/2 inches long.

Code.....	Paralipse
Each.....	\$0.20



381-C.

Cup Leather for Ball Cock.

Code.....	Paralizo
Each.....	\$0.10

In Orders and Specifications give Plate Numbers and Sizes.

BALL COCKS FOR CLOSET TANKS.



383-C.

Compound Lever Ball Cock. Bottom Supply. Tail Piece threaded $\frac{3}{8}$ Iron Pipe. Lever Socket threaded $\frac{7}{32}$ inch No. 14.

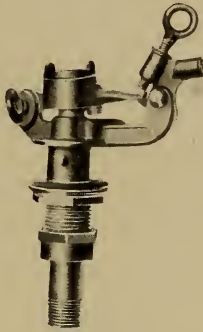

384-C.

Improved Dale Ball Cock. Bottom Supply. Tail Piece threaded $\frac{3}{8}$ -inch Iron Pipe. Lever Socket threaded $\frac{7}{32}$ inch No. 14.

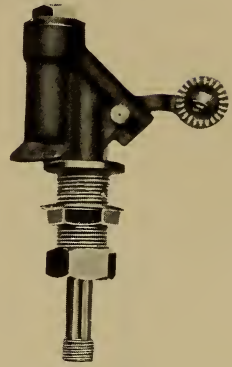

†*385-C.

Foster Patent Ball Cock. Bottom Supply.

Threaded for $\frac{3}{4}$ -inch Iron Pipe with Nickel-Plated Ground Seat Coupling Nut and Tail Piece threaded for $\frac{3}{8}$ -inch Iron Pipe.

Code..... Paralume
Each..... \$2.25
Weight each, lb..... 1

Code..... Paralvise
Each..... \$2.50
Weight each, lb..... $\frac{3}{4}$

Code..... Paralyse
Number..... **1C**
Each..... \$2.50
Weight each, lbs..... $1\frac{1}{2}$
One in a box.



†*386-C.

Foster Patent Ball Cock. Top Supply.

Threaded for $\frac{3}{4}$ -inch Iron Pipe with Ground Seat Coupling Nut and Tail Piece threaded for $\frac{3}{8}$ -inch Iron Pipe.

Code..... Paranete
Number..... **1A**
Each..... \$2.50
Weight each, lbs..... $1\frac{1}{2}$
One in a box.

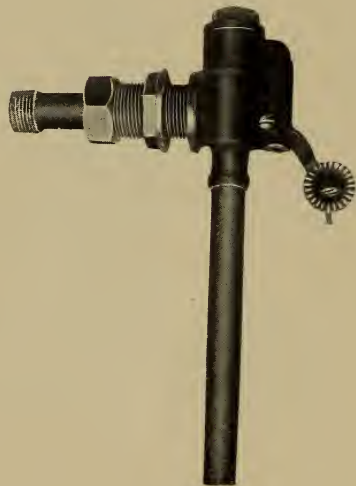

†*387-C.

Foster Patent Ball Cock. End Supply.

Threaded for $\frac{3}{4}$ -inch Iron Pipe with Ground Seat Coupling Nut and Tail Piece threaded for $\frac{3}{8}$ -inch Iron Pipe.

Code..... Parandros
Number..... **1B**
Each..... \$2.50
Weight each, lbs..... $1\frac{1}{2}$
One in a box.

* **385-C, 386-C** and **387-C** are to be used with a 4-inch ball.

† Carried in San Francisco only.

In Orders and Specifications give Plate Numbers.

SEAT BOLTS.

NICKEL-PLATED SEAT HINGES.



390-C.

Nickel-Plated Bolts and Washers for Wood Strip Closet Seats.

Code..... Parangue
Per pair... \$0.75

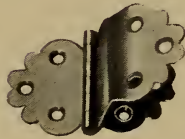

391-C.

Nickel-Plated Double Hinge for Wood Strip Closet Seats.

Code..... Parapeg
Number 20
Per pair..... \$1.20

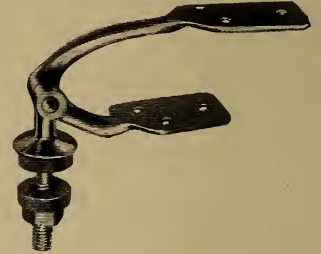

† 392-C.

Nickel-Plated Direct Post Hinge for Closet Seats.

Code..... Paraphero
Number..... 23
Per pair..... \$2.70

HINGE RUBBERS.

RUBBER BUMPERS.



† 400-C.

Seat Hinge Rubbers, 1 1/4-inch diameter.

Code..... Parapiot Parapside
Size hole, inch.. 1/4 1/2
Per dozen... \$1.00 1.00



401-C.

Tack Bumpers.

Code..... Parasang Parasefil
Numbers..... 1 † 2
Diameter, in... 3/8 1/16
Per dozen..... \$0.30 .25



† 402-C.

Fender Tips. Cut shows actual size of No. 2.

Code..... Parasite Parasols
Numbers 2 3
Diameter, inches.. 3/8 3/4
Per dozen..... \$0.20 .30

† Carried in San Francisco only.

SECTION 2.

MARBLE, SLATE AND PORCELAIN URINAL STALLS,

CAST IRON ENAMELED PUBLIC URINALS,

VITREOUS CHINA AND ENAMELED INDIVIDUAL URINALS,

URINAL STALL TRIMMINGS, ETC.

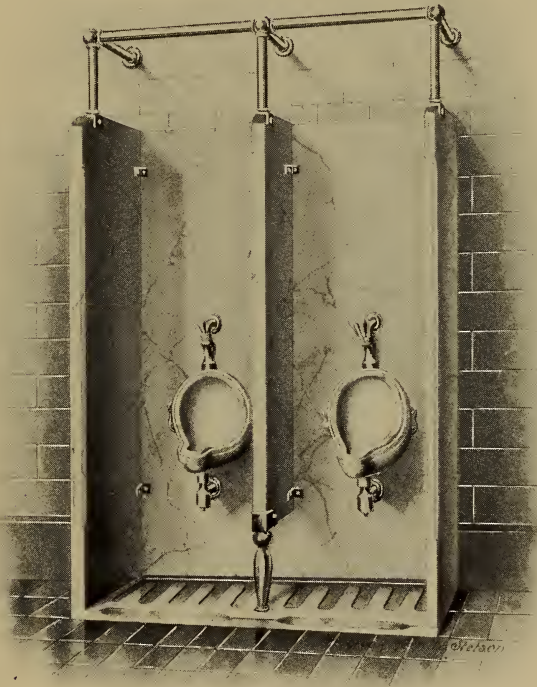

HOLBROOK, MERRILL & STETSON,

INCORPORATED.

SAN FRANCISCO, LOS ANGELES AND NEW YORK.

URINALS, URINAL STALLS, ETC.

Our Marble and Slate Stalls are made of selected stock, and every fixture is properly set and fitted before shipment is made.

All of our goods are of substantial quality and high finish.

In ordering goods from this section by telegraph, it is only necessary to use the code word over or opposite the number or size of the article wanted preceded by words from code in front of this book.

Example: Crogdal one paredros.

Translation: Ship via cheapest route one three-part Italian Marble Urinal Stall, plate four hundred and twenty-three C.

“ FLUSHOMETER ” SIPHON JET URINAL.

KENNEY'S PATENT.



415-C.

Vitreous China Siphon Jet Urinal with outlet to wall and Nickel-Plated Flushometer.

No. 16 Flushometer, for pressures under 6 pounds or where tank is from 6 feet to 12 feet above Urinal.

No. 16½ Flushometer, for pressures 6 to 15 pounds or where tank is from 12 to 30 feet above Urinal.

Code.....	Parastad	Parastyle
Style.....	415-C No. 16 Flushometer	415-C No. 16½ Flushometer
Price as described.....	\$32.00	32.00
Weight each, lbs.....	58	58
Shipping measurement each, cubic feet.....	4⅓	4⅓

Marble extra. Prices on application.

Urinal can be furnished with bottom outlet, nickel-plated, 2-inch pipe to floor, at same price.

Roughing-in Measurements :

Distance from floor to center of Urinal Waste, 18 inches; from center of Urinal Waste to center of Flushometer inlet, 25½ inches; inlet connection, 1-inch iron pipe; outlet connection, 2-inch iron pipe.

See pages 3, 4, 5, 6 for description of Flushometer.

In Orders and Specifications give Plate Numbers.

“FLUSHOMETER” SIPHON JET URINALS.

KENNEY'S PATENT.



416-C.

Three Stall Italian Marble Urinal with 7/8-inch Italian Marble Ends and Partitions polished on both sides; 7/8-inch Italian Marble Back and Top Cap polished on one side; three Nickel-Plated Flushometers; three Vitreous China Siphon Jet Urinals with Brass Wall Flange and Bolts; Nickel-Plated Brass Legs for Partitions; all necessary Bolts, Screws and Clamps.

Dimensions:

Height, 5 feet; center to center of partitions, 2 feet; depth of partitions, 20 inches; depth of ends, 26 inches; leg, 12 inches.

Code for Urinals with Italian Marble Stall Number of Stalls.....	Paratopie 1	Paratopoid 2	Paratopole 3	Paratopud 4	Paratopult 5
Complete as described.....	\$111.10	192.80	270.80	352.50	434.20
Shipping weight, complete, lbs.....	574	921	1268	1615	1962

Price for above Stalls in Tennessee Marble same as for Italian Marble.

Can furnish any number of Stalls as above described; and the height and depth of Stalls may be varied to suit conditions. Floor Slabs can also be furnished. Prices on application.

See page 115 for Roughing-in Measurements; see pages 3, 4, 5, 6 for description of Flushometer.

In ordering always state whether pressure is 10 pounds or over.

Boxing and cartage will be charged at cost.

In Orders and Specifications give Plate Numbers and Number of Stalls.

AUTOMATIC SIPHON JET URINALS.



418-C.

Three Stall Italian Marble Urinal, with 7/8-inch Italian Marble Ends and Partitions polished on both sides; 7/8-inch Italian Marble Back and Top Cap polished on one side, and 1 1/2-inch Counter Sunk Italian Marble Base. Nickel-Plated Brass Clamps and Bolts; Nickel-Plated Inlet and Outlet Connections; 3 Porcelain Siphon Jet Urinals; Nickel-Plated Brass Legs for Partitions; Oak Automatic Flushing Tank, with Patent Tank Board and Nickel-Plated Flush Pipe.

Waste Plugs or Strainers furnished at extra cost.

Dimensions:

Height, 5 feet; center to center of partitions, 2 feet; depth of partitions, 20 inches; depth of ends, 26 inches; base, 24 inches wide; leg, 12 inches.

	Paraturo Parcelle	Paravail Parcendi	Paravent Parchazo	Parboil Parching	Parcement Parcial	Parcebat Parcita
Code for Marble.....	Paraturo	Paravail	Paravent	Parboil	Parcement	Parcebat
Code for Slate.....	Parcelle	Parcendi	Parchazo	Parching	Parcial	Parcita
Number of Stalls.....	1	2	3	4	5	6
Marble complete as described	\$123.00	219.56	309.18	401.14	494.60	586.56
Slate complete as described	110.38	194.00	275.06	359.12	444.68	528.74
Shipping weight complete, lbs.....	705	1130	1557	2082	2415	2840
If without Tank and Flush Pipe, deduct	\$9.70	11.00	13.20	14.90	18.10	19.80

Price for above Stalls in Tennessee Marble same as for Italian Marble.

If with Polished Brass Clamps, Bolts, Connections, Legs and Flush Pipe, deduct for each Stall \$....

Boxing and cartage will be charged at cost.

Can furnish any number of stalls as above described; and the height and depth of stalls may be varied to suit conditions.

In Orders and Specifications give Plate Numbers and Number of Stalls.

URINAL STALLS.

WITH AUTOMATIC FLUSHING TANKS.

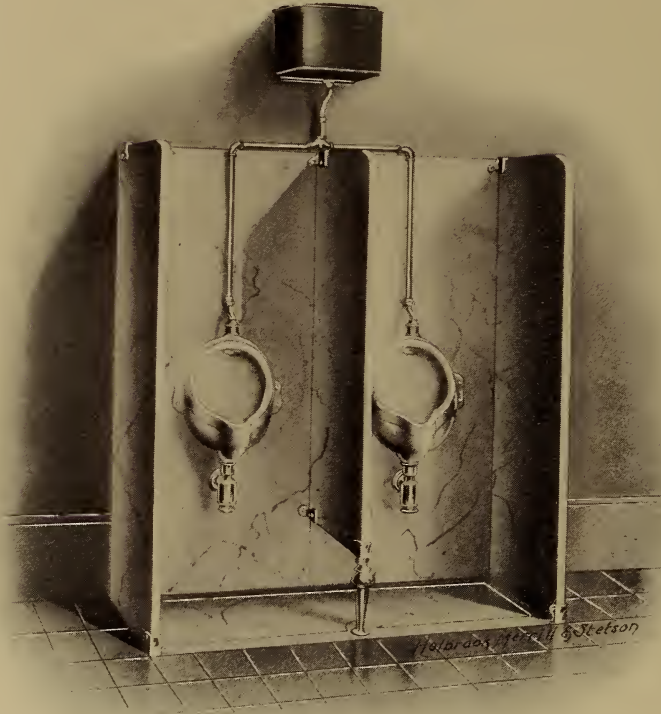

421-C.

Two-Stall Italian Marble Urinal with 7/8-inch Italian Marble Ends and Partition, polished on both sides, 7/8-inch Italian Marble Back polished one side, and 1 1/2-inch Counter Sunk Base; Nickel-Plated Brass Clamps and Bolts; Nickel-Plated Brass Inlet Connections; two No. 2 Flat Back Porcelain Lipped Urinals; Nickel-Plated Brass Urinal Traps; Nickel-Plated Brass Leg for Partition; two-gallon Oak Automatic Flushing Tank, with Patent Tank Board and Nickel-Plated Brass Flush Pipes to Urinal.

Waste Plugs or Strainers furnished at extra cost.

Dimensions :

Height, 5 feet; center to center of partitions, 2 feet; depth, 20 inches; height of leg, 12 inches.

	Parcour Pardoca	Pardaco Pardonner	Pardalia Pardosena	Pardante Pardulph	Pardauz Pardusco	Pardillo Pareage
Code for Marble						
Code for Slate.....						
Number of Stalls.....	1	2	3	4	5	6
Capacity of Tank, gallons	1	2	2	3	3	4
Marble complete as described.....	\$99.75	174.25	253.50	332.20	412.40	491.20
Slate complete as described.....	95.30	161.15	232.40	303.15	375.40	446.20
Shipping weight complete, lbs.	588	996	1407	1815	2231	2640

Price for above Stalls in Tennessee Marble same as for Italian Marble.
 If with Polished Brass Clamps, Bolts, Connections, Traps, Legs and Pipes, deduct for each Stall \$1.50.
 Boxing and cartage will be charged at cost.
 Can furnish any number of stalls as above described; and the height and depth of stalls may be varied to suit conditions. Prices on application.

In Orders and Specifications give Plate Numbers and Number of Stalls.

URINAL STALLS.

WITH DOHERTY SELF-CLOSING URINAL COCKS.

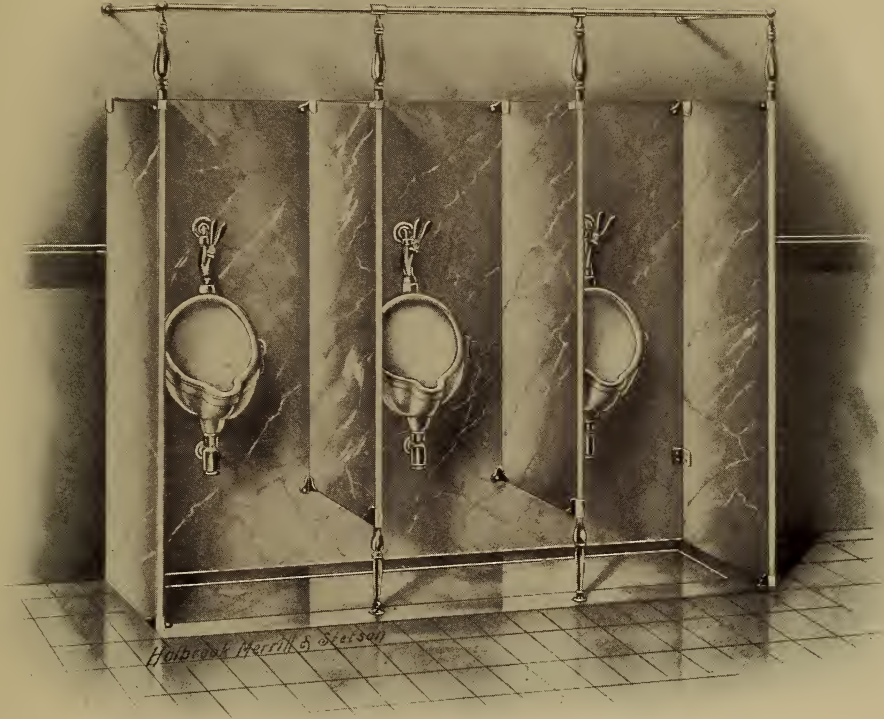

423-C.

Three Stall Italian Marble Urinal with 7/8-inch Italian Marble Ends and Partitions polished on both sides; 7/8-inch Italian Marble Back polished one side and 1 1/2-inch Counter Sunk Italian Marble Base; Nickel-Plated Brass Clamps and Bolts; Nickel-Plated Top Railing and Legs with Bolts; three No. 2 Flat Back Porcelain Lipped Urinals, with Nickel-Plated Doherty Self-Closing Urinal Cocks and Connections and Nickel-Plated Urinal Traps.

Waste Plugs or Strainers furnished at extra cost.

Dimensions:

Height without railing, 5 feet; with railing, 6 feet; center to center of partitions, 2 feet; depth, 20 inches; height of leg, 12 inches; base, 2 feet wide.

Code for Marble.....	Parechem	Parecimo	Paredros	Pareglio	Parelcon	Parelgras
Code for Slate.....	Parelion	Parelkust	Parelmos	Parelzout	Parembol	Paremia
Number of Stalls.....	1	2	3	4	5	6
Price for Marble as described.....	\$111.15	200.75	300.90	390.50	480.10	569.75
Price for Slate as described	98.40	176.60	266.60	344.80	423.00	501.25
Shipping weight complete, lbs.....	575	988	1401	1814	2227	2640

Price for above Stalls in Tennessee Marble same as for Italian.
 If with Polished Brass Trimmings instead of Nickel-Plated, deduct for each Stall \$1.90.
 Boxing and cartage will be charged at cost.
 Can furnish any number of Stalls as above described, and the height and depth of Stalls may be varied to suit conditions. Prices on application.

In Orders and Specifications give Plate Numbers and Number of Stalls.

URINAL STALLS.

WITH AUTOMATIC FLUSHING TANKS.

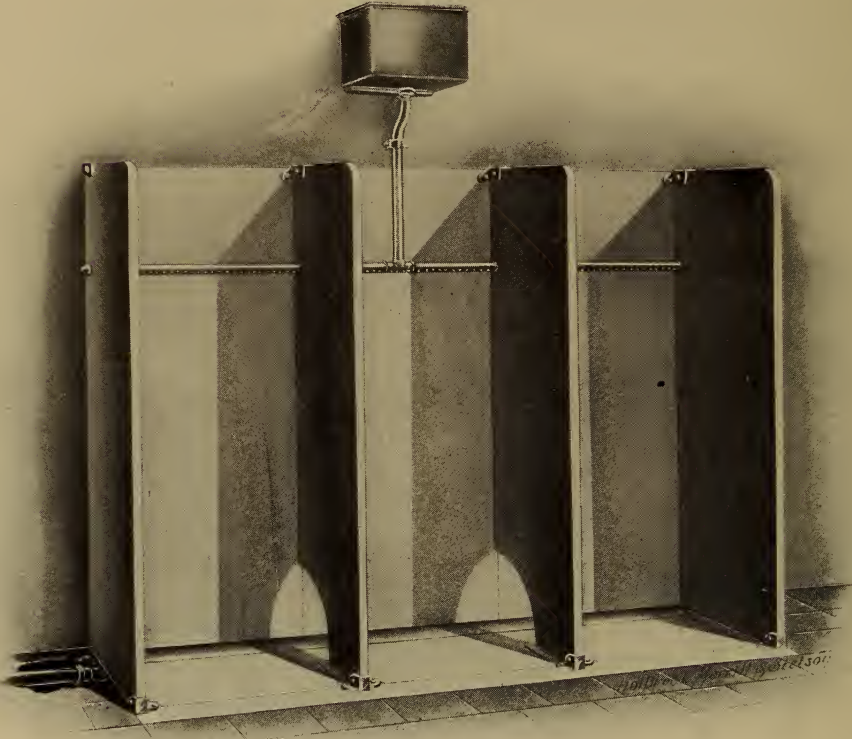

425-C.

Three-Stall Slate Urinal with Cast Iron Galvanized Gutter, Strainer and Outlet; Polished Brass Clamps and Bolts; Perforated Brass Wash Down Pipe; two gallon Oak Automatic Flushing Tank with Patent Tank Board and Polished Brass Flush Pipe.

Dimensions:

Height, 5 feet; center to center of partitions, 24 inches; depth, 20 inches; base, 24 inches wide Ends, backs and partitions are $\frac{7}{8}$ inch thick; base is $1\frac{1}{2}$ inches thick.

Code for Slate.....	Parentage	Parental	Parentesi	Parentese	Parentless	Parfait
Code for Marble.....	Parfilage	Parfondon	Parfum	Pargasite	Pargeter	Pargolo
Number of Stalls.....	1	2	3	4	5	6
Price for Slate as described.....	\$ 98.40	151.50	218.10	271.90	327.20	389.80
Price for Marble as described.....	114.10	181.20	254.70	322.50	391.80	468.40
Shipping weight, lbs.....	565	1070	1377	1782	2195	2600

Price for above Stalls in Tennessee Marble same as for Italian.

Can furnish any number of Stalls as above described, and the height and depth of Stalls may be varied to suit conditions.

With Nickel-Plated Brass Trimmings, add for each Stall \$1.20.

Above Stalls can be furnished either right or left hand outlet. Left hand outlet, as shown in cut, is always sent unless otherwise specified.

Boxing and cartage will be charged at cost.

In Orders and Specifications give Plate Numbers and Number of Stalls.

URINAL STALLS.

WITH WASH DOWN PIPE.

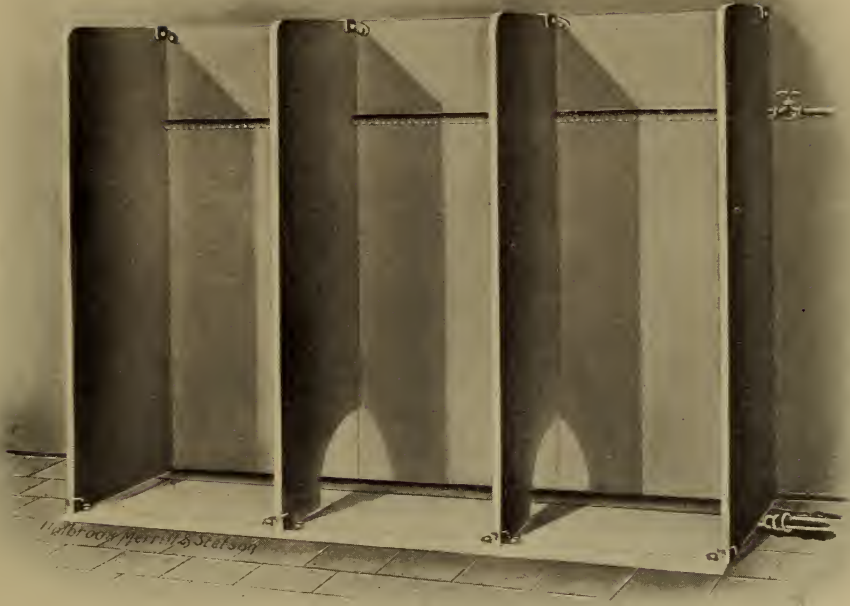

427-C.

Three Stall Slate Urinal with Cast Iron Galvanized Gutter, Strainer and Outlet Connection; Polished Brass Clamps and Bolts; Perforated Brass Wash Down Pipe with Finished Brass Compression Loose Key Stop.

Dimensions:

Height, 5 feet; center to center of partitions, 2 feet; depth, 20 inches; base, 24 inches wide. Ends, backs and partitions, $\frac{3}{8}$ inch thick; base, $1\frac{1}{2}$ inches thick.

Code for Slate.....	Parhippi	Pariade	Pariambo	Pariamus	Parianos	Parjura	Parjurons
Code for Marble.....	Parkart	Parladill	Parladora	Parlagio	Parlantin	Parlassi	Parlatura
Number of Stalls.....	1	2	3	4	5	6	7
Price for Slate as described....	\$ 91.20	144.40	210.10	263.30	316.50	378.50	431.70
Price for Marble as described..	106.90	174.10	246.70	313.90	381.10	457.10	524.30
Shipping weight, lbs.....	540	945	1350	1755	2160	2565	2970

These Stalls can be furnished in any length, height and depth; single, as shown, to go against the wall; or double with back in center having Stall on each side and Tank suspended from ceiling.

Price for above in Tennessee Marble, same as for Italian Marble.

If with Nickel-Plated Brass Trimmings for each Stall, add \$1.00.

Can furnish any number of Stalls as above described, and the height and depth of Stalls may be varied to suit conditions. Prices on application.

Boxing and cartage will be charged at cost.

Above Stalls can be furnished either right or left hand outlet; right hand outlet as shown in cut is always sent unless otherwise specified.

In Orders and Specifications give Plate Numbers and Number of Stalls.

URINAL STALLS.

FOR SCHOOLS AND PUBLIC BUILDINGS. WITH WASH DOWN PIPE.



429-C.

Slate Urinal Stall with Cast Iron Galvanized Gutter, Strainer and Outlet Connection; Brass Clamps and Bolts; Perforated Brass Wash Down Pipe, with Finished Brass Compression Loose Key Stop.

Dimensions:

Height, 5 feet; depth, 20 inches; Back and Ends are of 7/8-inch Slate or Marble; the Base is 1 1/2 inches thick.

Code for Slate.....	Parlement	Parleront	Parleurs	Parlevole	Parlolean
Code for Marble	Parmacell	Parmain	Parmatos	Parmenon	Parmesan
Length, feet.....	4	6	8	10	12
Price for Slate complete, as described,....	\$ 96.30	135.50	166.70	197.90	237.90
Price for Marble complete, as described..	121.10	164.10	198.95	233.90	277.60
Shipping weight, lbs.....	742	976	1200	1434	1668

This Stall can be furnished in any length, height and depth. Single, as shown, to go against the wall, or double with back in center and Stall on each side.

Prices for above in Tennessee Marble same as for Italian Marble.

Boxing and cartage will be charged at cost.

Can furnish any length of Stall as above described, and the height and depth may be varied to suit conditions. Prices on application.

Can be furnished either right or left hand outlet; left hand outlet, as shown, will always be sent unless otherwise specified.

In Orders and Specifications give Plate Numbers and Length.

GLASS URINAL STALLS.

WITH WASH DOWN PIPE.

**431-C.**

Three Stall Rough Rolled Glass Urinal; the Back, Ends and Partitions are of 1-inch Rough Rolled Glass, all exposed edges are polished; Nickel-Plated Brass Clamps and Bolts; Nickel-Plated Brass, Perforated Wash Down Pipe with Nickel-Plated Compression Loose Key Stop; Cast Iron Galvanized Gutter with Straight Outlet Connection.

Dimensions:

Height, 5 feet; width, center to center of partitions, 2 feet; depth, 20 inches.

Code.....	Parnassi	Parnopes	Parobsis	Parochete	Parochian
Number of Stalls.....	1	2	3	4	5
Price as described	\$121.20	194.40	276.40	349.60	422.80
Shipping weight, lbs.....	630	1085	1540	1995	2450

The bottom parts of Ends and Partitions are made so that the Glass Base can be pitched toward the Gutter. Glass being non-absorbent is well adapted for Urinal Stalls.

We can furnish Glass Urinal Stalls fitted up with Earthenware Urinals, or in any other manner or size desired.

Prices on application.

Above Stalls can be furnished either right or left hand outlet; left hand outlet, as shown in cut, will always be sent unless otherwise specified.

Boxing and cartage will be charged at cost.

In Orders and Specifications give Plate Numbers and Number of Stalls.

SPEAKMAN'S VENTILATED URINALS.

FOR SCHOOLS AND PUBLIC BUILDINGS.

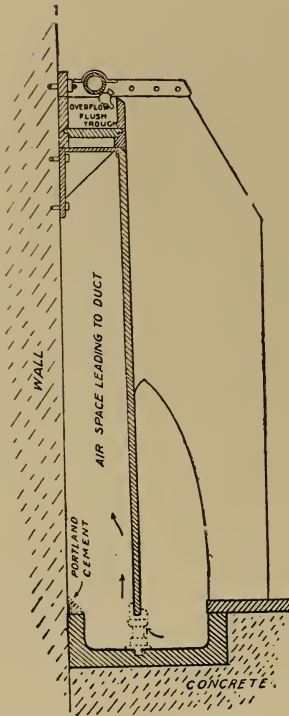

433-C.

Single Partition to set against wall.

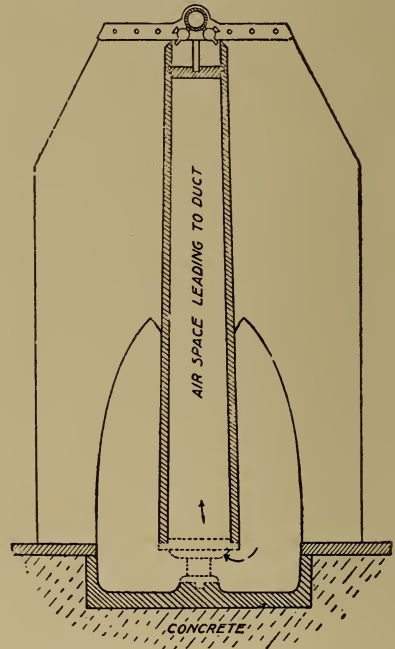

434-C.

Double Partition to set in room and away from wall.

Sectional views of Ventilated Urinals, 435-C and 436-C, showing details of Flushing Cistern, Ventilating Duct and Waste Trough.

This is absolutely a sanitary fixture; the water for flushing the urinal is fed into the slate cisterns through the pet cocks, which economizes the consumption of water to the last degree.

The water overflows from the cisterns through the grooves at upper edge of back and forms a perfect and continuous sheet on the urinal backs and falls into the slate waste trough below. By using the standing overflow in the slate waste trough, a body of water 2 inches deep is carried in it, and so dilutes the urine that the whole fixture is kept free from odor.

The urinal is efficiently ventilated by having an air duct between the backs, as shown in the double pattern, and between the back and wall in the single pattern, and a draught can be created by placing a gas jet in the copper flue attached at the end, or the fixture can be placed on a fan system, or connected with a hot air flue or chimney. All odors are drawn up from the waste trough, then pass between the backs and out into the flue; thus ventilating not only the urinal, but the entire room in which it is located.

When a gas jet is placed in the copper flue, a very small flame only is required to create the necessary draught.

In Orders and Specifications give Plate Numbers.

SPEAKMAN'S VENTILATED URINALS.

FOR SCHOOLS AND PUBLIC BUILDINGS.

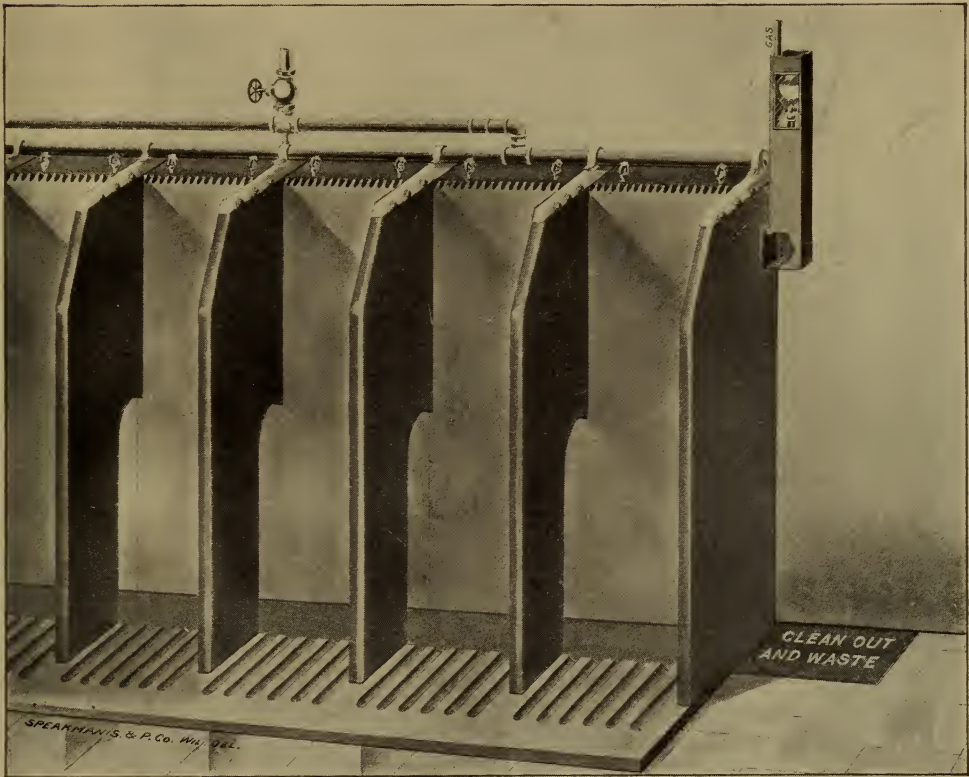
**435-C.**

Ventilated Slate Urinal with Partitions, Back, Countersunk Floor Slabs, Slate Flushing Cisterns, Solid Slate Waste Trough extending under Slate Cover at end and provided with 3-inch Polished Brass Removable Standing Overflow and additional End Overflow; Polished and Nickel-Plated Partition Caps and Supply Pipe Holders; 1¼-inch Galvanized Iron Supply Pipe with Brass Pet Cocks with Special Heads (so that they cannot be tampered with); Brass Supporting Legs, Heavy Iron Cistern Supports and Bolts; no Knees or Bolts required in the setting of Partitions, therefore lessening the number of places to hold filth.

Code.....	Parodiam	Parodical	Parody	Paroffia	Parpado	Parpalla	Parpallota	Parpatana
Number of Stalls.....	3	4	5	6	7	8	9	10
Complete, as described..	\$176.00	235.00	293.00	352.00	411.00	469.00	528.00	581.00
Shipping weight, lbs.....	1230	1595	1960	2325	2690	3055	3420	3785

Copper Vent Flue and Main Supply Valve not included in above prices.

In ordering, state whether right or left hand outlet is required. We invariably send Urinal with outlet on right hand side, as shown in 435-C, unless otherwise specified.

Dimensions:

Height, 5 feet; width, 21 inches between partitions; depth, end partitions, 20⅝ inches; middle partitions, 14 inches; width of floor slabs, 15 inches; distance from front of base to wall, 28⅝ inches; back, 1 inch thick; partitions, 1 inch thick; floor slab, 2 inches thick; slate waste trough, 12 inches wide inside and 4 inches deep inside.

For further details see page 124.

In Orders and Specifications give Plate Numbers and Number of Stalls.

SPEAKMAN'S DOUBLE VENTILATED URINALS.

FOR SCHOOLS AND PUBLIC BUILDINGS.

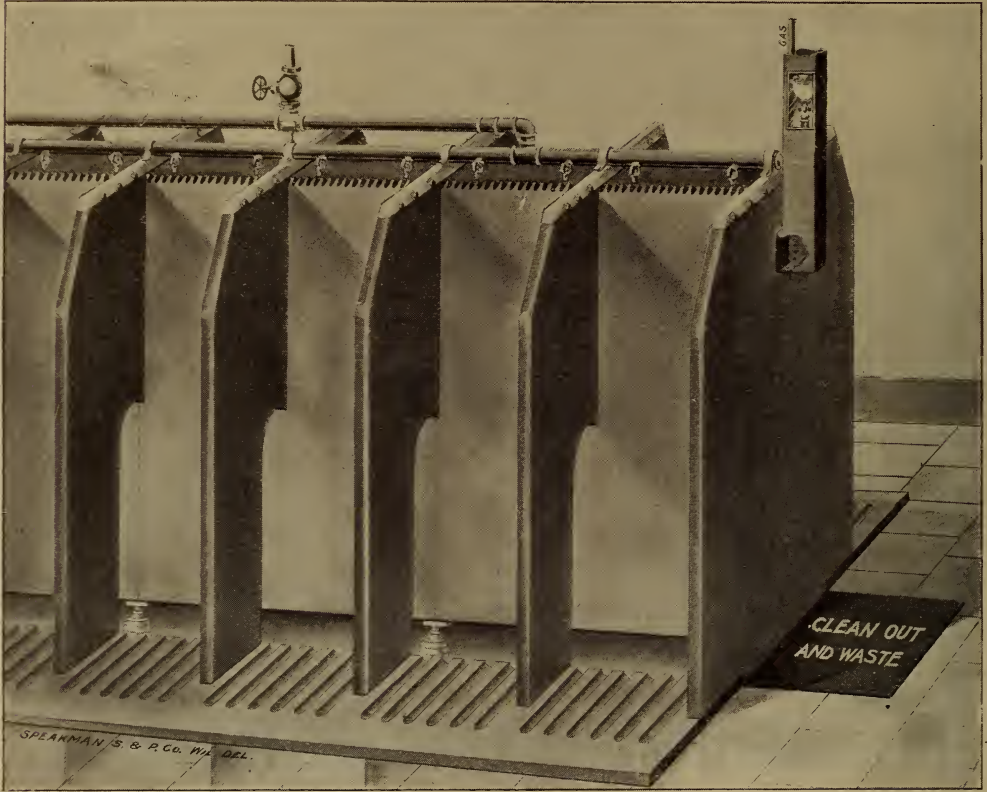

436-C.

Double Ventilated Slate Urinal with Partitions, Backs, Countersunk Floor Slabs, Slate Flushing Cisterns, Slate Waste Trough extending under Slate Cover at end, and provided with 3-inch Polished Brass Removable Standing Overflow and additional End Overflow; Galvanized Iron Pedestals for supporting the Backs; Polished and Nickel-Plated Brass Partition Caps and Supply Pipe Holders; 2-inch Galvanized Iron Supply Pipe with Brass Pet Cocks with Special Heads (so that they cannot be tampered with); no Knees or Bolts required in the setting of Partitions, therefore lessening the number of places to hold filth.

Code.....	Parqueda	Parquet	Parrafo	Parrains	Parrudo	Parsemer	Parsimus	Parsisset
Number of Double Stalls....	3	4	5	6	7	8	9	10
Complete, as described.....	\$370.00	423.00	528.00	633.00	740.00	839.00	939.00	1027.00
Shipping weight, lbs.....	1730	2460	3190	3920	4650	5380	6110	6840

Copper Vent Flue and Main Supply Valve not included in above prices.

In ordering, state whether right or left hand outlet is required. We invariably send Urinal with outlet on right hand side, as shown in 436-C, unless otherwise specified.

Dimensions:

Height, 5 feet; width, 21 inches between partitions; depth, end partitions, 35¼ inches; middle partitions, 14 inches; width of floor slabs, 15 inches; width over all, 49¾ inches; back, 1 inch thick; partitions, 1 inch thick; floor slabs, 2 inches thick; width of gutter, 20¼ inches inside; depth, 4 inches inside.

For further details see page 124.

In Orders and Specifications give Plate Numbers and Number of Stalls.

IDEAL PORCELAIN URINALS.



440-C.

441-C.
Sectional.

These Urinals may be set on floor, in tile, incased in Marble or Slate Stalls, as shown in 441-C above. Each Urinal is made with Local Vent opening, 2x4 inches at top as shown.

Code.....	Parsnip
Urinal only.....	\$67.00
Shipping weight, lbs.....	450
Shipping measurement, cubic feet.....	28

For Nickel-Plated Flush Connection and Spreader, add \$14.00.

For Nickel-Plated Strainer and Floor Flange, add \$5.50.

Dimensions:

Height over all, Urinal only, 4 feet; width over all, 2 feet; base, from front to rear, 19 inches; at top, from front to rear, 12 inches; thickness, 1 3/4 inches; distance from center of outlet to back 12 inches; outlet, 3 1/2 inches, countersunk 4 1/2 inches diameter and 3/4 inch deep.

In Orders and Specifications give Plate Numbers.

IDEAL PORCELAIN URINALS.



442-C.

Two Ideal Porcelain Urinals with Flat Tops, Front Pieces and Ideal Porcelain Floor Slabs.

Code.....	Parsoleta	Parsonic	Parsuros	Partage	Partaking
Number of Urinals.....	1	2	3	4	5
Price as described	\$100.00	187.00	273.00	360.00	447.00
Shipping weight, lbs.....	800	1400	2000	2600	3200

Tank and Flush Pipe not included in above prices.

For Nickel-Plated Flush Connection and Spreader, add \$14.00 for each Urinal.

For Nickel-Plated Strainer and Floor Flange, add \$5.50 for each Urinal.

Height from floor to top over all, 3 feet 7 inches; for other measurements see page 127.
 Each Urinal is provided with a 2x4 local vent, as shown by sectional view 441-C.

In Orders and Specifications give Plate Numbers and Number of Urinals.

AUTOMATIC SIPHON EDUCATION PUBLIC URINALS.

SECTIONAL VIEW.

(Patented.)

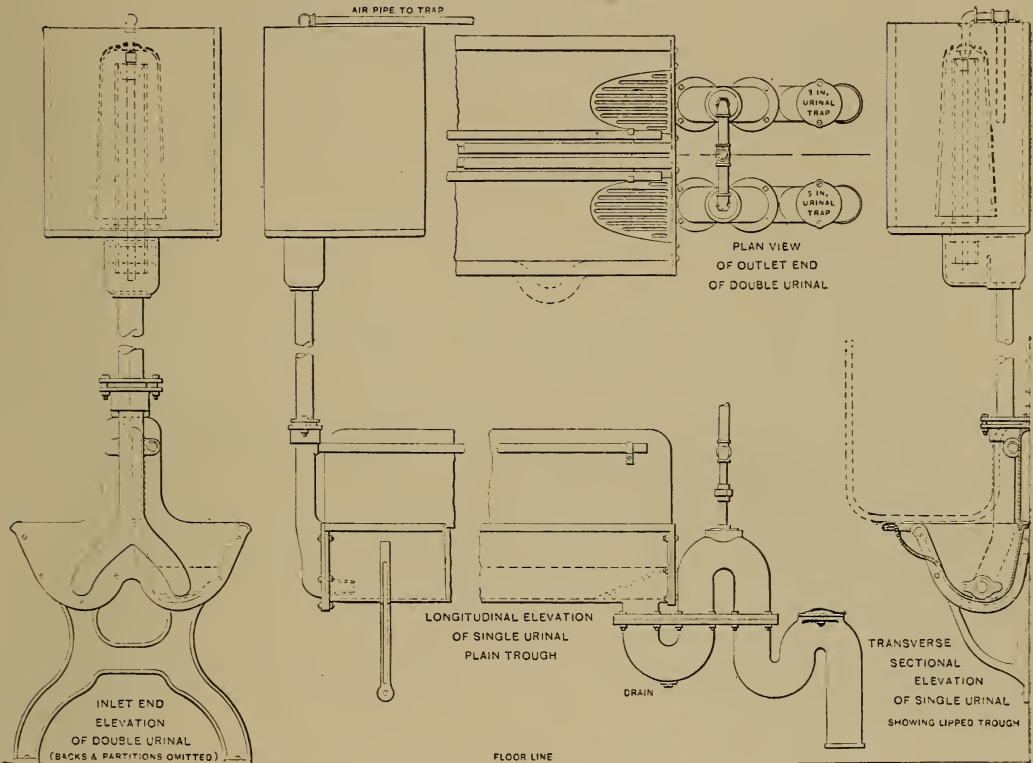
**446.C.**

An accurate knowledge of the relative position of parts of both single and double fixture with either Plain or Lipped Troughs, will be gained by reference to the above drawings.

Full instructions for erecting and operating are furnished with each fixture.

Blue prints giving detailed dimensions of every part of complete fixture and all information essential to "roughing-in," will be sent on request.

The absence of movable parts in this Urinal is a strong point, because there is no likelihood of such a fixture getting out of order. The depth of water in these Urinals, 4 inches, is commendable and necessary from a sanitary point of view, as the large volume of water so greatly dilutes the urine that no offensive odors arise from it. The Urinal back is flushed and cleansed at intervals by a strong flow of water through the perforated pipe.

The interval of time between flushes is entirely controlled by the flow of water to the tank through the supply pipe, and may be easily regulated to act with any interval of time between flushes desired. The outlet siphon is well trapped and has a large opening which affords an easy passage for uncertain quantities of unclassified filth dropped into receptacles of this class.

Dimensions:

These Urinals are made regularly from 4 to 16 feet long, as shown, and with lipped trough, each size being 1 foot longer than the next shorter length, but can be made any length, or more than 16 feet, if desired. The inlet and outlet siphon add 1 foot 3 inches to length over all, making a 4-foot Urinal 5 feet 3 inches long from end of inlet at flush pipe to outer edge of siphon outlet. The Urinals are 9 inches from front to back, inside; 12 inches front to back outside; 8 inches deep inside; 20½ inches from floor to front of Urinal; and 30 inches from floor to top of back; from back wall to center of outlet, 6 inches; size of outlet, 3 inches. For weights, see page 136.

In Orders and Specifications give Plate Numbers and Sizes.

AUTOMATIC SIPHON EDUCATION PUBLIC URINALS.

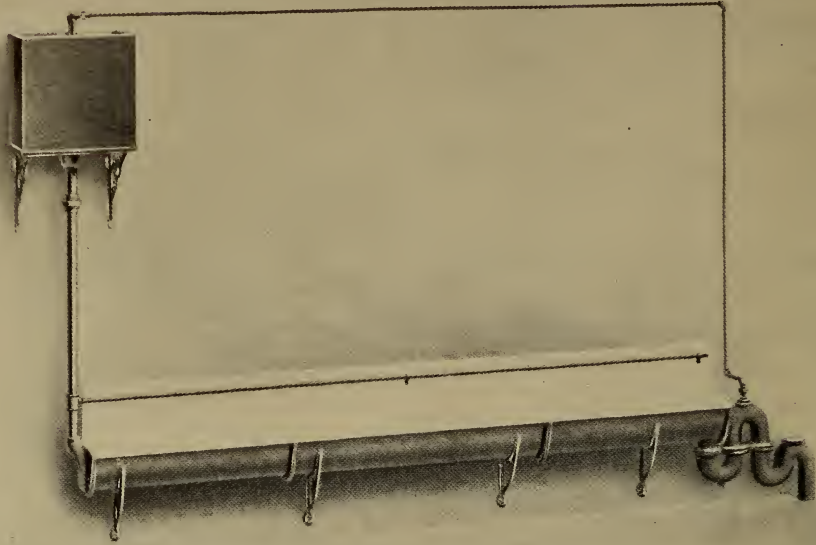

448-C.

Cut shows Plain Trough with Siphon Education Copper-Lined Wood Tank and Galvanized Iron Flush Pipe. Perforated Wash-Down Pipe fitted along Back (Brass on Enameled and Galvanized Iron on Painted Urinals).

Length of Urinal, Feet.	Length Over All,		Painted.				Enameled.			
	Ft.	In.	Code.	As Shown.	Code.	With Lipped Trough.	Code.	As Shown.	Code.	With Lipped Trough.
4	5	3	Partitudo	\$ 45.00	Parumper	\$ 49.00	Parvoice	\$ 70.00	Pasamano	\$ 76.00
5	6	3	Partitura	50.00	Parusia	55.00	Parvoline	80.00	Pasapan	87.50
6	7	3	Partivano	55.00	Parvaleza	61.00	Parvulez	90.00	Pasaporte	99.00
7	8	3	Partivit	60.00	Parvedade	67.00	Parygros	100.00	Pasaste	110.50
8	9	3	Partons	65.00	Parvenon	73.00	Parygrum	110.00	Pasaturo	122.00
9	10	3	Partout	70.00	Parvicolle	79.00	Parzival	120.00	Pascale	133.50
10	11	3	Partualis	75.00	Parvifica	85.00	Pasacalle	130.00	Pascaline	145.00
11	12	3	Partules	80.00	Parviflore	91.00	Pasadera	140.00	Pascamus	156.50
12	13	3	Paruisti	85.00	Parvitas	97.00	Pasadillo	150.00	Pascentum	168.00

Longer lengths can be furnished. Prices on application.

Painted Cast Iron Tanks can be furnished if desired, without extra charge.

Lead-Lined Tanks can be furnished to order. Prices on application.

Also made with Lipped Trough, as shown in Plate 450-C. Urinals with Lipped Troughs are otherwise the same as Plate 448-C.

The outlet is always securely trapped; the depth of water is always 4 inches, except just previous to siphoning, when it is raised to six inches; there are no movable parts, therefore most unlikely to need repairs.

Unless otherwise ordered, Urinals with Enameled interior and Outlet on right end, as shown, will be sent.

For approximate weight of above, see page 136. For dimensions and details, see page 129.

In Orders and Specifications give Plate Numbers and Sizes.

AUTOMATIC SIPHON EDUCATION LIPPED PUBLIC URINALS.

FITTED WITH PARTITIONS.

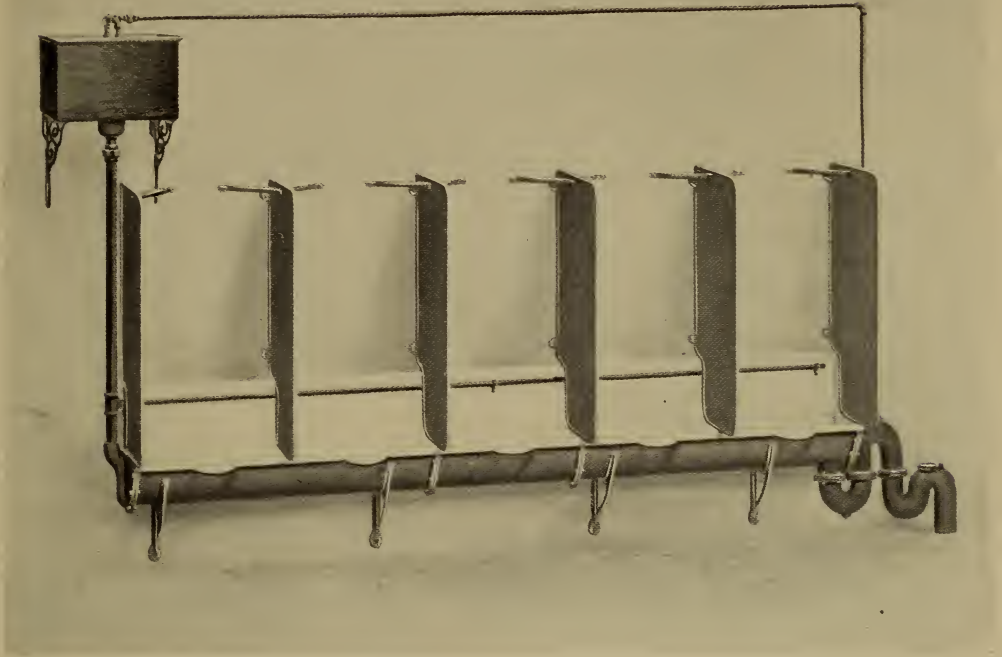

450-C.

Cut shows Lipped Trough with Siphon Education Copper-Lined Wood Tank, Galvanized Iron Flush Pipe and Painted Iron Partitions, 24 inches apart. Perforated Wash-down Pipe fitted along back (Brass on Enameled and Galvanized Iron on Painted Urinals).

Length of Urinal, Feet.	Partitions, Number of	Painted.				Enameled.			
		Code.	With Plain Trough.	Code.	As Shown.	Code.	With Plain Trough.	Code.	As Shown.
4	3	Paschalis	\$ 60.00	Pashaws	\$ 64.00	Pasmaat	\$ 85.00	Passacorde	\$ 91.00
6	4	Paschite	75.00	Pasilaly	81.00	Pasmaban	110.00	Passadez	119.00
8	5	Pascoland	90.00	Pasiones	98.00	Pasmado	135.00	Passaport	147.00
10	6	Pascolava	105.00	Pasiteles	115.00	Pasmunt	160.00	Passarola	175.00
12	7	Pascuant	120.00	Pasithea	132.00	Paspales	185.00	Passation	203.00
14	8	Pasgang	135.00	Pasitrote	149.00	Pasquill	210.00	Passavoga	231.00

Longer Urinals can be furnished. Prices on application.

Also made with Plain Trough as shown in Plate 448-C. Urinals with Plain Troughs are otherwise the same as Plate 450-C.

Painted Cast Iron Tanks can be furnished, if desired, without extra charge. Lead-Lined Tanks can be furnished to order. (Prices on application.)

The Urinal illustrated on this page is 10 feet long, fitted with 6 partitions placed 2 feet apart. Partitions may be placed to suit purchaser.

For directions for setting and operating, statement of merits, etc., of these Urinals see page 129.

Unless otherwise ordered, Urinals with Enameled Interior and Outlet on right end, as shown, will be sent.

For approximate weight of above, see page 136.

In Orders and Specifications Give Plate Numbers and Sizes.

AUTOMATIC SIPHON EDUCATION DOUBLE PUBLIC URINALS.

FITTED WITH PARTITIONS.

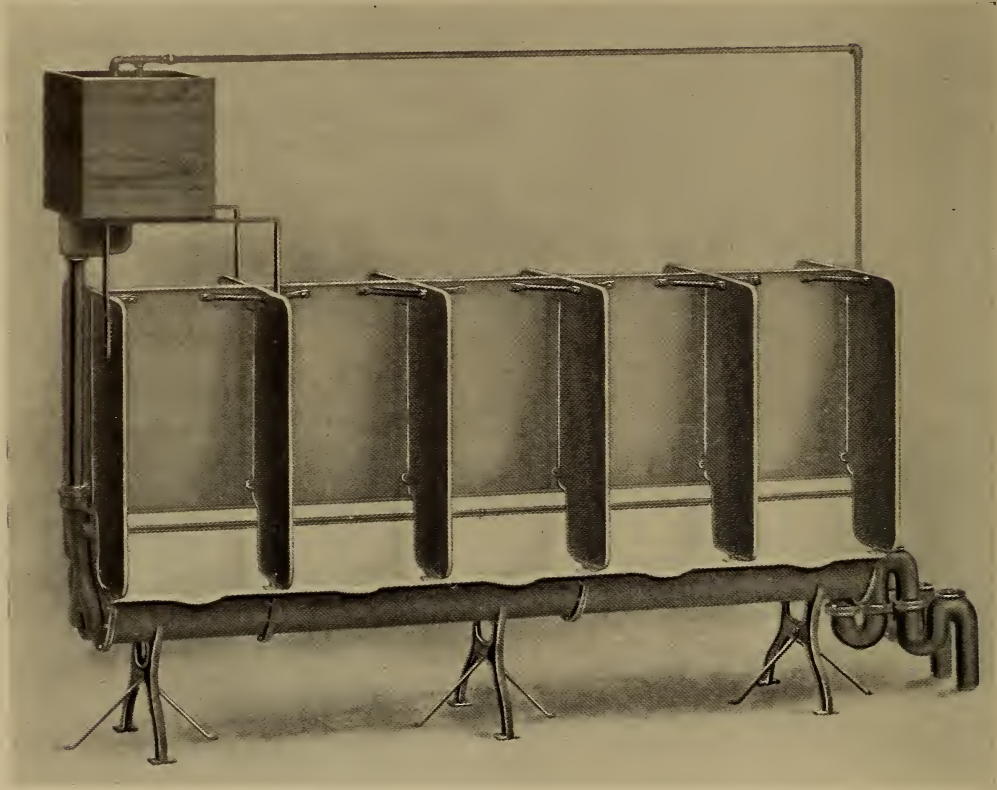

450½-C.

Cut shows Lipped Trough with Siphon Education Copper-Lined Wood Tank, Galvanized Iron Flush Pipe, Painted Iron Partitions, 24 inches apart, and Backs. Perforated Wash-Down Pipes fitted along Backs (Brass on Enameled and Galvanized Iron on Painted Urinals).

Length of Urinal, Feet.	Partition, Number of.	Painted.				Enameled.			
		Code.	With Plain Trough.	Code.	As Shown.	Code.	With Plain Trough.	Code.	As Shown.
4	6	Passefog ...	\$130.00	Passefuel...	\$138.00	Passefurz...	\$180.00	Passegoul..	\$192.00
6	8	Passefoll...	165.00	Passefuge..	177.00	Passefuted.	235.00	Passehad...	253.00
8	10	Passefoltz...	200.00	Passefull...	216.00	Passefux ...	290.00	Passehurt...	314.00
10	12	Passefome.	235.00	Passefull...	255.00	Passefuze...	345.00	Passejurz...	375.00
12	14	Passefort...	270.00	Passefume.	294.00	Passegam ..	400.00	Passekurl...	436.00
14	16	Passefotte..	305.00	Passefunny	333.00	Passegorg...	455.00	Passeloze ..	497.00
16	18	Passefoxes	340.00	Passefupat	372.00	Passegatt...	510.00	Passemux..	558.00

Painted Cast Iron Tanks can be furnished, if desired, without extra charge. Lead-Lined Tanks can be furnished to order. (Prices on application.)

Unless otherwise ordered, Urinal with Enameled Interior and Lipped Trough, as shown, will be sent.

Sectional view of Urinals are shown on page 129

For approximate weights of above, see page 136.

In Orders and Specifications give Plate Numbers and Sizes.

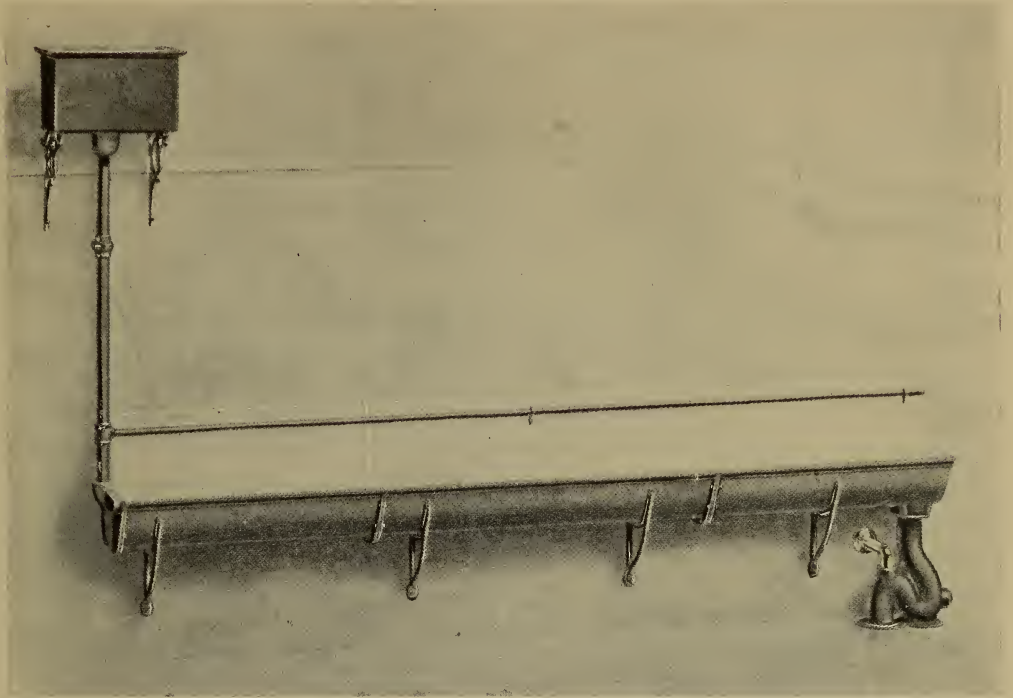
AUTOMATIC WASHOUT PUBLIC URINALS.**451-C.**

With Automatic Copper-Lined Wood Tank and Galvanized Iron Flush Pipe. Perforated Wash-Down Pipes fitted along Back and Front of Urinal (Brass or Galvanized on Enameled and Galvanized on Painted Urinals, as listed below) and with heavy Brass Capping along Front.

Length of Urinal, Feet.	With Galvanized Pipe.				With Brass Pipe.	
	Painted.		Enameled.		Enameled.	
	Code.	Price.	Code.	Price.	Code.	Price.
5	Passende	\$ 50.00	Passitare	\$ 70.00	Pastelone	\$ 75.00
6	Passerage	55.00	Passivita	78.00	Pastenade	85.00
7	Passerino	60.00	Passless	86.00	Pasterma	95.00
8	Passform	65.00	Passonata	94.00	Pastiglia	105.00
10	Passifs	75.00	Passrecht	110.00	Pastinaca	125.00
12	Passinho	85.00	Passworte	126.00	Pastisson	145.00
14	Passiolo	95.00	Pastagem	142.00	Pastorage	165.00
16	Passional	105.00	Pastelier	158.00	Pastorally	185.00

A dam near the outlet preserves a bed of water in the bottom of the Urinal Trough, and at each flushing the back and sides are thoroughly cleansed, in addition to the strong washout flush from the flush pipe end, which acts in the same way as that of a washout closet range.

Painted Cast Iron Tanks can be furnished, if desired, without extra charge. Lead-Lined Tanks can be furnished to order. (Prices on application.)

Trap standard enameled inside is furnished with enameled Urinals.

If trap standard is not wanted, deduct \$5.00 for enameled and \$4.25 for painted from lists.

If painted trap standard is wanted for enameled Urinal, deduct \$0.75 from list.

Dimensions:

The lengths of Urinals are exactly as given in list above. When set as shown, the end of cleanout on trap standard extends 4 inches beyond the end of Urinal, which must be allowed for when roughing-in.

Height from floor to top of rim in front, 26 inches; height from floor to top of back, 36 inches; depth inside, 7½ inches; width inside, 9 inches; width, front to back, 12 inches, with trap set as shown; from wall to center of outlet, 5 inches; end of Urinal to center of outlet, 7½ inches; from floor to center of vent, 10¾ inches; diameter of outlet, 3 inches.

Unless otherwise ordered, Urinal with Enameled Interior, with Brass Wash-Down Pipes and Outlet on right End, as shown, will be sent.

For approximate weights of above, see page 136.

In Orders and Specifications give Plate Numbers and Sizes.

AUTOMATIC WASHOUT PUBLIC URINALS.

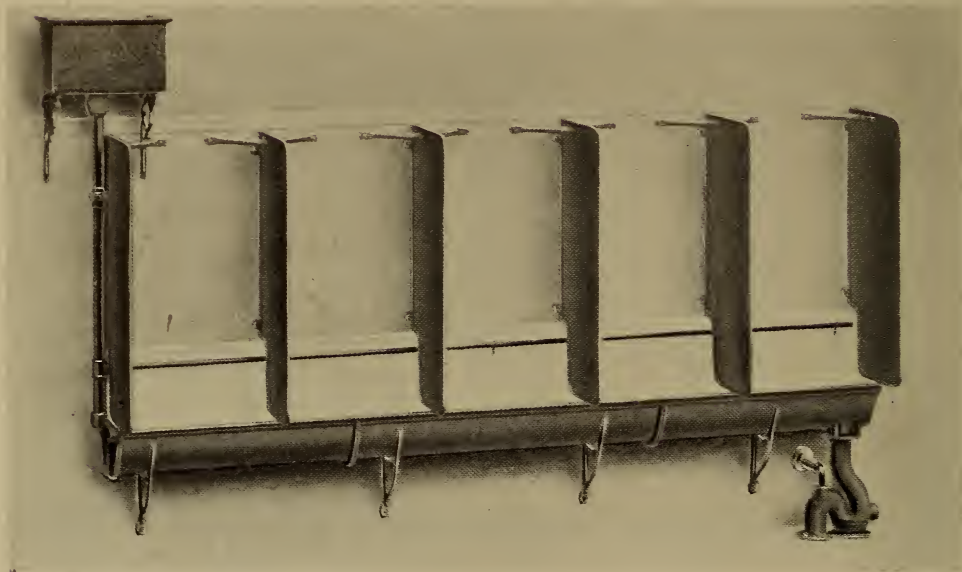

452-C.

With Automatic Copper-Lined Wood Tank, Galvanized Iron Flush Pipe and Painted Iron Partitions, 24 inches apart. Perforated Wash-Down Pipes fitted along Back and Front of Urinal (Brass or Galvanized on Enameled and Galvanized on Painted Urinals, as listed below) and with Heavy Brass Capping along Front.

Length of Urinal, Feet.	Partition, Number of.	With Galvanized Pipe.				With Brass Pipe.	
		Painted.		Enameled.		Enameled.	
		Code.	Price.	Code.	Price.	Code.	Price.
6	4	Pastorise	\$ 75.00	Pastufade	\$ 98.00	Pasturer.....	\$105.00
8	5	Pastority	90.00	Pastulla.....	119.00	Pastvell.....	130.00
10	6	Pastuare	105.00	Pastumn	140.00	Pastwurt	155.00
12	7	Pastube ..	120.00	Pastunot	161.00	Pataba	180.00
14	8	Pastuck	135.00	Pastupole	182.00	Pataburt	205.00
16	9	Pastude.....	150.00	Pastupun.....	203.00	Patabuzz	230.00

Trap Standard, Enameled Inside is furnished with Enameled Urinals.

If Trap Standard is not wanted, deduct \$5.00 for Enameled and \$4.25 for Painted from lists. Brass Flush Pipe can be furnished if desired. (Prices on application.)

Painted Cast Iron Tanks can be furnished, if desired, without extra charge. Lead-Lined Tanks can be furnished to order. (Prices on application.)

Unless otherwise ordered, Urinal with Enameled Interior, with Brass Wash-Down Pipes and Outlet on right end, as shown, will be sent.

For dimensions, see page 133.

For approximate weights, see page 136.

In Orders and Specifications give Plate Numbers and Sizes.

CAST IRON ROLL RIM PUBLIC URINALS.

WITH BACK, BRASS BEEHIVE STRAINER, PERFORATED FLUSH PIPE AND LOOSE KEY STOP $\frac{1}{2}$ -INCH IRON PIPE SIZE AND NICKEL-PLATED VENTED "P" TRAP.

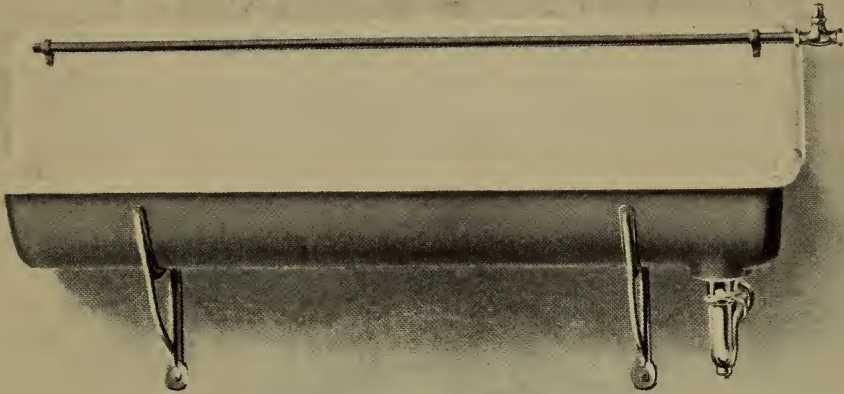

455-C without Flush Pipe. 457-C as shown.

Length of Urinal, Feet.	Painted. With Galvanized Wash-Down Pipe.		Deduct for Galvanized Wash-Down Pipe and Stop.	Enameled. With Brass Wash-Down Pipe.		Deduct for Brass Wash-Down Pipe and Stop.
	Code.	Price.		Code.	Price.	
2	Paterniser	\$17.25	\$ 3.50	Patoisant	\$21.25	\$ 5.00
2½	Patersonic	18.25	4.00	Patologos	23.50	5.75
3	Patescunt	19.50	4.25	Patraque	25.75	6.50
3½	Pathans	21.00	4.75	Patricia	28.00	7.25
4	Pathetico	22.25	5.00	Patricide	30.25	8.00
5	Pathflies	25.00	5.75	Patricoles	36.25	9.50
6	Pathicos	28.25	6.50	Patrigno	42.75	11.00
7	Pathicum	31.50	7.25	Patriot	49.25	12.50
8	Pathless	34.75	8.00	Patrisso	55.75	14.00
9	Pathogenic	38.00	8.75	Patrobilus	62.25	15.50
10	Pathogony	41.25	9.50	Patroclo	68.75	17.00
12	Pathology	47.75	11.00	Patrolle	81.75	20.00

If without Nickel-Plated Trap, deduct \$5.75.

Waste Coupling for Lead Pipe is provided when Urinal is furnished without Trap.

Dimensions:

Depth of Urinal, $7\frac{1}{2}$ inches; front to back inside, $9\frac{1}{2}$ inches; front to back over all, 12 inches; back, 10 inches high.

Urinals over 5 feet in length are made in two or more pieces and are well bolted together.

Any Urinal listed can be furnished to order with outlet on left hand end, but will invariably be sent as shown, unless otherwise specified.

For approximate weights, see page 136.

In Orders and Specifications give Plate Numbers and Sizes.

APPROXIMATE WEIGHTS CRATED.

Automatic Siphon Eduction Public Urinals.

Length, ft.	4	5	6	7	8	9	10	11	12
448-C, as shown, lbs.....	350	375	400	425	500	550	600	650	700
450-C, as shown, lbs.....	560	705	900	1070	1190
450½-C, as shown, lbs.....

Weight of separate parts.

Flushing Pipe, per foot, lbs.....	2½
Traps, complete, each, lbs.....	75
Brackets, each, lbs.....	9
Single Partition, lbs.....	70

Automatic Washout Public Urinals.

Length, ft.....	5	6	7	8	10	12	14	16
451-C, as shown, lbs.....	250	300	350	400	500	600	700	800
452-C, as shown, lbs.....	630	750	920	1090	1260	1430

Weight of separate parts.

Flushing Pipe, per foot, lbs.....	2½
Trap Standard (18-inch), each, lbs.....	45
Brackets, each, lbs.....	9

Roll Rim Public Urinals.

Length, ft.....	2	2½	3	3½	4	5	6
457-C, as shown, lbs.....	54	80	90	110	130	180	215

Length, ft.....	7	8	9	10	12
457-C, as shown, lbs.....	250	290	325	360	430
Brackets, each, lbs.....	9				

Above weights are for Enameled Fixtures; weights for Painted or Galvanized Fixtures are approximately 10 per cent less.

In Orders and Specifications give Plate Numbers.

VITREOUS CHINA PEDESTAL SIPHON JET URINAL.

WITH HIGH BACK.



460-C.

Has Horizontal Back Supply and Bottom Outlet.

Code.....	Patronado
Each	\$25.00
Shipping weight, lbs.....	90
Shipping measurement, cubic feet.....	5 ⁷ / ₁₂

One in a barrel.

Dimensions :

Height at back, 29 inches; height from floor to lip, 20 inches; width at back, 13 ¹/₂ inches; distance from center of supply to floor, 26 ¹/₂ inches; from face of supply spud to center of outlet, 10 ³/₈ inches; outlet, 2 inches inside and 3 inches over the flange.

In Orders and Specifications give Plate Numbers.

VITREOUS CHINA SIPHON JET URINALS.



461-C.

BACK OUTLET.

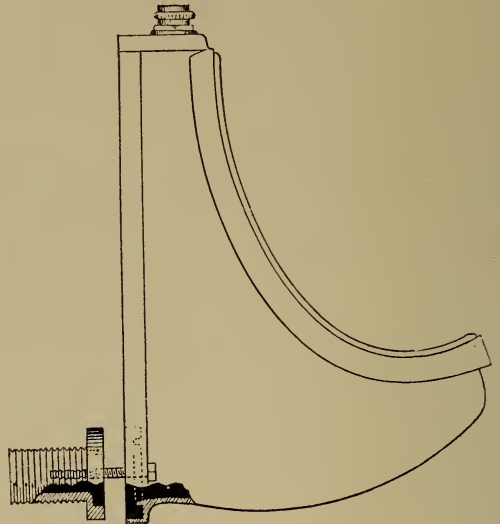

462-C.

SECTIONAL, SHOWING OUTLET CONNECTION.

Code	Patronize
Size, inches.....	18x21 1/2
Each.....	\$15.00
Weight each, pounds.....	64

Inlet connection, one-inch Iron Pipe or one-inch Slip Joint; Outlet, two-inch Iron Pipe.
Center of Inlet connection to wall, 1 7/8 inches; center of Outlet to top of Inlet connection, 18 3/4 inches.



463-C.

BOTTOM OUTLET.

Code.....	Patrullar
Size, inches.....	18x24
Each.....	\$15.00
Weight each, pounds.....	64

Inlet connection, one-inch Iron Pipe or one-inch Slip Joint; Outlet two-inch Iron Pipe or two-inch Slip Joint.

Center of Inlet connection to wall, 1 7/8 inches; center of Outlet connection to wall, 2 5/8 inches.

In Orders and Specifications give Plate Numbers.

VITREOUS CHINA URINALS.

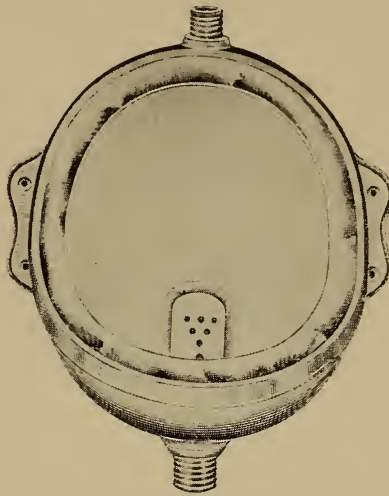

464.C.

FLAT BACK CHINA URINAL.

Code.....	Pattant	Patteggia	Pattemars
Numbers	1	2	3
Size.....	Large	Medium	Small
Inches	15x18	12x15	11½x14
Each	\$8.00	6.00	5.00
Weight each, lbs.....	15	14	11½
Shipping measurement, cubic feet.....	3	2⅓	1⅓½

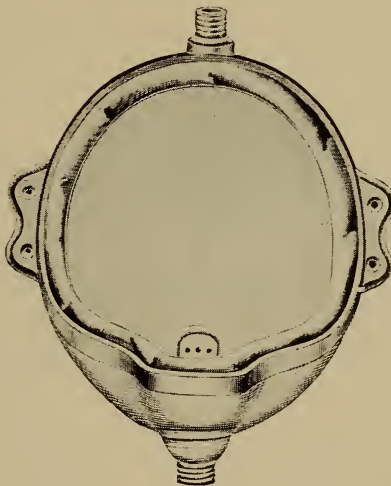

465.C.

FLAT BACK LIPPED CHINA URINAL.

Code.....	Patulcius	Patullas
Numbers	1	2
Size.....	Large	Medium
Inches.....	15x18	12x15
Each	\$10.00	8.00
Weight each, lbs.....	21	15½
Shipping measurement, cubic feet.....	4⅓	3¼

In Orders and Specifications give Plate Numbers and Sizes.

VITREOUS CHINA URINALS.

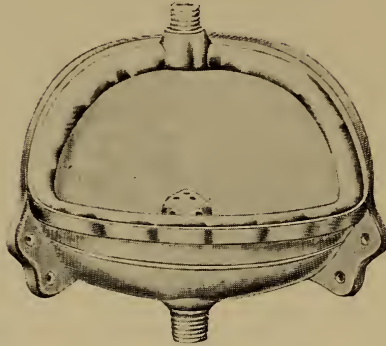

466-C.

CORNER CHINA URINAL.

Code	Paturable	Paturins	Paturnia
Numbers	1	2	3
Size.....	Large	Medium	Small
Inches	12x12	11x11	10¼ x10¼
Each.....	\$8.00	6.00	5.00
Weight each, lbs.....	19	17	14
Shipping measurement, cubic feet.....	3¾	2⅞	2

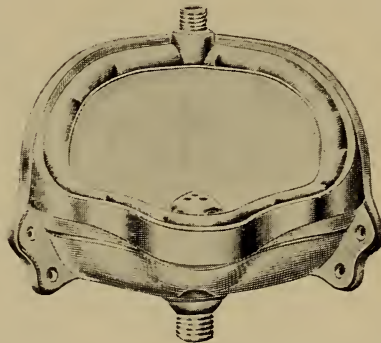

467-C.

CORNER LIPPED CHINA URINAL.

Code.....	Patusco	Patziges
Numbers	1	2
Size.....	Large	Medium
Inches.....	12x12	11x11
Each	\$10.00	8.00
Weight each, lbs.....	21	17
Shipping measurement, cubic feet.....	3⅝	2¾

In Orders and Specifications give Plate Numbers and Sizes.

PORCELAIN ENAMELED IRON URINALS.

STANDARD PATTERN.

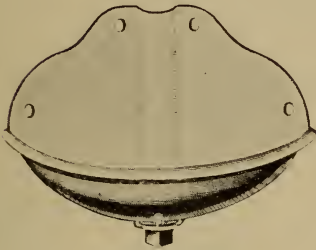

470-C.

Corner.



471-C.

Half Circle.

ENAMELED CORNER URINALS—470-C.

Code	Paukant	Paukenton	Pauldron
Numbers	1	2	3
Length of side, inches.....	7	9	12
Each.....	\$1.75	2.25	2.75
Weight each, lbs.....	8	9	13
Shipping measurement each, cubic feet

ENAMELED HALF CIRCLE URINALS—471-C.

Code	Paulician	Paulilla
Numbers.....	1	2
Length of back, inches.....	12	15
Each.....	\$2.50	3.00
Weight each, lbs.....	9	16
Shipping measurement each, cubic feet.....

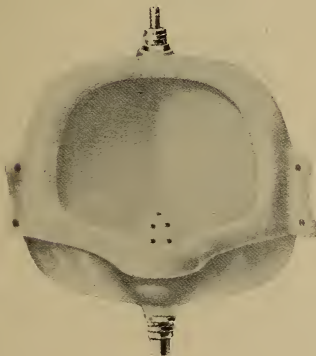

472-C.

PORCELAIN ENAMELED CORNER LIPPED URINAL.

15 inches high, 13½ inches along wall.

With Inlet and Outlet Couplings.

Code.....	Paulitz	Paulonia
Style.....	Enameled inside	Enameled all over
Each.....	\$10.00	12.00

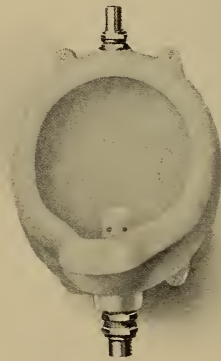

473-C.

PORCELAIN ENAMELED FLAT BACK LIPPED URINAL.

15 inches high, 13 inches wide.

With Inlet and Outlet Couplings.

Code.....	Paumett	Paumier
Style.....	Enameled inside	Enameled all over
Each.....	\$10.00	12.00

In Orders and Specifications give Plate Numbers and Sizes.

URINAL COCKS.

FOR IRON PIPE. SCREW ON TAIL.



480-C.

Compression.

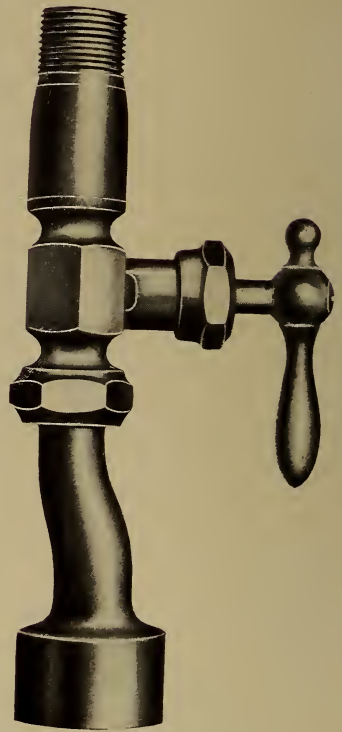

481-C.

Fuller.

Code.....	Paumoyer	Pauperabo
	Finished	Nickel-Plated
Size, inch.....	1/2	1/2
Per dozen	\$19.00	22.00
Weight per doz., lbs.....	6 1/4	6 1/4

480-C is either 5 or 6 inches over all.

Code	Pauperavi
	Nickel-Plated
Size, inch ..	1/2
Per dozen.....	\$34.00
Weight per doz., lbs.....	8

481-C has union coupling and is 8 inches over all.

One half dozen in a box.

In Orders and Specifications give Plate Numbers and Sizes.

SELF-CLOSING URINAL COCKS.

FOR IRON PIPE. SCREW ON TAIL.



† 484-C.

Doherty.

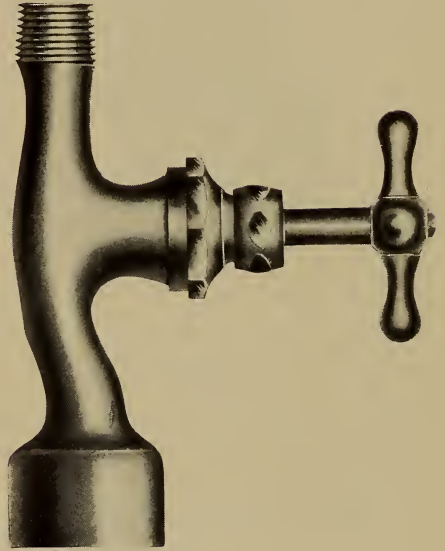

† 485-C.

Moore's.

Code.....	Pauperize	Paupertino
	Finished	Nickel-Plated
Size, inch.....	½	½
Per dozen	\$38.00	44.00
Weight per doz., lbs.....	8	8

Code.....	Paurdie	Pausabile
	Finished	Nickel-Plated
Size, inch.....	½	½
Per dozen.....	\$38.00	44.00
Weight per doz., lbs.....	8½	8½

484-C is 6 or 7½ inches over all.

485-C is 6 inches over all.

One half dozen in a box.

† Carried in San Francisco only.

In Orders and Specifications give Plate Numbers and Sizes.

URINAL TRAPS.

NICKEL-PLATED BRASS URINAL TRAPS WITH ADJUSTABLE FLANGE AND STRAIGHT COUPLING.

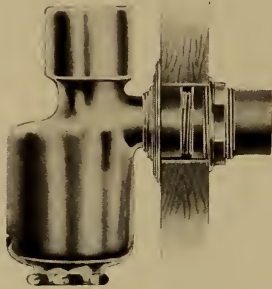

488-C.

Code.....	Pausando
Each.....	\$3.00
Weight each, lbs.....	4¼
One in a package.	

NICKEL-PLATED BRASS BAG TRAPS WITH SLIP JOINT OUTLET TUBE.

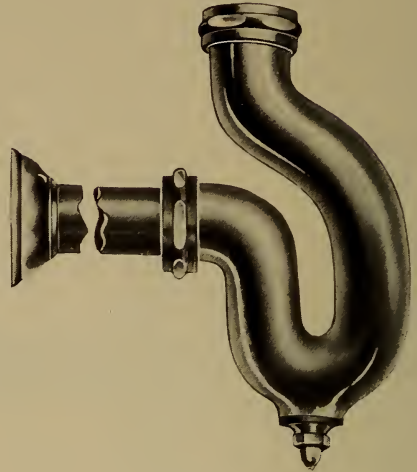

489-C.

Code.....	Pausavate
Size, inches.....	1½
Each.....	\$2.75
Weight each, lbs.....	3½
One in a box.	

URINAL OUTLET CONNECTIONS.

NICKEL-PLATED BRASS.



490-C.

For Slip Joint.

Code.....	Pauserl
Each.....	\$1.00
Length of Tube, in.....	3
Diameter of Tube, in.....	1¼
Weight each, lbs.....	½

Can be used with 489-C.

URINAL INLET CONNECTIONS.

BRASS.



491-C.

For Lead Pipe.

Code	Pausest	Pauseur
	Finished	Nickel-Plated
Each.....	\$1.00	1.35



492-C.

With Coupling for Iron Pipe.

Code.....	Pausike	Pausilli
	Finished	Nickel-Plated
Each.....	\$1.00	1.35

In Orders and Specifications give Plate Numbers.

ADJUSTABLE URINAL INLET CONNECTIONS.

NICKEL-PLATED BRASS WITH SLIP JOINT.

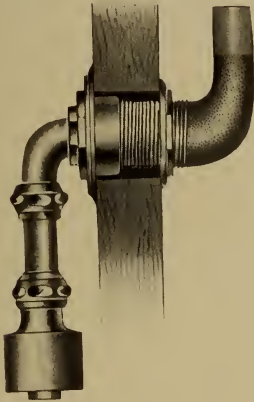

493-C.

Code Pausside
 Each \$3.40
 Weight each, lbs

ADJUSTABLE URINAL OUTLET CONNECTIONS.

NICKEL-PLATED BRASS WITH CLEANOUT AND ADJUSTABLE FLANGE.

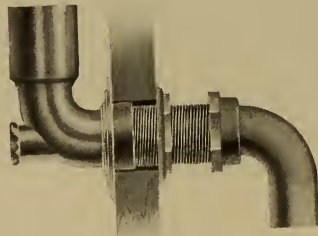

494-C.

Code Pautaren
 Each \$3.75
 Weight each, lbs

URINAL WASTE PIPES WITH FLANGE.

BRASS.

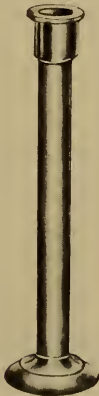

495-C.

1½-inch Tubing 20 inches long.

Code	Pauxent	Pauxillo
	Polished	Nickel-Plated
Each	\$2.50	2.75
Weight each, lbs.....	3	3

WIRE BASKETS FOR URINALS.

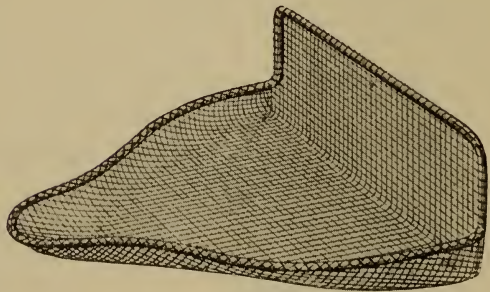

496-C.

Code Pavanion
 Each \$.....
 Weight each, lbs.....

Prices on application.

When ordering be particular to state the exact style and the number or size of Urinal Basket is intended for.

In Orders and Specifications give Plate Numbers.

ROUND CORNER AUTO-MATIC TANKS.

NATURAL OAK, ZINC LINED,
PATENT TANK BOARD.



500-C.

Cut shows style of Nos. 1 and 2.
No. 3 has no top moulding.

AUTOMATIC URINAL TANKS.

CAST IRON. PAINTED.

With Fittings and Single Couplings.

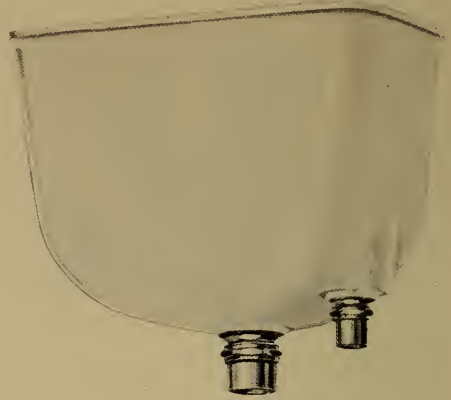

502-C.

ROUND CORNER AUTOMATIC TANKS.

Code.....	Paveam	Pavepat	Paveille
Numbers	1	2	3
Size, inches.....	16x8x11	16x7x10½	16x7x9½
Capacity, gallons.....	6	4	2
Number of Urinals Tank will flush.....	5 or 6	3 or 4	1 or 2
Size Siphon, inches.....	1½	1¼	1
Each.....	\$11.00	9.00	8.50
Weight each, lbs.....	35	30	25
Shipping measurement, cubic feet.....	2	1½	1½

AUTOMATIC URINAL TANKS.

Code	Paventato	Paveritis	Pavesada
Numbers.....	1	2	3
Capacity, gallons.....	2	5	8
Number of Urinals Tank will flush.....	2	3 to 6	7 to 10
Number of Hoppers Tank will flush.....	1	3	4 to 5
Size coupling, inches.....	1	1¼	1½
Each.....	\$8.50	10.25	11.75

Our Automatic Urinal Tanks are simple in construction, positive in action and can be regulated to flush as often as necessary.

NICKEL-PLATED BRASS CONNECTIONS FOR AUTOMATIC FLUSH TANKS.

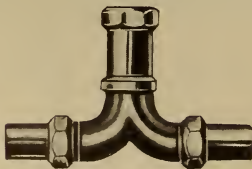

505-C.

TWO PIPE.

Code	Pavescam	Pavesotto
Size, inches	1¼ x ¾	1½ x 1¼
Each	\$5.00	5.75

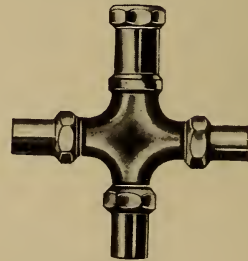

506-C.

THREE PIPE.

Code	Paveurs	Paviage
Size, inches.....	1¼ x ¾	1½ x 1¼
Each	\$5.75	7.00

In Orders and Specifications give Plate Numbers and Sizes.

URINAL STALL CUTTERS.

PORCELAIN ENAMELED INSIDE. PAINTED OUTSIDE.

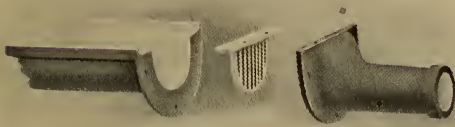

509-C.

For Single Range of Stalls.

Sections are 5 feet long and 4 inches wide; outlet piece has spigot end for 2-inch cast soil pipe.

Code Pavibundo

One section with outlet piece and grating \$12.50

Weight, lbs..... 100

Additional sections, \$10.75 each.

Price of section any length under 5 feet to make up special lengths, same price as full section.



510-C.

For Double Range of Stalls.

Sections are 5 feet long and 8 inches wide; outlet piece has spigot end for 4-inch cast soil pipe.

Code..... Pavicula

One section with outlet piece and grating \$25.00

Weight, lbs.....

Additional sections, \$21.50 each.

WASH DOWN PIPES.

FOR PUBLIC URINALS.

½-inch Iron Pipe Size with ⅛-inch holes 1 inch apart.



511-C.

Code.....	Pavidabe	Pavideti
Finish.....	Polished	Nickel-Plated
Per foot	\$1.25	1.50
Weight per foot, lbs.....	7/8	7/8

Price does not include Cap or Stop Cock.
Can furnish any size, style or length to order.

ANGLE STALL CLAMPS.

BRASS.



512-C.

	Plain.	
Code	Paviendo	Pavillon
	Finished	Nickel-Plated
Each.....	\$0.50	.60



513-C.

	Heavy.	
Code	Paviment	Paviola
	Finished	Nickel-Plated
Each.....	\$0.75	.90



514-C.

	Fancy.	
Code	Paviour	Paviso
	Finished	Nickel-Plated
Each.....	\$.....

State how many single and how many double nut bolts are required and thickness of Slab when ordering Angle Clamps with Bolts.

In Orders and Specifications give Plate Numbers.

URINAL STALL CLAMPS.

Each Furnished with One Double Nut Bolt.

BRASS.



516-C.

LEFT TOP.

Code.....	Pavitaret Finished	Pavitate Nickel-Plated
Each	\$1.25	1.50



517-C.

CENTER TOP.

Code.....	Pavoison Finished	Pavonaco Nickel-Plated
Each.....	\$1.50	1.75



518-C.

RIGHT TOP.

Code.....	Pavonador Finished	Pavoncell Nickel-Plated
Each.....	\$1.25	1.50

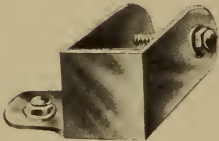

519-C.

LEFT BOTTOM.

Code.....	Pavonia Finished	Pavonize Nickel-Plated
Each.....	\$1.25	1.50

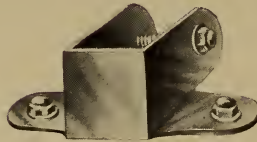

520-C.

CENTER BOTTOM.

Code.....	Pavorde Finished	Pavots Nickel-Plated
Each.....	\$1.50	1.75

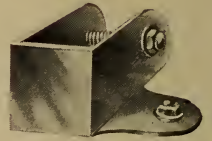

521-C.

RIGHT BOTTOM.

Code.....	Pawnor Finished	Paxilli Nickel-Plated
Each.....	\$1.25	1.50



522-C.

CENTER SUPPORT.

Code.....	Paxus Finished	Payant Nickel-Plated
Each.....	\$2.00	2.25



523-C.

*PARTITION SUPPORT FOR LEG.

Code.....	Payaso Finished	Payelle Nickel-Plated
Each.....	\$2.25	2.50



524-C.

WALL PLATE.

Code.....	Paynim Finished	Payoller Nickel-Plated
Each.....	\$.....

* Plain Leg for 523-C, 12 inches long: Finished, \$1.00; Nickel-Plated, \$1.25.

When ordering Clamps for Marble or Slate, state thickness of Slabs, Partitions, etc., and number of Single and Double Nut Bolts required.

In Orders and Specifications give Plate Numbers and Sizes.

ORNAMENTAL BRASS RAILING STANDARDS.

FOR MARBLE OR SLATE STALLS. HEIGHT, 12 INCHES.

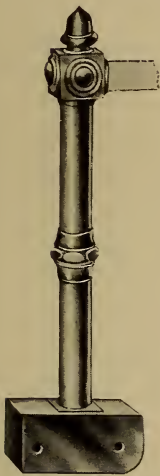

530-C.
End.

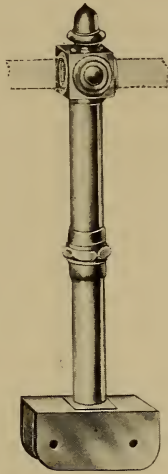

531-C.
Intermediate.

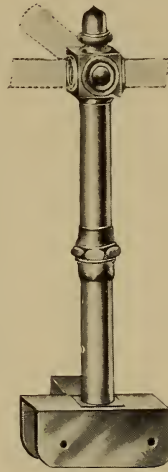

532-C.
Partition.

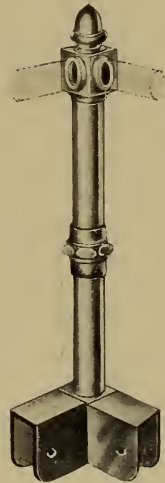

533-C.
Angle.

Code.....	Paysage Finished	Paysanne Nickel-Plated	Pazada Finished	Pazend Nickel-Plated	Pazientar Finished	Paziguar Nickel-Plated	Pazzament Finished	Pazzuccio Nickel-Plated
Each.....	\$3.50	4.00	3.50	4.00	4.00	4.50	3.50	4.00
Weight each, lbs..	2½	2½	2¾	2¾	2¾	2¾	2¾	2¾

When ordering Top Standards for Marble or Slate, state thickness of Slabs, Partitions, etc.

ORNAMENTAL BRASS LEGS.

FOR MARBLE OR SLATE STALLS. HEIGHT, 12 INCHES.



534-C.
End.



535-C.
Intermediate.

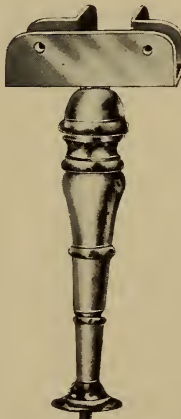

536-C.
Partition.

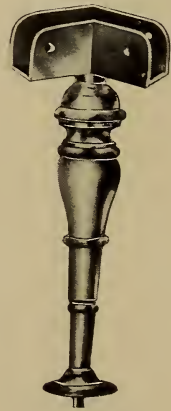

537-C.
Angle.

Code.....	Peaceless Finished	Peachy Nickel-Plated	Peacock Finished	Peahen Nickel-Plated	Peakish Finished	Pearlash Nickel-Plated	Pearmain Finished	Peasants Nickel-Plated
Each.....	\$3.50	4.00	3.50	4.00	4.00	4.50	3.50	4.00
Weight each, lbs.	2½	2½	2¾	2¾	2¾	2¾	2¾	2¾

When ordering Legs for Marble or Slate, state thickness of Slabs, Partitions, etc.

In Orders and Specifications give Plate Numbers.

PLAIN BRASS RAILING STANDARDS.

FOR MARBLE OR SLATE STALLS. HEIGHT, 12 INCHES.

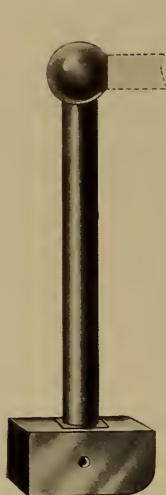

538-C.
End.

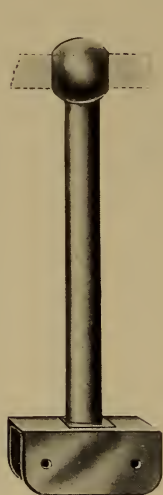

539-C.
Intermediate.

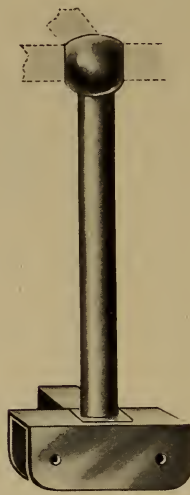

540-C.
Partition.

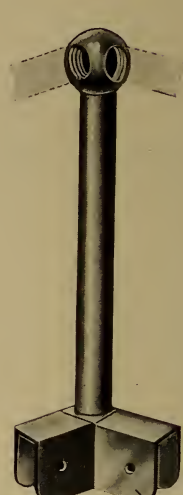

541-C.
Angle.

Code.....	Peatone Finished	Pebres Nickel-Plated	Pebriner Finished	Pecatriz Nickel-Plated	Peccable Finished	Peccante Nickel-Plated	Peccavel Finished	Pecchia Nickel-Plated
Each	\$3.00	3.50	3.00	3.50	3.50	4.00	3.00	3.50
Weight each, lbs..	1½	1½	1¾	1¾	1¾	1¾	1¾	1¾

When ordering Top Standards for Marble or Slate, state thickness of Slabs, Partitions, etc.

PLAIN BRASS LEGS.

FOR MARBLE OR SLATE STALLS. HEIGHT, 12 INCHES.

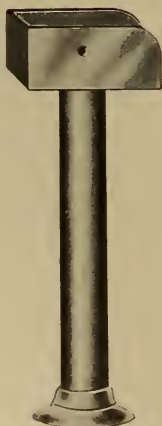

542-C.
End.

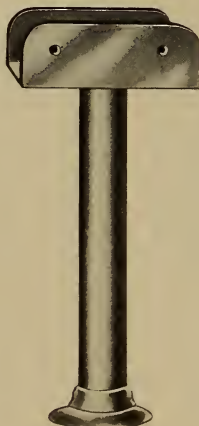

543-C.
Intermediate.

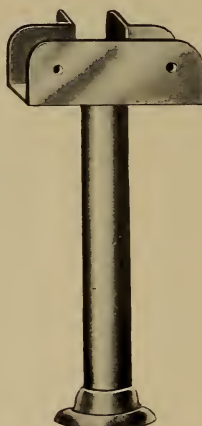

544-C.
Partition.

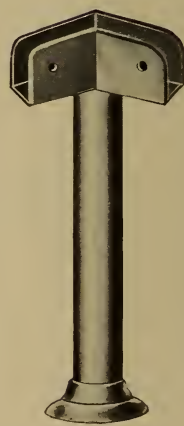

545-C.
Angle.

Code.....	Pechait Finished	Pechartig Nickel-Plated	Pechoel Finished	Pechopal Nickel-Plated	Pechtorf Finished	Pechugon Nickel-Plated	Pecinal Finished	Pecoreas Nickel-Plated
Each	\$3.00	3.50	3.00	3.50	3.50	4.00	3.00	3.50
Weight each, lbs..	1½	1½	1¾	1¾	1¾	1¾	1¾	1¾

When ordering Legs for Marble or Slate, state thickness of Slabs, Partitions, etc.

In Orders and Specifications give Plate Numbers.

BOLTS FOR MARBLE OR SLATE.

BRASS WITH NICKEL-PLATED HEADS. BOLTS $\frac{1}{4}$ INCH IN DIAMETER.



550-C.

TWO LOOSE HEADS.



551-C.

ONE LOOSE HEAD AND NUT.



552-C.

ONE LOOSE HEAD.

Code.....	Pecorella	Code.....	Pecorone	Code.....	Pectebar
Per dozen.....	\$1.00	Per dozen.....	\$1.00	Length, inches.....	1 $\frac{3}{4}$
Weight per dozen, lbs.	$\frac{3}{4}$	Weight per dozen, lbs.	$\frac{3}{4}$	Per dozen.....	\$1.00
				Weight per dozen, lbs.	$\frac{3}{4}$

In ordering Bolts for Marble or Slate, state thickness of Slab.

BOLT HEADS.

BRASS NICKEL-PLATED.



560-C.

Square.



561-C.

Octagon.

Code	Pectendos	Pectinator
Style.....	Square	Octagon
Per dozer..	\$.50	.45

SQUARE NUTS.

BRASS.

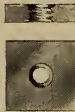

562-C.

$\frac{1}{16}$ -inch square, $\frac{1}{4}$ -inch thread.

Code.....	Pectoral
Per dozen.....	\$0.25

WASHERS.

BRASS NICKEL-PLATED.

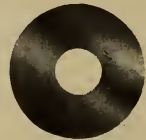

566-C.

$\frac{3}{4}$ -inch diameter, $\frac{5}{16}$ -inch hole.

Code.....	Pecuatos
Per dozen.....	\$0.25
Weight per gross, lbs...	$\frac{1}{2}$

One gross in a package.

THREADED BRASS ROD.

CONTINUOUS THREAD 12 INCHES LONG, $\frac{1}{4}$ INCH DIAMETER.

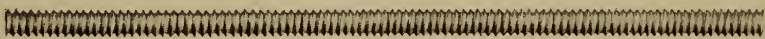

568-C.

Code	Pecudalem
Per foot.....	\$0.20
Weight per foot, lbs.....	$\frac{1}{8}$

In Orders and Specifications give Plate Numbers.

EXPANSION BOLTS.

BRASS.



569-C.

NICKEL-PLATED ROUND HEAD.

Code.....	Pecudifer	Peculator	Peculio
Size.....	¼x1¼	¼x1½	1½x2
Each.....	\$0.26	.26	.26



570-C.

NICKEL-PLATED COUNTER SUNK HEAD.

Code.....	Pecunia	Pecuniale	Pecunious
Size.....	¼x1¼	¼x1½	¼x2
Each.....	\$0.26	.26	.26

The size of the bolt is always understood to be the diameter of the brass of which it is made, not of the expansion parts.

Above bolts are for 5/16-inch hole and will expand to 3/16-inch.



571-C.

FINISHED BRASS. ROUND HEAD.

Code.....	Pedaggio
Size, inches.....	3/16x1¼
Per dozen.....	\$0.80

For 3/8-inch hole and will expand to 1/2-inch.

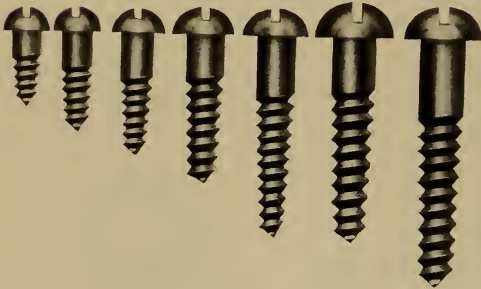

575-C.

ROUND HEAD IRON NICKEL-PLATED.

Code.....	Pedamen	Pedaneo	Pedantar	Pedantical	Pedantize
Size.....	½x6	¾x8	1x10	1¼x10	1½x12
Per gross.....	\$0.80	.95	1.20	1.30	1.65
Code.....	Pedantry	Pedation	Pedatuross	Pedell	Pederota
Size.....	2x12	2½x12	3x9	3x14	4x14
Per gross.....	\$2.00	2.60	3.10	3.50	5.90

One gross in a package.

ROUND HEAD BRASS NICKEL-PLATED.

Code.....	Pedial	Pedibus	Pedicinos	Pedicles	Pediconis	
Size.....	¾x5	½x6	¾x8	1x10	1¼x10	
Per gross.....	\$1.12	1.30	2.00	3.15	3.50	
Code.....	Pediculos	Pedicure	Pedida	Pedieux	Pedifere	Pediform
Size.....	1½x12	2x12	2½x12	3x10	3x14	4x14
Per gross.....	\$5.35	6.85	9.70	13.70	14.30	19.00

One gross in a package.

WOOD SCREWS.

FLAT HEAD IRON.

Code.....	Pedagna	Pedagogo	Pedales	Pedalite
Size.....	¾x9	1x10	1½x12	2x12
Per gross	\$1.00	1.20	1.65	2.00

One gross in a package.

In Orders and Specifications give Plate Numbers and Sizes.

BOX FLANGED SPRING HINGES FOR STALLS.

HEAVY BRASS. WITH BOLTS.

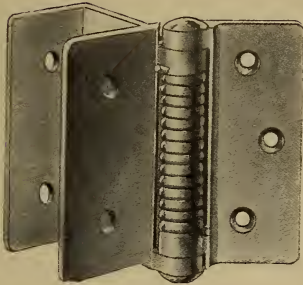

580-C.

SINGLE BOX HINGE.

Code.....	Pedimento	Pedinando
	Finished	Nickel-Plated
Length of Flange, in.....	3 3/4	3 3/4
Per pair.....	\$5.50	6.00
Weight, per pair, lbs.....	2 1/2	2 1/2

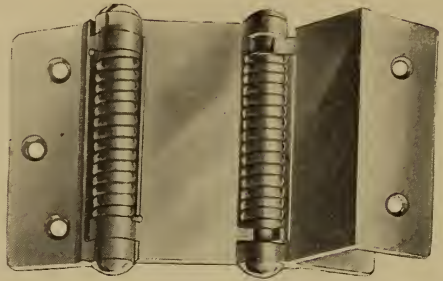

581-C.

DOUBLE BOX HINGE.

Code.....	Pedinassi	Pedinava
	Finished	Nickel-Plated
Length of Flange, in.....	3 3/4	3 3/4
Per pair.....	\$13.00	13.50
Weight, per pair, lbs.....	3	3

580-C Single Box Hinges are also made with one side of box loose so same may be adjusted to any thickness of Marble.

State thickness of door and Marble when ordering.

STALL DOOR BOLTS AND STOPS.

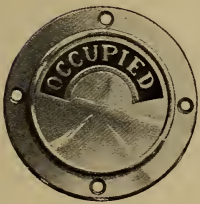

585-C.

OUTSIDE VIEW.

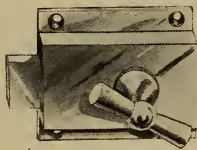

586-C.

INSIDE VIEW.



587-C.

STRIKE PLATE.

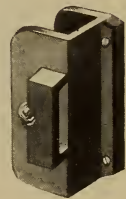

588-C.

BOX STOP.

With Bolt Slot Rubber Bumper.

INDICATOR BOLT AND STRIKE PLATE.

Extension for 1 to 2-inch doors.

Code	Pedireme	Peditorio
	Finished	Nickel-Plated
Size of case, inches	2 1/2 x 2 3/8	2 1/2 x 2 3/8
Diameter of Indicator, in...	3/4	3/4
Each.....	\$4.00	4.50
Weight each, lbs.....	1 1/4	1 1/4

One in a box.

Code	Pedleress	Pedocomio
	Finished	Nickel-Plated
Inches.....	2 1/4 x 2	2 1/4 x 2
Each.....	\$1.25	2.00
Weight each, lbs.....	1/2	1/2

State thickness of Marble when ordering.

In Orders and Specifications give Plate Numbers and Finish.

SECTION 3.

SOLID PORCELAIN BATHS,

IRON PORCELAIN ENAMELED BATHS.

STEEL, COPPER AND ZINC BATHS.

SHOWER BATHS AND

BATH ROOM FITTINGS.



HOLBROOK, MERRILL & STETSON,

INCORPORATED.

SAN FRANCISCO, LOS ANGELES AND NEW YORK.

BATHS AND BATH ROOM FITTINGS.

“Ideal” Solid Porcelain Baths, illustrated on the first seven pages of this section, are produced by the best mechanical talent and made of the finest materials. Special attention has been given to durability as well as finish. All of the fixtures shown on the above-mentioned pages are **First Quality** or **“Class A”** goods. We can, when competition makes it necessary, quote prices on **“Class B”** and **“Class C”** wares.

Iron Porcelain Enameled Baths, illustrated on the pages following Solid Porcelain Ware, are all guaranteed by the manufacturers as well as ourselves, and are of the finest quality and latest design in their different classes.

Bath Room Fittings are polished brass, heavily nickel-plated, the better grade of towel bars and shelves being of plate glass.

In ordering goods from this section by telegraph it is only necessary to use the code word over or opposite the number or size of the article wanted, preceded by words from code in front of this book.

Example: Cubicados one perigeon.

Translation: Ship via Southern Pacific Railroad one five-foot-six special enameled bath tub with three-inch rim.

“IDEAL” SOLID PORCELAIN BATHS.

FRENCH PATTERN — ON BASE.

TO TILE IN AT BACK.

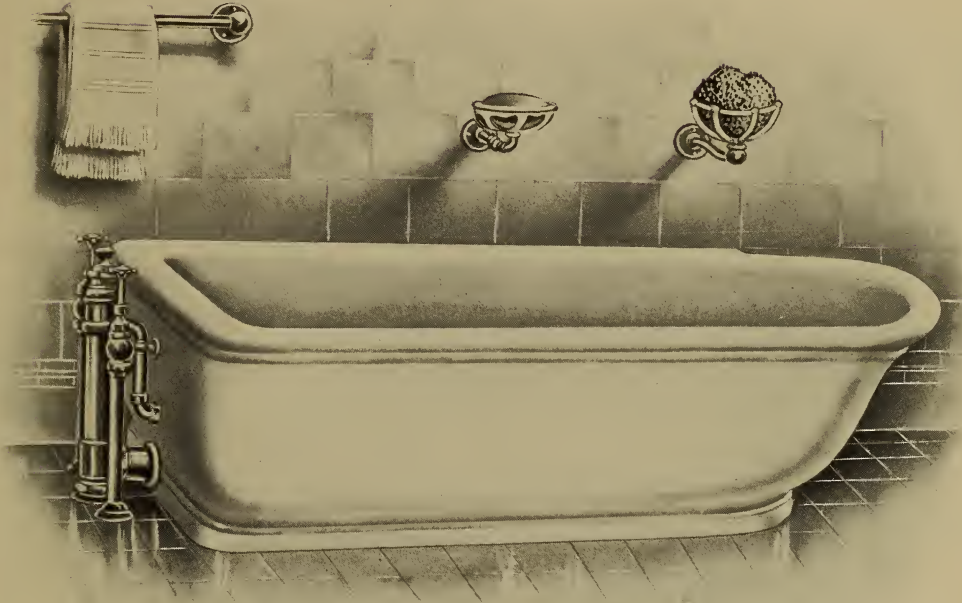

600-C.

French Pattern Roll Rim Solid Porcelain Bath, Glazed Pure White inside and over Roll Rim, outside unfinished; Nickel-Plated Bell Supply and Waste with China Name Plates for Hot and Cold Water and Waste.

Code for Right Hand as shown.....	Pepiones	Pepite
Code for Left Hand.....	Pepitoria	Pepitoso
Size, feet.....	5	5½
Length outside Tub only, inches.....	60	66
Each, complete as described	\$186.00	196.00
Shipping weight, pounds.....	775	800
Shipping measurement, cubic feet.....	39½	42¾

For Exterior Finish and Decorations, see page 186.

Dimensions: Width outside, 30 inches; depth inside, 19 inches; height from floor to top of rim, 21 inches.

Nickel-Plated Sponge Holder No. 180, \$1.60. Nickel-Plated Towel Bar No. 16, 30 inches long, \$3.50. Nickel-Plated Soap Dish with removable Porcelain Tray No. 259, \$2.00.

In Orders and Specifications give Plate Numbers and Sizes.

“IDEAL” SOLID PORCELAIN BATHS.

“NEW MONARCH” — ON BASE.

TO TILE IN CORNER.



602-C.

“New Monarch” Roll Rim Solid Porcelain Bath, Glazed Pure White inside and over Roll Rim outside unfinished; Nickel-Plated Bell Supply and Waste with China Name Plates for Hot and Cold Water and Waste.

Code for Right Hand as shown.	Peplides	Peplium	Pepolim
Code for Left Hand.....	Peponite	Pepperco	Peppernel
Size, feet.....	5	5½	6
Length outside, Tub only inches.....	60	66	72
Each, complete as described.....	\$186.00	196.00	216.00
Shipping weight, pounds.....	775	800	830
Shipping measurement, cubic feet.....	39½	42¾	46¼

For Exterior Finish and Decorations, see page 186.

Dimensions: Width outside, 30 inches; depth inside, 19 inches; height from floor to top of rim, 21 inches.

Vitreous China Soap Holder, \$1.90. Vitreous China Sponge Holder, \$2.50. Nickel-Plated Towel Bar No. 16, 30 inches long, \$3.50. Nickel-Plated Hand Rail, 18 inches long, \$4.00.

In Orders and Specifications give Plate Numbers and Sizes.

“IDEAL” SOLID PORCELAIN BATHS.

FRENCH PATTERN—ON FEET.

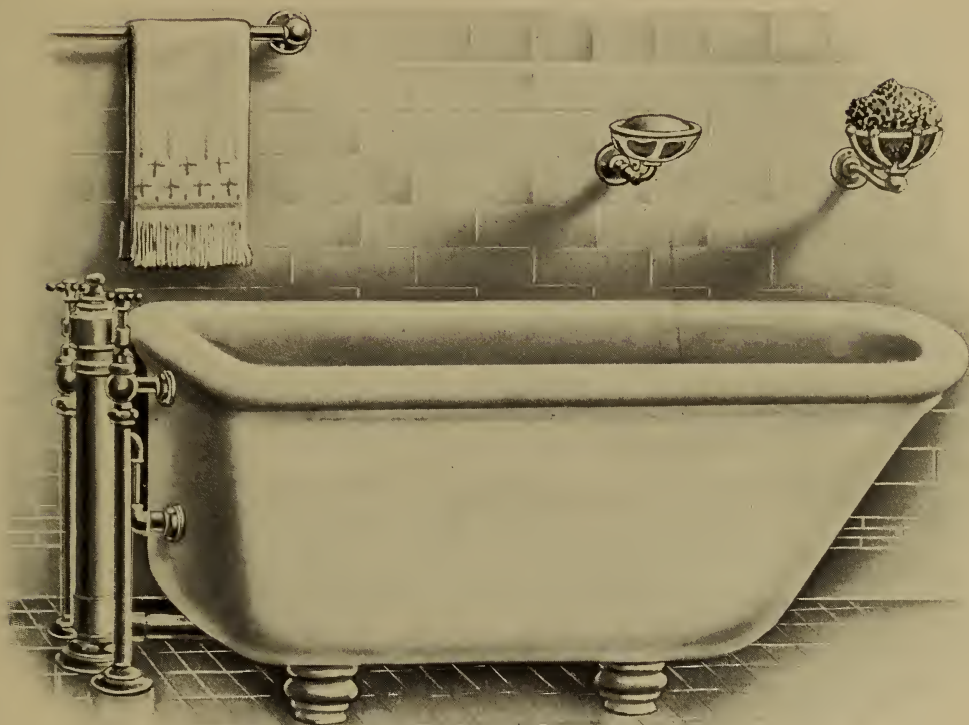

604-C.

French Pattern Roll Rim Solid Porcelain Bath, Glazed Pure White inside and over Roll Rim, outside unfinished; four Glazed Legs; Nickel-Plated Bell Supply and Waste with China Name Plates for Hot and Cold Water and Waste.

Code.....	Peptico	Peptique	Peptogene	Pepulero	Pepulit	Pequice
Size, feet.....	4½	5	5½	6	6½	7
Length outside, Tub only, inches.....	54	60	66	72	78	84
Each, complete as described.....	\$140.00	150.00	160.00	180.00	200.00	225.00
Shipping weight, pounds.....	660	735	760	795	1150	1200
Shipping measurement, cubic feet.....	37½	41	44½	48	57½	67

For Exterior Finish and Decorations, see page 186.

Dimensions: Width outside, 30 inches; depth inside, 18 inches; height from floor to top of rim, 25½ inches; legs 4½ inches.

Note—Baths 6 feet 6 inches and 7 feet long measure 33 inches wide outside.

Nickel-Plated Sponge holder No. 180, \$1.60. Nickel-Plated Towel Bar No. 16, 30 inches long, \$3.50. Nickel-Plated Soap Dish with removable Porcelain Tray No. 259, \$2.00.

In Orders and Specifications give Plate Numbers and Sizes.

“IDEAL” SOLID PORCELAIN BATHS.

FRENCH PATTERN — ON BASE.



606-C.

French Pattern Roll Rim Solid Porcelain Bath, Glazed Pure White inside and over Roll Rim, outside unfinished; Nickel-Plated Bell Supply and Waste with China Name Plates for Hot and Cold Water and Waste.

Code.....	Peractio	Peracute	Peragites	Peragito
Size, feet.....	4½	5	5½	6
Length outside, Tub only, inches.....	54	60	66	72
Each, complete as described.....	\$151.00	161.00	176.00	196.00
Shipping weight, pounds.....	670	775	800	830
Shipping measurement, cubic feet.....	36	39½	42¾	46¼

For Exterior Finish and Decorations, see page 186.

Dimensions: Width outside, 30 inches; depth inside, 18 inches; height from floor to top of Rim, 21 inches.

Nickel-Plated Combination Sponge and Soap Holder, \$..... Nickel-Plated Towel Bar No. 16, 30 inches long, \$3.50.

In Orders and Specifications give Plate Numbers and Sizes.

“IDEAL” SOLID PORCELAIN BATHS.

ROMAN PATTERN — ON BASE.



608-C.

Roman Pattern Roll Rim Solid Porcelain Bath, Glazed Pure White Inside and over Roll Rim, outside Unfinished; Nickel-Plated Bell Supply and Waste with China Name Plates for Hot and Cold Water and Waste.

Code	Peragrada	Peralbos	Peralejo	Peraltar
Size, feet.....	4½	5	5½	6
Length outside, tub only, inches.....	54	60	66	72
Each, complete as described	\$151.00	161.00	176.00	196.00
Shipping weight, pounds.....	670	775	800	815
Shipping measurement, cubic feet	37½	41¼	45	48¾

For Exterior Finish and Decorations, see pages 194 and 195.

Dimensions :

Width outside, tub only, 30 inches; depth inside, 18 inches; height from floor to top of rim, 21 inches.

Nickel-Plated Sponge Holder, No. 11, \$1.60. Nickel-Plated Soap Dish, No. 62, \$1.50. Nickel-Plated Towel Bar, No. 16, 30 inches long, \$3.50.

In Orders and Specifications give Plate Numbers and Sizes.

“IDEAL” SOLID PORCELAIN SITZ-BATHS.

WITH NICKEL-PLATED BELL SUPPLY AND WASTE WITH CHINA NAME PLATES.

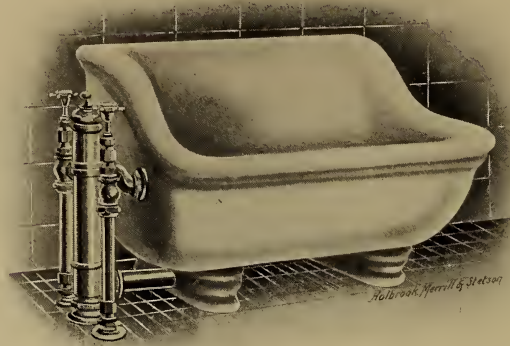

610-C.

On Legs.

Code	Peramans	Peramaros
Description.....	Glazed Inside and Over Roll Rim	Glazed Inside and Outside
Each, complete as described.....	\$70.00	90.00
Shipping weight, pounds.....	230	230
Shipping measurement, cubic feet	18 1/3	18 1/3

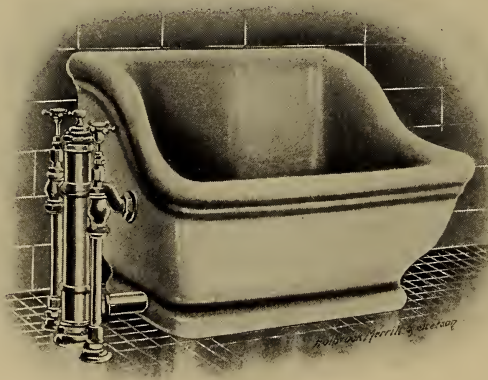

612-C.

On Base.

Code	Peramica	Perampli
Description.....	Glazed Inside and Over Roll Rim	Glazed Inside and Outside
Each, complete, as described.....	\$76.00	96.00
Shipping weight, pounds.....	280	280
Shipping measurement, cubic feet	20 2/3	20 2/3

For Exterior Finish and Decorations, see pages 194 and 195.

Dimensions :

Applying to 610-C and 612-C — Length, 30 inches; width, 27 inches over all; height at back, 20 3/4 inches; height at front, 15 inches.

In Orders and Specifications give Plate Numbers and Sizes.

“IDEAL” SOLID PORCELAIN FOOT BATHS.

WITH NICKEL-PLATED BELL SUPPLY AND WASTE WITH CHINA NAME PLATES.

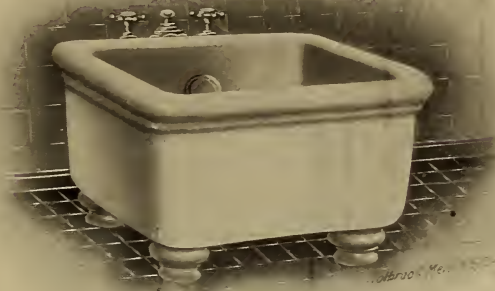

613-C.

On Legs. Glazed Pure White Inside and Outside.
Waste at bottom in center.

Code.....	Peranceps
Each, complete as described.....	\$55.00
Shipping weight, lbs.....	200
Shipping measurement, cubic feet.....	8



614-C.

On Base. Glazed Pure White Inside and Outside.
Waste through back.

Code.....	Peranton
Each, complete as described.....	\$56.00
Shipping weight, lbs.....	230
Shipping measurement, cubic feet.....	11¼

For Exterior Finish and Decorations, see pages 194 and 195.

Dimensions :

Applying to 612-C and 614-C, length outside, 26 inches; width outside, 21½ inches; height outside, 13 inches.

In Orders and Specifications give Plate Numbers and Sizes.

H. M. & S. PORCELAIN ENAMELED BATHS.

THIS BATH IS DESIGNED FOR SETTING IN MARBLE OR TILE WAINSCOTED RECESS.

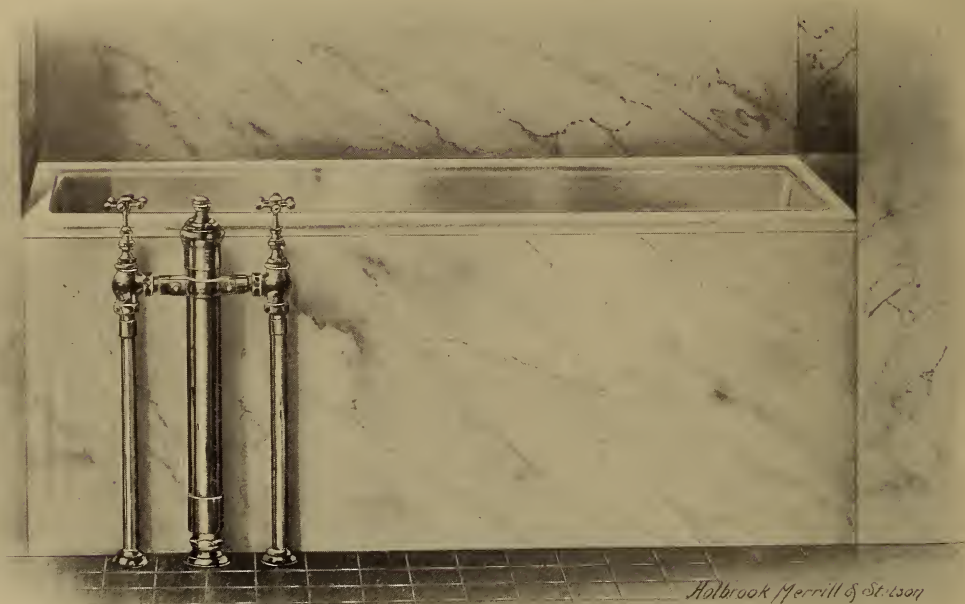

616-C.

Porcelain Enameled Bath with Nickel-Plated Bell Supply and Waste Fittings ; 3/4-inch Iron Pipe Size Supply Pipes.

Code.....	Perasper	Perasperos	Perasperum
Size, feet.....	4	4 1/2	5
Length over rim between walls, inches.....	48	54	60
Each, complete as described.....	\$75.00	80.50	87.00
Shipping weight each, pounds.....	325	370	400
Shipping measurement, cubic feet.....	22 1/4	24 3/4	27 1/6

Dimensions :

Width from wall over front rim, 28 1/2 inches ; width of roll rim, 3 1/2 inches ; flat rim, 2 1/4 inches over all, (1 inch outside tile or marble); depth inside, 17 1/2 inches.

In Orders and Specifications give Plate Numbers and Sizes.

H. M. & S. PORCELAIN ENAMELED BATHS.

This Bath is designed for setting into tile wainscoting, and can be furnished for right or left hand corner. Fittings can be furnished on exposed end of tub, if desired, instead as shown.

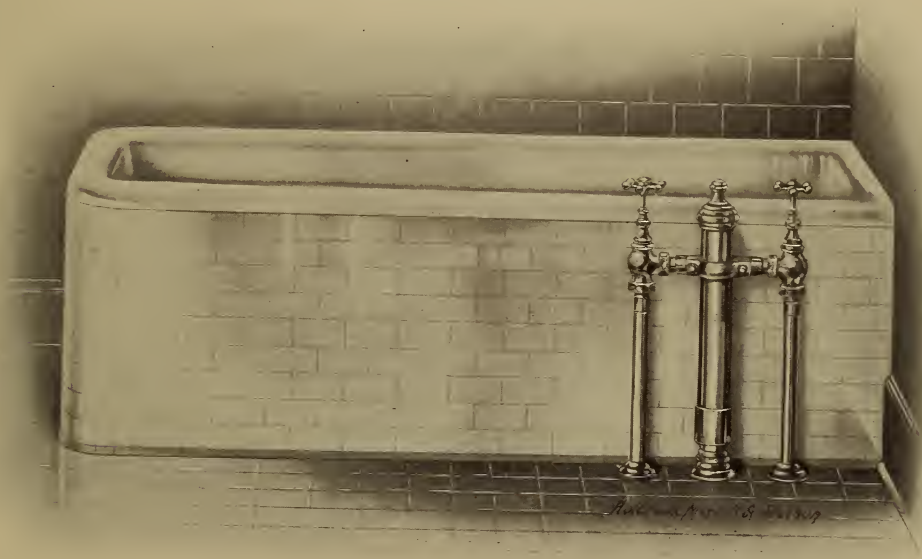

618-C.

Cut Shows Right Hand Corner Pattern.

Porcelain Enameled Bath with Nickel-Plated Bell Supply and Waste Fittings; 3/4-inch Iron Pipe Size Supply Pipes.

	Peratus	Perazim	Perbacchor
Code Right Hand.....	Perbasiabo	Perbasio	Perbeat
Code Left Hand.....	4	4½	5
Size, feet.....	50½	56½	62½
Length over rim from wall line, inches.....	\$76.50	83.50	90.00
Each complete as described.....	325	370	400
Shipping weight each, lbs.....	22¼	24¾	27½
Shipping measurement, cubic feet.....			

Dimensions :

Width from wall over front rim, 28½ inches; width of roll rim, 3½ inches; flat rim, 2¼ inches over all (1 inch outside tile); depth inside, 17½ inches.

In Orders and Specifications give Plate Numbers and Sizes.

H. M. & S. PORCELAIN ENAMELED BATHS.

RECEPTORS, SITZ AND FOOT BATHS WITH BASE INSTEAD OF FEET, TO CORRESPOND WITH THIS BATH, CAN BE FURNISHED.



620-C.

With 4¾-inch Enameled Roll Rim and Flanged Base; Nickel-Plated Bell Supply Fittings with Imperial Waste; ¾ inch Iron Pipe Size Supply Pipes with Unions at Floor.

Code.....	Perbeatum	Perbibunt	Perbitam
Size, feet.....	4½	5	5½
Length over rim, inches.....	63	69	75
Length inside, inches.....	53	59	65
Each, complete as described.....	\$93.00	97.50	103.00
Shipping weight each, lbs.....	600	650	700
Shipping measurement, cubic feet.....	39⅓	42⅝	46⅓

One in a crate.

For Exterior Finish and Decorations, see pages 194 and 195.

Dimensions:

Width inside, 25 inches; width over rim, 34½ inches; depth inside, 18½ inches; height from bottom of flange to top of rim, 23½ inches; depth of flange or base only, 5 inches; roll rim, 4¾ inches.

In Orders and Specifications give Plate Numbers and Sizes.

H. M. & S. PORCELAIN ENAMELED BATHS.



622-C.

With 4¾-inch Enameled Roll Rim; Nickel-Plated Bell Supply Fittings and Imperial Waste; ¾-inch Iron Pipe Size Supply Pipes, with Unions at floor; Exterior Finished in No. 1 Zinc White.

Code.....	Perblandi	Perboni
Size, feet	5	5½
Length over rim, inches.....	69	75
Length inside, inches.....	59	65
Each, complete as described.....	\$94.50	100.00
Shipping weight, pounds	375	400
Shipping measurement, cubic feet.....	34¾	37½

One in a crate.

If without Exterior Finish, deduct \$16.00.

For Exterior Finish and Decorations, see pages 194 and 195.

Dimensions :

Width inside, 25 inches; width over rim, 34½ inches; depth inside, 18 inches; height from floor to top of rim, 23½ inches; roll rim, 4¾ inches.

In Orders and Specifications give Plate Numbers and Sizes.

H. M. & S. PORCELAIN ENAMELED BATHS.



624-C.

With 3-inch Enameled Roll Rim; Nickel-Plated Bell Supply Fittings with Imperial Waste; 3/4-inch Iron Pipe Size Supply Pipes, with Unions at Floor; Exterior Finished in No. 1 Zinc White and Three Gold Lines.

Code	Perbreve	Perdable
Size, feet.....	5	5 1/2
Length over rim, inches	67	72
Length inside, inches.....	60 3/4	65 3/4
Each, complete as described.....	\$87.00	96.00
Shipping weight, lbs.....	350	375
Shipping measurement, cubic feet	33	35 1/2

One in a crate.

If without Exterior Finish and Gold Lines, deduct \$19.00.

For Exterior Finish and Decorations, see pages 194 and 195.

Dimensions :

Width inside, 25 1/2 inches; width over rim, 30 1/2 inches; depth inside, 18 1/4 inches; height from floor to top of rim, 23 3/4 inches; roll rim, 3 inches.

In Orders and Specifications give Plate Numbers and Sizes.

H. M. & S. PORCELAIN ENAMELED BATHS.



626-C.

With 3-inch Enameled Roll Rim; Nickel-Plated Bell Supply Fittings with Imperial Waste; $\frac{3}{4}$ Iron Pipe Size Supply Pipes, with Unions at Floor; Finished in No. 1 Zinc White with Gold Bands.

Code.....	Perdepes	Perdeur	Perdezza
Size, feet.....	5	5½	6
Length over rim, inches.....	61	67	73
Length inside, inches.....	54¾	60¾	66¾
Each, complete as described.....	\$88.50	93.50	99.00
Shipping weight, lbs.....	420	450	500
Shipping measurement, cubic feet.....	28	30½	33

One in a crate.

If without Gold Bands, deduct \$3.00. If without Exterior Finish, deduct \$16.00.
For Exterior Finish and Decorations, see pages 194 and 195.

Dimensions :

Width inside, 26 inches; width over rim, 32 inches; depth inside, 17 inches; height from floor to top of rim, 22½ inches; roll rim, 3 inches.

In Orders and Specifications give Plate Numbers and Sizes.

H. M. & S. PORCELAIN ENAMELED BATHS.



† 628-C.

With 4¾-inch Enameled Roll Rim; Nickel-Plated Bell Supply Fittings with Imperial Waste; ¾-inch Iron Pipe Size Supply Pipes.

Code.....	Perdifoil	Perdigana	Perdigar
Size, feet.....	5	5½	6
Length over rim, inches.....	61	67	73
Length inside, inches.....	51½	57½	63½
Each, complete as described.....	\$68.00	74.00	80.00
Shipping weight, pounds.....	440	500	575
Shipping measurement, cubic feet.....	33½	36⅓	39⅓

One in a crate.

If with Exterior finished No. 1 Zinc White and Three Gold Lines, add \$19.00.

For Exterior Finish and Decorations, see pages 194 and 195.

Dimensions :

Width inside, 25½ inches; width over rim, 35 inches; depth inside, 18½ inches; height from floor to top of rim, 24 inches; roll rim, 4¾ inches.

† Carried in San Francisco only.

In Orders and Specifications give Plate Numbers and Sizes.

H. M. & S. PORCELAIN ENAMELED BATHS.



† 630-C.

With 3-inch Enameled Under-Roll Rim; Cut for Double Bath Cock; 3 3/8-inch center to center of supplies, Common Overflow and Waste Plug.

Code.....	Perdigonos	Perdigoto	Perdisert	Perdivido
Size, feet.....	4 1/2	5	5 1/2	6
Length over rim, inches.....	54	60	66	72
Length, inside, inches.....	48	54	60	66
Each, as described.....	\$47.00	52.00	58.00	64.50
Shipping weight crated, lbs.....	350	400	425	475
Shipping measurement, cubic feet.....	27 1/2	30 1/4	33	35 1/2

For Brass Overflow Horn with Nickel-Plated Strainer and Nickel-Plated Plug with Rubber Stopper, add \$1.00.

For Exterior Finish and Decorations, see pages 194 and 195.
For Supply and Waste Fittings, see pages 200 to 207.

Dimensions :

Width inside, 25 inches; width over rim, 31 inches; depth inside, 19 inches; height from floor to top of rim, 24 1/2 inches; center of waste to outside of rim, 7 1/2 inches.

† Carried in San Francisco only.

In Orders and Specifications give Plate Numbers and Sizes.

H. M. & S. PORCELAIN ENAMELED BATHS.



632-C.

With 3-inch Enameled Roll Rim, with 5-inch Extension at Fitting End; Nickel-Plated Top Supply Fittings and Imperial Bath Waste, with Shampoo Sprinkler and Rubber Tube; 3/4-inch Iron Pipe Size Supply Pipes; Exterior Finished in No. 1 Zinc White.

Code.....	Perdolesco	Perdomare	Perdono	Perdrix
Size, feet.....	4	4½	5	5½
Length over rim, inches.....	56	62	68	74
Length inside, inches.....	48	53¾	60	66
Each complete as described.....	\$76.50	77.00	83.00	89.50
Shipping weight, lbs.....	300	325	350	375
Shipping measurement, cubic feet.....	24½	27	29⅓	31⅔

One in a crate.

If without Exterior Finish, deduct \$16.00.

For Exterior Finish and Decorations, see pages 194 and 195.

Dimensions :

Width inside, 24 inches; width over rim, 30 inches; depth inside, 17 inches; height from floor to top of rim, 22 inches; roll rim, 3 inches, and 5-inch extension at fitting end.

In Orders and Specifications give Plate Numbers and Sizes.

H. M. & S. PORCELAIN ENAMELED BATHS.



634-C.

With 3-inch Enameled Full Roll Rim with Wide Flat Bottom and Flanged Base, Nickel-Plated Bell Supply Fittings and Imperial Waste ; $\frac{3}{4}$ -inch Iron Pipe Size Supply Pipes.

Code.....	Perdurato	Perendure
Size, feet.....	5	5 1/2
Length over rim, inches.....	62 1/2	68
Length inside, inches.....	56 1/2	62
Each, complete as described.....	\$69.00	76.00
Shipping weight crated, lbs.....	375	400
Shipping measurement, cubic feet.....	28 3/4	31 1/4

One in a crate.

For Exterior Finish and Decorations, see pages 194 and 195.

Dimensions :

Width inside, 24 inches; width over rim, 30 inches; depth inside, 17 1/2 inches; height from bottom of flange to top of rim, 20 1/2 inches; depth of flange or base only, 4 1/2 inches; width of roll rim, 3 inches.

In Orders and Specifications give Plate Numbers and Sizes.

H. M. & S. PORCELAIN ENAMELED BATHS.

DESIGNED FOR THE PURPOSE OF REPLACING COPPER TUBS OCCUPYING LIMITED SPACE.



636-C.

With 1¼-inch Enameled Roll Rim; Drilled for Waste, 2½-inch Overflow and 1¼-inch Cock Holes, 3⅜-inch center to center.

Code.....	Perengano	Perennita	Perensap	Perfacete	Perfacile
Size, feet.....	4	4½	5	5½	6
Length over rim, inches.....	48	54	60	66	72
Length inside, inches.....	45	51	57	63	69
Each	\$27.00	27.50	30.50	35.00	40.00
Shipping weight, lbs.....	250	275	300	325	350
Shipping measurement, cubic feet.....	18¼	21	23	25	27

One in a crate.

For Brass Overflow Horn with Nickel-Plated Strainer and Nickel-Plated Waste Plug with Rubber Stopper, add \$1.00.

For Supply and Waste Fittings, see page 200 to 207.

For Exterior Finish and Decorations, see pages 194 and 195.

Dimensions :

Width inside, 21 inches; width over rim, 24½ inches; depth inside, 17 inches; height from floor to top of rim, 23 inches; roll rim, 1¼ inches.

In Orders and Specifications give Plate Numbers and Sizes.

H. M. & S. PORCELAIN ENAMELED BATHS.

DESIGNED FOR THE PURPOSE OF REPLACING COPPER TUBS OCCUPYING LIMITED SPACE.



637-C.

With 1¼-inch Enameled Roll Rim; No. 4½ Nickel-Plated Fuller Double Bath Cock, with ½-inch Iron Pipe Size Straight Supply Pipes; Nickel-Plated Connected Waste and Overflow, with Rubber Stopper and Nickel-Plated Chain.

Code.....	Perfacilis	Perfacundo	Perfecteur	Perfectrix	Perferendo
Size, feet	4	4½	5	5½	6
Length over rim, inches	48	54	60	66	72
Each, complete as described.....	\$35.00	35.50	38.50	43.00	48.00
Shipping weight, lbs.....	250	280	310	335	360
Shipping measurement, cubic feet.....	18¾	21	23	25	27

If without Nickel-Plated Supply Pipes, deduct \$2.50.

If without No. 4½ Nickel-Plated Fuller Cock, deduct \$3.00.

If without Nickel-Plated Connected Waste and Overflow, deduct \$2.50.

For Supply and Waste Fittings, see pages 200 to 207.

For Exterior Finish and Decorations, see pages 194 and 195.

Dimensions :

Width inside, 21 inches; width over rim, 24½ inches; depth inside, 17 inches; height from floor to top of rim, 23 inches; roll rim, 1¾ inches.

In Orders and Specifications give Plate Numbers and Sizes.

H. M. & S. "PREMIER" PORCELAIN ENAMELED BATHS.

SEMI-FLAT BOTTOM.



† 638-C.

With 3-inch Enameled Roll Rim and Semi-Flat Bottom; drilled for Double Bath Cock, 3 $\frac{3}{8}$ inches center to center of Supplies, Overflow and Waste Plug.

Code.....	Perferorum	Perferunt	Perfervit	Perfettivo
Size, feet	4 $\frac{1}{2}$	5	5 $\frac{1}{2}$	6
Length over rim, inches.....	54	60	66	72
Length inside, inches.....	48	54	60	66
Each, as described.....	\$29.25	32.50	36.50	42.00
Shipping weight, pounds.....	330	375	400	450
Shipping measurement, cubic feet.....	27 $\frac{3}{4}$	30 $\frac{1}{2}$	33 $\frac{1}{4}$	36

For Brass Overflow Horn with Nickel-Plated Strainer and Nickel-Plated Waste Plug with Rubber Stopper, add \$1.00.

For Supply and Waste Fittings, see pages 200 to 207.

For Exterior Finish and Decorations, see pages 194 and 195.

Dimensions :

Width inside, 24 inches ; width over rim, 30 inches ; depth inside, 17 inches ; height from floor to top of rim, 22 inches; roll rim, 3 inches; center of waste to outside of rim at waste end, 7 $\frac{1}{2}$ inches.

† Carried in San Francisco only.

In Orders and Specifications give Plate Numbers and Sizes.

H. M. & S. "PREMIER" PORCELAIN ENAMELED BATHS.

SEM.-FLAT BOTTOM.

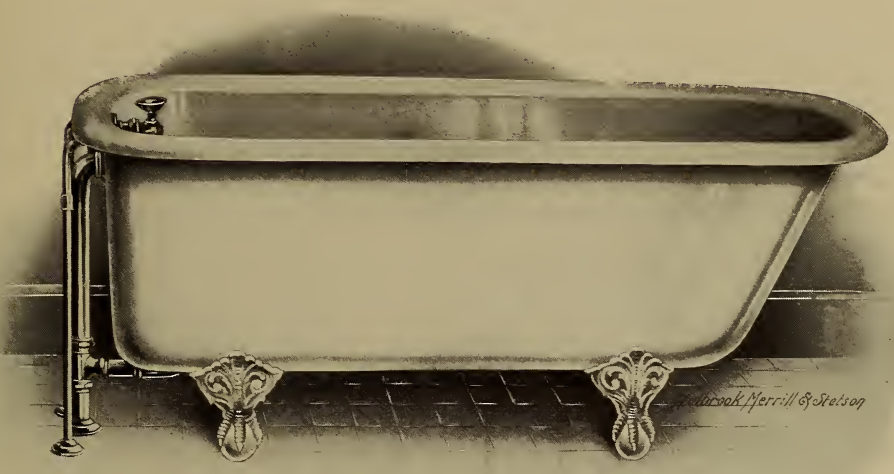

†639-C.

With 3-inch Enameled Roll Rim and Semi-Flat Bottom; No. 4½ Nickel-Plated Fuller Double Bath Cock with Straight Supply Pipes and Nickel-Plated Connected Waste and Overflow with Rubber Stopper.

Code.....	Perfetto	Perfidens	Perfidie	Perfilado
Size, feet.....	4½	5	5½	6
Length over rim, inches.....	54	60	66	72
Length inside, inches.....	48	54	60	66
Each, complete as described.....	\$37.25	40.50	44.50	50.00
Shipping weight, lbs.....	330	375	400	450
Shipping measurement, cubic feet.....	27¾	30½	33¼	36

If without Nickel-Plated Supply Pipes, deduct \$2.50.

If without No. 4½ Nickel-Plated Fuller Cock, deduct \$3.00.

If without Nickel-Plated Connected Waste and Overflow, deduct \$2.50.

For Supply and Waste Fittings see pages 200 to 207.

For Exterior Finish and Decorations, see pages 194 and 195.

Dimensions :

Width inside, 24 inches; width over rim, 30 inches; depth inside, 17 inches; height from floor to top of rim, 22 inches; roll rim, 3 inches; center of waste to outside of rim at waste end, 7½ inches.

† Carried in San Francisco only.

In Orders and Specifications give Plate Numbers and Sizes.

H. M. & S. PORCELAIN ENAMELED BATHS.

FLAT BOTTOM.



640-C.

With 3-inch Enameled Roll Rim and Wide Flat Bottom; Drilled for Double Bath Cock, 3 $\frac{3}{8}$ inches center to center of Supplies, Overflow and Waste Plug.

Code.....	Perfingis	Perfixum	Perflable	Perflamen	Perflate
Size, feet	4	4½	5	5½	6
Length over rim, inches	48	54	60	66	72
Length inside, inches	42	48	54	60	66
Each.....	\$28.75	29.25	32.50	36.50	42.00
Weight each, crated, pounds.....	300	325	350	375	400
Shipping measurement, cubic feet.....	26	28 $\frac{3}{4}$	31 $\frac{1}{2}$	34 $\frac{1}{4}$	37

One in a crate.

For Brass Overflow Horn with Nickel-Plated Strainer and Nickel-Plated Waste Plug with Rubber Stopper, add \$1.00.

For Supply and Waste Fittings see pages 200 to 207.

For Exterior Finish and Decorations see pages 194 and 195.

Dimensions :

Width inside, 24 inches; width over rim, 30 inches; depth inside, 17 inches; height from floor to top of rim, 22½ inches; roll rim, 3 inches.

In Orders and Specifications give Plate Numbers and Sizes.

H. M. & S. PORCELAIN ENAMELED BATHS.

FLAT BOTTOM.

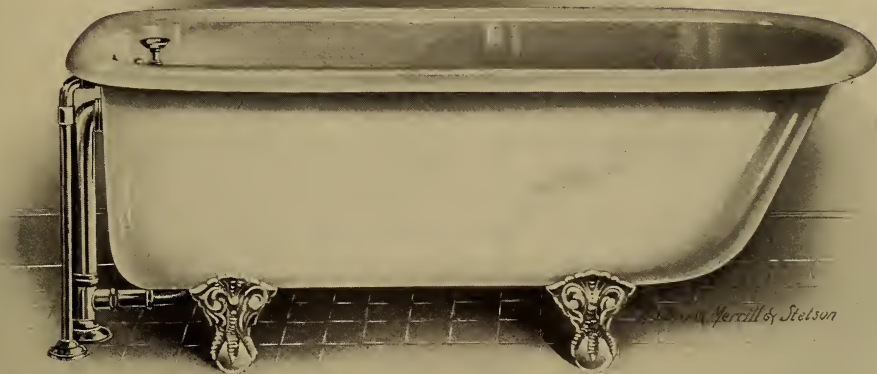

642-C.

With 3-inch Enameled Roll Rim and Wide Flat Bottom; No. 4½ Nickel-Plated Fuller Double Bath Cock with ½-inch Iron Pipe Size Offset Supply Pipes and Nickel-Plated Connected Waste and Overflow with Rubber Stopper.

Code.....	Perfluxo	Perforage	Perforer	Perfossio	Perfractus
Size, feet.....	4	4½	5	5½	6
Length over rim, inches.....	48	54	60	66	72
Length inside, inches.....	42	48	54	60	62
Each, complete as described.....	\$37.00	37.50	40.75	44.75	50.25
Shipping weight each, pounds.....	300	315	345	370	400
Shipping measurement, cubic feet.....	26	28¾	31½	34¼	37

One in a crate.

If without Nickel-Plated Supply Pipes, deduct \$2.75.

If without No. 4½ Nickel-Plated Fuller Cock, deduct \$3.00.

If without Nickel-Plated Connected Waste and Overflow, deduct \$2.50.

For Supply and Waste Fittings, see pages 200 to 207.

For Exterior Finish and Decorations, see pages 194 and 195.

Dimensions :

Width inside, 24 inches; width over rim, 30 inches; depth inside, 17 inches; height from floor to top of rim, 22½ inches; roll rim, 3 inches.

In Orders and Specifications give Plate Numbers and Sizes.

H. M. & S. PORCELAIN ENAMELED BATHS.

FLAT BOTTOM.



644-C.

With 3-inch Enameled Roll Rim and Wide Flat Bottom; Nickel-Plated No. 4½ Fuller Double Bath Cock, with ½-inch Iron Pipe Size Nickel-Plated Offset Supply Pipes and Nickel-Plated "Favorite" Bath Waste.

Code.....	Perfricate	Perfrigida	Perfringe	Perfulgur	Perfumist
Size, feet	4	4½	5	5½	6
Length over rim, inches.....	48	54	60	66	72
Length inside, inches.....	42	48	54	60	66
Each.....	\$41.50	42.00	45.25	49.25	54.75
Shipping weight crated, pounds.....	300	325	350	375	400
Shipping measurement, cubic feet.....	26	28⅓	31½	34¼	37

One in a crate.

If without Nickel-Plated Supply Pipes, deduct \$2.75.
 If without No. 4½ Nickel-Plated Fuller Cock, deduct \$3.00.
 If without Nickel-Plated "Favorite" Waste, deduct \$7.00.

For Supply and Waste Fittings, see pages 200 to 207.
 For Exterior Finish and Decorations, see pages 194 and 195.

Dimensions :

Width inside, 24 inches; width over rim, 30 inches; depth inside, 17 inches; height from floor to top of rim, 22½ inches; roll rim, 3 inches.

In Orders and Specifications give Plate Numbers and Sizes.

H. M. & S. PORCELAIN ENAMELED BATHS.

FLAT BOTTOM.



† 645-C.

With 3-inch Enameled Roll Rim and Wide Flat Bottom; Nickel-Plated, Bell Supply Fittings with Imperial Waste; ¾-inch Iron Pipe size Supply Pipes; Exterior Finished in No. 1 Zinc White and Three Gold Lines.

Code	Perfumond	Perfumuzi	Perfunard
Size, feet	5	5½	6
Length over rim, inches	60	66	72
Length inside, inches.....	54	60	66
Each, complete as described.....	\$69.00	73.00	79.00
Shipping weight crated, lbs.....	375	400	425
Shipping measurement, cubic feet.....	31½	34¼	37

If without Exterior Finish and Gold Bands, deduct \$19.00.

For Exterior Finish and Decorations see pages 194 and 195.

Dimensions:

Width inside, 24 inches; width over rim, 30 inches; depth inside, 17 inches; height from floor to top of rim, 22½ inches; roll rim, 3 inches.

† Carried in San Francisco only.

In Orders and Specifications give Plate Numbers and Sizes.

H. M. & S. PORCELAIN ENAMELED BATHS.

FLAT BOTTOM.



† 646-C.

With 3-inch Enameled Roll Rim and Wide Flat Bottom; Nickel-Plated Compression Top Supply Fittings; ½-inch Iron Pipe Size Supply Pipes; Nickel-Plated Connected Waste and Overflow, with Rubber Stopper.

Code.....	Perfuneeel	Perfunekt
Size, feet.....	5	5½
Length over rim, inches.....	60	66
Each, complete as described....	\$48.50	52.50
Shipping weight, lbs.....	350	375
Shipping measurement, cubic feet.....	31½	34¼

For Exterior Finish and Decorations, see pages 194 and 195.

Dimensions :

Width inside, 24 inches; width over rim, 30 inches; depth inside, 17 inches; height from floor to top of rim, 22½ inches; roll rim, 3 inches.

† Carried in San Francisco only.

In Orders and Specifications give Plate Numbers and Sizes.

H. M. & S. PORCELAIN ENAMELED BATHS.

NEW MODEL.



647-C.

With 3-inch Enameled Roll Rim and Wide Flat Bottom; Drilled for Double Bath Cock, 3 3/8-inch center to center of Supplies, Common Overflow and Waste Plug.

Code.....	Perfungi	Perfungor	Perfusive	Perfusum	Pergamos
Size, feet.....	4	4 1/2	5	5 1/2	6
Length over rim, inches.....	50	56	62	68	74
Length inside, inches.....	44	50	56	62	68
Each, as described.....	\$28.75	29.25	32.50	36.50	42.00
Shipping weight each, pounds.....	325	350	385	410	450
Shipping measurement, cubic feet.....	23 3/4	26 1/2	29	32 1/2	34 1/2

For Brass Horn Overflow with Nickel-Plated Strainer and Nickel-Plated Waste Plug with Rubber Stopper, add \$1.00.

For Supply and Waste Fittings, see pages 200 to 207.

For Exterior Finish and Decorations, see pages 194 and 195.

Dimensions :

Width inside, 24 1/2 inches; width over Rim, 30 1/2 inches; depth inside, 17 inches; height from floor to top of rim, 23 inches; roll rim, 3 inches.

In Orders and Specifications give Plate Numbers and Sizes.

H. M. & S. PORCELAIN ENAMELED BATHS.

"NEW MODEL."

**648-C.**

With 3-inch Enameled Roll Rim and Extension Rim at Fitting End; Nickel-Plated Top Supply Fittings, with Nickel-Plated Ideal Bath Waste.

Code.....	Pergolino	Pergratos	Pergularum
Size, feet.....	5	5 ½	6
Length over rim, inches.....	63 ½	69 ½	75 ½
Length inside, inches.....	56	62	68
Each, complete as described.....	\$59.00	64.00	69.00
Shipping weight, lbs.....	395	420	465
Shipping measurement, cubic feet.....	29	32 ½	34 ½

For Exterior Finish and Decorations, see pages 194 and 195.

Dimensions :

Width inside, 24 ½ inches; width over rim, 30 ½ inches; depth inside, 17 inches; height from floor to top of rim, 23 inches; roll rim, 3 inches.

In Orders and Specifications give Plate Numbers and Sizes.

H. M. & S. PORCELAIN ENAMELED BATHS.

NEW MODEL.



650-C.

With 3-inch Enameled Roll Rim and Extension Rim at Fitting End; Nickel-Plated Bell Supply Fittings with Ideal Waste.

Code.....	Periapto	Periastral	Periban
Size, feet	5	5½	6
Length over rim, inches.....	63½	69½	75½
Length inside, inches.....	56	62	68
Each, complete as described.....	\$59.00	64.00	69.00
Shipping weight, lbs.....	395	420	465
Shipping measurement, cubic feet.....	29	32½	34½

For Exterior Finish and Decorations, see pages 194 and 195.

Dimensions :

Width inside, 24½ inches; width over rim, 30½ inches; depth inside, 17 inches; height from floor to top of rim, 23 inches; roll rim, 3 inches.

In Orders and Specifications give Plate Numbers and Sizes.

H. M. & S. SPECIAL PORCELAIN ENAMELED BATHS.

ROUND BOTTOM.



652-C.

With 2½-inch or 3-inch Enameled Roll Rim, Round Bottom; Drilled for Double Bath Cock, 3¾ inches center to center of Supplies, Common Overflow and Waste Plug.

“HICKORY.” 2½-INCH ROLL RIM.

Code.....	Pericarpe	Perichese	Perichore	Periclem	Pericliter
Size, feet	4	4½	5	5½	6
Length over rim, inches	48	54	60	66	72
Length inside, inches.....	43	49	55	61	67
Each, as described.....	\$23.25	23.75	25.00	28.50	35.00
Shipping weight, lbs.....	270	300	325	355	400
Shipping measurement, cubic feet.....	21½	23¾	26	28½	31

“MENLO.” 3-INCH ROLL RIM.

Code.....	Pericrane	Periderm	Peridrome	Perigean	Perigoso
Size, feet	4	4½	5	5½	6
Length over rim, inches.....	48½	54½	60½	66½	72½
Length inside, inches.....	43	49	55	61	67
Each, as described.....	\$24.00	24.50	27.00	30.75	35.25
Shipping weight, lbs.....	280	300	310	340	420
Shipping measurement, cubic feet.....	21¾	24	26½	29	31¾

For Supply and Waste Fittings, see pages 200 to 207.

For Exterior Finish and Decorations, see pages 194 and 195.

Dimensions :

Width inside, 24 inches; width over rim, 30 inches; depth inside, 17 inches; height from floor to top of rim, 22½ inches.

In Orders and Specifications give Plate Numbers and Sizes.

H. M. & S. SPECIAL PORCELAIN ENAMELED BATHS.

ROUND BOTTOM.



653-C.

With 2½-inch or 3-inch Enameled Roll Rim, Round Bottom; No. 4½ Nickel-Plated Fuller Double Bath Cock, with ½-inch Iron Pipe Size Offset Supply Pipes; Nickel-Plated Connected Waste and Overflow, with Rubber Stopper and Nickel-Plated Chain.

“HICKORY.” 2½-INCH ROLL RIM.

Code.....	Perigott	Perigoven	Perigowd	Perigoyle	Perigozam
Size, feet.....	4	4½	5	5½	6
Length over rim, inches.....	48	54	60	66	72
Length inside, inches.....	43	49	55	61	67
Each, complete as described.....	\$31.50	32.00	33.25	36.75	43.25
Shipping weight, lbs.....	280	310	335	365	410
Shipping measurement, cubic feet.....	21½	23¾	26	28½	31

“MENLO.” 3-INCH ROLL RIM.

Code.....	Perigrace	Perigraddo	Perigraft	Perigraket	Perigramme
Size, feet.....	4	4½	5	5½	6
Length over rim, inches.....	48½	54½	60½	66½	72½
Length inside, inches.....	43	49	55	61	67
Each, complete as described.....	\$32.25	32.75	35.25	39.00	43.50
Shipping weight, lbs.....	290	310	320	350	430
Shipping measurement, cubic feet.....	21¾	24	26½	29	31¼

If without Nickel-Plated Supply Pipes, deduct \$2.75.

If without No. 4½ Nickel-Plated Fuller Cock, deduct \$3.00.

If without Nickel-Plated Connected Waste and Overflow, deduct \$2.50.

For Supply and Waste Fittings, see pages 200 to 207.

For Exterior Finish and Decorations, see pages 194 and 195.

Dimensions:

Width inside, 24 inches; width over rim, 30 inches; depth inside, 17 inches; height from floor to top of rim, 22½ inches.

In Orders and Specifications give Plate Numbers and Sizes.

H. M. & S. SPECIAL PORCELAIN ENAMELED BATHS.

ROUND BOTTOM.



654-C.

With 2½-inch or 3-inch Enameled Roll Rim, Round Bottom; Nickel-Plated No. 4½ Fuller Double Bath Cock, with ½-inch Iron Pipe Size Nickel Plated Offset Supply Pipes; Nickel-Plated Favorite Bath Waste.

“HICKORY.” 2½-INCH ROLL RIM.

Code.....	Perigrasp	Perigreek	Perigrello	Perigenad	Perigreppi
Size, feet.....	4	4½	5	5½	6
Length over rim, inches.....	48	54	60	66	72
Length inside, inches.....	43	49	55	61	67
Each, complete as described.....	\$36.00	36.50	37.75	41.25	47.75
Shipping weight, lbs.....	285	315	340	370	415
Shipping measurement, cubic feet.....	21½	23¾	26	28½	31

“MENLO.” 3-INCH ROLL RIM.

Code.....	Perigrabel	Perigriggo	Perigrod	Perigrosse	Perigrouch
Size, feet.....	4	4½	5	5½	6
Length over rim, inches.....	48½	54½	60½	66½	72½
Length inside, inches.....	43	49	55	61	67
Each, complete as described.....	\$36.75	37.25	39.75	43.50	48.00
Shipping weight, pounds.....	295	315	325	355	435
Shipping measurement, cubic feet.....	21¾	24	26½	29	31¼

If without Nickel-Plated Supply Pipes, deduct \$2.75.

If without No. 4½ Nickel-Plated Fuller Cock, deduct \$3.00.

If without Nickel-Plated Favorite Waste, deduct \$7.00.

For Supply and Waste Fittings, see pages 200 to 207.

For Exterior Finish and Decorations, see pages 194 and 195.

Dimensions :

Width inside, 24 inches; width over rim, 30 inches; depth inside, 17 inches; height from floor to top of rim, 22½ inches.

In Orders and Specifications give Plate Numbers and Sizes.

H. M. & S. SPECIAL PORCELAIN ENAMELED BATHS.

FLAT BOTTOM.



655-C.

With 3-inch Enameled Roll Rim, Flat Bottom; Drilled for Double Bath Cock, 3 $\frac{3}{8}$ -inch center to center of Supplies, Common Overflow and Waste Plug.

“CALIFORNIA.” 3-INCH ROLL RIM.

Code.....	Perigsum	Perigual	Perigueux	Perihelion
Size, feet.....	4 $\frac{1}{2}$	5	5 $\frac{1}{2}$	6
Length over rim, inches.....	54 $\frac{1}{2}$	60 $\frac{1}{2}$	66 $\frac{1}{2}$	72 $\frac{1}{2}$
Length inside, inches.....	49	55	61	67
Each as described.....	\$24.50	27.00	30.75	35.25
Shipping weight, pounds.....	300	310	340	420
Shipping measurement, cubic feet.....	24	26 $\frac{1}{2}$	29	31 $\frac{1}{4}$

For Brass Overflow Horn with Nickel-Plated Strainer and Nickel-Plated Waste Plug and Coupling with Rubber Stopper and Chain, add \$1.00.

For Supply and Waste Fittings, see pages 200 to 207.

For Exterior Finish and Decorations, see pages 194 and 195.

Dimensions :

Width inside, 24 inches ; width over rim 30 inches ; depth inside, 17 inches ; height from floor to top of rim, 22 $\frac{1}{2}$ inches ; roll rim 3 inches.

In Orders and Specifications give Plate Numbers and Sizes.

H. M. & S. PORCELAIN ENAMELED BATHS.

FOR HOSPITALS, ASYLUMS AND SIMILAR INSTITUTIONS.

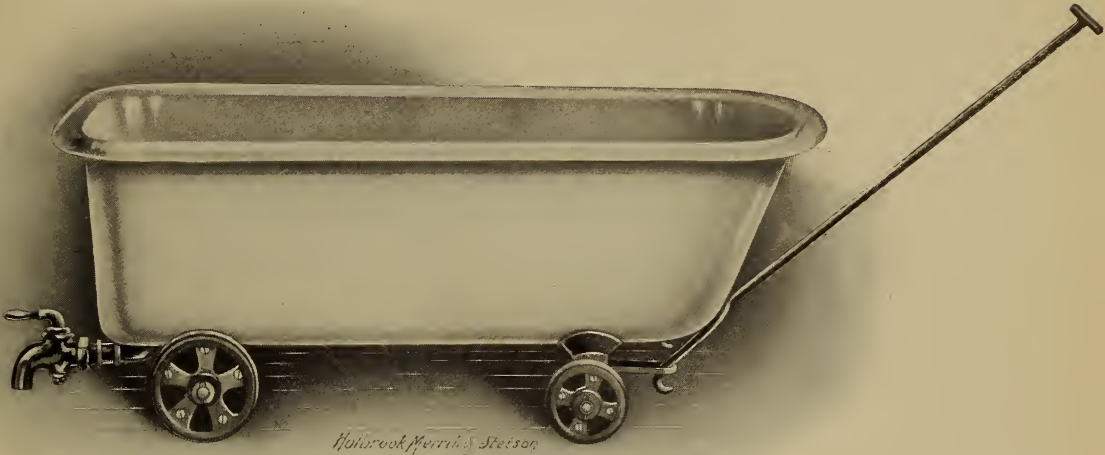

656-C.

With 2¾-inch Enameled Roll Rim ; Quick Opening Waste Valve ; Wrought Iron Carriage with Swiveled Axle ; Wrought Iron Draw Handle ; Rubber Tired Wheels ; Exterior Finished in Zinc White.

Code.....	Perikope	Perilles	Perilous
Size, feet.....	5	5½	6
Length over rim, inches.....	61½	67¾	72½
Length inside, inches.....	56	62	67
Each, complete as described.....	\$71.00	\$75.00	\$80.00
Shipping weight, pounds.....	350	375	400
Shipping measurement, cubic feet.....	27	29⅓	31⅔

If without Exterior Finish, deduct \$16.00.

For Exterior Finish and Decorations, see pages 194 and 195.

Dimensions :

Width inside, 24 inches ; width over rim, 29½ inches ; depth inside, 17 inches ; height from floor to top of rim, 23 inches ; roll rim, 2¾ inches.

In Orders and Specifications give Plate Numbers and Sizes.

H. M. & S. PORCELAIN ENAMELED SITZ BATHS.

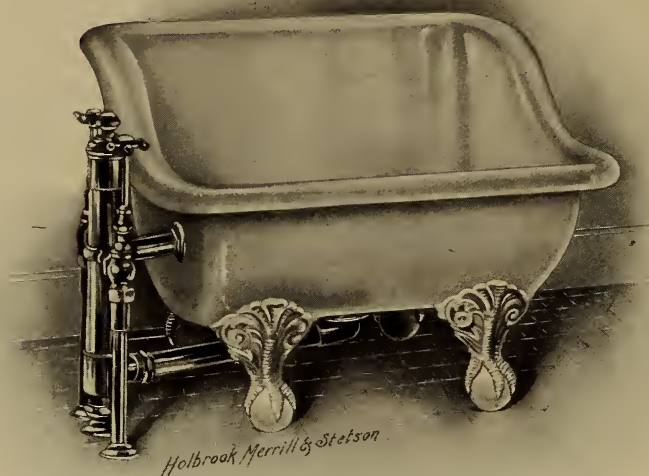

† 657-C.

With 3-inch Enameled Roll Rim; Nickel-Plated Bell Supply Fittings, with Imperial Waste; ½-inch Iron Pipe Size Supply Pipes.

Code.....	Perimela
Each, complete as described.....	\$47.00
Shipping weight, lbs.....	150
Shipping measurement, cubic feet.....	10½

If with Exterior Finished No. 1 Zinc White with Gold Lines, add \$12.50.

If with Exterior finished No. 1 Zinc White only, add \$10.50.

For Exterior Finish and Decorations, see pages 194 and 195.

Dimensions :

Front to back over rim, 27¾ inches; width over rim, 28½ inches; depth inside at waste hole, 10½ inches; height of front from floor to top of rim, 15 inches; height of back from floor to top of rim 20 inches; roll rim, 3 inches; center to center of supplies, 9 inches.

† Carried in San Francisco only.

In Orders and Specifications give Plate Numbers.

H. M. & S. PORCELAIN ENAMELED SITZ BATHS.**658-C.**

With 2½-inch Enameled Roll Rim and Extension Arm on side; Nickel-Plated Bell Supply Fittings with Imperial Waste; ½-inch Iron Pipe Size Supply Pipes.

Code	Periminel
Each, complete as described.....	\$47.50
Shipping weight, lbs.....	200
Shipping measurement, cubic feet.....	12½

If with Exterior finished No. 1 Zinc White and Gold Lines, add \$12.50.

For Exterior Finish and Decorations, see pages 194 and 195.

Dimensions :

Front to back over rim, 27½ inches; width over rim, 30 inches; depth inside at waste hole, 11 inches; height of front from floor to top of rim, 15 inches; height of back from floor to top of rim, 20 inches; roll rim, 2½ inches.

In Orders and Specifications give Plate Numbers.

H. M. & S. PORCELAIN ENAMELED NEW SITZ BATHS.



659-C.

With 3-inch Enameled Roll Rim and 5-inch Extension Side Arm; Nickel-plated Bell Supply Fittings with Imperial Waste; ½-inch Iron Pipe Size Supply Pipes; Exterior Finished in No. 1 Zinc White.

Code.....	Perinclito
Each, complete as described.....	\$65.50
Shipping weight, pounds.....	200
Shipping measurement, cubic feet.....	17

If without Exterior Finish, deduct \$10.50.

For Exterior Finish and Decorations, see pages 194 and 195.

Dimensions:

Front to back over rim, 31½ inches; width over extension rim, 34 inches; depth inside at waste hole, 10½ inches; height of front from floor to top of rim, 15 inches; height of back from floor to top of rim, 23 inches; roll rim, 3 inches; extension rim, 5 inches.

In Orders and Specifications give Plate Numbers.

H. M. & S. PORCELAIN ENAMELED FOOT TUBS.



660-C.

With 2½-inch Enameled Roll Rim; Nickel-Plated Bell Supply Fittings with Imperial Waste; ½-inch Iron Pipe Size Supply Pipes; Exterior Finished No. 1 Zinc White.

Code.....	Perinepti
Number.....	2
Each, complete as described.....	\$42.00
Shipping weight, pounds.....	175
Shipping measurement, cubic feet.....	10½

If without Exterior Finish, deduct \$8.00.

With Gold Lines, add \$1.50.

For Exterior Finish and Decorations, see pages 194 and 195.

Dimensions :

Length inside, 20 inches; length over rim, 25 inches; width over rim, 23 inches; width inside, 18 inches; depth inside, 13½ inches; height from floor to top of rim, 18 inches; roll rim, 2½ inches.

In Orders and Specifications give Plate Numbers.

BATH TUB DECORATIONS.

The exteriors of all Bath, Sitz and Foot Tubs and Receptors, unless otherwise specified, are unfinished and are painted with one coat of paint only. The process of finishing the exterior is of such a nature that it can be applied to better advantage at the factory, as the casting must be dressed and smoothed perfectly, which requires special facilities; and after each coat of the finish is applied it must be oven baked and hand-rubbed before the next succeeding coat is put on.

The number of coats varies from twelve to sixteen for the No. 1 finish and from six to ten for the No. 2 finish. After the exterior is entirely finished, if desired, gold lines or border decorations are added.

Gold bands or lines can be put on either No. 1 or No. 2 finish. Borders can be furnished on No. 1 finish only.

The No. 1 finish will be furnished on all orders for exterior finish unless otherwise specified, but can be furnished Ivory or Cream White if desired.

On the following page are shown a few of our regular border designs, which can be furnished in any color; we are also prepared to furnish, on reasonably short notice, special borders to match tiling or interior decorations.

Prices for Exterior Finish On Porcelain Enameled Baths.

No.		Code	On Foot Tubs and Receptors	Code	On Sitz Tubs	Code	On Bath Tubs
1	Zinc White Finish.....	Perineptos	\$ 8.00	Periploca	\$10.50	Perkaline	\$16.00
2	Zinc White Finish.....	Perinfame	6.00	Periplum	7.75	Perlaire	12.00
*	H. M. and S. Zinc White Finish.....	Peringrata	Periptere	Perlartig	15.00
	Gold Bands or Lines.....	Perinthum	1.50	Perisabor	2.00	Perlatrix	3.00
*	H. M. & S. Gold Bands or Lines.....	Perinvito	Periscole	Perlborn	5.00
1	Finish with 662-c Fleur-de-Lis Border	Periodico	11.50	Perissad	16.75	Perlegunt	23.00
1	Finish with 664-c Greek Border.....	Periödiste	11.50	Perissent	16.75	Perlette	23.00
1	Finish with 666-c Festoon Border.....	Periodo	13.50	Peristilo	19.75	Perlevis	27.00
1	Finish with 668-c Flower Border.....	Periodure	15.50	Peristyle	22.75	Perlfarbe	31.00
1	Finish with 670-c Poppies Border.....	Peripheral	16.50	Peritanza	24.25	Perlgrau	33.00
1	Finish with special border to match tiling, etc.....	Periplast	16.50	Perjuraba	24.25	Perlgries	33.00

*H. M. & S. Zinc White Finish, unlike No. 1 and No. 2 finish, is not baked on, there being no facilities on this coast. It is, however, a beautiful, smooth white hard finish.

Prices for Exterior Finish on "Ideal" Solid Porcelain Baths.

	Code	On Sitz Tubs	Code	On Bath Tubs
Zinc White Finish.....	Perlhirse	\$10.00	Perligor	\$15.00
Gold Bands or Lines.....	Perlrigent	2.00	Perlimes	4.00

Any Porcelain Bath may be decorated with regular or special designs. Prices upon application.

In Orders and Specifications give Plate Numbers and Color.

BATH TUB DECORATIONS.



662-C. Fleur-de-lis.



664-C. Greek Design.



666-C. Festoon Design.

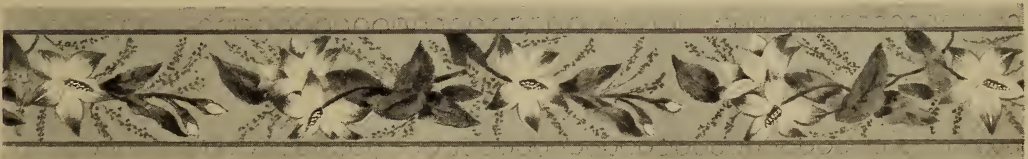

668-C. Flower Design.



670-C. Poppies Design.

In Orders and Specifications give Plate Numbers and Color.

STEEL CLAD BATH TUBS.

STEEL SHELL LINED INSIDE.

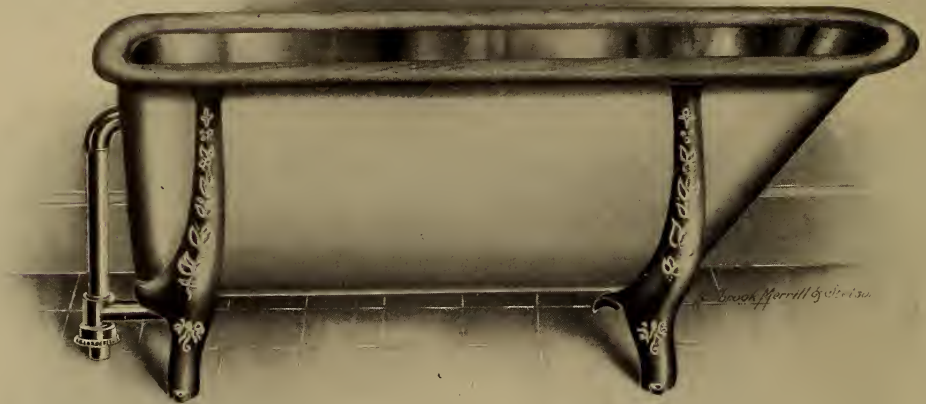

672-C.

With 3-inch Varnished Oak Rim, cut for Double Bath Cock, 3 $\frac{3}{8}$ inches center to center of Supplies; Nickel-Plated Connected Waste and Overflow with Chain and Plug; Exterior finished in Sky Blue, relieved with Gold Bronze.

STEEL CLAD WITH NICKEL-PLATED COPPER LINING.

Code.....	Perliquid	Perlkorn	Perlmaus
Size, feet.....	5	5$\frac{1}{2}$	6
Length over rim, inches.....	59 $\frac{1}{2}$	65	71 $\frac{1}{2}$
Length inside, inches.....	54 $\frac{1}{2}$	60	66 $\frac{1}{2}$
Each.....	\$25.50	26.50	28.50
Shipping weight each, pounds.....	93	100	109
Shipping measurement, cubic feet.....	25	27 $\frac{1}{2}$	30

STEEL CLAD WITH NICKELOID LINING.

Code.....	Perlonga	Perlsand	Perlstein
Size, feet.....	5	5$\frac{1}{2}$	6
Length over rim, inches.....	59 $\frac{1}{2}$	65	71 $\frac{1}{2}$
Length inside, inches.....	54 $\frac{1}{2}$	60	66 $\frac{1}{2}$
Each.....	\$25.50	26.50	28.50
Shipping weight each, pounds.....	95	102	111
Shipping measurement, cubic feet.....	25	27 $\frac{1}{2}$	30

Dimensions:

Width inside, 23 inches; width outside, 28 inches; depth inside, 17 $\frac{1}{2}$ inches; height from floor to top of rim, 22 inches.

For Supply and Waste Fittings, see pages 200 to 207.

In Orders and Specifications give Plate Numbers and Sizes.

H. M. & S. STEEL BATH TUBS.

WHITE ENAMEL INSIDE BAKED ON.



674-C.

With 3-inch Varnished Oak Rim, cut for Double Bath Cock, $3\frac{3}{8}$ inches center to center of Supplies; Nickel-Plated Connected Waste and Overflow, with Chain and Plug. Exterior finished in Sky Blue, relieved with Gold Bronze.

Code.....	Perlthee	Perluete	Perlustro	Perlutura
Size, feet.....	4½	5	5½	6
Length over rim, inches.....	53½	59½	65	71½
Length inside, inches.....	48½	54½	60	66½
Each.....	\$19.50	20.50	21.50	24.50
Shipping weight, lbs.....	72	76	80	86
Shipping measurement, cubic feet.....	22½	25	27½	30

For Supply and Waste Fittings, see pages 200 to 207.

Dimensions :

Width inside, 23 inches; width over rim, 28 inches; depth inside, $17\frac{1}{2}$ inches; height from floor to top of rim, 22 inches.

In Orders and Specifications give Plate Numbers and Sizes.

STEEL BATH TUBS.

WHITE ENAMEL INSIDE AND OVER RIM BAKED ON.



†676-C.

With 3-inch Pressed Steel Roll Rim; Cut for Double Bath Cock $3\frac{3}{8}$ inches center to center of Supplies; Nickel-Plated Connected Waste and Overflow with Chain and Plug. Pressed Steel Legs; Exterior is finished with one coat of dark metalatic paint.

Code.....	Perlweiss	Permacer
Size, feet.....	5	5½
Length over rim, inches	60	66
Each.....	\$24.00	\$25.00
Shipping weight, pounds.....	70	75
Shipping measurement, cubic feet....	25	27½

Dimensions :

Width inside, 23 inches; width over rim, 28 inches; depth inside, 17½ inches; height from floor to top of rim, 21 inches.

For Supply and Waste Fittings see pages 200 to 207.

† Carried in San Francisco only.

In Orders and Specifications give Plate Numbers and Sizes.

H. M. & S. ZINC BATH TUBS.

REDWOOD BOXES LINED WITH No. 10 ZINC.

CUT FOR OVERFLOW AND WASTE PLUG.

**678-C.**

Code.....	Permaduit	Permagni	Permeator
Size, feet.....	5	5½	6
Length inside, inches.....	57	63	69
Each.....	\$10.00	10.00	10.00
Shipping weight, pounds.....	100	110	120
Shipping measurement, cubic feet.....	16⅔	18½	20

With 1½-inch Brass Waste Plug and Chain and 6 inches 1½-inch Lead Pipe, put in, add \$1.00.

With 3-inch Fancy Brass Overflow Strainer and 1-inch Elbow for Lead Pipe, put in, add \$1.00.

With Galvanized Iron Pipe, Connected Waste and Overflow, Brass Waste Plug and Rubber Stopper, Brass Overflow Strainer and Bath Chain, Outlet Connection, 1½-inch Female Iron Pipe Thread, add \$5.10.

For Supply and Waste Fittings, see pages 200 to 207.

Dimensions :

Width inside, 22 inches; width outside, 24 inches; depth inside, 17¾ inches; height from floor to top, 19¾ inches; center of outlet to outside of end, 5¾ inches.

Special styles and sizes of Zinc Bath Tubs to order. Prices on application.

In Orders and Specifications give Plate Numbers and Sizes.

COMPRESSION DOUBLE BATH COCKS.

BRASS. NICKEL-PLATED.

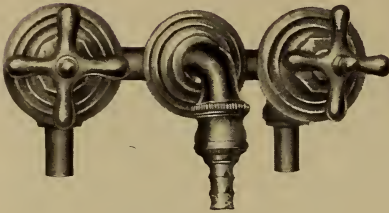

690-C.

5½-inch Centers. Tail Pieces for ½-inch Lead Pipe.

Code.....	Permesso
Number.....	5
Each	\$3.50
Weight each, lbs.....	3½
One in a box.	



691-C.

3¾-inch Centers. Threaded for ¾-inch Iron Pipe. Tail Pieces for ½-inch Lead Pipe.

Code.....	Permian
Number.....	3
Each	\$2.75
Weight each, lbs.....	3½
One in a box.	

No. 4½ FULLER DOUBLE BATH COCKS.

BRASS. NICKEL-PLATED.

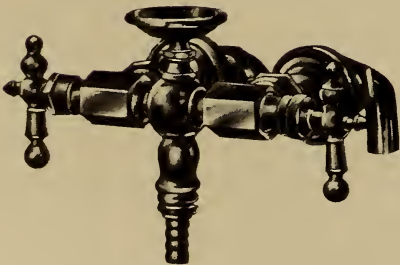

694-C.

3¾-inch Centers. Threaded for ¾-inch Iron Pipe. Tail Pieces for ¾-inch Lead Pipe.

Code				
Permigo	No. 4½.	Couplings for ¾-inch Lead Pipe.	Weight each, 4½ lbs.....	Each, \$3.00
Permissif.....	No. 4½.	Couplings for ½-inch I. P., Male.	Weight each, 4½ lbs.....	" 3.15
Permitido	No. 4½.	N. P. all over. Coupling for ¾-in. I. P., Female.	Wt. ea., 4½ lbs.	" 3.25
Permodill	No. 4½.	No Couplings with N. P. Locknuts.	Weight each, 4½ lbs.....	" 3.00
Permolo.....	No. 4½.	With Square Soap Cup, add to above prices		" 1.00
One in a box.				

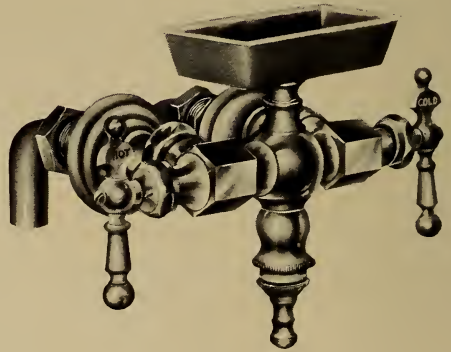

695-C.

With Square Soap Cup.

In Orders and Specifications give Plate Numbers.

No. 7 FULLER DOUBLE BATH COCKS.

BRASS NICKEL-PLATED.



696-C.

3 3/8-inch Centers, Threaded 3/4-inch Iron Pipe. Tail Pieces for 5/8-inch Lead Pipe.

Code.....	No. 7 —Couplings for 3/8-inch Lead Pipe. Weight, each, 3 3/8 lbs.....	Each,	\$2.25
Permotas.....	No. 7 —Couplings for 1/2-inch Iron Pipe, Male. Weight, each, 3 3/8 lbs.....	“	2.40
Permutant.....	No. 7 —Nickel-Plated all over. Couplings 3/8-inch Iron Pipe, Female. Weight, each, 3 3/8 lbs.....	“	2.50
Permuteur.....	No. 7 —No Couplings, with Nickel-Plated Locknuts. Weight, each, 3 3/8 lbs..	“	2.25
	One in a box.		

FULLER DOUBLE BATH COCKS.

FULLER DOUBLE BATH BIBBS.

IMPROVED PATTERN.

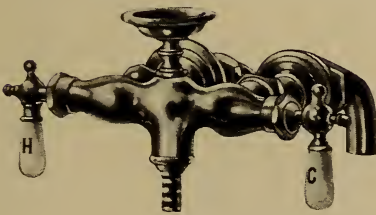

697-C.

3 3/8-inch Centers. With China Index Handles and Tail Pieces for Lead Pipe.

Code.....	Permux
Each.....	\$4.00
Weight, each, lbs.....	5

One in a box.

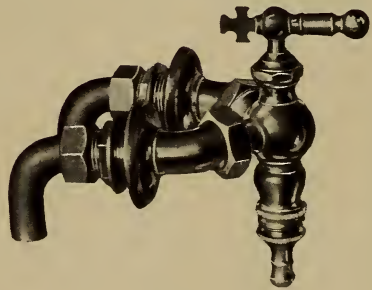

698-C.

3 3/8-inch Centers. Threaded for 3/4-inch Iron Pipe. Tail Pieces for 3/4-inch Lead Pipe.

Code.....	Permuzz
Each.....	\$2.50
Weight, each, lbs.....	3

One in a box.

In Orders and Specifications give Plate Numbers.

BATH COCK COUPLINGS.



700-C.

FOR LEAD PIPE.
ROUGH BRASS.

Code.....	Pernalto
Size, inch.....	5/8
Per pair.....	\$0.50



701-C.

FOR IRON PIPE, MALE.
ROUGH, NICKEL-PLATED.

Code.....	Pernarios
Size, inch.....	1/2
Per pair.....	\$0.60



702-C.

FOR IRON PIPE, FEMALE.
FINISHED NICKEL-PLATED.

Code.....	Pernavigo
Size, inches.....	3/8
Per pair.....	\$0.80

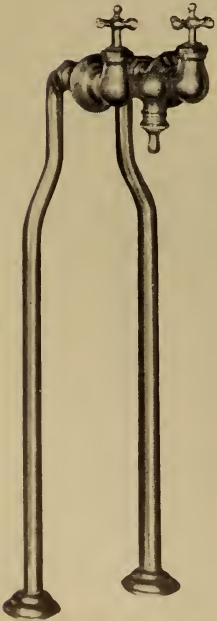

706-C.

COMPRESSION BATH COCK.

WITH SUPPLY PIPES.

No. 3 Nickel-Plated Compression Double Bath Cock with 1/2-inch Iron Pipe size, Nickel-Plated Offset Supply Pipes.

Code.....	Pernicity	Pernicone
	With Offset Pipes	With Straight Pipes
Price complete.....	\$5.50	5.25
Weight each, lbs.....	6 3/4	6 3/4

Center to center for Offset Supply Pipes, 5 3/4 inches.

Center to center for Straight Supply Pipes, 3 3/8 inches.

In Orders and Specifications give Plate Numbers.

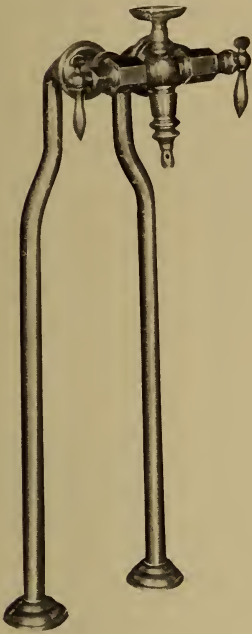

707-C.

FULLER BATH COCK.

WITH SUPPLY PIPES.

No. 4½ Nickel-Plated Fuller Double Bath Cock with ½-inch Iron Pipe size, Nickel-Plated Offset Supply Pipes.

Code.....	Perniger With Offset Pipes	Pernigros With Straight Pipes
Price complete.....	\$5.75	5.50
Weight, lbs.	7½	7½

Center to center for Offset Supply Pipes, 5¾ inches.

Center to center for Straight Supply Pipes, 3¾ inches.

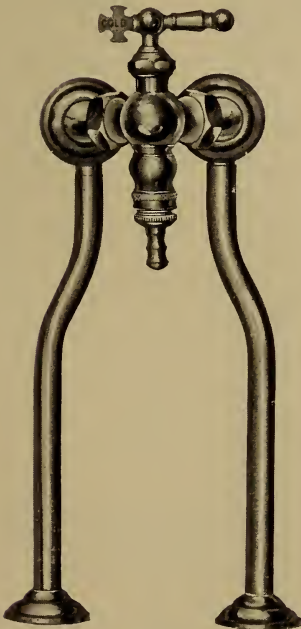

708-C.

FULLER DOUBLE BATH BIBB.

WITH SUPPLY PIPES.

Nickel-Plated Fuller Double Bath Bibb with ½-inch Iron Pipe Size, Nickel-Plated Offset Supply Pipes.

Code	Perniss With Offset Pipes	Pernistay With Straight Pipes
Price complete.....	\$5.00	4.75
Weight, lbs.....	6½	6½

Center to center for Offset Supply Pipes, at floor, 5¾ inches.

Center to center for Straight Supply Pipes, at floor, 3¾ inches.

In Orders and Specifications give Plate Numbers.

NICKEL-PLATED CONNECTED WASTE AND OVERFLOW.

ADJUSTABLE.

Cast Brass Strainer, Plug and Nuts. Nickel-Plated Chain and Rubber Stopper.



714-C.

Code.....	Peroolo
Size, inches.....	1 3/8
Each.....	\$2.50
Weight each, pounds.....	3 1/2

This Waste will fit Tubs that vary from 4 1/2 to 6 1/2 degrees, which covers over 90% of the Enameled Tubs on the Market.

One in a box.

FAVORITE NICKEL-PLATED BATH WASTE.

ADJUSTABLE.



715-C.

Code.....	Peropaco
Each.....	\$7.00
Weight each, pounds.....	6 1/4

One in a box.

For Rim Flanges, add \$1.00.

For China Name Plate, add \$0.50.

In Orders and Specifications give Plate Numbers.

COMMON OVERFLOW AND WASTE FITTINGS.

BRASS. OVERFLOW HAS NICKEL-PLATED STRAINER. WASTE HAS RUBBER STOPPER.

Code.....	Peroram
Per set	\$1.00
Weight, per set, lbs.....



716-C.

BATH TRAPS VENTED.

BRASS NICKEL-PLATED.

To set on the floor with inlet for connected waste and overflow or exterior bath waste.

Tube at inlet of trap is 1½-inch outside diameter.

These traps are so made that drain cocks may be put in.

Code.....	Perorell
Inch	1½
Each.....	\$6.50
Weight, each, lbs.....

One in a box.

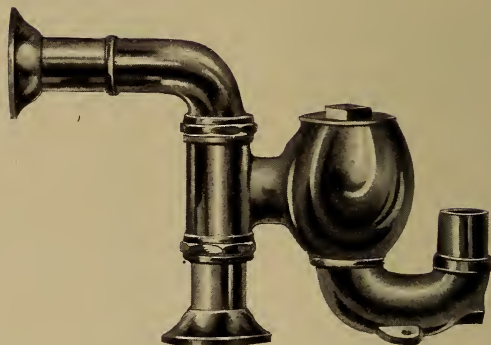

717-C.

BATH TRAPS.

BRASS NICKEL-PLATED.

1½-inch Connected Waste and Overflow with Rubber Stopper and Vented "S" Trap.

Code.....	Perorude
Each, as described.....	\$6.50
Weight, each, lbs.....

One in a box.

If without vent, deduct \$0.50.

If without Connected Waste, deduct \$2.50.



718-C.

In Orders and Specifications give Plate Numbers.

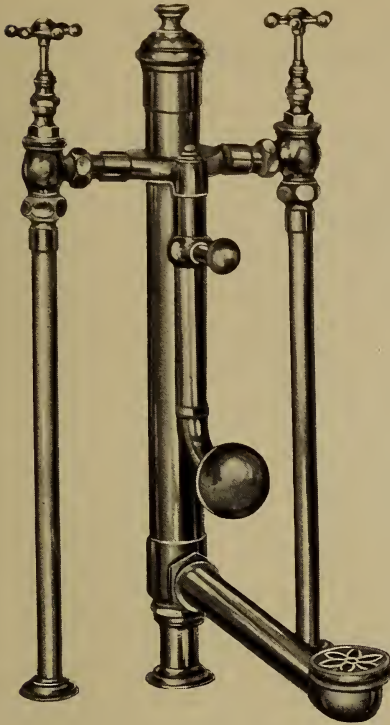

719-C.

† **NICKEL-PLATED BATH BELL
SUPPLY AND WASTE.**

ADJUSTABLE.

Supply Pipes 1/2-inch Iron Pipe size.

Code	Peroscele
Number.....	5
Each.....	\$17.00
Weight each, pounds.....	17 1/2

For 3/4-inch Iron Pipe size Supplies, add \$1.00

For Tub Rim Flanges, add \$2.00

For China Name Plates, add \$1.25

For Unions on Supplies at floor, add \$1.00

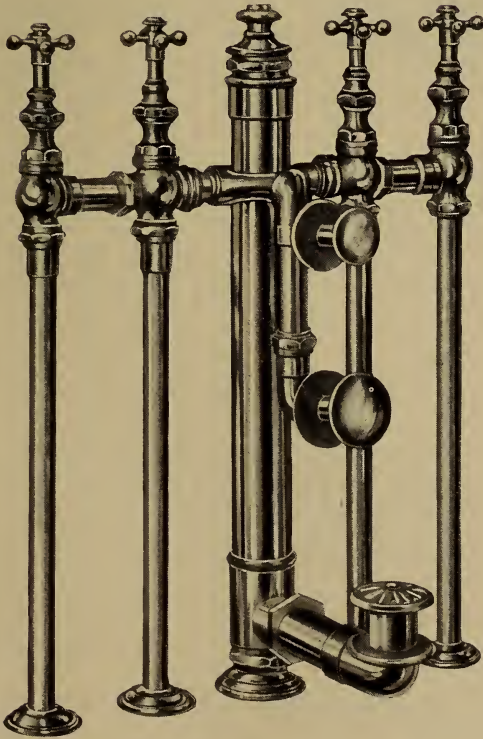

720-C.

† **NICKEL-PLATED BATH
BELL SUPPLY AND
WASTE.**

ADJUSTABLE.

Supply Pipes 3/4-inch Iron Pipe size. For hot and cold fresh water and hot and cold salt water.

Code	Perosum
Number.....	55
Each.....	\$33.00
Weight each, pounds.....	23

For China Name Plates, add \$2.00

For 3/4-inch Unions on Supply Pipes at floor add \$2.00.

† Carried in San Francisco only.

In Orders and Specifications give Plate Numbers.

† **PORCELAIN FLUSHING RIM BIDETS.**

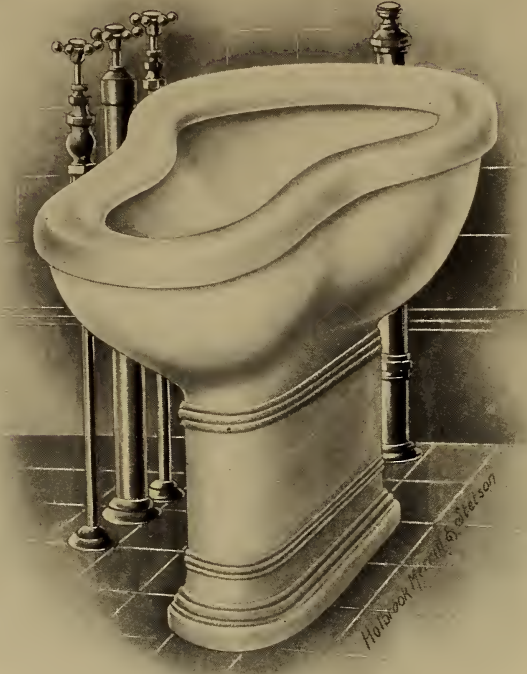

† **721-C.**

Solid Porcelain Flushing Rim Pedestal Bidet, Flushing Rim and Seat Integral; Nickel-plated Brass Compression Supply Fittings for hot and cold water, for the Spray or Douche, and Nickel-Plated Supply Valve for the Flushing Rim; Nickel-Plated Waste and Overflow.

Code.....	Perotot
Each complete as described.....	\$72.50
Weight each, lbs.....	65

Water may be retained in the bowl of the Bidet to nearly the height of the flushing rim, and by lifting the waste the water will run from the bowl as fast as supplied. By a single turn of the handle water may be immediately switched from the Bidet to the flushing rim.

Measurements:

Width outside at largest part, 14½ inches; width outside at smallest part, 12½ inches; length over all, 22½ inches; height from floor, 16 inches; from floor to center of connection, 8 inches; from center to rear of earthen ware, 7½ inches.

The space required for the proper setting of this Bidet, including fixtures, will not exceed 28x23 inches.

† Carried in San Francisco only.

In Orders and Specifications give Plate Numbers.

“IDEAL” SOLID PORCELAIN SHOWER BATH RECEPTORS.



Holbrook, Merrill & Stetson

722-C.

Square pattern Roll Rim Solid Porcelain Shower Bath Receptor, Glazed Pure White inside and outside with Waste in center; Nickel-Plated Strainer and Floor Flange.

Code.....	Peroxide	Perpacabo
Numbers.....	1	2
Outside dimensions, inches	36x36x9	42x42x9
Each, complete as shown.....	\$60.00	85.00
Shipping weight, lbs.....	310	420
Shipping measurement, cubic feet	12	14½

Above can be furnished with any Shower or Needle Bath.

In Orders and Specifications give Plate Numbers.

“IDEAL” SOLID PORCELAIN SHOWER BATH RECEPTORS.



724-C.

Corner Pattern Roll Rim Solid Porcelain Shower Bath Receptor, Glazed Pure White inside and outside with Waste in center; Nickel-plated Strainer and Floor Flange.

Code.....	Perparce
Each, complete as shown.....	\$105.00
Shipping weight, lbs.....	450
Shipping measurement, cubic feet.....	18

Dimensions:

Outside length on sides, 33½ inches; length from corner at back to front, 49 inches; depth, 9 inches.

Above can be furnished with any Shower or Needle Bath.

In Orders and Specifications give Plate Numbers.

“ MONARCH ” SOLID PORCELAIN SHOWER BATH RECEPTORS.



Halbrook Merrill & Stetson

726-C.

Round Pattern Roll Rim Solid Porcelain Shower Bath Receptor, Glazed Inside and Outside with Waste in Center; Nickel-Plated Strainer and Coupling.

Code	Perparvos	Perpastos
Size, inches.....	36	42
Each, complete as described.....	\$80.00	112.50
Weight each, lbs.....

Above Receptor can be furnished with any Shower or Needle Bath.

In Orders and Specifications give Plate Numbers and Sizes.

“MONARCH” SOLID PORCELAIN SHOWER BATH RECEPTORS.

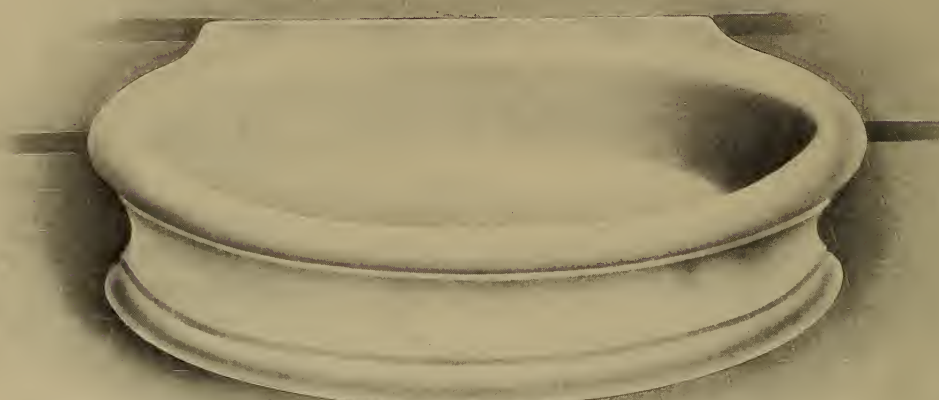

Holbrook, Merrill & Stetson

728-C.

Round Pattern Roll Rim Solid Porcelain Shower Bath Receptor, Glazed Inside and Outside, to Finish Against Wall, with Waste in Center; Nickel-Plated Strainer and Coupling.

Code.....	Perpastum	Perpaucos
Size, inches.....	36	42
Each, complete as described.....	\$93.00	125.50
Weight each, lbs.....

Above Receptors can be furnished with any Shower or Needle Bath.

In Orders and Specifications give Plate Numbers and Sizes.

**PORCELAIN ENAMELED SHOWER BATH
RECEPTORS.**

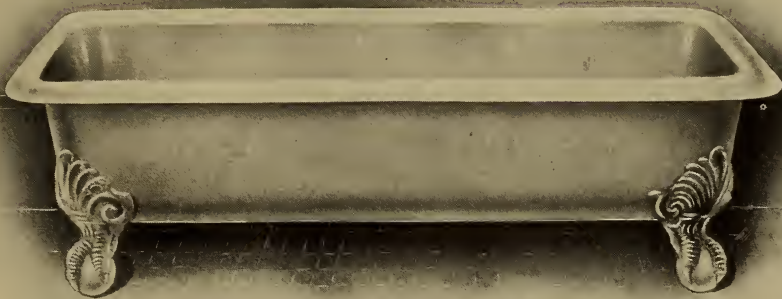

Holbrook, Kendall & Stinson.

730-C.

With Enameled Roll Rim; Nickel-Plated Strainer and Coupling.

Code.....	Perpaucum	Perpello
Size, inches.....	36	42
Each, complete as described.....	\$25.00	35.00
Weight each, lbs.....	240	315
Shipping measurement, cubic feet.....	9¼	14⅔

For Exterior Finish and Decorations see pages 194 and 195.

Dimensions :

36-inch size: Width over rim, 36 inches; length over rim, 36 inches; depth at waste hole, 6 inches; roll rim, 1½ inches. 42-inch size: Width over rim, 42 inches; length over rim, 42 inches; depth at waste hole, 8 inches; roll rim, 2 inches.

Above Receptors can be furnished with any of the Shower or Needle Baths shown on following pages.

In Orders and Specifications give Plate Numbers and Sizes.

NEEDLE AND SHOWER BATHS.

NICKEL-PLATED. IRON PIPE SIZE BRASS TUBING.



756-C.

Nickel-Plated Combination Needle and Shower Bath with Check Valves in Supplies; Italian Marble Stall, 6 feet 6 inches high, 3 feet 2 inches square; back and sides 7/8 inch; Countersunk Base, 1 1/2 inch. Right and Left Sides polished both sides.

Code		
Perpetior	Complete as described	\$205.50
Perpetose	Complete less Marble Stall, Floor Slab and Strainer.....	85.00

For Nickel-Plated Waste Strainer and Coupling add \$5.00.

For Supply Pipes to Floor, add \$10.00.

Weight, complete as described, 1355 lbs.; weight, less marble, 175 lbs.

Measurements:

Center to center of supplies, 18 1/2 inches, center of supplies to floor, 54 1/2 inches; Supplies, 3/4 inch; diameter of shower head, 8 inches; diameter of needle shower, 38 inches; extreme height, 94 inches; distance from wall to center of shower head, 20 1/2 inches.

In Orders and Specifications give Plate Numbers.

NEEDLE AND SHOWER BATHS.

NICKEL-PLATED. IRON PIPE SIZE BRASS TUBING.



758-C.

Nickel-Plated Combination Needle and Shower Bath, with Check Valves in Supplies; Italian Marble Stalls, 6 feet 6 inches high, 3 feet 2 inches square; Back and Sides, $\frac{7}{8}$ inch; Countersunk Base, $1\frac{1}{2}$ inches. Right and Left Sides, polished both sides.

Code		
Perpetuo	Complete as described.....	\$170.50
Perpetune	Less Marble Stall, Floor Slab and Strainer.....	50.00
	For Nickel-Plated Waste Strainer and Coupling add \$5.00.	
	For Nickel-Plated Supplies to Floor add \$10.00.	

Weight complete as described, 1270 pounds; less marble, 90 pounds.

Measurements :

Center to center of supplies, $18\frac{1}{2}$ inches; center of supplies to floor, $54\frac{1}{2}$ inches; supplies, $\frac{3}{4}$ inch; diameter of shower head, 8 inches; extreme height, 94 inches; distance from wall to center of shower head, $20\frac{1}{2}$ inches.

In Orders and Specifications give Plate Numbers.

NEEDLE AND SHOWER BATHS.

NICKEL-PLATED. IRON PIPE SIZE BRASS TUBING.

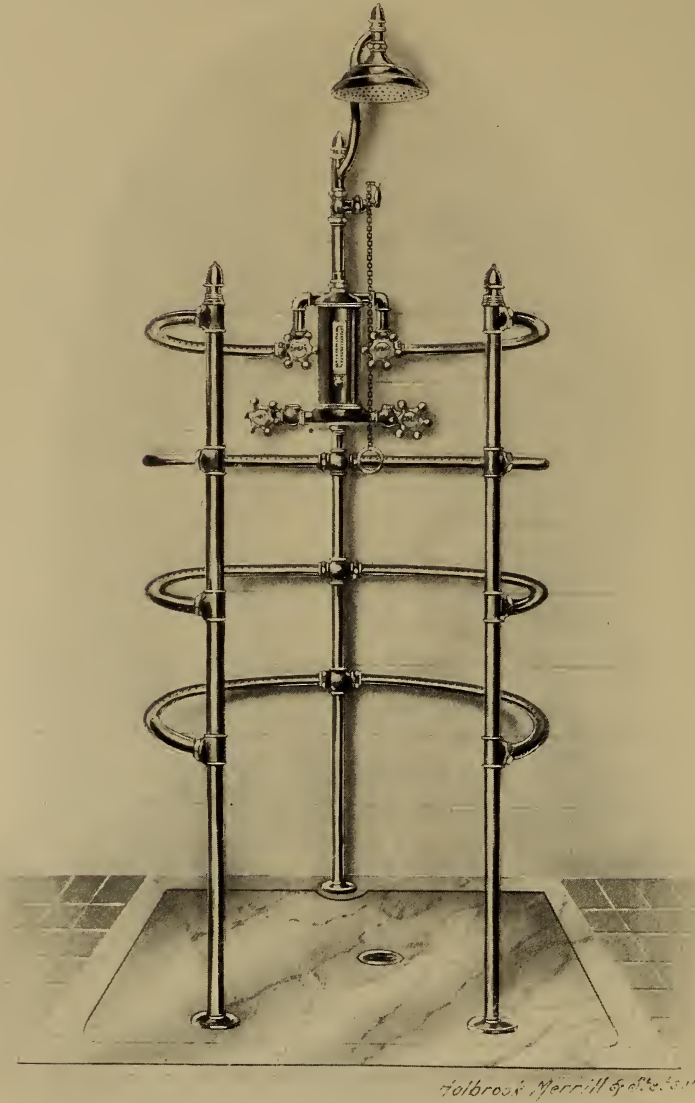

760-C.

Nickel-Plated Combination Needle and Shower Bath, with Mixing Chamber and Thermometer, with Check Valves in Supplies; 1½ inch Countersunk Italian Marble Floor Slab; 4 feet by 3 feet 9 inches.

Code		
Perpigner	Complete as described	\$170.00
Perpignide	Less Floor Slab.....	125.00

For Nickel-Plated Curtain Ring and Curtains add \$30.00. For Supply Pipes to floor add \$10.00.
For Nickel-Plated Waste Strainer and Coupling add \$5.00.

Weight, complete as described, 537 pounds; less floor slab, 200 pounds. One in a case.

Measurements :

Center to center of supplies, 12¾ inches; center of supplies to floor, 51½ inches; supplies, ¾ inch; diameter of shower head, 8 inches; diameter of needle shower, 38 inches; extreme height, 93 inches; distance from wall to center of shower head, 20½ inches.

In Orders and Specifications give Plate Numbers.

NEEDLE AND SHOWER BATHS.

NICKEL-PLATED. IRON PIPE SIZE BRASS TUBING.

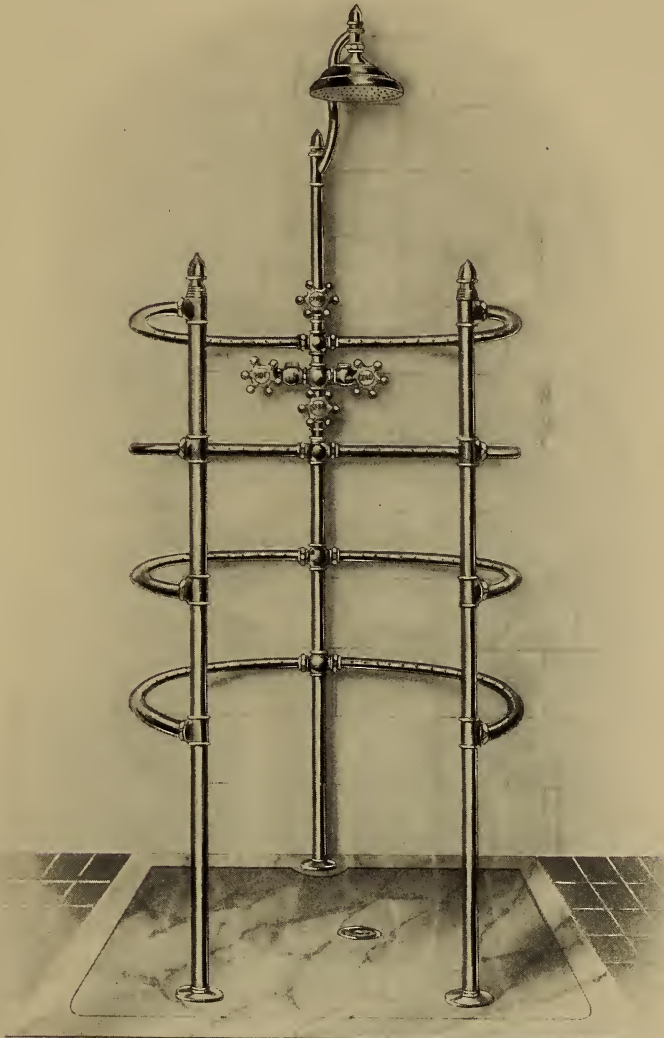

762-C.

Nickel-Plated Combination Needle and Shower Bath, with Check Valves in Supplies; 1½ inch Countersunk Italian Marble Floor Slab, 4 feet by 3 feet 9 inches.

Code	Complete as described.....	\$145.00
Perplaceo	Complete less Floor Slab.....	100.00

For Nickel-Plated Waste Strainer and Coupling, add \$5.00.

For Nickel-Plated Supply Pipes to Floor, add \$10.00.

Weight complete as described, 517 pounds; weight less Marble Slab, 180 pounds.
One in a case.

Measurements :

Center to center of supply pipes, 10 inches; center of supply pipes to floor, 54½ inches; supply pipes, ¾ inch; diameter of shower head, 8 inches; diameter of needle shower, 38 inches; extreme height, 93 inches; distance from wall to center of shower head, 20½ inches.

In Orders and Specifications give Plate Numbers.

SHOWER BATHS.

NICKEL-PLATED. IRON PIPE SIZE BRASS TUBING.

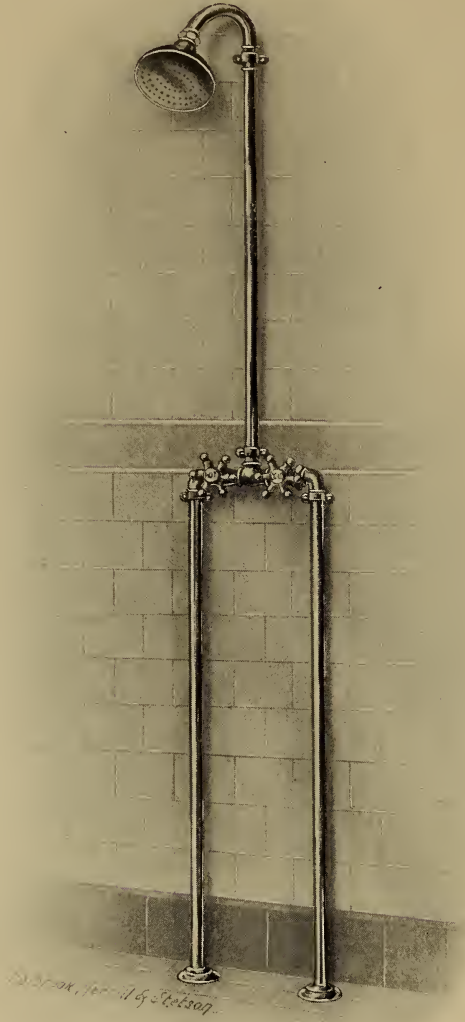

764-C.

Nickel-Plated Shower with Ball Joint to Regulate Angle of Spray, 3/8 inch Supplies and 1/2 inch Mixing Column.

Code.....	Perplesso
Complete as described.....	\$18.00
Weight each, lbs.....	29

One in a case.

Measurements :

Center to center of supplies, 9 1/4 inches; diameter of shower head, 5 inches; extreme height, 97 inches; distance from wall to center of shower head, 8 inches.

In Orders and Specifications give Plate Numbers.

SHOWER BATHS.

NICKEL-PLATED. IRON PIPE SIZE BRASS TUBING.



766-C.

Nickel-Plated Shower, with Shampoo Attachment, Curtain Ring and Duck Curtain; 1½ inch Countersunk Italian Marble Floor Slab, 27 inches by 27 inches; ½ inch Supplies and ¾ inch Mixing Chamber.

Code		
Perplicata	Complete as described.....	\$58.00
Perpluvia	Less Marble Floor Slab.....	41.50

For Nickel-Plated Waste Strainer and Coupling add \$5.00.

One in a case.

Weight complete as described, 173 pounds; weight less marble slab, 59 pounds.

Measurements :

Center to center of supplies, 9¼ inches; diameter of shower head, 8 inches; extreme height, 97 inches; diameter of curtain ring, 24 inches; distance from wall to center of shower head, 14½ inches.

In Orders and Specifications give Plate Numbers.

SHOWER BATHS.

NICKEL-PLATED. IRON PIPE SIZE BRASS TUBING.

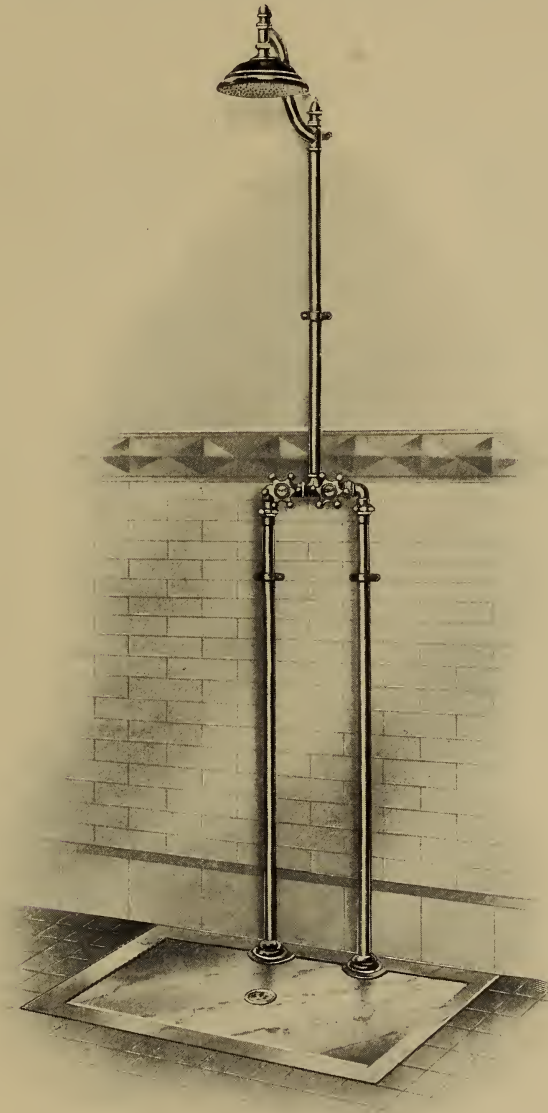

768-C.

Nickel-Plated Shower, with 1½-inch Countersunk Italian Marble Floor Slab, 27 inches by 27 inches; ½-inch Supplies and ¾-inch Mixing Column.

Code		
Perpolio	Complete as described	\$37.50
Perpopish	Less Marble Floor Slab.....	21.00

For Nickel-Plated Waste Strainer and Coupling add \$5.00.

Weight complete as described, 154 pounds; weight less marble slab, 40 pounds.
One in a case.

Measurements :

Center to center of supplies, 9¼ inches; diameter of shower head, 8 inches; extreme height, 97 inches; distance from wall to center of shower head, 14½ inches.

In Orders and Specifications give Plate Numbers.

SHOWER BATHS.

NICKEL-PLATED. IRON PIPE SIZE BRASS TUBING.



770-C.

“Niagara” Nickel-Plated Shower Bath, with Check Valves in Supply Pipes; Shampoo Sprinkler; White Duck Curtain.

Code.....	Perponte
Complete as described.....	\$30.00
Weight each, lbs.....	50

Measurements :

Center to center of supply pipes, 11 inches; supplies, ½-inch iron pipe size.

In Orders and Specifications give Plate Numbers.

BRACKET SHOWER BATH.

HEAVY BRASS. NICKEL-PLATED.

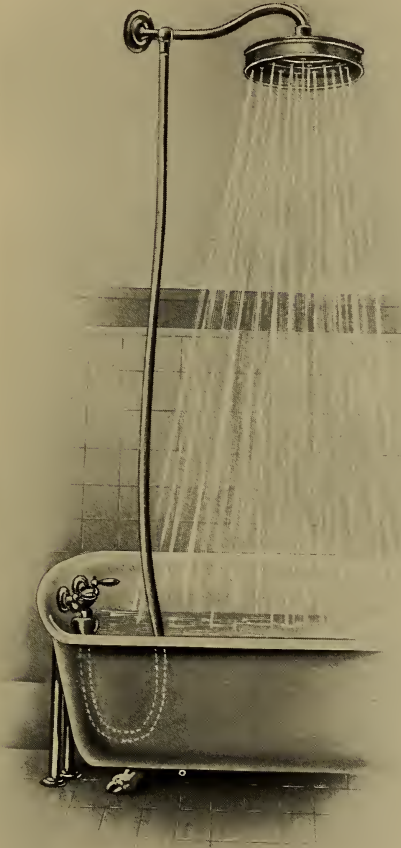

771-C.

With 7-inch Shower Head attached to Bracket with Flange for fastening to wall, and Rubber Tubing with Bulb Connection to fit any faucet.

Code.....	Perpoque
Each, complete as described.....	\$5.00
Shipping weight, lbs.....
Shipping measurement, cubic feet.....

SUNBURST SHOWER BATH.

HEAVY BRASS. NICKEL-PLATED.



773-C.

With 7-inch Shower Head provided with Arms to hold Curtain, 3/8-inch Supply Pipe and 6 feet of best Rubber Tubing with Rubber Bulb Connection to fit any faucet; 6 feet x 6 feet Rubber Back Curtain.

This is a portable Shower and a special feature is its compactness. The rods or arms holding curtain can be unscrewed and the whole fixture when taken apart, including curtain, pack in a box 22x12x3 inches.

Code	Perppent
Each, complete as described	\$14.00
Shipping weight, lbs.....
Shipping measurement, cubic feet...	1/2

One in a box.

In Orders and Specifications give Plate Numbers.

PORTABLE SHOWER BATHS.

FRAME MADE OF SEAMLESS BRASS TUBE. NICKEL-PLATED. RUBBER CURTAIN. MAY BE ATTACHED TO ANY TUB.

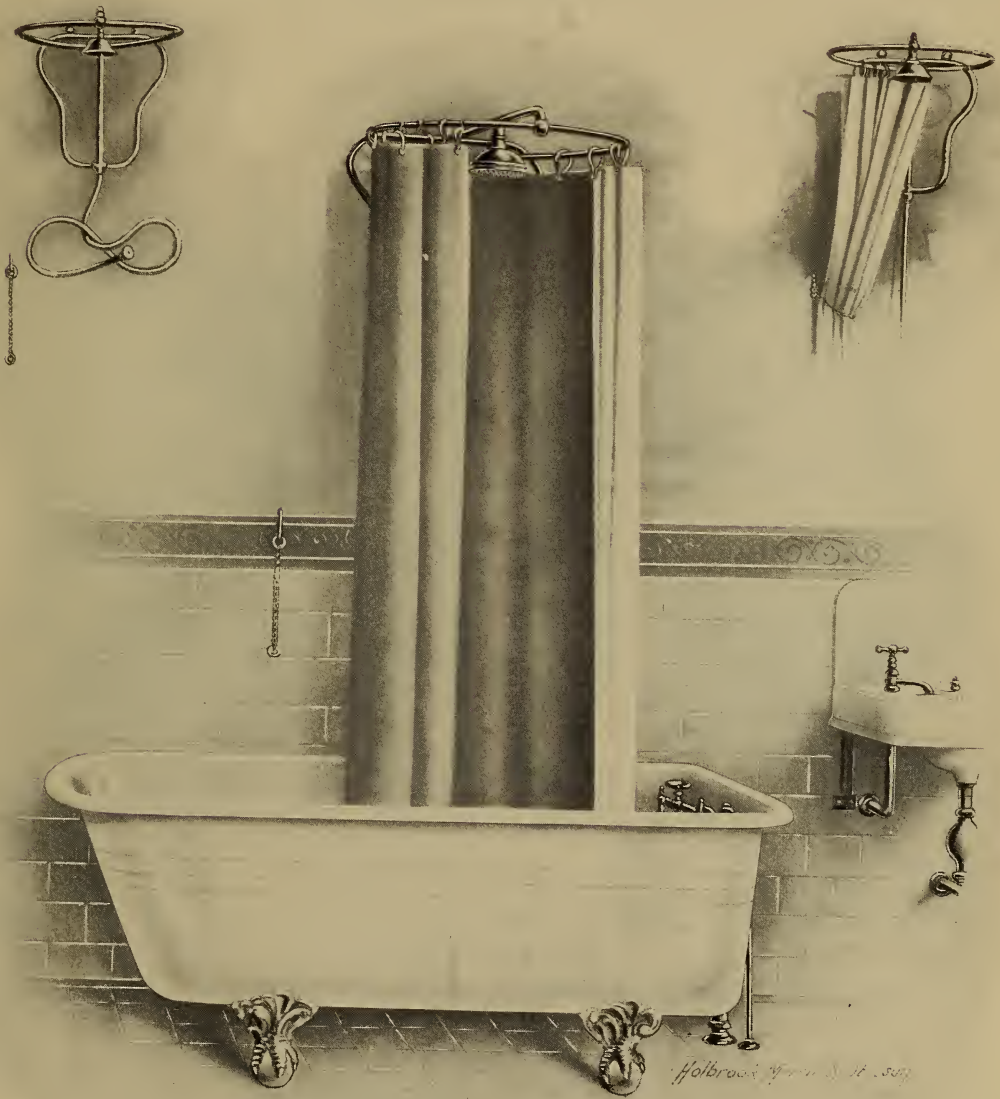

772-U.

Nickel-Plated Brass Frame and 5-inch Shower with Vent; 21-inch Nickel-Plated Curtain Ring; White Rubber Curtain and Curtain Snaps; Rubber Cap; Rubber Tubing with Attachment for Bath Faucet; Nickel-Plated Curtain Hook and Chain; Nickel-Plated Screws.

Code.....	Perpressi
Each, complete as described.....	\$15.00
Weight each, lbs.....	25
Shipping measurement each, cubic feet.....	1 3/8

One in a case.

The Portable Shower as shown above, is the latest design and construction of Portable Showers. It is easily put up and removed, can be packed in your trunk when you go away for your summer vacation, and is a boon to those who live in rented houses.

In Orders and Specifications give Plate Numbers.

SHOWERS.

BRASS NICKEL-PLATED. IRON PIPE SIZE BRASS TUBING.

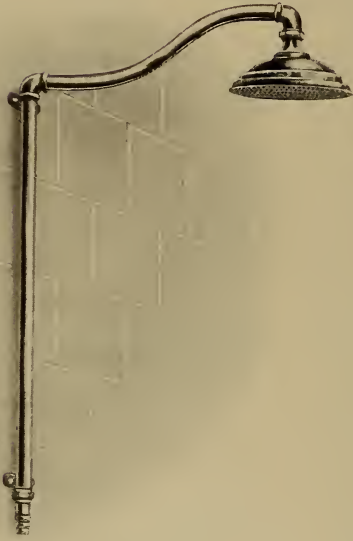

774-C.

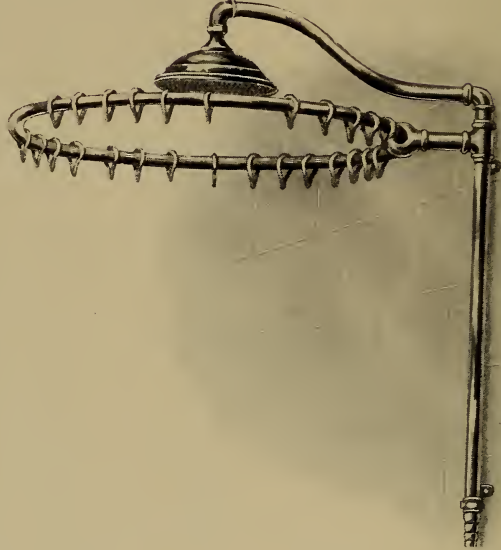

776-C.

Nickel-Plated Shower, for Rubber Hose to attach to Bath Cock or Faucet.

Nickel-Plated Shower, with 24-inch Curtain Ring and Snaps, for attaching to Bath Cock or Faucet.

Code.....	Perprim
Each.....	\$6.50
Weight each, lbs.....	18

Code.....	Perpulsi
Each.....	\$12.50
Weight each, lbs.....	30

Extreme height, 36 inches; diameter of shower head, 8 inches; distance from wall to center of shower head, 14½ inches.

Extreme height, 50 inches; diameter of shower head, 8 inches; distance from wall to center of shower head, 14½ inches.

One in a case.

In Orders and Specifications give Plate Numbers.

SHOWERS.

BRASS NICKEL-PLATED. IRON PIPE SIZE BRASS TUBING.



778-C.

Nickel-Plated Shower, with Self-Closing Valve, Chain and Ring Pull.

Code.....	Perpulsum
Each.....	\$8.50
Weight each, lbs.....	15

Diameter of shower head, 8 inches; distance from wall to center of shower head, 16 inches; supply, 1/2 inch.



780-C.

Nickel-Plated Shower, with Self-Closing Valve, Chain and Ring Pull.

Code.....	Perpunctos
Each.....	\$8.50
Weight each, lbs.....	15

Diameter of shower head, 8 inches; distance from ceiling to bottom of shower head, 18 inches; supply, 1/2 inch.

One in a case.

In Orders and Specifications give Plate Numbers.

SHOWERS.

BRASS NICKEL-PLATED. IRON PIPE SIZE BRASS TUBING.

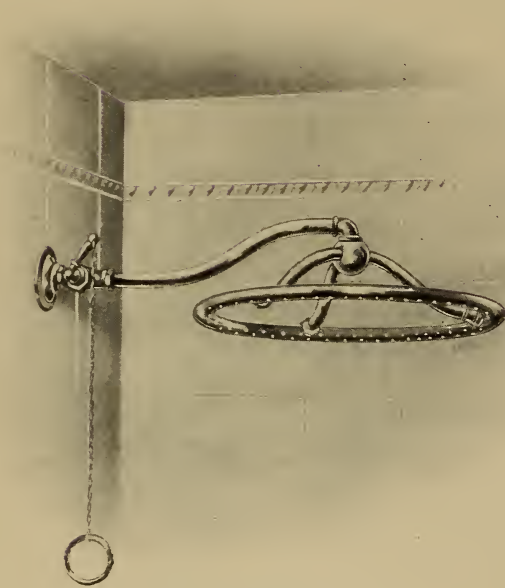

782-C.

Nickel-Plated Ring Shower with Self-Closing Valve; Chain and Ring Pull.

Code.....	Perputes
Each.....	\$12.00
Weight each, lbs.....	24

Diameter of ring, 20 inches; distance from wall to center of ring, 18 inches; supply, 1/2 inch.

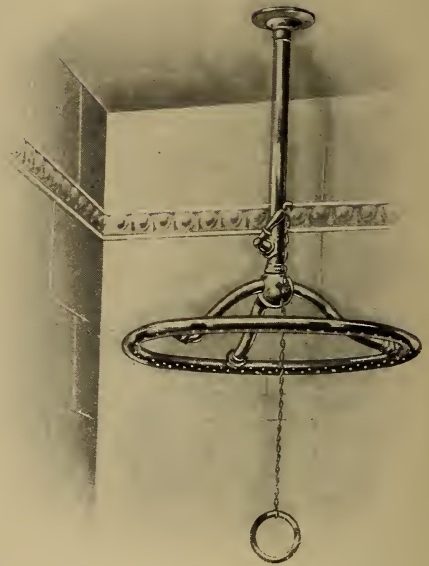

784-C.

Nickel-Plated Ring Shower with Self-Closing Valve; Chain and Ring Pull.

Code.....	Perquam
Each.....	\$12.00
Weight each, lbs.....	24

Diameter of ring, 20 inches; distance from ceiling to bottom of ring, 23 inches; supply, 1/2 inch.

One in a case.

In Orders and Specifications give Plate Numbers.

SHAMPOOS.

BRASS NICKEL-PLATED. IRON PIPE SIZE BRASS TUBING. FOR BATHS, RUBBING SLABS, ETC.

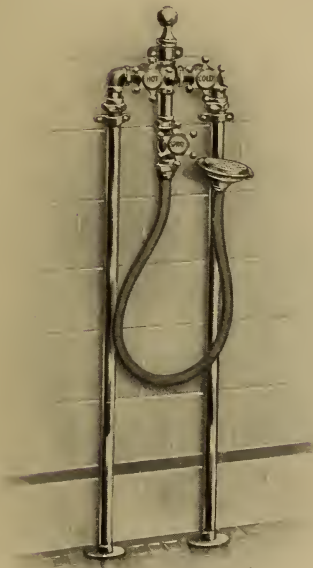

786-C.

Nickel-Plated Shampoo with Rubber Bound Sprinkler.

Code.....	Perquisite
Each.....	\$13.00
Weight each, lbs.....	21

Extreme height, 53 inches; supplies, 3/8 inch.



788-C.

Nickel-Plated Shampoo with Rubber Bound Sprinkler.

Code	Perquisite
Each.....	\$10.00
Weight each, lbs.....	11

Extreme height, 11 inches; supplies, 1/2 inch.

Center to center of supplies, 9 1/4 inches.

One in a case.

In Orders and Specifications give Plate Numbers.

OVERHEAD NEEDLE SHOWERS.

BRASS POLISHED AND NICKEL-PLATED.



† 790-C.

No. 30. Body is in one piece.



† 791-C.

No. 40. Body is in two parts.

Code.....	Perrazas	Perrengo
Diameter of face, in.....	6½	8
Iron pipe female thread, in.....	½	¾
Each	\$2.20	2.50
Weight each, lbs.....	1	1½

One in a box.

Code.....	Perrepes	Perrepunt
Diameter of face, in.....	6½	8
Iron pipe female thread, in.....	½ or ¾	½ or ¾
Each	\$3.40	4.00
Weight each, lbs.....	1½	2

One in a box.

These showers give a fine spray, which has a slightly irritative and yet very pleasant effect on the skin.

The valve in the showers allows the water to drain quickly.

No. 40 is in two parts, to allow of cleaning, should the small holes in the face of the shower become clogged. The screw joint is the same for all sizes.

† Carried in San Francisco only.

In Orders and Specifications give Plate Numbers and Sizes.

OVERHEAD TULIP SHOWERS.

OVERHEAD SHOWERS.

POLISHED BRASS NICKEL-PLATED.

POLISHED BRASS NICKEL-PLATED.



† 792-C.

With Removable Face.



† 793-C.

With Corrugated Face.

Code.....	Perriches
Number.....	50
Diameter, inches.....	4
Depth, inches.....	3½
Iron pipe female thread, inch.....	½
Each.....	\$2.00
Weight each, lbs.....	¾

One in a box.

Code.....	Perrimosi
Number.....	45
Diameter, inches.....	7¼
Depth, inches.....	1¾
Iron pipe female thread, inch.....	½
Each.....	\$1.50
Weight each, lbs.....	1¼

One in a box.

† Carried in San Francisco only.

In Orders and Specifications give Plate Numbers and Sizes.

SHOWER HEADS.

SPUN COPPER NICKEL-PLATED. CORRUGATED FACES.



794-C.
Plain.



795-C.
Tubular.

PLAIN SHOWER HEADS—794-C.

Code.....	Perrodetis	Perrogare	Perrogites	Perroquet	Perruche
Size, inches.....	† 4	† 5	6	7	8
For iron pipe thread, inch.....	3/8	3/8	1/2	1/2	1/2
Each.....	\$0.60	.75	.90	1.10	1.30
Weight each, lbs.....	1/2	3/4	1	1 1/4	1 3/4

One in a box.

† TUBULAR SHOWER HEADS—795-C.

Code.....	Perrumpo	Perrygine	Persalsum	Persaluto	Persancte
Size, inches.....	4	5	6	7	8
For iron pipe thread, inch.....	3/8	3/8	1/2	1/2	1/2
Each.....	\$1.05	1.35	1.60	2.00	2.50
Weight each, lbs.....	1/2	3/4	1	1 1/4	1 3/4

One in a box.

Special showers up to 18 inches in diameter made to order.

BALL JOINT SPRINKLER HEADS.

BRASS NICKEL-PLATED.
REMOVABLE FACE.



† 796-C.

Adjustable; Diameter, 4 inches;
1/2-inch Female Iron Pipe
Thread.

Code.....	Persapien
Each.....	\$5.75
Weight each, lbs.....	1 1/2

BALL AND SOCKET JOINTS.

BRASS NICKEL-PLATED.

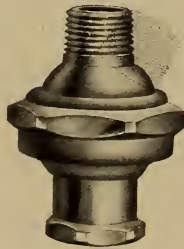

† 797-C.

Adjustable, with Iron Pipe
Threads.

Code.....	Persbaar	Persboom
Size, inch.....	1/2	3/4
Each.....	\$1.50	2.00
Weight, ea., lbs.....	1 1/16	1 1/16

BALL JOINT SHOWER HEADS.

EXTRA HEAVY CAST BRASS NICKEL-PLATED.
REMOVABLE FACE.



† 798-C.

Adjustable; Diameter, 6 inches;
1/2-inch Female Iron Pipe
Thread.

Code.....	Persbord
Each.....	\$8.25
Weight each, lbs.....	4

† Carried in San Francisco only.

In Orders and Specifications give Plate Numbers and Sizes.

SHAMPOO SPRAYS.

BRASS NICKEL-PLATED.

With Shank for $\frac{3}{8}$ -inch Rubber Tubing.



800-C.

Code.....	Perscindo
Number.....	51
Diameter of face, inches.....	2 $\frac{1}{4}$
Each.....	\$0.15
Weight per dozen, lbs.....	$\frac{3}{4}$
	Loose.

† **BATH SPRAYS.**

BRASS NICKEL-PLATED.

With Detachable Shank and Rubber Ring. Shank for $\frac{3}{8}$ -inch Rubber Tubing.

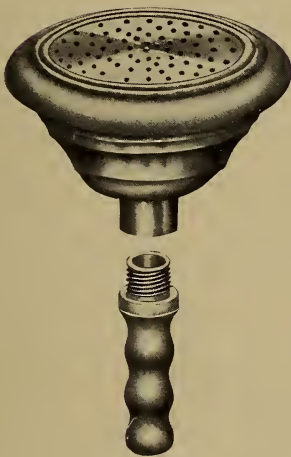

801-C.

Code.....	Perscisso
Number.....	70
Diameter of face, inches.....	2 $\frac{1}{2}$
Each.....	\$0.45
Weight per dozen, lbs.....	2 $\frac{3}{4}$
	Twelve in a box.

SURE GRIP BULBS.

NICKEL-PLATED BRASS AND HIGHEST GRADE RUBBER.

For connecting Bath Sprays or Shower Rings to any Pipe, Tube or Faucet, from three-eighths inch to seven-eighths inch diameter inclusive.

It holds securely and is far superior in every way to any other bulb made.

The Rubber in these Bulbs is guaranteed against cracking, splitting or hardening for ten years.

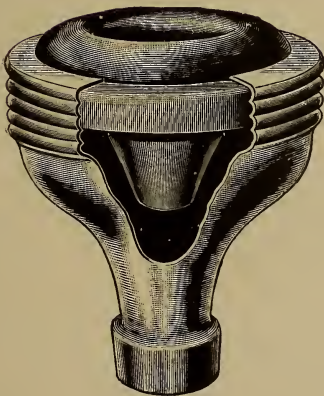

802-C.

Code.....	Perscitos
Each.....	\$0.45
Weight per dozen, lbs.....

† Carried in San Francisco only.

In Orders and Specifications give Plate Numbers.

KELLY SHOWER RINGS.

BRASS NICKEL-PLATED.

Heavy.



803-C.

Shank for 3/8-inch Rubber Tubing.

Code	Perscruto
Diameter, inches.....	† 10
Each.....	\$3.00
Weight each, lbs.....	1

One in a box.

NECK SHOWERS.

NICKEL-PLATED BRASS.



804-C.

Shank for 3/8-inch Rubber Tubing.

Code.....	Persicot
Inches.....	7 1/2 x 8
Each.....	\$0.80
Weight each, lbs.....	1/2

One in a box.

BATH SPRAYS.

WITH 5 FEET OF 3/8-INCH BEST QUALITY SMOOTH RUBBER TUBING.

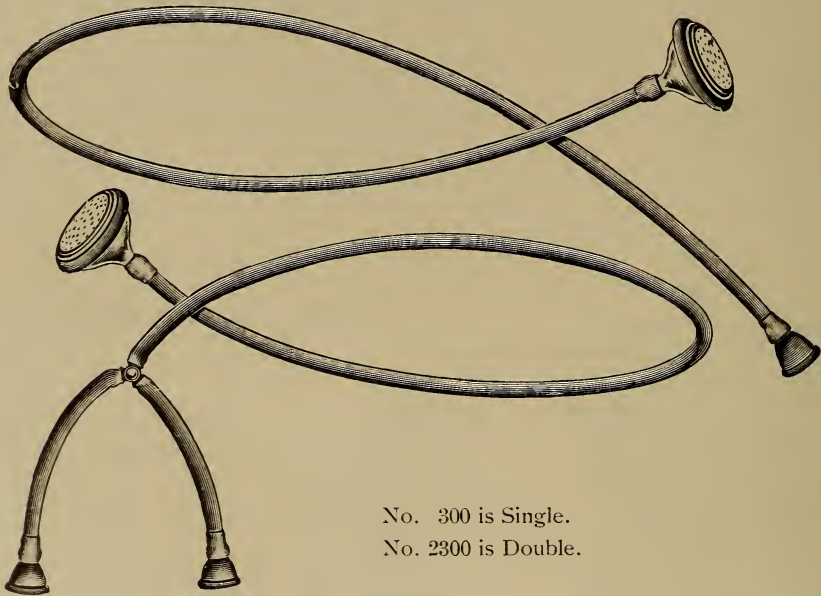

No. 300 is Single.
No. 2300 is Double.

805-C.

All metal work is brass, nickel-plated. The Sprays are 3 inches in diameter, with rubber buffer rings. The Rubber bulbs will grip faucets up to and including 3/4 inch.

Code	Persicules	Persiflage
Number.....	300	† 2300
Each.....	\$2.50	3.35
Weight each, lbs.....	1 1/2	1 3/4

One in a wooden box.

† Carried in San Francisco only.

In Orders and Specifications give Plate Numbers and Sizes.

MASSAGE BATH SPRAY.

SOFT WHITE RUBBER.

Brush and Spray Combined.

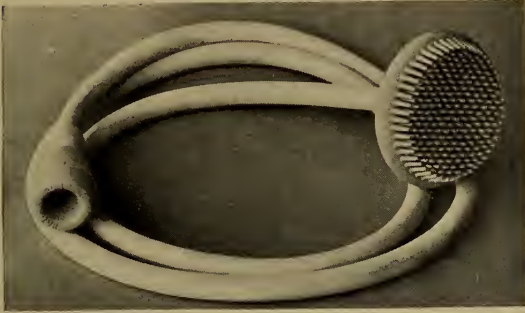

Code.....	Persilouve
Number.....	1
Length, inches.....	60
Diameter of spray, inches.....	3¼
Each.....	\$3.00
Weight each, lbs.....	1½

One in a box.

† 806-C.

The Massage Bath Spray is constructed so that it can be used as a Brush and Spray at the same time and attached to any faucet.

The Brush consists of soft rubber bristles. At the base of each bristle is a small hole which allows the water to flow past them, making a spray, the force of which can be regulated by the pressure of water. By using this spray you can begin taking your bath just as soon as you turn on the water, as it is unnecessary to have any water in the tub, thereby saving a great deal of time.

The Brush and Spray can be easily detached from the metal back, thoroughly cleaned and replaced. It is excellent to use for shampooing as it massages the head and rinses the hair. The rubber brush being of a soft, velvety nature, positively does not scratch the skin, as is the case with a bristle brush, and is more cleansing. It merely causes the blood to circulate freely, creates a glow and puts the pores of the body in a natural and healthy condition.

SHOWER RINGS.

With 5 feet of ¾ inch Best Quality Rubber Tubing.

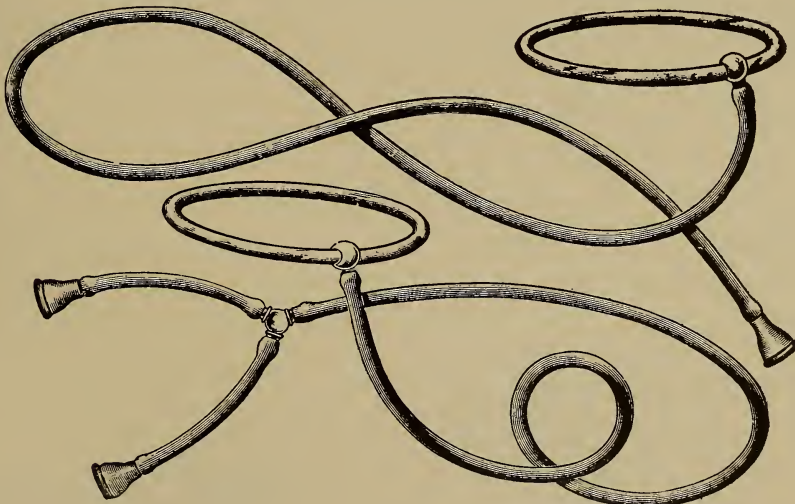

807-C.

All metal work is brass, nickel-plated. The rings are 12 inches in diameter. The bulbs will grip faucets up to and including ¾ inch.

Code	Persilutte	Persiluz
Numbers.....	30	230
Style	Single	Double
Each	\$2.50	3.35
Weight each, lbs	1½	2½

One in a wooden box.

† Carried in San Francisco only.

In Orders and Specifications give Plate Numbers.

SHOWER CURTAIN SNAPS.

BRASS NICKEL-PLATED.

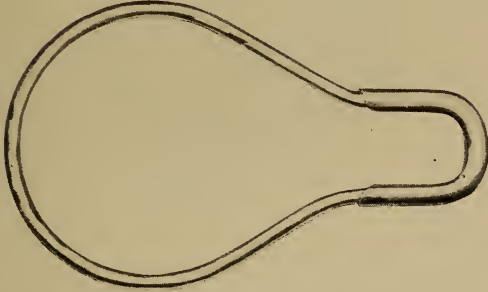

† 808-C.

1½x2½ inches.

Code.....	Persimile
Each.....	\$0.08
Weight per dozen, lbs.....	¾
One hundred in a box.	

SHOWER BATH CURTAINS.

RUBBER OR DUCK.

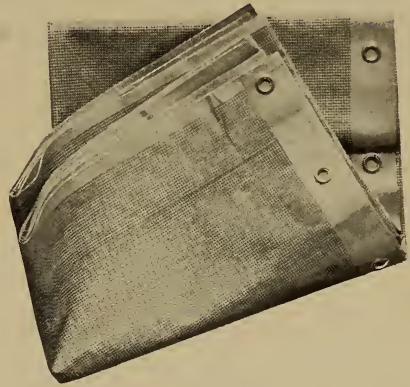

† 809-C.

3 x 7 feet.

Code.....	Persiste	Persiston	Persitare
	Windsor Check	Drab	White Duck
Per pair.....	\$8.00	8.00
Wgt. per pair, lbs....	3½	3½	3
Half pair in a box.			

CURTAIN RODS WITH FLANGES AND RINGS.

BRASS NICKEL-PLATED.



† 810-C.

Code.....	Persolana	Persolve	Personaba	Personage
Length, feet.....	3	4	5	6
Each.....	\$4.50	6.00	7.50	9.00

We can furnish above any desired size or length to order.

BATHING CAPS.

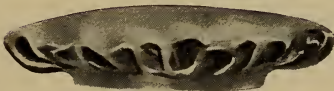

† 811-C.

Code.....	Personize	Personne
	Cloth, Rubber Lined	Pure Rubber
Each.....	\$0.30	.50

Twelve in a box.

† Carried in San Francisco only.

CURTAIN RINGS.

BRASS NICKEL-PLATED.



† 812-C.

With Snaps and Wall Flange.
Diameter, 24 inches.

Code.....	Personne
Each.....	\$8.50

In Orders and Specifications give Plate Numbers.

SOAP DISHES.

FOR WASH STANDS.

EXTRA HEAVY BRASS NICKEL-PLATED



† 820-C.
4¾ x 3¾ inches.

Code.....	Perspectif
Each.....	\$0.65
Weight per dozen, pounds	3½



821-C.
4¾ x 3¾ inches.

Code.....	Perspirate
Each.....	\$0.65
Weight per dozen, pounds.....	4
One-half dozen in a box.	



† 822-C.
5x4 inches.

Code.....	Persplank
Each.....	\$0.85
Weight per dozen, pounds.....	6¼
One-quarter dozen in a box.	



823-C.
5x4 inches.

Code.....	Perspomp
Each	\$1.10
Weight per dozen, pounds.. ..	7

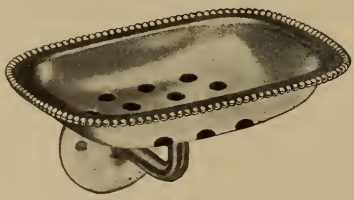

† 824-C.
5x4 inches.

Code.....	Perstabis
Each.....	\$1.00
Weight per dozen, pounds.....	6¾
One-sixth dozen in a box.	



825-C.
5x4 inches.

Code	Pertectum
Each	\$1.10
Weight per dozen, pounds.....	8¼
One-sixth dozen in a box.	

Screws packed with all fixtures which require them.

† Carried in San Francisco only.

In Orders and Specifications give Plate Numbers.

SOAP DISHES.

FOR THE WALL.

EXTRA HEAVY BRASS NICKEL-PLATED.



† 826-C.

5x4 inches.

Code.....	Pertendero
Each.....	\$1.40
Weight per dozen, lbs.....	9¾
One-sixth dozen in box.	

SOAP DISH COVERS.



827-C.

For Soap Dishes. 822-C, 823-C, 825-C, 826-C.

Code.....	Pertentas
Each.....	\$0.60
Weight per dozen, lbs.....	3¾
One-half dozen in a package.	



828-C.

5x4 inches.

Code.....	Perticando
Each.....	\$1.50
Weight per dozen, lbs.....	9¾
One-sixth dozen in box.	

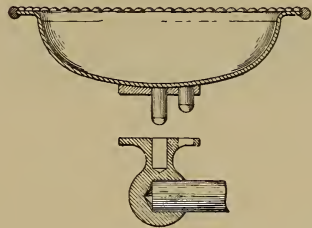

829-C.

Plate 829-C shows how Plate 828-C can be instantly removed from bracket to facilitate cleaning, but cannot be accidentally displaced.



† 830-C.

Dishes may be removed.

Code.....	Pertichi
Each.....	\$3.00
Weight each, lbs.....	1¼
One-quarter dozen in a box.	

Screws packed with all fixtures which require them.

† Carried in San Francisco only.

In Orders and Specifications give Plate Numbers.

SOAP DISHES.

BRASS NICKEL-PLATED.

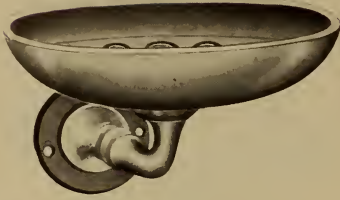

† 835-C.

Cast Brass Nickel-Plated. 4¼x3 inches.

Code	Perstaret
Each.....	\$1.50
Weight per dozen, lbs.....	9
Two in a box.	



† 836-C.

With China Tray.

Code.....	Persternes
Each.....	\$2.00
Weight per dozen, lbs.....



† 837-C.

Cast Brass Nickel-Plated.

Code	Perstringe
Size, inches	4¼x3
Each.....	\$0.90
Weight per dozen, lbs.....	6

Six in a box.



838-C.

Soap Dish and Chain Stay, with Threaded Rod and Nuts to fasten to Marble Slab.

Code.....	Perstructo
Size, inches	4¼x3¾
Each.....	\$1.40
Weight per dozen, lbs.....	8¾



† 839-C.

Stamped Brass. 4½x3 inches.

Code.....	Perstabile
Each.....	\$0.25
Weight per dozen, lbs	3¼

Twelve in a box.

Screws included with all fixtures.

† Carried in San Francisco only.



† 840-C.

Stamped Brass. 4½x4 inches.

Code	Perstitem
Each	\$0.30
Weight per dozen, lbs.....	3¼

In Orders and Specifications give Plate Numbers.

SOAP DISHES.

EXTRA HEAVY BRASS NICKEL-PLATED.

Flexible Loop Hangers adjustable to any size Roll Rim Bath Tub.

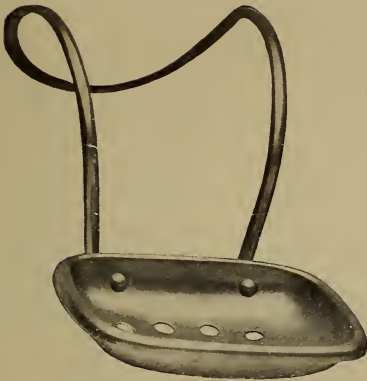

841-C.

4¾ x 3½ inches.

Code.....	Persway
Each.....	\$0.65
Weight per dozen, lbs.....	5½
Twelve in a box.	



842-C.

5¼ x 4 inches.

Code.....	Pertained
Each.....	\$1.00
Weight per dozen, lbs.....	9¼
Six in a box.	



† **843-C.**

Cast Brass Nickel-Plated. 5¼ x 3½ inches.

Code.....	Pertinaz
Straps, inches.....	8½
Fits roll rims up to, inches.....	3½
Each.....	\$1.60
Weight per dozen, lbs.....	10
Six in a box.	

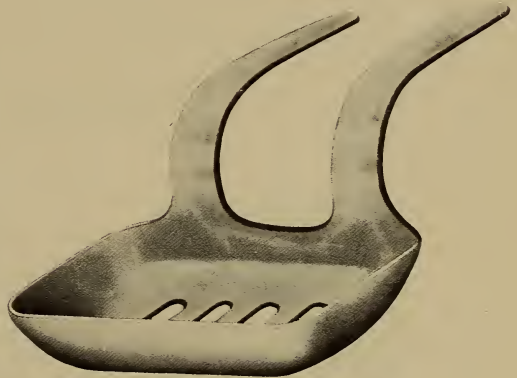

† **844-C.**

Cast Brass Nickel-Plated. 5 x 3¼ inches.

Code.....	Pertness
Straps, inches.....	4
Fits roll rims up to, inches.....	2½
Each.....	\$1.10
Weight per dozen, lbs.....	7½
Two in a box.	

† Carried in San Francisco only.

In Orders and Specifications give Plate Numbers.

SOAP AND TUMBLER HOLDERS.

CAST BRASS NICKEL-PLATED.



† 845-C.

For Corner Lavatory. Height, 6 inches.

Code.....	Pertolero
Each.....	\$2.00
Weight each, lbs.....	1¾

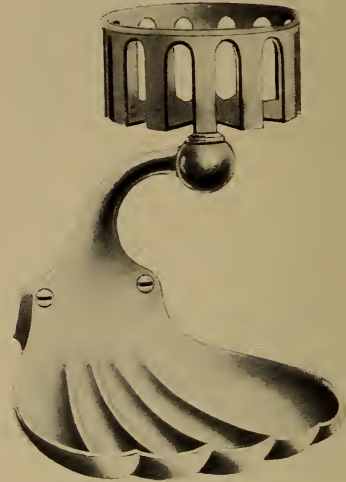

† 846-C.

For Flat Back Lavatory. Height, 6 inches.

Code.....	Pertracta
Each.....	\$2.00
Weight each, lbs.....	1¾

One in a box.

TUMBLER HOLDERS.

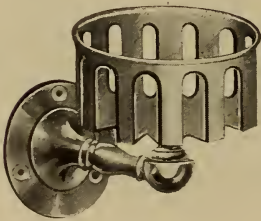

† 850-C.

Cast Brass Nickel-Plated.
Diameter, 3 inches.

Code.....	Pertreche
Each.....	\$1.20
Weight each, lbs.....	¾

One in a box.

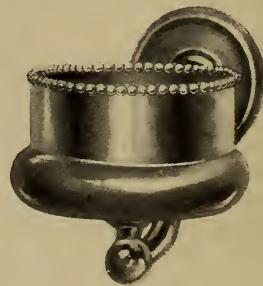

851-C.

Seamless, with Perforated Bottom.
Diameter, 3 inches.

Code.....	Pertrepido
Each.....	\$1.00
Weight per dozen, lbs.....	7

Six in a box.

Screws included with all fixtures.

† Carried in San Francisco only.

In Orders and Specifications give Plate Numbers.

TOOTH BRUSH AND TUMBLER HOLDERS.

ALL BRASS NICKEL-PLATED.



853-C.

With removable Soap Dish. See 829-C.

Extreme height, 10¼ inches; extreme width, 8½ inches; Soap Dish, 5x4 inches.

Code.....	Pertudero
Each.....	\$4.50
Weight each, pounds.....	3½

One in a box.



854-C.

Screws included with all fixtures.

Code	Pertugio
Each.....	\$2.75
Weight each, pounds.....	2¾

One in a box.

In Orders and Specifications give Plate Numbers.

TOOTH BRUSH AND TUMBLER HOLDERS.

BRASS NICKEL-PLATED.



† 856-C.

Extreme height, 11 1/2 inches; extreme width, 8 1/2 inches.

Code	Pertunda
Each	\$5.25
Weight each, pounds	3

One in a box.

Soap Dish is removable (see plate 829-C, page 222.)

The Fingers on the left hand Bracket are adjustable to hold any package of standard make of dentifrice.

Screws included with all fixtures which require them.

† Carried in San Francisco only.

In Orders and Specifications give Plate Numbers.

TOOTH BRUSH AND TUMBLER HOLDERS.

BRASS, NICKEL-PLATED.



†857-C.

Extreme height, 7½ inches; extreme width, 3½ inches.

Code	Pertubast
Each.....	\$1.50
Weight each, lbs.....	1 ¾

One in a box.

Screws included with all fixtures.

TOOTH BRUSH HOLDERS.

ALL BRASS NICKEL-PLATED.

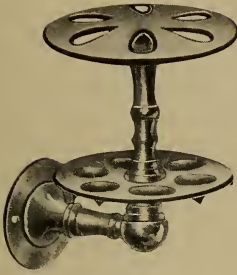

† 860-C.

Cast Brass Nickel-Plated.

Code Perturbar
 Each \$1.20
 Weight each, lbs ¾
 One in a box.

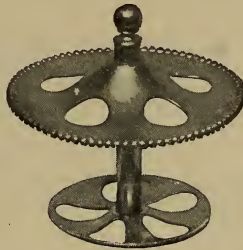

861-C.

Code Perturpis
 Each..... \$0.60
 Weight per doz., lbs.... 2¾
 Twelve in a box.



862-C.

Code Pertused
 Each..... \$0.75
 Weight per doz., lbs.... 12
 One in a package.



865-C.

With removable Soap Dish (see 829-C.); extreme height, 11 inches; extreme width, 5 inches.

Code Perubique
 Each \$3.00
 Weight each, lbs 2¼
 One in a box.



866-C.

All Tumbler Holders are Seamless and have Perforated Bottoms.

Code..... Perulaire
 Each..... \$1.25
 Weight per dozen, lbs..... 19½
 One in a box.

Screws included with all fixtures.

† Carried in San Francisco only.

In Orders and Specifications give Plate Numbers.

SPONGE OR BATH BRUSH HOLDERS.

BRASS NICKEL-PLATED.



† 868-C.

Wall Sponge Holder, 5¼x6¾x3 inches.

Code.....	Perunges
Each.....	\$1.50
Weight per dozen, pounds.....	12¾

Two in a box.



† 869-C.

Tub Sponge or Brush Holder, 5¼x6¾x3 inches.

Code.....	Perurbane
Each.....	\$1.50
Weight per dozen, pounds.....	15⅝

Six in a box.

Screws included with all fixtures which require them.

† Carried in San Francisco only.

In Orders and Specifications give Plate Numbers.

SOAP AND SPONGE HOLDERS.

BRASS NICKEL-PLATED.



† 870-C.

Sponge Holder, $5\frac{3}{4} \times 6\frac{3}{4} \times 3$ inches. Soap Holder, 5×4 inches.

Code.....	Perurinde
Each.....	\$2.50
Weight per dozen, lbs.....	21 $\frac{3}{4}$
One in a box.	

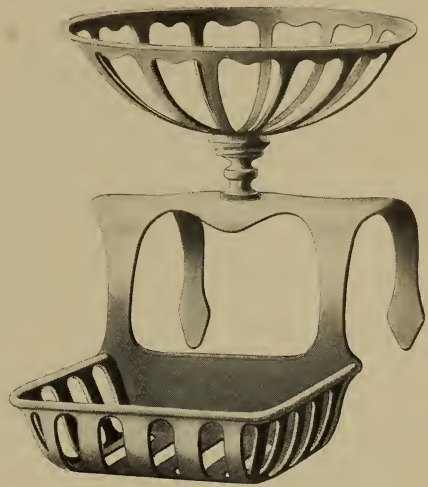

† 871-C.

Cast Brass Nickel-Plated.

Sponge Holder, $6\frac{1}{2} \times 5\frac{1}{2}$. Soap Holder, $5\frac{1}{4} \times 3\frac{1}{2}$. Length of Straps, $8\frac{1}{2}$ inches.

Code.....	Perusin
Each.....	\$3.20
Weight per dozen, lbs.....	19 $\frac{1}{2}$
One in a box.	

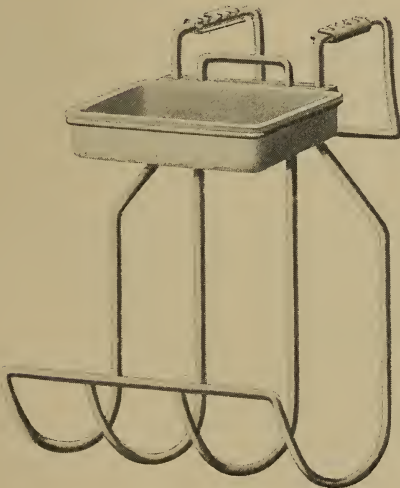

† 872-C.

With White Porcelain Soap Cup, $4\frac{3}{4} \times 3\frac{3}{4}$ inches. Adjustable Hook for Rims from $2\frac{1}{2}$ to $3\frac{3}{4}$ inches wide. Extreme width, 7 inches. Extreme height, 8 inches.

Code.....	Perussit
Each.....	\$2.15
Weight per dozen, lbs.....	13 $\frac{1}{2}$
Loose.	

† Carried in San Francisco only.

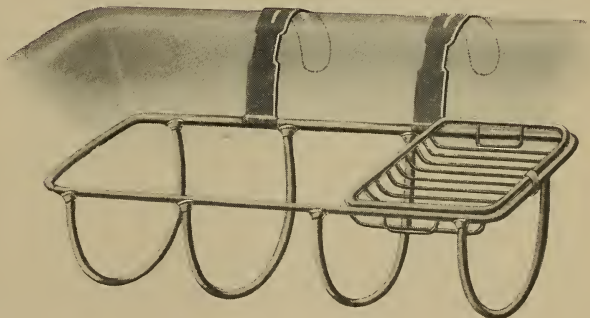

† 873-C.

With Detachable Soap Cup, which can be placed at either end of Holder, thereby making them either right or left. Soap Holder, $4\frac{1}{2} \times 3\frac{1}{4}$ inches. Sponge Holder, $7 \times 4\frac{1}{2}$ inches.

Code.....	Perustum
Each.....	\$2.00
Weight per dozen, lbs.....	11
Six in a box.	

In Orders and Specifications give Plate Numbers.

SPONGE OR BATH BRUSH HOLDERS.

BRASS NICKEL-PLATED.

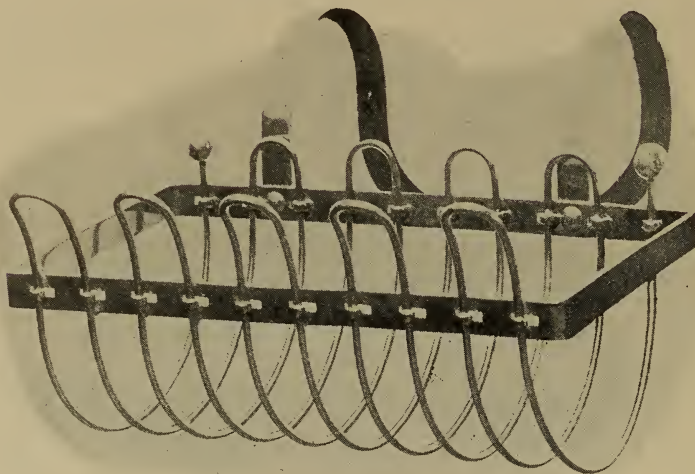

† 875-C.

Adjustable to any Roll Rim Bath Tub.

Code.....	Perutile
Each.....	\$1.25
Weight per dozen, lbs.....	14¾

Six in a box.

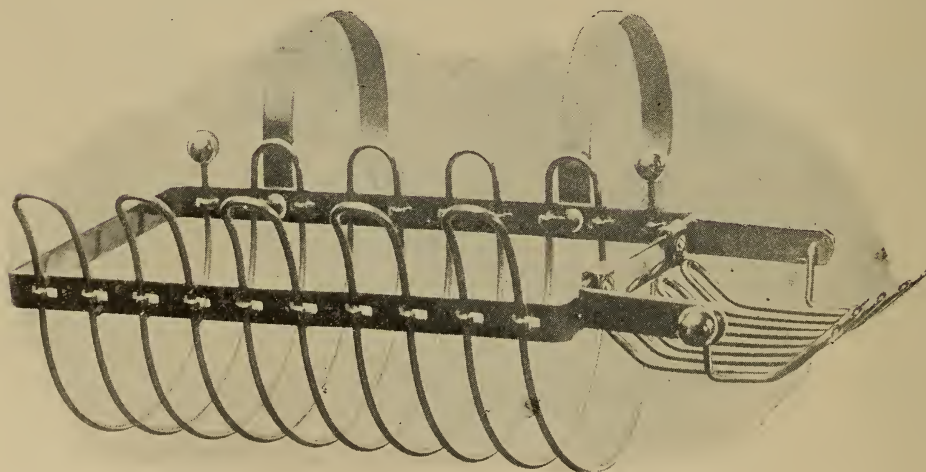

† 876-C.

Combination Sponge and Soap Holder. Soap Holder removable and may be attached to either end.

Code.....	Peruvian
Each.....	\$1.75
Weight per dozen, lbs.....	15½

Six in a package.

† Carried in San Francisco only.

In Orders and Specifications give Plate Numbers.

SPONGE HOLDERS.



† 877-C.

CAST BRASS NICKEL-PLATED.

Oval, with Bent Tube Bracket.
5½ inches by 6½ inches.

Code	Pervade
Each.....	\$1.60
Weight each, lbs.....	1

One in a box.

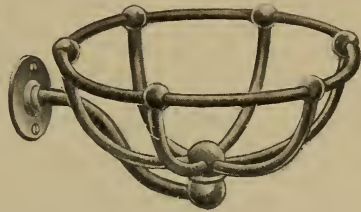

† 878-C.

NICKEL-PLATED.

Round; diameter, 7 inches.

Code.....	Pervagor
Each.....	\$1.60
Weight each, lbs.....	1

One in a box.

TOOTH POWDER RECEPTACLE.

BRASS NICKEL-PLATED.

WHISK-BROOM HOLDER.

BRASS NICKEL-PLATED.



† 880-C.

Width, 4 inches.

Code.....	Pervalidi
Each.....	\$0.40
Weight per doz., lbs.....	2½

Six in a box.



† 882-C.

Extreme height, 6 inches; width, 2½ inches.

Code.....	Pervasion
Each.....	\$2.00
Weight per doz., lbs.....	9

Two in a box.

Screws included with all fixtures which require them.

† Carried in San Francisco only.

In Orders and Specifications give Plate Numbers.

COMB AND BRUSH HOLDERS.

ALL BRASS NICKEL-PLATED.



884-C.

Dimensions, 10½ x 4¼ x 2.

Code.....	Pervasto
Each.....	\$2.25
Weight per dozen, lbs.....	11½

Six in a box.



† 885-C.

CAST BRASS NICKEL-PLATED.

Dimensions, 9½ x 3¾ x 1¾ inches.

Code.....	Perveho
Each.....	\$2.20
Weight per dozen, lbs.....	13½

Two in box.



† 887-C.

ELK WASH CLOTH HOLDERS.

CAST BRASS NICKEL-PLATED.

Code.....	Pervelles
Each.....	\$2.00
Weight each, lb.....	1

One in a box.

Prongs are blunt and will in nowise injure cloth. Also a handsome Tooth Brush Holder.

Screws included with all fixtures.

† Carried in San Francisco only.

In Orders and Specifications give Plate Numbers.



† 888-C.

WALL TOWEL BASKETS.

BRASS. NICKEL-PLATED.

Sanitary, Handsome, Useful.

Height, 18 inches; width, 11½ inches; depth, 8 inches.

Code.....	Pervemade
Each.....	\$8.50
Weight each, lbs.....	5

One in a package.

† Carried in San Francisco only.

† 891-C.

1-inch Bar; 3-inch Flange.

Code.....	Pervestigo	Pervetus
Length, inches.....	12	18
Each.....	\$3.50	4.00
Weight each, lbs.....	2½	2¾

One in a package.

HAND RAIL AND TOWEL BAR.

BRASS NICKEL-PLATED. JOINTS BRAZED.

Bars Tested to 600 Pounds.



892-C.

Bar 1 inch diameter.

This bar placed above the bath tub will prevent many accidental falls, and will be a great aid to heavy, sick or aged. A superb fixture, and very desirable for bath towels.

Code	Pervolvo	Perzik	Pesadelo	Persadez
Length, inches.....	30	36	† 42	48
Each.....	\$3.50	4.00	4.50	5.00
Weight each, lbs.....	2½	2¾	3¼	3¾

Two in a box.

Screws included with all fixtures.

† Carried in San Francisco only.

In Orders and Specifications give Plate Numbers and Sizes.

TOWEL BARS.

BRASS NICKEL-PLATED.

Made of extra heavy brass tubing. Brackets cast brass, highly finished. Extends 3½ inches from wall.

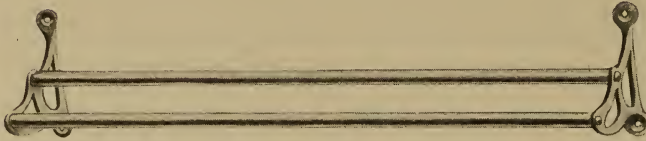

894-C.

Forty inches of towel space. Length, 20 inches.

Code.....	Pesanteur
Each.....	\$1.75
Weight per dozen, lbs.....	15½

Six in a package.

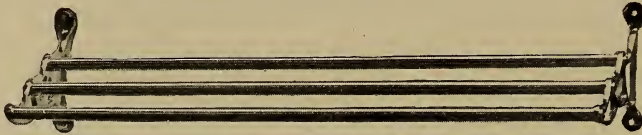

895-C.

Sixty inches of towel space, Length, 20 inches.

Code.....	Pesavano
Each.....	\$2.50
Weight per dozen, lbs.....	20

Six in a package.

ROLL TOWEL BARS.

BRASS NICKEL-PLATED.

The roll is made of heavy brass tubing, 1 inch in diameter, the flanges are brazed on, and the pintles riveted into the flanges. The wall brackets are strong and simple, with 1-inch ball ends.



897-C.

For roller towels. Length, 20 inches.

Code.....	Pescaban
Each.....	\$1.50
Weight per dozen, lbs.....	16½

Six in a package.

Screws included with all fixtures.

† Carried in San Francisco only.

In Orders and Specifications give Plate Numbers.

TOWEL BARS.

BRASS NICKEL-PLATED.

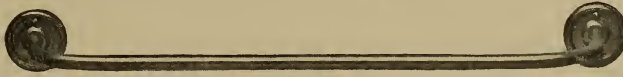

900-C.

Diameter of bar, 1/2 inch.

Code.....	Pescados	Pescantes	Pescario	Pescatore	Pescetto	Pescheria
Length, inches.....	† 12	† 14	† 16	18	24	30
Each.....	\$0.50	.55	.60	.65	.85	1.00
Weight per dozen, lbs.....	3 7/8	4 1/8	4 1/2	4 5/8	7	8

Six in a box.

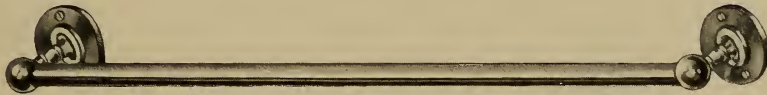

901-C.

Diameter of bar, 1/2 inch.

Code.....	Pescocudo	Pescozon	Pescuno	Pesebron
Length, inches.....	20	24	30	† 36
Each.....	\$1.10	1.20	1.35	1.50
Weight per dozen, lbs.....	12 1/2	14	16	21

Six in a box.



† **902-C.**

Diameter of bar, 3/4 inch.

Code.....	Pesepelle	Pesereste
Length, inches.....	30	36
Each.....	\$2.00	2.25
Weight each, lbs.....	2	3

Six in a package.

Screws included with all fixtures.

† Carried in San Francisco only.

In Orders and Specifications give Plate Numbers and Sizes.

TOWEL SHELVES.

BRASS NICKEL-PLATED.

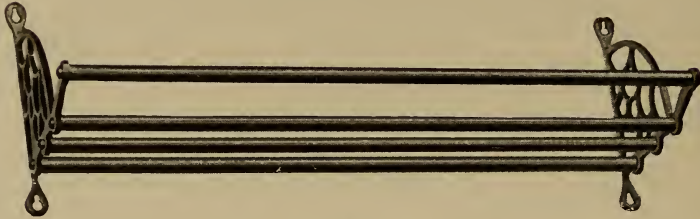

904-C.

Length, 20 inches.

Code	Pesours
Each.....	\$3.50
Weight each, pounds.....	3½

Two in a package.

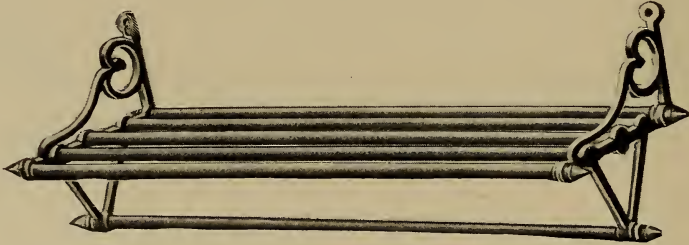

†905-C.

With Towel Bar.

Length, 20 inches ; width, 6½ inches.

Code	Pesiamo
Each.....	\$3.60
Weight each, pounds.....	2

One in a package.



†906-C.

Length, 20 inches ; width, 6½ inches.

Code.....	Pesillite
Each.....	\$3.00
Weight each, pounds.....	2¼

One in a package.

Screws included with every fixture.

† Carried in San Francisco only.

In Orders and Specifications give Plate Numbers.

UNIVERSAL SWING TOWEL BARS.

POLISHED STEEL. HANDSOMELY NICKEL-PLATED. 3-16 INCH ROD.

One Arm.

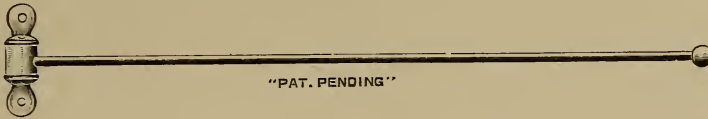

907C.

Code.....	Pesilean
Number.....	2 A
Length of arm, inches.....	12
Per dozen.....	\$0.75
Weight per dozen, lbs.....

Two Arms.

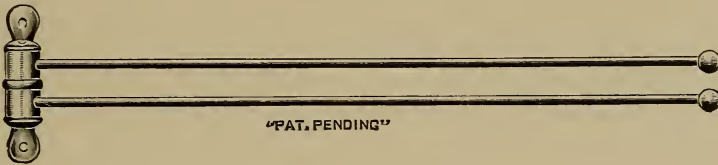

908C.

Code.....	Pesilene
Number.....	2 A
Length of arm, inches.....	12
Per dozen.....	\$1.25
Weight per dozen, lbs.....

Three Arms.

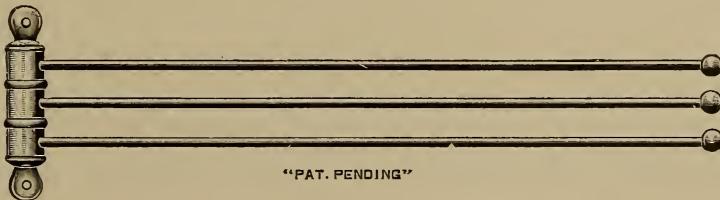

909C.

Code.....	Pesilette
Number.....	3 A
Length of arms, inches.....	12
Per dozen.....	\$1.75
Weight per dozen, lbs.....

All of above, one dozen in a box.

In Orders and Specifications Give Plate Numbers and Sizes.

SWING ARM TOWEL BARS.

BRASS NICKEL-PLATED.



† 910-C.

Arms. $\frac{3}{8}$ x15 inches.

Code.....	Pesolone	Pespunta
Numbers.....	305-2	305-3
Arms.....	2	3
Each.....	\$1.00	1.20
Weight per dozen, lbs.....	7½	10

Twelve in a box.

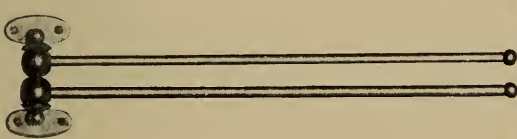

911-C.

2 arms.

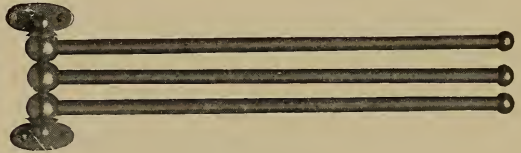

† 912-C.

3 arms.

BRASS NICKEL-PLATED.

Made of Extra Heavy half-inch Tube fourteen inches long. Ball ends. The Pivot upon which the Bars swing is a Heavy Steel Rod firmly secured to the Brackets. It is fastened to the wall by four screws. Strong, Sanitary and Symetrical.

Code.....	Pesquis	Pesquiza
Numbers.....	22	23
Arms.....	2	3
Each.....	\$1.00	1.25
Weight per dozen, lbs.....	13½	18¼

Six in a box.

OPAL GLASS TOWEL BARS.



916-C.

1-INCH OPAL GLASS BAR.

This fixture is a solid Bar of tough polished white Opaque Glass, each end being accurately fitted to a Heavy Cast Bracket, Nickel-Plated. It is Elegant and Substantial, and the use of Glass is in line with the most approved sanitary practice.

Code.....	Pessimes	Pessula	Pessute
Length, inches.....	18	24	‡ 30
Each.....	\$2.50	3.00	4.00
Weight each, lbs.....	2¼	3	3¾

One in a box.

Screws included with all fixtures.

† Carried in San Francisco only. ‡ Carried in Los Angeles only.

In Orders and Specifications give Plate Numbers and Sizes.

PLATE GLASS LAVATORY FIXTURES.

WITH NICKEL-PLATED BRONZE BRACKETS AND SCREWS. NO HOLES IN GLASS. ALL EDGES ARE GROUND AND POLISHED.

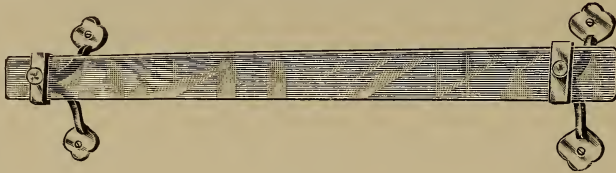

918-C.

ADJUSTABLE PLATE GLASS TOWEL BARS.

Code.....	Pestaneo	Pestard	Pestartil
Numbers.....	0	1-24	‡ 1-30
Length, inches.....	12	24	30
Each.....	\$3.00	4.00	5.00
Weight each, lbs.....	3½	7	8½

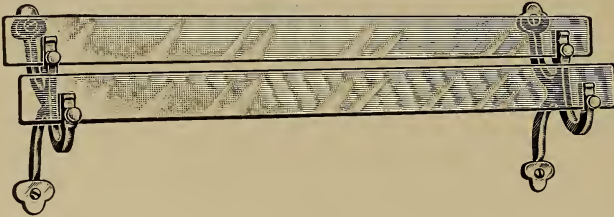

919-C.

EXTRA HEAVY ADJUSTABLE PLATE GLASS TOWEL BARS.

Code.....	Pestartilg
Number.....	12
Length, inches.....	24
Each.....	\$12.00
Weight each, lbs.....	13



920-C.

ROUND GLASS TOWEL BARS.

¾-inch solid round glass polished.

Code.....	Pestbuil
Number.....	3
Length, inches.....	24
Each.....	\$5.00
Weight each, lbs.....	5

For cutting plate 920-C shorter than above, add \$0.50 each.

‡ Carried in Los Angeles only.

In Orders and Specifications give Plate Numbers and Stock Numbers.

PLATE GLASS LAVATORY FIXTURES.

WITH NICKEL-PLATED BRONZE BRACKETS AND SCREWS. NO HOLES IN GLASS. ALL EDGES ARE GROUND AND POLISHED.

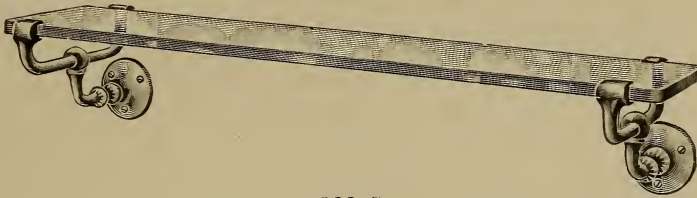

922-C.

ADJUSTABLE PLATE GLASS TOWEL SHELF.

5 inches wide, 24 inches long.

Code.....	Pestdamp
Number.....	4
Each	\$7.50
Weight each, pounds.....	11½

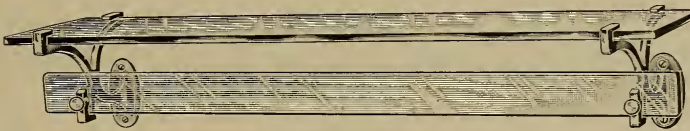

923-C.

ADJUSTABLE PLATE GLASS TOWEL SHELF AND BAR.

Shelf 6 inches wide, 24 inches long.

Code.....	Pestfleck
Number	6
Each	\$10.00
Weight each, pounds.....	13½

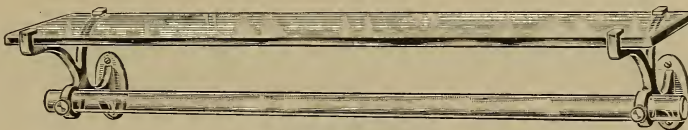

924-C.

ADJUSTABLE PLATE GLASS TOWEL SHELF AND ROD.

Shelf, 6 inches wide. Rod, ¾-inch diameter. Length, 24 inches.

Code	Pesthaft
Number.....	7
Each.....	\$12.00
Weight each, pounds.....	14

In Orders and Specifications give Plate Numbers and Stock Numbers.

OPAL GLASS SHELVES.

TRIMMINGS BRASS, NICKEL-PLATED.



† 926-C.

Opal Glass, $\frac{1}{16}$ -inch thick and 5 inches wide.

Code.....	Pestibile	Pestilent	Pestilium
Length, inches.....	20	24	30
Each.....	\$4.10	4.50	4.90
Weight each, pounds.....	$4\frac{7}{16}$	$5\frac{5}{16}$	$6\frac{3}{16}$

One in a box.

PLATE GLASS SHELF COMBINATIONS.

Trimnings Brass, Nickle-Plated. Plate Glass $\frac{3}{8}$ -inch thick. Length of Shelf, 24 inches; width of Shelf, 5 inches; diameter of bar, $\frac{1}{2}$ inch; length of bar, 18 inches.



† 928-C.

Code	Pestillos
Each.....	\$7.50
Weight each, pounds.....	9½

One in a box.

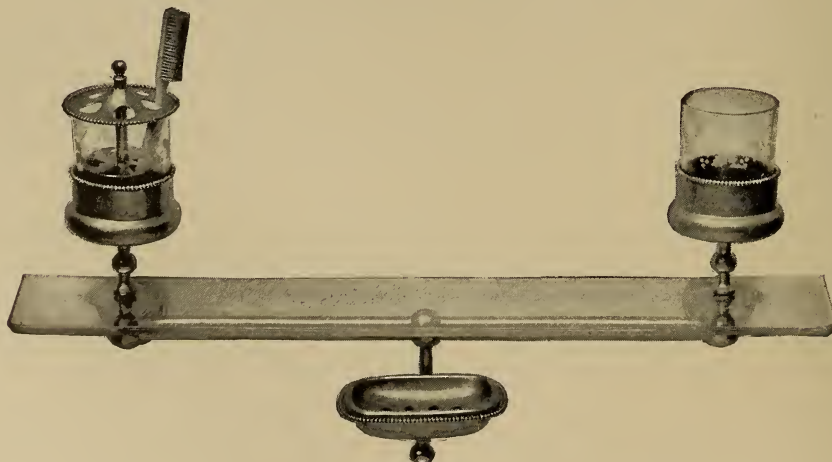

† 930-C.

Has removable Soap Dish. See plate 829-C, page 235.

Code.....	Pestluft
Each.....	\$9.00
Weight each, pounds.....	8½

One in a box.

Screws included with all Fixtures.

† Carried in San Francisco only.

In Orders and Specifications give Plate Numbers.

GUARD RAILS.

FOR ALL TYPES OF GLASS SHELVES. BRASS, NICKEL-PLATED.



†931-C.

Cut shows Rail in position on Shelf.

Code.....	Pestmask	Pestmelt	Pestmice
Fits shelves, inches	20x5	24x5	30x5
Each	\$1.50	1.75	2.00
Weight each, lbs.....	$\frac{5}{8}$	$\frac{3}{4}$	$\frac{7}{8}$

Screws included with all fixtures.

†Carried in San Francisco only.

HOOKS.

BRASS, NICKEL-PLATED.

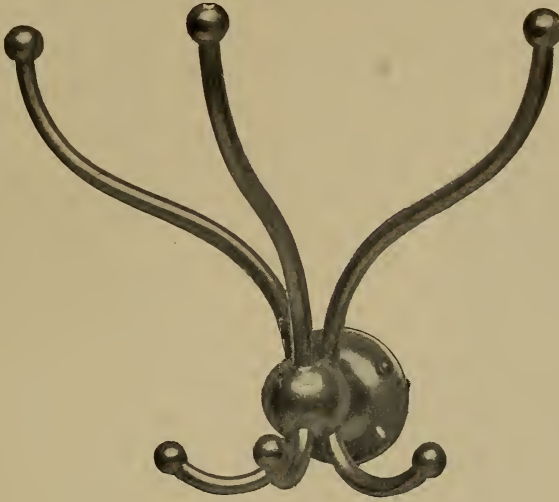

932-C.

Height, 9½ inches; width, 10½ inches.

Code	Pestono
Each.....	\$2.25
Weight per doz., lbs.....	16¾

Six in a box.



933-C.

Height, 6 inches.

Code.....	Peststoff
Each.....	\$0.50
Weight per doz., lbs....	3½

Twelve in a box.



† **934-C.**

Height, 3¾ inches.

Code.....	Pestzeit
Each.....	\$0.40
Weight per doz., lbs....	2⅝

Twelve in a box.



† **935-C.**

Height, 6 inches.

Code.....	Pesunbo
Each.....	\$0.65
Weight per doz., lbs...	6

Six in a box.



936-C.

Spray or Razor Strop Hook.

Code.....	Petale
Each.....	\$0.30
Weight per doz., lbs.	2

Twelve in a box.



937-C.

Projects, 2¾ inches.

Code.....	Petalin
Each.....	\$0.25
Weight per doz., lbs.	3⅞

Twelve in a box.



† **938-C.**

Projects, 2 inches.

Code.....	Petaloma	Petardant
	Polished Brass.	Nickel-Plated.
Each.....	\$0.20	.20
Weight per doz., lbs.	1¼	1¼

Six in a box.

Screws included with all fixtures.

† Carried in San Francisco only.

In Orders and Specifications give Plate Numbers.

TOILET PAPER BOXES.

BRASS NICKEL-PLATED, WITH AUTOMATIC FINGERS TO HOLD PAPER UPRIGHT.



† 940-C.

Box, 5½ inches wide, 7¼ inches high, 2¼ inches thick.

Code.....	Petasonem
Each.....	\$1.25
Weight per dozen, lbs.....	12



† 941-C.

Box, 7¼ inches wide, 5½ inches high, 2¼ inches thick.

Code.....	Petauris
Each.....	\$1.25
Weight per dozen, lbs.....	12

Two in a box.



942-C.

Box, 7¼ inches long, 3 inches high, 5½ inches wide.

Code.....	Petechial
Each.....	\$1.35
Weight per dozen, lbs.....	12



† 943-C.

EXTRA HEAVY.

Box, 7¼ inches wide, 5½ inches high, 2¼ inches thick.

Code.....	Petegift
Each.....	\$1.35
Weight per dozen, lbs.....	17

Two in box.

† Carried in San Francisco only.

In Orders and Specifications give Plate Numbers.

ROLL PAPER HOLDERS.

BRASS, NICKEL-PLATED.

Extra Heavy, Roll with Ball Finish; locks into Bracket, but may be instantly removed. Width of Roll, 5 inches.



†947-C.

Code	Peteman
Each.....	\$1.00
Weight per dozen, lbs.....	9

Six in a box.

Screws included with all Fixtures.

†Carried in San Francisco only.

ROLL PAPER HOLDERS.

BRASS NICKEL-PLATED.

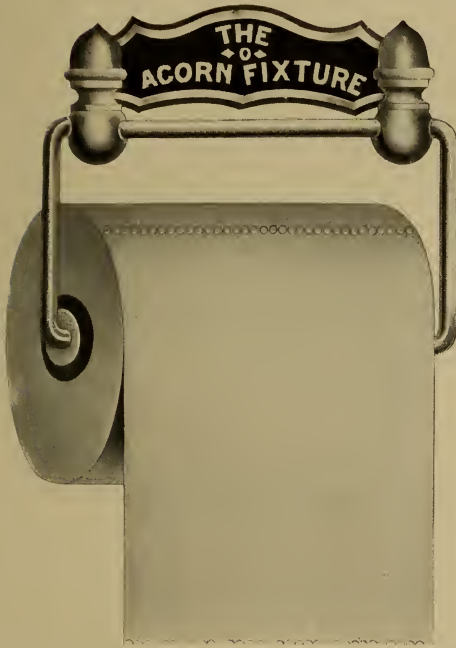

† 945-C.

Width of Roll, 5 inches.

Code.....	Petekind
Each.....	\$0.40
Weight per dozen, lbs.....	4¼

Twelve in a box.

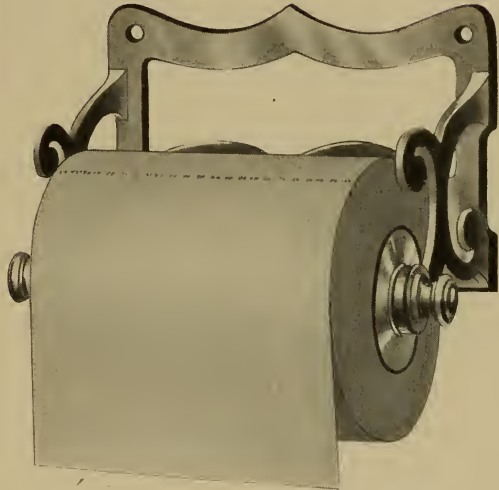

† 946-C.

Width of Roll, 5 inches; Frame, 6½ inches.

Code.....	Petelinos
Each.....	\$1.35
Weight per dozen, lbs.....	12

One in a box.



948-C.

Roll is Enameled, and Springs in.
Width of Roll, 5 inches.

Code.....	Petendum
Each.....	\$0.50
Weight per dozen, lbs.....	5¼

Six in a box.



949-C.

Extra Heavy Brass Roll and Flanges, all
Nickel-Plated. Width of Roll, 5 inches.

Code.....	Peterstag
Each.....	\$1.50
Weight per dozen, lbs.....	11¾

Three in a box.

Screws included with all Fixtures.

† Carried in San Francisco only.

In Orders and Specifications give Plate Numbers.

FRENCH PLATE GLASS MIRRORS.

NICKEL-PLATED BRASS FRAMES. BEVELED EDGES.



† 950-C.

Triple Adjustable Combination Mirror. On Hardwood Backs.

Diameter of Mirrors, 11 inches. Dimensions folded, 14x13½ inches.

Code	Petimen	Petinga	Petinine
Numbers	3 Oak	3 Maple	3 Mahogany
Each.....	\$18.50	18.50	18.50
Weight each, lbs.....	15	15	15

OVAL ADJUSTABLE MIRROR.



951-C.

NICKEL-PLATED BRASS SWINGING BRACKET AND FRAME.

Code.....	Petivit
Number	11
Mirror, inches.....	22x10½
Each	\$8.50
Weight each, lbs.....	8¼

ROUND ADJUSTABLE MIRROR.

NICKEL-PLATED SWING BRACKET.

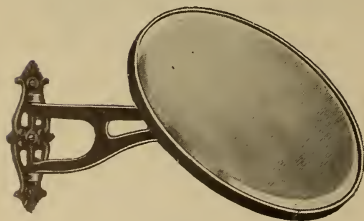

952-C.

Code.....	Petoffe
Number	9
Diameter of mirror, inches.....	11
Length of arm, inches.....	9
Each.....	\$4.50
Weight each, lbs.....	4¾

† Carried in San Francisco only.

In Orders and Specifications give Plate Numbers.

FRENCH PLATE GLASS MIRRORS.

EXTRA HEAVY SEAMLESS NICKEL-PLATED BRASS FRAMES WITH BEADED EDGES. METAL BACKS. INTERCHANGEABLE SCREW EYES, ALLOWING MIRROR TO BE HUNG VERTICALLY OR HORIZONTALLY.



953-C.

Round. 1¼-Inch Bevel.

Code.....	Petonce	Petong
Size, inches.....	24	† 30
Width of frame, inches.....	¾	⅞
Each.....	\$18.00	34.00
Weight each, lbs.....	24	36



† **954-C.**

Oblong. 1-Inch Bevel.

Code.....	Petoulier	Petryary
Size, inches.....	16x24	18x30
Width of frame, inches.....	⅞	⅞
Each.....	\$14.00	16.00
Weight each, lbs.....	19½	31½



955-C.

Oval. 1-Inch Bevel, ⅞-inch Frame.

Code.....	Petrejus	Petrifiant	Petrinos
Size, inches.....	13x20	16x24	† 21x30
Each.....	\$11.00	14.00	23.00
Weight each, lbs.....	19	21	25

† Carried in San Francisco only.

In Orders and Specifications give Plate Numbers and Sizes.

ADJUSTABLE OVAL MIRRORS.

EXTRA HEAVY, SEAMLESS, NICKEL-PLATED BRASS FRAMES, WITH BEADED EDGES.

METAL BACKS. BALL AND SOCKET JOINT.



956-C.

Sectional View.

Oval—1 inch Bevel, 7/8 inch Frame. Back, Braces and Wall Brackets Nickel-Plated.

Code	Petrisses	Petrobis
Size, inches.....	13x20	16x24
Each.....	\$19.00	22.00
Weight each, pounds.....	28	30

One in a Box.

These Mirrors are secured to a Wall Bracket extending six inches from wall, with Universal Ball and Socket Joint, which allows the Mirror to be turned to any desired position or angle, and there maintains it by friction only.

Very desirable for bath room, dressing room or boudoir.

Screws packed with all fixtures which require them.

In Orders and Specifications give Plate Numbers.

MATCH SCRATCHES AND HOLDERS.

CAST BRASS NICKEL-PLATED.

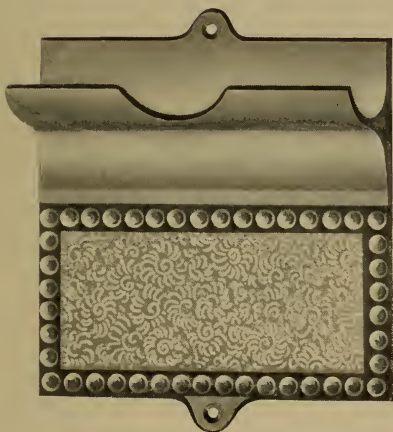

† 959-C.

Cigar Rest and Match Scratch.
4x4 inches.

Code.....	Petrogale
Each	\$0.40
Weight per dozen, lbs	5

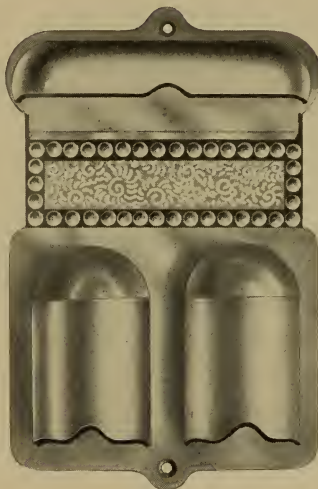

† 960-C.

Match Holder and Scratch.
3¼ x 5¼ inches.

Code.....	Petrolait
Each.....	\$1.75
Weight per dozen, lbs	7

Four in a box.

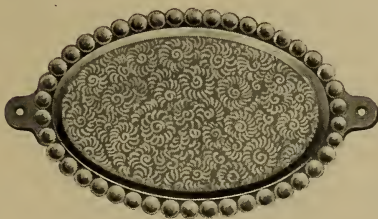

† 961-C.

Match Scratch. 4x2¼ inches.

Code.....	Petromele
Each.....	\$0.25
Weight per dozen, lbs	1½



† 962-C.

Cigar Rest. Width, 3⅞ inches.

Code..	Petrosal
Each	\$0.35
Weight per dozen, lbs.....	2½

Six in a box.

Screws included with all fixtures.

† Carried in San Francisco only.

In Orders and Specifications give Plate Numbers.

VITREOUS CHINA BATH ROOM FITTINGS.



† 970-C.

Soap Holder.

Length, 7½ inches; height, 6½ inches.

Code.....	Petruccio
Each.....	\$1.90
Weight each, lbs.....



† 971-C.

Sponge Holder.

Length, 8¼ inches; height, 7 inches.

Code.....	Petschaft
Each.....	\$2.50
Weight each, lbs.....



† 972-C.

Toilet Paper Holder.

Length, 6½ inches; height, 8½ inches.

Code.....	Pettifog
Each.....	\$1.90
Weight each, lbs.....

† Carried in San Francisco only.



† 973-C.

Whisk-Broom Holder.

Width, 6½ inches; height, 10 inches.

Code.....	Pettishly
Each.....	\$1.90
Weight each, lbs.....

In Orders and Specifications give Plate Numbers.

VITREOUS CHINA BATH ROOM FITTINGS.



† 974-C.

Brush and Comb Holders.

Length, 12 inches; height, 6½ inches.

Code.....	Pettorale
Each.....	\$3.75
Weight each, lbs.....



† 975-C.

Match Holders.

Width, 3¼ inches; height, 4 inches.

Code.....	Petulance
Each.....	\$1.00
Weight each, lbs.....



† 976-C.

Croton Sets for Lavatories.

Mouth Ewer, Shaving Mug, Covered Soap Dish, Tooth Brush Vase.

Code.....	Petulanza
Per set.....	\$3.00
Weight per set, lbs.....

† Carried in San Francisco only.

In Orders and Specifications give Plate Numbers.

BATH TUB SEATS.

NICKEL-PLATED TRIMMINGS. RUBBER SHEATHED SUPPORTS.

Finished with Two Coats of Finest Spar Varnish.



† 978-C.

Adjustable for 2½-inch to 3¾-inch rims.

Code	Petulum	Petunias
Number.....	400	400
Finish.....	Oak	White Enameled
Width, inches.....	6¼	6¼
Length of wood seat, inches.....	20	20
Each.....	\$1.60	2.25
Weight each, lbs.....	3¾	3¾

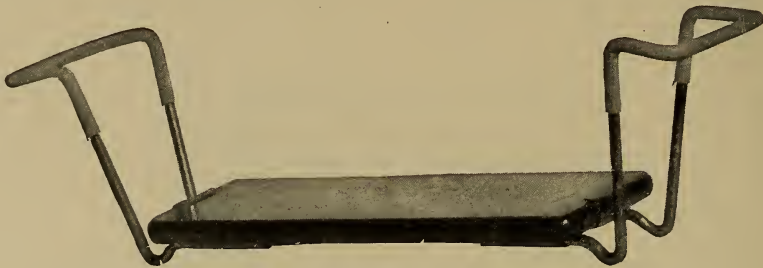

979-C.

Adjustable to all flat, round, or oval edge tubs.

Code	Peuldop	Peulvan
Number.....	200	260
Finish.....	Oak	White Enameled
Width, inches.....	6	6
Length of wood seat, inches.....	20	20
Each.....	\$1.50	1.90
Weight each, lbs.....	4¼/6	4¼/6



† 980-C.

† Carried in San Francisco only.

BATH STRAPS, HEAD RESTS OR SEATS.

NO. 16 GAUGE NICKEL-PLATED BRASS CLIPS. EXTRA HEAVY WEB STRAP.

Adjustable.

Code.....	Peuplade
Each	\$2.00
Weight each, lbs	2

Length of strap, 42 inches; width, 5 inches.

One in a package.

In Orders and Specifications give Plate Numbers.

“EMPIRE” BATH TUB SEATS.

FOR ROLL RIM TUBS.

SOLID POLISHED OAK. NICKEL-PLATED ADJUSTABLE BRACKETS.



981-C.

This seat is of solid highly polished oak. The brackets are nickel-plated and highly polished; the brackets slide in grooves on the under side of seat, and are held in position by thumb screws; the upper ends curve over and are securely riveted to suitable shaped oval pieces which are nickel-plated; the under side of the oval pieces or rests are entirely covered with sheet rubber, thus preventing the least scratching or marring of the finest tub.

Code	Peuplett
Width, inches.....	5½
Length, inches.....	19½
Each.....	\$2.50
Weight each, lbs	4¾

In Orders and Specifications give Plate Numbers.

CORK BATH MATS.

FOR THE BATH ROOM FLOOR.



† 982-C.

Cork, as is well known, is a perfect non-absorbent, and for that reason is always dry and warm, with a texture that gives a velvet-like surface agreeable and satisfying to the touch. Made of Refined Shaved Cork, under hydraulic pressure. Soft and smooth, yet firm. Indestructable. No amount of water or soap will injure them in any way.

Code.....	Peupliers
Size, inches.....	32 x 18
Each	\$5.00
Weight each, pounds..	6¼

One in a box.

CORRUGATED RUBBER BATH TUB MATS.

FOR THE BOTTOM OF BATH TUBS.

Made of best quality corrugated rubber, ⅛-inch thick, protected by cloth on the under side, which gives it strength and durability. Its wearing qualities are such that under ordinary circumstances, it is almost indestructable.

Being made of soft rubber it is flexible and conforms to the shape of the bottom of the bath tub and prevents accidents by slipping etc.

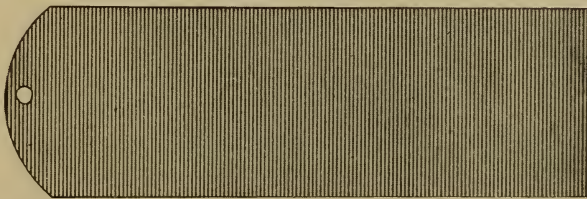

† 983-C.

Code.....	Pezuna	Pezuola
Size, inches.....	12 x 30	12 x 36
Each.....	\$2.10	2.40
Weight each, pounds.....	31	36

One-half dozen in a package.

† Carried in San Francisco only.

In Orders and Specifications give Plate Numbers and Sizes.

KNICKERBOCKER FOUNTAIN BRUSHES.

PURE INDIA RUBBER, WITH NICKEL-PLATED EXTENSION HANDLE.

Flexible. Sanitary. Self-Cleansing. Durable. Indispensable.

Each little rubber tooth is hollow and when the water is turned on many hundreds of little streams are flowing at the same time. Superior to sponges, cloths, bristle brushes, etc., in that it never gets dry, will not tear, does not irritate the skin and is always sweet, clean and sanitary. May be attached to any bath cock and a uniform temperature may be maintained.

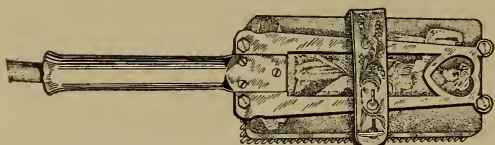

† 986-C.

Code.....	Pezzupal
Each.....	\$5.00
Weight, each, lbs.....

One in a box.

FOR THE
BATH, SHOWER, SHAMPOOING,
MASSAGE.

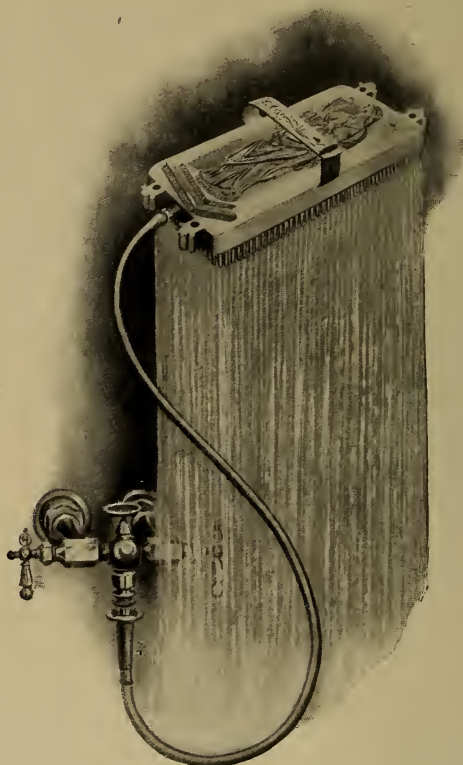

Connected to a hot and cold water faucet ready for use.

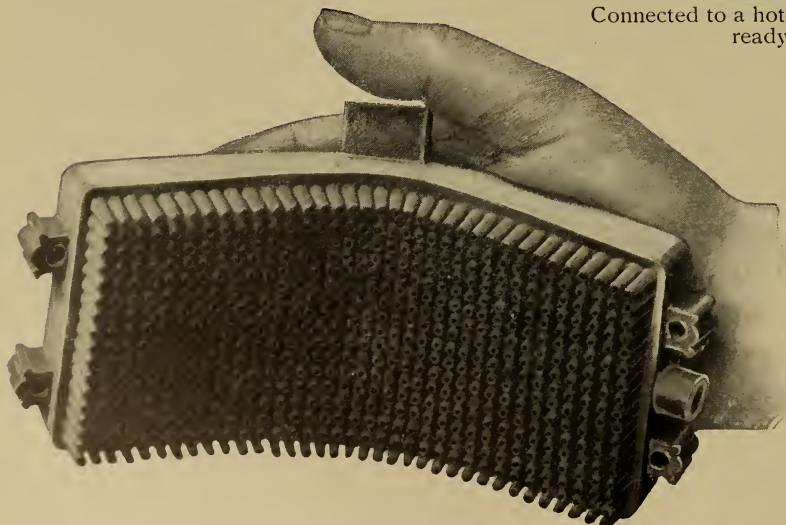

This illustration shows the flexibility of the Knickerbocker Fountain Brush.
† Carried in San Francisco only.

In Orders and Specifications give Plate Numbers.

SECTION 4.

SOLID PORCELAIN LAVATORIES.

ITALIAN MARBLE LAVATORIES.

TENNESSEE MARBLE LAVATORIES.

PORCELAIN ENAMELED LAVATORIES
AND LAVATORY FIXTURES.



HOLBROOK, MERRILL & STETSON,

INCORPORATED.

SAN FRANCISCO, LOS ANGELES AND NEW YORK.

LAVATORIES AND LAVATORY FIXTURES.

Ideal Solid Porcelain Lavatories are the best that the potter's skill can produce. Of elegant design and finish, the very best quality as regards material and durable beyond comparison. Besides the styles in the following pages, we are in a position to quote on a great number of different designs.

Marble Lavatories—quality of marble and its finish should not be overlooked. All of our marble is **selected stock**, deeply **countersunk**, carefully **finished** and highly **polished**. All the Marble Parts and the Metal Supply and Waste Fittings are fitted and adjusted to each Lavatory before shipment, thus **avoiding loss of time** and trouble when setting in place.

Porcelain Enameled Lavatories have no cracks or crevices, they are all in one piece. Like Solid Porcelain and Marble, these Lavatories are hard, smooth and non-absorbent although lighter in weight. The designs are graceful and every fixture is finished in such a manner as only long experience and careful attention can accomplish. Every Lavatory is carefully examined by us before shipment.

Lavatory Fixtures are Brass Nickel-plated. Traps, Legs and Supply Pipes are **adjustable**. The Supply Pipes are made of best Annealed Brass Tubing, iron pipe size.

In ordering goods from this section by telegraph, it is only necessary to use the code word over or opposite the number or size of the article or fixture wanted, preceded by words from code in front of this book.

Example : Cubiment two Pfandherr.

Translation : Ship via Pacific Coast Steamship Company two "Ideal" Solid Porcelain Lavatories 1002C twenty-seven by thirty-seven inches complete as described.

“IDEAL” SOLID PORCELAIN OVAL LAVATORIES.

ON SOLID PORCELAIN SWELL PATTERN PEDESTALS



1000-C.

Oval Solid Porcelain Lavatory and Pedestal. Glazed Pure White; Nickel-Plated Standing Waste with China Index; Nickel-Plated Low Pattern Compression Basin Cocks with China Indexes; Nickel-Plated 1½-inch Elliptical Trap to Wall; Nickel-Plated Supply Pipes to Wall; Nickel-Plated Wall Stays.

Code.....	Pfadlos	Pfaelzer	Pfahl
Size, inches.....	22 x 27	24 x 33	27 x 37
Lavatory complete as described.....	\$63.00	65.00	74.00
Shipping weight, each, lbs.....	150	160	240
Code.....	Pfahlbau	Pfahldorf	Pfahlholz
Lavatory with Pedestal, Standing Waste and Wall Stays only.....	\$52.00	54.00	63.00

Lavatory Fittings.

Oval Bevel Edge Plate Glass Mirror with Nickel-Plated Frame, 955-C, 21 x 30.....	\$23.00
Nickel-Plated Comb and Brush Holder, 884-C.....	2.25
Opal Glass Towel Bar, 916-C, 24 inches long.....	3.00
Nickel-Plated Soap Dish with China Removable Tray, 836-C.....	2.00
Two Nickel-Plated Tumbler Holders, 851-C.....	1.00

In Orders and Specifications give Plate Numbers and Sizes.

“IDEAL” SOLID PORCELAIN OVAL LAVATORIES.



Holbrook Merrill & Stetson

1002-C.

Oval Solid Porcelain Lavatory. Glazed Pure White; Nickel-Plated Compression Combination Lavatory Supply and Waste with China Indexes, Hot and Cold and Waste; Nickel-Plated Brass Legs with Special Frame and Supports to Wall; Nickel-Plated Adjustable Bag Trap to Wall; Nickel-Plated Supply Pipes to Wall.

Code.....	Pfandgut	Pfandhaus	Pfandherr
Size, inches.....	22 x 27	24 x 33	27 x 37
Lavatory complete as described.....	\$80.00	86.00	92.00
Shipping weight, lbs.....	120	140	220
Code.....	Pfandklage	Pfandkont	Pfandsach
Lavatory with Supply and Waste and Legs and Frame only.....	\$73.00	79.00	85.00

Lavatory Fittings.

Oval Beveled Edge Plate Glass Mirror with Nickel-Plated Frame, 21 x 30 inches, 955-C..	\$23.00
Opal Glass Shelf, 24 inches long, 926-C.....	4.50
Nickel-Plated Soap Dish with Removable Tray, 823-C.....	1.10
Nickel-Plated Towel Bar, 20 inches long, 895-C.....	2.50
Nickel-Plated Tooth Brush Holder with Tumbler, 866-C.....	1.25

In Orders and Specifications give Plate Numbers and Sizes.

SOLID PORCELAIN SQUARE LAVATORY.

WITH BACK AND NICKEL-PLATED LEGS.

**1004-C.**

Square Solid Porcelain Lavatory and Back, Glazed Pure White; Nickel-Plated Low Pattern Compression Basin Cocks, with China Indexes Hot and Cold; Nickel-Plated Standing Waste with China Index; Nickel-Plated Brass Legs.

Code.....	Pfarrant	Pfarius	Pfarkind
Size, inches.....	22 x 24	21 x 26	22 x 30
Height of back, inches.....	12	12	15
Lavatory complete as described.....	\$43.00	45.00	49.00
Shipping weight, each, lbs.....	145	175	205

With Iron Legs Painted White Enamel, deduct \$4.50.

With Patent Overflow Bowl, Nickel-Plated Strainer and Waste Plug, deduct \$3.50.

Code.....	Pfauchen	Pfauen	Pfeffer
Lavatory with Back and Standing Waste only.....	\$30.00	32.00	36.00

Lavatory Fittings.

Oblong Bevel Edge Plate Glass Mirror with Nickel-Plated Frame, 16 x 24 inches, 954-C....	\$14.00
Nickel-Plated Comb and Brush Holder, 885-C.....	2.20
Nickel-Plated Soap and Tumbler Holder, 846-C.....	2.00
Nickel-Plated Tooth Brush Holder, 860-C.....	1.20
Nickel-Plated Towel Bar, 18 inches, 900-C.....	.65

In Orders and Specifications give Plate Numbers and Sizes.

SOLID PORCELAIN ROUND FRONT LAVATORY.

WITH SOLID BACK.



1006-C.

Round Front Solid Porcelain, one piece Lavatory and Solid Porcelain Leg, Glazed Pure White, with connection to wall; Nickel-Plated Compression Low Pattern Basin Cocks with China Indexes; Nickel-Plated Overflow Grate, and Waste Plug with Rubber Stopper.

Code.....	Pfeiler
Lavatory complete as described.....	\$43.00
Shipping weight, each, lbs.....	135

With Nickel-Plated Standing Waste, add \$3.50.

Code.....	Pfeilgift
Lavatory with Overflow Grate and Plug only.....	\$30.50

Dimensions:

Length at back, 24 inches; back to front, 23 inches; height of back at center, 8 inches.

Lavatory Fittings.

Oval Bevel Edge Plate Glass Mirror with Nickel-Plated Frame 16 x 24 inches, 955-C.....	\$14.00
Nickel-Plated Towel Bar, 30-inch, 902-C	2.00
Nickel-Plated Tooth Brush and Soap Holder, with Tumbler, 865-C.....	3.00
Nickel-Plated Tumbler Holder, 851-C.....	1.00

In Orders and Specifications give Plate Numbers.

SOLID PORCELAIN LAVATORY.

WITH SOLID BACK.

**1009-C.**

Corner Solid Porcelain, one piece Lavatory, Glazed Pure White. Nickel-Plated Compression Low Pattern Basin Cocks with China Indexes; Nickel-Plated Overflow Grate and Waste Plug, with Rubber Stopper; Nickel-Plated Brass Leg, with Connection to Wall.

Code.....	Pfeilhorn
Each complete as described.....	\$43.00
Shipping weight each, lbs.....	135

With Nickel-Plated Standing Waste, add \$3.50.

With Solid Porcelain Leg, add \$2.00.

With Iron Leg Painted White Enamel, deduct \$2.00.

Code.....	Pfeilspiel
Lavatory with Overflow Grate and Plug only.....	\$30.50

Dimensions :

Length at sides, 19½ inches; greatest depth, 28 inches; corner of walls to front, 25 inches,

Lavatory Fittings.

Round Bevel Edge Plate Glass Mirror, with Nickel-Plated Frame, 24-inch, 953-C.....	\$18.00
Nickel-Plated Soap and Tumbler Holder, 845-C.....	2.00
Nickel-Plated Towel Bar, 20-inch, 901-C.....	1.10
Nickel-Plated Comb and Brush Holder, 885-C.....	2.20

In Orders and Specifications give Plate Numbers.

OVAL MARBLE LAVATORY.



† 1010-C.

Oval Italian Marble Slab, 33x24 inches, 1½ inches thick, countersunk extra deep, with Shell Soap Cup and Roll Edge; 14x19 Straight Back D Bowl (Vitreous China); Nickel-Plated Compression Combination Lavatory Supply and Waste, with China Indexes on Valves and Waste; Nickel-Plated Supply Pipes to Wall, with Stop Valves; Nickel-Plated 1½-inch Centrifugal Adjustable P Trap; Adjustable Nickel-Plated Brass Offset Legs with Frame and Braces to Wall; Screws and Basin Clamps.

Code.....	Pfennig
Lavatory, complete as described.....	\$90.50
Weight each, lbs.....	197

Price for above Lavatory in Tennessee Marble same as for Italian.

Roughing-in Measurements :

Height, 30½ inches; distance from face of finished wall to center of supplies, 6 inches; from face of finished wall to center of waste, 12 inches; from floor to center of supplies in wall, 16½ inches; from floor to center of waste outlet in wall, 15½ inches; center to center of supplies, 12 inches supplies, ¾-inch iron pipe size.

† Carried in San Francisco only.

In Orders and Specifications give Plate Numbers.

MARBLE LAVATORY.

† 1012-C.

Italian Marble Countersunk Slab, 22x32 inches, 1½ inches thick, with Shell Soap Cup, Triple Bead Moulding, 16-inch Back and 5-inch Aprons; 14x19 Straight Back D Bowl (Vitreous China); Nickel-Plated Fuller Combination Lavatory Supply and Waste, with China Name Plates on Handles and top of Waste; Nickel-Plated Supply Pipes to the Wall with Stop Valves; Nickel-Plated 1½-inch Bag Trap; Nickel-Plated Cast Brass Offset Lavatory Legs and Nickel-Plated Apron Supports; Screws and Basin Clamps.

Code.....	Pflanze
Lavatory complete as described.....	\$70.00
Weight each, lbs.....	280

Price for above Lavatory in Tennessee Marble same as for Italian.

Roughing-in Measurements:

Height from floor to top of slab, 30 inches; distance from face of finished wall to center of supplies, 3 inches; from face of finished wall to center of waste, 3 inches; from floor to center of supplies in wall, 15 inches; from floor to center of waste outlet in wall, 16 inches; center to center of supplies, 12 inches; supplies, ¾-inch iron pipe size.

† Carried in San Francisco only.

In Orders and Specifications give Plate Numbers.

MARBLE LAVATORY.

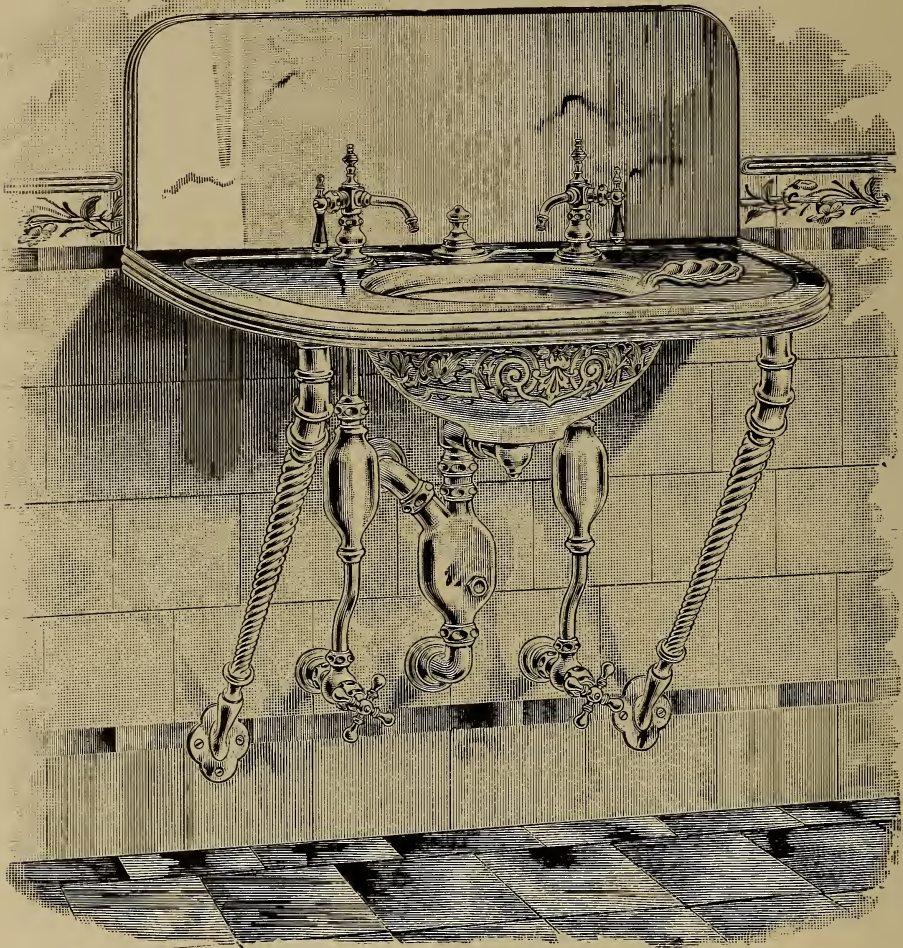

† 1014-C.

Light Tennessee Marble Countersunk Slab, 22 x 32 inches, 1¼ inches thick, with Shell Soap Cup. Triple Bead Moulding and 16-inch back; 14 x 17 Oval Bowl (Vitreous China), decorated inside and outside; Nickel-Plated No. 4 Improved Fuller Basin Cocks; Nickel-Plated Ideal Waste; Nickel-Plated Adjustable Supply Pipes with Improved Air Chambers and Stop Valves; Nickel-Plated Adjustable Standard Trap with Vent; Nickel-Plated Cast Brass Brackets and Braces to Wall; Screws and Basin Clamps.

Code.....	Plaster
Lavatory complete as described.....	\$67.50
Weight each, lbs.....

For plain China Basin instead of Decorated, deduct \$.

Marble Floor Slab extra.

Roughing-In Measurements :

Center to center of supplies, 12 inches; distance from floor to center of supplies in wall, 11 inches; from floor to center of waste outlet in wall, 6 inches; supplies, ¾-inch iron pipe size.

† Carried in San Francisco only.

In Orders and Specifications give Plate Numbers.

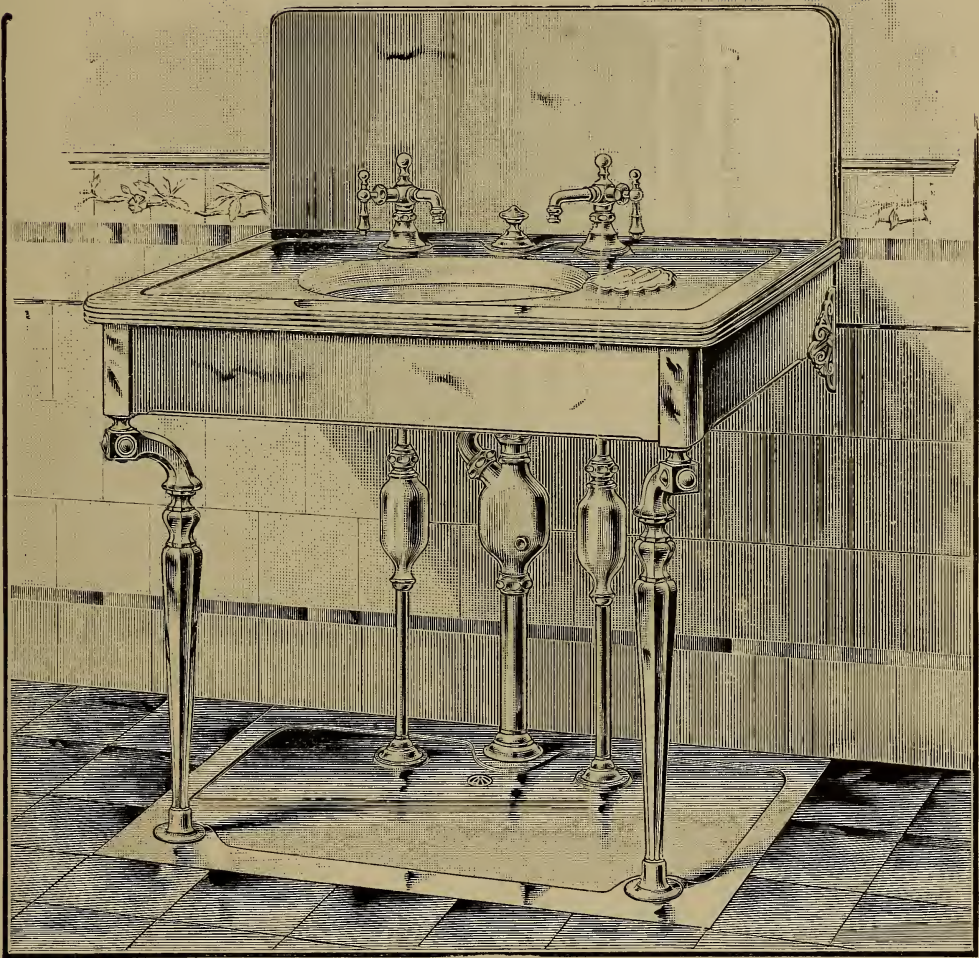
MARBLE LAVATORY.

† 1016-C.

Light Tennessee Marble Countersunk Slab, 22x32 inches, 1¼-inch thick, with Shell Soap Cup, Triple Bead Moulding, 16-inch Back and 5-inch Apron; 14x19-inch Ideal Decorated Bowl (Vitreous China); Nickel-Plated No. 10 Improved Fuller Basin Cocks; Nickel-Plated Ideal Waste; Nickel-Plated Adjustable Supply Pipes to Floor, with Improved Air Chambers; Nickel-Plated 1½-inch Standard Trap to Floor with Vent to Wall; Nickel-Plated Adjustable Offset Lavatory Legs; Nickel-Plated Apron Wall Supports; Screws and Basin Clamps.

Code	Pfaume
Lavatory complete as described.....	\$70.00
Shipping weight, lbs.....	200

Marble Floor Slab extra.

Roughing-in Measurements :

Center to center of supplies, 12 inches ; center of supplies to face of finished wall, 3¾ inches ; center of waste to face of finished wall, 3¼ inches ; supplies, ¾-inch iron pipe size.

† Carried in San Francisco only.

In Orders and Specifications give Plate Numbers.

MARBLE LAVATORY.



† 1018-C.

Light Tennessee Marble Countersunk Slab, 24 x 32 inches, 1¼-inch thick, with Ogee Moulding; 16-inch Back and 5-inch Aprons; 16-inch Round Decorated Bowl (Vitreous China); Nickel-Plated No. 8 Improved Fuller Basin Cocks; Nickel-Plated Unique Waste; Nickel-Plated Supply Pipes to Floor, with Supply Valves; Nickel-Plated 1½-inch Elliptical Trap to floor; Nickel-Plated Offset Lavatory Legs; Nickel-Plated Apron Supports; Screws and Basin Clamps.

Code.....	Pflege
Lavatory complete, as described.....	\$45.00
Shipping weight each, lbs.....	180
Code.....	Pflegelos
Marble Lavatory with Bowl and Clamps only.....	\$24.00

Price for above Lavatory in Italian Marble same as for Tennessee.

Roughing-in Measurements:

Distance from face of finished wall to center of supplies, 5¾ inches; from face of finished wall to center of waste, 3½ inches; center to center of supplies, 12 inches; supplies, ¾-inch iron pipe size.

† Carried in San Francisco only.

In Orders and Specifications give Plate Numbers.

MARBLE LAVATORY.

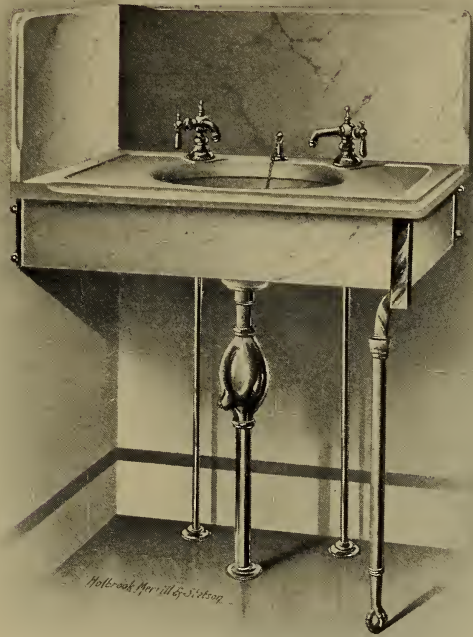

† 1021-C.

Italian Marble Countersunk Slab, 20 x 30 inches, 1¼-inch thick with Ogee Moulding; 12-inch Back and Left Hand End and 5-inch Aprons; 14 x 17 Oval Patent Overflow Bowl (Vitreous China), with Metal Plug and Rubber Stopper; Nickel-Plated No. 8 Improved Fuller Basin Cocks; Nickel-Plated Chain Stay and Chain; Nickel-Plated Supply Pipes to Floor; Nickel-Plated, 1½-inch Elliptical Trap to Floor; Nickel-Plated Offset Lavatory Leg; Nickel-Plated Apron Wall Supports; Screws and Basin Clamps.

Code Left Hand.....	Pflegist
Code Right Hand	Pflegord
Lavatory complete as described	\$38.00
Shipping weight, pounds.....	165

Code Left Hand.....	Pfleguord
Code Right Hand	Pflicht
Marble Lavatory with Bowl and Clamps only	\$22.80

Price of above Lavatory in Tennessee Marble, same as for Italian.

Roughing-in Measurements :

Distance from face of finished back wall to center of supplies, 3¾ inches ; from face of finished back wall to center of waste, 11 inches ; center to center of supplies, 12 inches ; supplies, ¾-inch iron pipe size.

† Carried in San Francisco only.

In Orders and Specifications give Plate Numbers.

MARBLE LAVATORY.



Holbrook Merrill & Stetson

† 1022-C.

Italian Marble Countersunk Slab, 20x30 inches, 1¼-inch thick, with Ogee Moulding and 10-inch Back; 14x17 Patent Overflow Oval Bowl, with Metal Plug; Nickel-Plated No. 1 Improved Fuller Basin Cocks; No. 11 Nickel-Plated Chain Stay and Basin Chain; Nickel-Plated Supplies to Wall with Stop Valves; Nickel-Plated 1½-inch Menlo P Trap; Nickel-Plated No. 53 16x18-inch Lavatory Brackets; Screws and Basin Clamps.

Code.....	Pflock
Lavatory complete as described.....	\$25.00
Shipping weight, lbs.....	135
Code.....	Pflogen
Marble Lavatory with Bowl and Clamps only.....	\$15.60

Price of above Lavatory in Tennessee Marble same as for Italian.

Roughing-in Measurements :

Distance from face of finished wall to center of supplies, 3¾ inches; from face of finished wall to center of waste, 11 inches; from floor to center of supplies in wall, 17½ inches; from floor to center of waste outlet in walls, 16 inches; center to center of supplies, 12 inches; supplies, ½-inch iron pipe size.

† Carried in San Francisco only.

In Orders and Specifications give Plate Numbers.

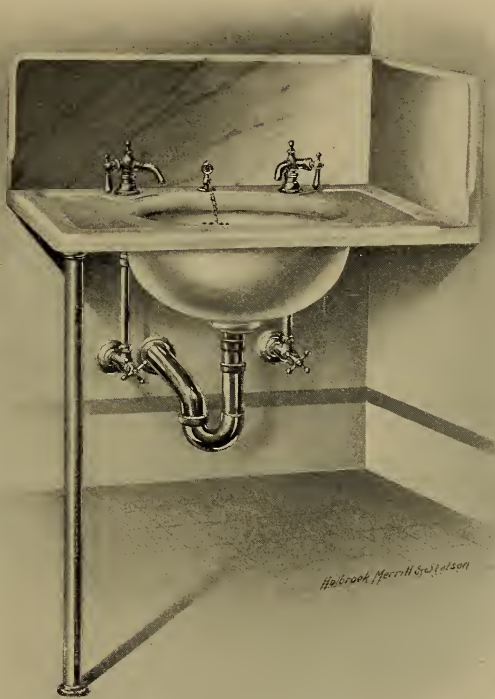
MARBLE LAVATORY

† 1025-C.

Tennessee Marble Countersunk Slab, 20x28 inches, 1¼-inch thick, with Ogee Moulding 10-inch Back and Right Hand End; 14x17 Patent Overflow Oval Bowl (Vitreous China) with Metal Plug; Nickel-Plated No. 0 Improved Fuller Basin Cocks; Nickel-Plated No. 11 Chain Stay and Basin Chain; Nickel-Plated Supplies to wall with Stop Valves; Nickel-Plated Adjustable P Trap; Nickel-Plated Straight Lavatory Leg; Basin Clamps and Screws.

Code, Right Hand	Pflugross
Code, Left Hand.....	Pflugstar
Lavatory complete as described	\$28.00
Shipping weight, lbs.....	100
Code, Right Hand ..	Pflugstock
Code, Left Hand.....	Pflugstump
Marble Lavatory with Bowl and Clamps only	\$18.50

Price for above Lavatory in Italian Marble same as Tennessee.

Roughing-in Measurements :

Distance from face of finished wall to center of supplies, 3¾ inches; from face of finished wall to center of waste, 11 inches; from floor to center of supplies in wall, 17½ inches; from floor to center of waste outlet in wall, 16 inches; center to center of supplies, 12 inches; supplies ½-inch iron pipe size.

† Carried in San Francisco only.

In Orders and Specifications give Plate Numbers.

MARBLE LAVATORY.



† 1026-C.

Italian Marble Countersunk Slab, 20x26 inches, 1¼ inches thick, with Ogee Moulding and 10-inch Back; 14-inch Round Patent Overflow Bowl with Metal Plug; Nickel-Plated No. 1 Improved Fuller Basin Cocks; Nickel-Plated No. 11 Chain Stay and Basin Chain; Nickel-Plated Supplies to Wall with Cross Handle Stops; Nickel-Plated 1½-inch Adjustable P Trap; Nickel-Plated Lavatory Brackets with Braces to Wall; Screws and Basin Clamps.

Code.....	Pfortader
Lavatory complete as described.....	\$23.00
Shipping weight, pounds.....	125
Code.....	Pfortsegl
Marble Lavatory with Bowl and Clamps only.....	\$13.50

Price of above Lavatory in Tennessee Marble same as for Italian.

Roughing-In Measurements :

Distance from face of finished wall to center of supplies, 3¾ inches; from face of finished wall to center of waste, 11 inches; from floor to center of supplies in wall, 17½ inches; from floor to center of waste outlet in wall, 16 inches; center to center of supplies, 12 inches; supplies, ½ inch iron pipe size.

† Carried in San Francisco only.

In Orders and Specifications give Plate Numbers.

MARBLE LAVATORY.



1027-C.

Italian Marble Quarter Circle Countersunk Slab 22 x 22 inches, 1¼ inches thick, with Plain Chamfer Moulding and 8-inch Backs; 14-inch Round Patent Overflow Bowl with Metal Plug; Nickel-Plated No. 0 Tee Handle Compression Basin Cocks; Nickel-Plated Supply Pipes to Wall; Nickel-Plated 1¼-inch Adjustable P Trap; Screws and Basin Clamps.

Code.....	Priem
Lavatory complete as described	\$15.50
Shipping weight, lbs.....	115

Roughing-in Measurements:

Distance from face of finished side wall to center of supplies, 3 inches; from face of finished side wall to center of waste, 9¾ inches; from floor to center of supplies in wall, 17½ inches; from floor to center of waste outlet in wall, 16 inches; center to center of supplies, 3 inches; supplies, ¾-inch iron pipe size.

In Orders and Specifications give Plate Numbers.

MARBLE BARBER SLABS.

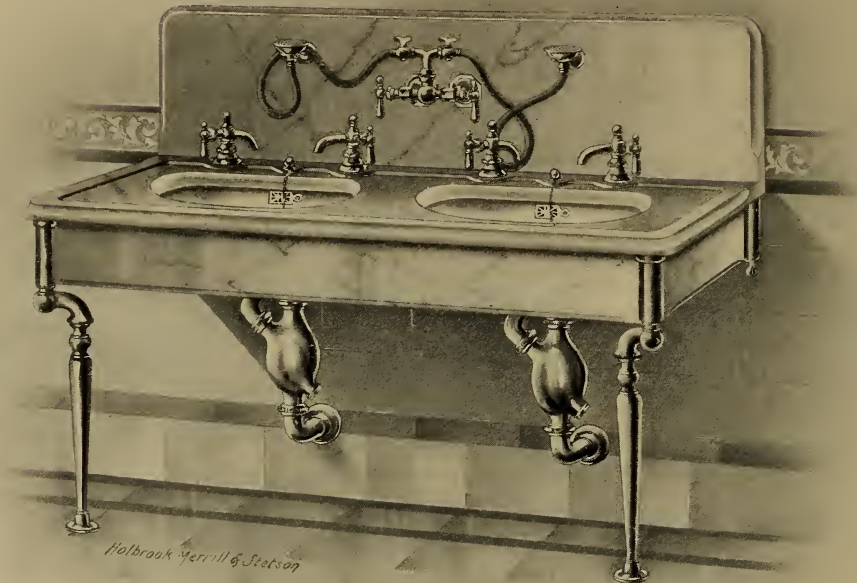

† 1030-C.

Italian Marble Countersunk Slab, 22x48 inches, 1¼ inches thick, with Ogee Moulding; 5-inch Aprons and 16-inch Back; 14x19 Straight Back D Basins (Vitreous China); Patent Overflow with Nickel-Plated Removable Overflow Strainers and Metal Plugs; Nickel-Plated No. 12 Improved Fuller Basin Cocks; Nickel-Plated Chain Stays and Chains; Special Design Nickel-Plated Improved Fuller Double Shampoo Faucet, with Hose and Sprinklers; Nickel-Plated 1½-inch Elliptical P Traps with Vents; Nickel-Plated Offset Lavatory Legs; Nickel-Plated Apron Supports; Screws and Basin Clamps.

Code.....	Pfunden
Lavatory complete as described.....	\$113.00
Shipping weight, lbs.....	270
Above Lavatory in Tennessee Marble same price as Italian.	

Barber Slabs of special sizes and designs made to order. Prices on application.

† Carried in San Francisco only.

In Orders and Specifications give Plate Numbers.

MARBLE BARBER SLABS.

† 1032-C.

Italian Marble Countersunk Slab, 24x48 inches, 1¼ inches thick, with Roll Edge and 5-inch Aprons; two 14x17 Patent Overflow Oval Basins (Vitreous China), with Metal Plugs and Basin Chains; Nickel-Plated Improved Fuller Combination Double Basin Cock with Shampoo Attachment, Rubber Hose and Sprinkler Holder and Rings for Chains; two Nickel-Plated Straight Supply Pipes; two 1½-inch Nickel-Plated Elliptical traps to floor; four Nickel-Plated Brass Offset Lavatory Legs with Braces; Brass Basin Clamps.

Code.....	Pfuschen
Complete as described.....	\$97.50
Shipping weight each, pounds.....	290

If with four No. 8 Fuller Basin Cocks and 1188-C Fuller Shampoo Cock, all with Nickel-Plated Supplies to floor, add \$5.00.

For Stop Valves in Supply Pipes, add for each \$1.00.

If with 14x19 Patent Overflow Straight Back D Basins, add \$2.50.

Above Lavatory in Tennessee Marble, same price as Italian.

† Carried in San Francisco only.

In Orders and Specifications give Plate Numbers.

MARBLE BASIN SLABS.

AMERICAN, ITALIAN OR TENNESSEE.

Our Stock of Marble Basin Slabs is all 1¼-inch Countersunk Marble with ⅞-inch Backs. The edges are all finished with a plain Chamfer Moulding. See 1044-C, page 289.

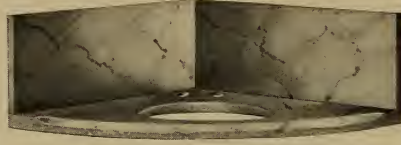

1033-C.

Quarter Circle or Corner Slab (with two backs), cut for 14-inch Bowl, Hot and Cold Water and Basin Clamps.

For 14-Inch Round Bowl With 8-Inch Backs.

Size, Inches.	Contents, Square Feet.		American.		Italian.		Tennessee.	
	Slab.	Backs.	Code.	Each.	Code.	Each.	Code.	Each.
18 x 18	2 ft. 6 in.	2 ft. 4 in.	Phacelina....	\$ 8.01	Phacopien ..	\$ 8.22	Phaeton.....	\$ 8.22
20 x 20	3 ft. 1 in.	2 ft. 8 in.	Phacium.....	9.44	Phacusa.....	9.89	Phagedena..	9.89
22 x 22	3 ft. 8 in.	2 ft. 11 in.	Phacodes ...	9.23	Phaenna.....	9.75	Phager.....	9.75
24 x 24	4 ft. 4 in.	3 ft. 2 in.	Phacolite....	12.57	Phaestios ...	13.14	Phagnalon..	13.14

For 14-Inch Round Bowl With 10-Inch Backs.

Size, Inches.	Contents, Square Feet.		American.		Italian.		Tennessee.	
	Slab.	Backs.	Code.	Each.	Code.	Each.	Code.	Each.
20 x 20	3 ft. 1 in.	3 ft. 3 in.	Phagonem ..	\$10.14	Phalacres....	\$10.62	Phaleron ...	\$10.62
22 x 22	3 ft. 8 in.	3 ft. 7 in.	Phagros.....	10.13	Phalangal..	10.58	Phalidure...	10.58
24 x 24	4 ft. 4 in.	3 ft. 10 in.	Phagrum....	13.38	Phalarica ...	14.00	Phaliga.....	14.00

For 14-Inch Round Bowl With 12-Inch Backs.

Size, Inches.	Contents, Square Feet.		American.		Italian.		Tennessee.	
	Slab.	Backs.	Code.	Each.	Code.	Each.	Code.	Each.
20 x 20	3 ft. 1 in.	3 ft. 10 in.	Phallene....	\$10.85	Phaloria.....	\$11.37	Phanagora..	\$11.37
22 x 22	3 ft. 8 in.	4 ft. 2 in.	Phaliques...	12.44	Phaltiel.....	13.04	Phanarum...	13.04
24 x 24	4 ft. 4 in.	4 ft. 6 in.	Phallorum..	14.16	Phameas ...	14.82	Phanocles...	14.82

For 14 x 17 Oval Bowl With 10-Inch Backs.

Size, Inches.	Contents, Square Feet.		American.		Italian.		Tennessee.	
	Slab.	Backs.	Code.	Each.	Code.	Each.	Code.	Each.
22 x 22	3 ft. 8 in.	3 ft. 7 in.	Phanothea..	\$11.94	Phaonis.....	\$12.54	Pharbitis...	\$12.54
24 x 24	4 ft. 4 in.	3 ft. 10 in.	Phansigar...	13.71	Pharacim ...	14.33	Pharcedon..	14.33

All quarter circle slabs will be shipped with 8-inch backs unless otherwise ordered.

In ordering Slabs, be particular to state whether American, Italian or Tennessee Marble is wanted; also whether drilled for one or two cock holes or chain stay; give size of bowl and whether round, oval or square.

For price of marble and extras for special slabs see page 290.

In Orders and Specifications give Plate Numbers and Sizes.

MARBLE BASIN SLABS.

AMERICAN, ITALIAN OR TENNESSEE.

Our stock of Marble Basin Slabs is all 1¼-inch Countersunk Marble with ⅞-inch Backs. The edges are all finished with a plain Chamfer Moulding. See 1044-C, page 289.



1034-C.



1036-C.

Single Back Slab cut for 14 inch Round Bowl, Hot and Cold Water and Basin Clamps.

Recess Slab with Back and two Ends. These Slabs vary so in size that they are only made to order.

For 14-Inch Round Bowl With 10-Inch Backs, 1034-C.

Size, Inches.	Contents, Square Feet.		American.		Italian.		Tennessee.	
	Slab.	Backs.	Code.	Each.	Code.	Each.	Code.	Each.
20 x 22	3 ft. 6 in.	1 ft. 10 in.	Pharillon....	\$ 9.27	Phascum.....	\$ 9.69	Phazemon ..	\$ 9.69
20 x 24	3 ft. 10 in.	2 ft. 0 in.	Pharisean...	10.17	Phasganon..	10.52	Pheasant....	10.52
20 x 26	4 ft. 1 in.	2 ft. 2 in.	Pharmaco...	10.88	Phasiron.....	11.34	Phedimes ...	11.34
20 x 28	4 ft. 5 in.	2 ft. 4 in.	Pharnaces...	11.75	Phasmien...	12.24	Phedons.....	12.24
20 x 30	4 ft. 8 in.	2 ft. 5 in.	Pharobank...	12.35	Phasquier...	12.87	Phedres.....	12.87
22 x 32	5 ft. 5 in.	2 ft. 7 in.	Pharology ..	13.07	Phatagin....	14.67	Phedrope ...	14.67
24 x 34	6 ft. 3 in.	2 ft. 9 in.	Pharsalia ...	15.96	Phaules.....	16.64	Phegeos.....	16.64
24 x 36	6 ft. 7 in.	2 ft. 11 in.	Phascolia ...	16.85	Phaulium....	17.56	Phegeum....	17.56

For 14x17-Inch Oval Bowl with 10-Inch Backs, 1034-C.

Size, Inches.	Contents, Square Feet.		American.		Italian.		Tennessee.	
	Slab.	Backs.	Code.	Each.	Code.	Each.	Code.	Each.
20 x 24	3 ft. 10 in.	2 ft. 0 in.	Phegidis.....	\$10.46	Phemius.....	\$10.82	Phenix.....	\$10.82
20 x 26	4 ft. 1 in.	2 ft. 2 in.	Phelline.....	11.18	Phenate.....	11.64	Phenol.....	11.64
20 x 28	4 ft. 5 in.	2 ft. 4 in.	Phellique....	12.08	Phengite....	12.60	Phenyle.....	12.60
20 x 30	4 ft. 8 in.	2 ft. 5 in.	Phellose.....	12.69	Phenicure...	13.23	Pherozes....	13.23
22 x 32	5 ft. 5 in.	2 ft. 7 in.	Phelsuma....	14.48	Pheniton....	15.08	Phetuse.....	15.08

In ordering Slabs be particular to state whether American, Italian or Tennessee Marble is wanted; also whether drilled for one or two cock holes or chain stay; give size of bowl and whether same is round, oval or square.

For price of marble and extras for special slabs, see page 290.
Special size marble slabs of any description made to order.

In Orders and Specifications give Plate Numbers and Sizes.

MARBLE BASIN SLABS.

AMERICAN, ITALIAN OR TENNESSEE.

Our stock of Marble Basin Slabs is all 1¼-inch Countersunk Marble with 7⁄8-inch Backs. The edges are all finished with a plain Chamfer Moulding.



1037-C.

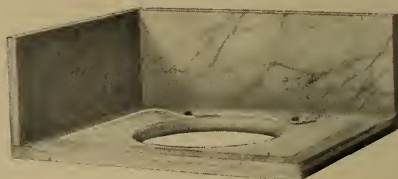

1039-C.

Slab with Back and Right-Hand End. (Cut for 14-inch round bowl, hot and cold water and basin clamps.)

Slab with Back and Left-Hand End. (Cut for 14-inch round bowl, hot and cold water and basin clamps.)

For 14-Inch Round Bowl with 10-Inch Backs, 1037-C.

Size, inches.	Contents, square feet.		American.		Italian.		Tennessee.	
	Slab.	Backs.	Code.	Each.	Code.	Each.	Code.	Each.
20 x 24	3 ft. 8 in.	3 ft. 6 in.	Phialia.....	\$11.63	Philately....	\$12.17	Philiberto...	\$12.17
20 x 26	3 ft. 11 in.	3 ft. 8 in.	Phidoles....	12.33	Philemata...	12.89	Philinna.....	12.89
20 x 28	4 ft. 3 in.	3 ft. 10 in.	Phigalea....	13.20	Philemon...	13.80	Philistim....	13.80
20 x 30	4 ft. 6 in.	3 ft. 11 in.	Philactis....	13.82	Philetam...	14.45	Philistos....	14.45
22 x 32	5 ft. 3 in.	4 ft. 3 in.	Philander...	15.47	Philetor.....	16.49	Philocali....	16.49

For 14-Inch Round Bowl with 10-Inch Backs, 1039-C.

Size, inches.	Contents, square feet.		American.		Italian.		Tennessee.	
	Slab.	Backs.	Code.	Each.	Code.	Each.	Code.	Each.
20 x 24	3 ft. 8 in.	3 ft. 6 in.	Philocome..	\$11.63	Philomache	\$12.17	Philophon.	\$12.17
20 x 26	3 ft. 11 in.	3 ft. 8 in.	Philocrene..	12.33	Philomedes.	12.89	Philosarca..	12.89
20 x 28	4 ft. 3 in.	3 ft. 10 in.	Philodices...	13.20	Philometor..	13.80	Philoscote...	13.80
20 x 30	4 ft. 6 in.	3 ft. 11 in.	Philodrome.	13.82	Philomot....	14.45	Philostize...	14.45
22 x 32	5 ft. 3 in.	4 ft. 3 in.	Philolog....	15.47	Philopator..	16.49	Philotera....	16.49

In ordering Slabs be particular to state whether American, Italian or Tennessee Marble is wanted; also whether drilled for one or two cock holes or chain stay; give size of bowl and whether same is round, oval or square.

For price of Marble and extras for special Slabs see page 290.

Special size Marble Slabs of any description made to order.

In Orders and Specifications give Plate Numbers and Sizes.

MARBLE BASIN SLABS.

AMERICAN, ITALIAN OR TENNESSEE.



1041-C.

Slab with Back and Left Hand End and with Apron on Front and Right Hand End (cut for three basins, hot and cold water, and chain stay for each.)

These Slabs can be made for any number of Basins, with Back and End, either right or left hand, and front Apron to suit ; or can be made with Back only and Apron on both ends and in front.

Where more than four Basins are wanted, the Slab will have to be made of two or more pieces of marble.

MOULDINGS FOR MARBLE BASIN SLABS.

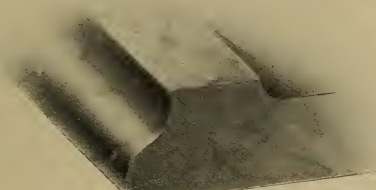

1042-C.

Sectional Cut Showing Ogee Moulding.

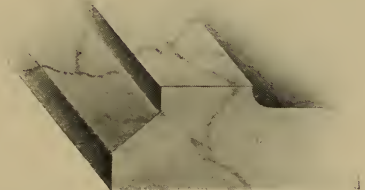

1043-C.

Sectional Cut Showing Fillet and Chamfer Moulding.

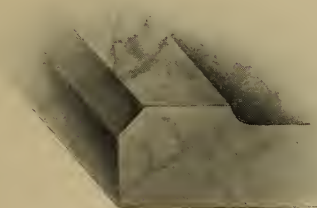

1044-C.

Sectional Cut Showing Plain Chamfer Moulding.

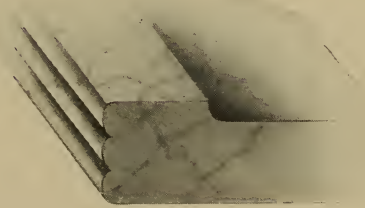

1045-C.

Sectional Cut Showing Triple Bead Moulding.

When ordering Lavatories be particular to state what kind of Moulding is wanted.

For prices of Mouldings see page 290.



1046-C.

SHELL SOAP DISH.

FOR MARBLE BASIN SLAB.

For cutting same on special slabs, \$3.75 and upwards.

For price of marble and extras for special slabs see page 290.

In Orders and Specifications give Plate Numbers.

MARBLE BASIN AND FLOOR SLABS.

COUNTERSUNK AND DRILLED.

	Blue and Light Cloud	Italian and Tennessee
1-inch (floor slabs only) per superficial foot.....	\$1.15	\$1.25
1 1/8 or 1 1/4 -inch.....	1.30	1.40
1 1/2 -inch.....	1.55	1.65
1 3/4 or 2-inch.....	2.45	2.55

All basins to have round bowls and drilled plain hot and cold water and chain stay. If oval or square bowls or special waste, see list of extras below. All quarter circle slabs figured as square slabs with two polished edges.

BACKS AND APRONS.

Per superficial foot, 3/4 or 7/8 inch.....	.75	.85
Circular apron, 22-inch quarter circle slabs, each.....	2.75	2.75
Circular apron, 24-inch quarter circle slabs, circle with extensions, each.....	3.25	3.25

No back figured at less than 8 inches, nor apron at less than 6 inches wide.

SINK SLABS.

FLUTED OR GROOVED WITH SQUARE HOLE.

1 1/4 -inch thick, per superficial foot.....	2.70	2.80
1 1/2 -inch thick, per superficial foot.....	2.95	3.05

SINK BACKS.

Plain 3/4 -inch or 7/8 -inch thick, per superficial foot.....	.75	.85
Cut to drain, 3/4 -inch or 7/8 -inch thick, per superficial foot.....	.80	.90
Bevel edge, 3/4 -inch or 7/8 -inch thick, per superficial foot.....	.85	.95

WAINSCOTTING AND PARTITIONS.

POLISHED ONE FACE, PER SUPERFICIAL FOOT.

Plain, in small lots, 3/4 -inch or 7/8 -inch thick.....	.75	.85
Plain, in small lots, 1 inch thick.....	.90	1.00
Plain, in small lots, 1 1/8 -inch or 1 1/4 -inch thick.....	1.05	1.15
Polishing extra faces, per superficial foot.....	.25	.25

EXTRAS. (Applying to all Marbles).

Cutting for oval bowl, with hot and cold water and chain stay, per superficial foot.....	.05
Cutting for square bowl, with hot and cold water and chain stay, per superficial foot.....	.10
Cutting for unique or any other special waste, per superficial foot.....	.10
Basin slabs with two or more holes, add to price including backs and aprons, per superficial foot.....	.20
All marble 9 feet long or over, add to above per superficial foot.....	.10
Extra countersinking, for each additional 1/4 -inch of sinkage, per superficial foot.....	.15
Shell soap dish cut in slabs, each.....	3.75
For fitting basin slabs to legs and apron supports, each slab.....	.75
Hand work on irregular slabs, per hour.....	.75
Grinding bowls, each.....	.10
Moulding Basin Slab Backs, per lineal foot.....	.25
Ogee, Fillet and Chamfer or Plain Chamfer Moulding on Basin Slabs.....	No charge
Triple Bead Moulding or Roll Edge on Basin Slabs.....	Time charged

Glossed edges always counted as 1 inch in measurement.
Fractional inches always counted as 1 inch in measurement.

BOXING.

Boxes containing single slabs or containing less than 15 superficial feet of marble, per each superficial foot.....	.10
Boxes containing 2 or more slabs and containing more than 15 superficial feet of marble, for each superficial foot.....	.05
No single box for less than.....	.50

Shipper must be the judge of the pieces most practicable to box together.
Prices for Slabs of other Marbles, Slate and Onyx on application.
One square foot of marble 1 inch thick weighs 15 lbs.

EARTHENWARE BASINS.

PLAIN WHITE.

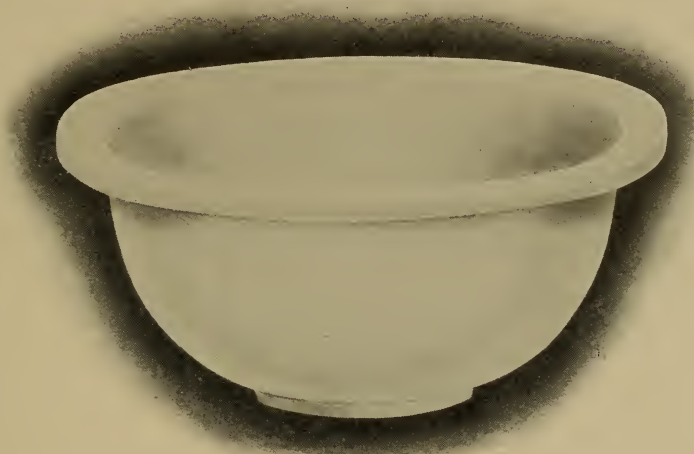

† 1047-C.

NO OVERFLOW, FOR METAL PLUG.

Code.....	Phlebetis	Phledale	Phlegma	Phlegmon	Phlegyas	Phleomys
Size, inch.....	10	12	13	14	15	16
Each.....	\$1.00	1.00	1.00	1.00	1.50	2.00
Weight each, lbs.....	4	6	8	10	11	13



† 1048-C.

COMMON OVERFLOW, FOR METAL PLUG.

Code.....	Phleophage	Phleopores	Phleotrupe
Size, inch.....	14	15	16
Each.....	\$1.00	1.50	2.00
Weight each, lbs.....	9	12	13

† Carried in San Francisco only.

In Orders and Specifications give Plate Numbers and Sizes.

EARTHENWARE BASINS.

PLAIN WHITE.

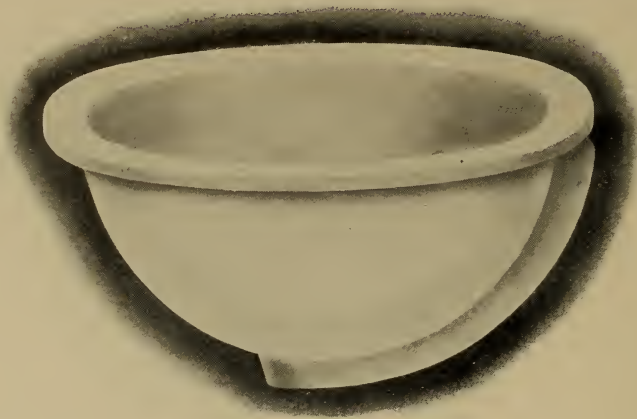

1049-C.

PATENT OVERFLOW FOR METAL PLUG.

Code.....	Phlogem	Phlogibus	Phloginos	Phlogistic	Phlogitide
Size, inch.....	†12	†13	14	†15	†16
Each.....	\$1.25	1.25	1.25	2.00	2.50
Weight each, lbs.....	7	8	9	12	14

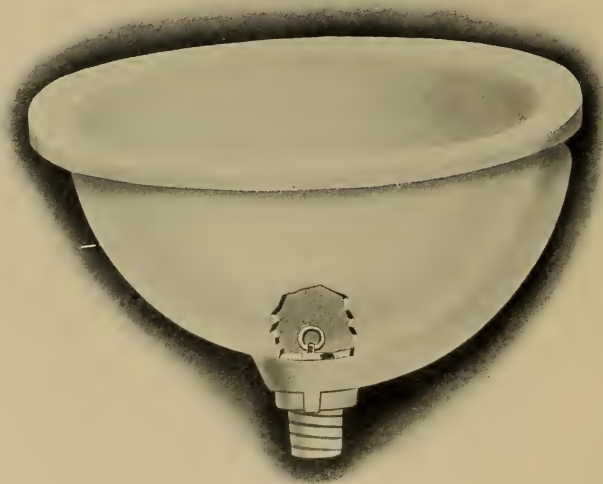

1050-C.

PATENT OVERFLOW FOR RUBBER PLUG.

Code.....	‡Phlomides	Phlomorum	Phlorizine	Phloroue
Size, inch.....	†12	†13	14	†16
Each.....	\$1.50	1.50	1.50	3.00
Weight each, lbs.....	7½	8½	10	12

† Carried in San Francisco only.

In Orders and Specifications give Plate Numbers and Sizes.

EARTHENWARE BASINS.

PLAIN WHITE.



1051-C.

PATENT OVERFLOW FOR METAL PLUG.

Code.....	Phlygone	Phlyse	Phobarum
Size, inches.....	14 x 17	15 x 19	† 16 x 21
Each.....	\$3.00	4.00	5.00
Weight each, lbs.....	13	14	16

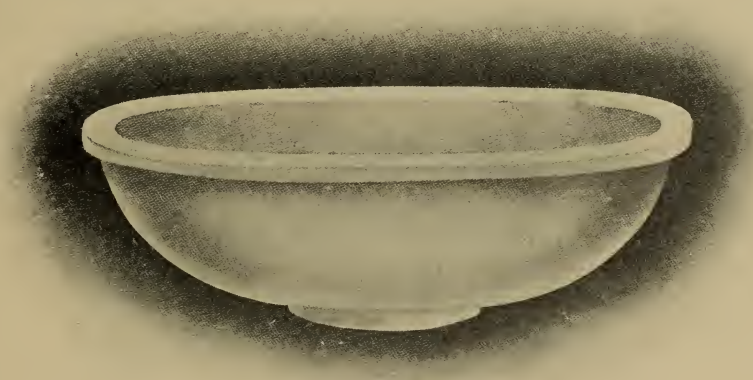

1052-C.

NO OVERFLOW FOR METAL PLUG.

Code.....	Phobetor	Phocidae	Phocidos
Size, inches.....	† 14 x 17	† 15 x 19	† 16 x 21
Each.....	\$2.50	3.50	4.50
Weight each, lbs.....	13	14	15

† Carried in San Francisco only.

In Orders and Specifications give Plate Numbers and Sizes.

EARTHENWARE BASINS.

PLAIN WHITE.

“Menlo” D Pattern Basin for “Menlo” Basin Waste, (Vitreous China.)

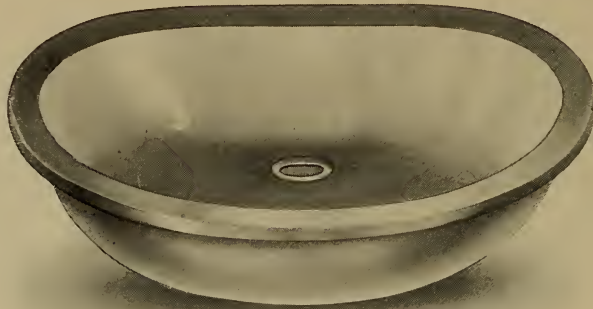

1053-C.

Code.....	Phocodon
Size, inch.....	† 14x19
Each.....	\$5.50
Weight each, lbs.....	16

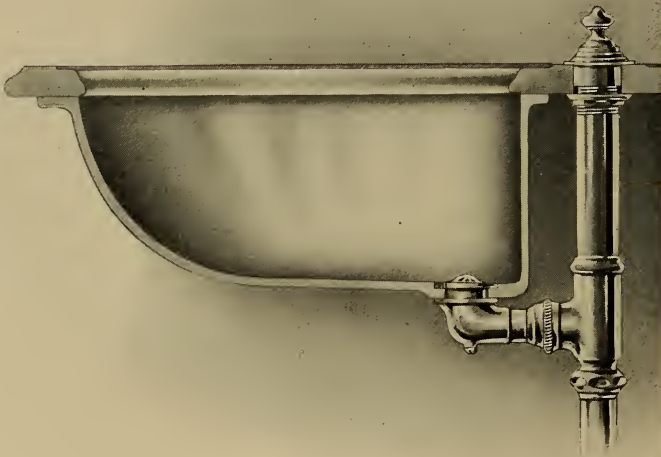

1054-C.

Cross Section of 1053-C.

The “Menlo” Basin is a new design. In shape it is a combination of the regular oval and straight back Basins. It is roomier than either, will keep cleaner and will empty more rapidly than any other Basin now in use.

The glaze on these Basins cannot, like that on regular ware, *craze, crack or peel off.*

† Carried in San Francisco only.

In Orders and Specifications give Plate Numbers.

PORCELAIN ENAMELED BASINS.

ENAMELED INSIDE. PAINTED OUTSIDE.



1060-C.

Round Patent Overflow with Nickel-Plated Waste Plug, Coupling and Rubber Stopper.

Code	Phodiles
Size, inch	14
Inside diameter, inch	12
Each	\$2.25
Weight each, lbs.....	14



1061-C.

Oval Patent Overflow with Nickel-Plated Strainer, Waste Plug, Coupling and Rubber Stopper.

Code.....	Phoenica	Phoestine
Size, inch.....	14x17	15x19
Inside dimensions, inch.....	12x15	13x17
Each	\$3.00	3.25
Weight each, lbs.....	20	24

In Orders and Specifications give Plate Numbers and Sizes.

PORCELAIN ENAMELED LAVATORY.

ENAMELED ALL OEVR.



1068-C.

Porcelain Enameled All Over Lavatory, with Slab, D Pattern Bowl and Apron, all in one piece; Porcelain Enameled All Over Pedestal; Nickel-Plated Torrance Pattern Fuller Basin Cocks, with China Handles and Indexes; Nickel-Plated Imperial Waste with China Index, Nickel-Plated Unique Trap to Wall, with Vent, Nickel-Plated Supply Pipes to Wall.

Code.....	Pholidote	Phollires
Size, inch.....	18x27	22x33
Size of bowl, inch	11x15	13x18
Width of apron, inch.....	5	5½
Lavatory complete as described.....	\$44.00	49.50
Shipping weight each, lbs	185	250
Shipping measurement, cubic feet.....	11¼	13⅝
Code.....	Phologoser	Phomothis
Lavatory with Imperial Waste and Pedestal only.....	\$30.50	36.00
Shipping weight, lbs.....	171	232

Packed in two cases, (Lavatory and Pedestal packed separately.)

In Orders and Specifications give Plate Numbers and Sizes.

PORCELAIN ENAMELED LAVATORY.

ENAMELED ALL OVER.



† 1070-C.

Porcelain Enameled All Over Lavatory, with Slab, Bowl and Apron all in one piece; Nickel-Plated Legs, with Wall Supports; Nickel-Plated Torrance Pattern Fuller Basin Cocks with China Handles and Indexes; Nickel-Plated Imperial Waste with China Index; Nickel-Plated Supply Pipes to Wall with Wheel Handle Angle Supply Valves; Nickel Plated Elliptical Trap to Wall.

Code.....	Phonalite
Size, inch.....	18x27
Size of bowl, inch.....	11 x 15
Width of apron, inch.....	5
Lavatory complete as described.....	\$45.50
Shipping weight each, lbs.....	150
Shipping measurement, cubic feet.....	5
Code.....	Phonascum
Lavatory with Nickel-Plated Legs, Wall Supports and Imperial Waste only.....	\$32.50
Shipping weight, lbs.....	100

One in a case.

† Carried in San Francisco only.

In Orders and Specifications give Plate Numbers.

PORCELAIN ENAMELED LAVATORY.

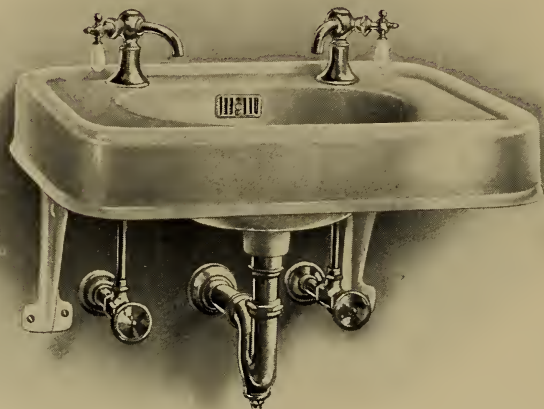

1072-C.

Porcelain Enameled Exterior Lavatory, with Slab, Apron, Oval Bowl and Overflow all in one piece, with Porcelain Enameled Brackets; Nickel-Plated Torrance Pattern Fuller Basin Cocks, with China Handles and Indexes; Nickel-Plated Overflow Strainer; Nickel-Plated Waste Plug with Rubber Stopper; Nickel-Plated 1½-inch Adjustable P Trap; Nickel-Plated Supply Pipes to Wall with Wheel Handle Angle Supply Valves.

This Lavatory is designed for use on marble or tile wainscoting, the brackets being adjusted to allow a space between wall and rear of fixture.

Code.....	Phonateur
Size, inch.....	18x24
Size of bowl, inch.....	12x15
Width of apron, inch.....	4
Lavatory complete as described.....	\$23.75
Shipping weight each, lbs.....	125
Shipping measurement, cubic feet.....	3 1/2

Code.....	Phonation
Lavatory with Brackets and Overflow Strainer only.....	\$12.50
Shipping weight, lbs.....	116

One in a case.

In Orders and Specifications give Plate Numbers.

PORCELAIN ENAMELED LAVATORY.**1074-C.**

Porcelain Enameled Exterior Lavatory, with Slab, Apron, Oval Bowl and Back all in one piece, Concealed Wall Hanger; Nickel-Plated Torrance Pattern Fuller Basin Cocks with China Handles and Indexes; Nickel-Plated Imperial Waste, with China Index; Nickel-Plated 1½-inch Elliptical Trap to Wall; Nickel-Plated Supply Pipes to Wall with Wheel Handle Angle Supply Valves.

Code.....	Phonetic	Phonic	Phonogram
Size, inch.....	†18x24	20x24	22x27
Size of bowl, inch.....	11½x16	12x15	12x15
Height of back, inch.....	11	12	12
Width of apron, inch.....	5	5	5
Lavatory complete as described.....	\$34.50	38.25	42.50
Shipping weight, lbs.....	143	170	185
Shipping measurement, cubic feet.....	9½	11½/₂	14¾

Size 18x24 inches furnished with Nickel-Plated Soap Dish on back.

Code.....	Phonoscope	Phontypic	Phonygame
Lavatory with Imperial Waste and Wall Hanger only.....	\$18.50	22.00	25.50
Shipping weight, lbs.....	128	152	170
† If Enameled all over, add.....	\$2.00	2.25	3.00

† Carried in San Francisco only.

In Orders and Specifications give Plate Numbers and Sizes.

PORCELAIN ENAMELED LAVATORY.



1076-C.

Porcelain Enameled Exterior Lavatory with Slab Apron, D Pattern Bowl, Overflow and Back all in one piece, with Concealed Wall Hanger; Nickel-Plated No. 8 Fuller Basin Cocks; Nickel-Plated Chain Stay and Chain; Nickel-Plated Waste Plug with Rubber Stopper; Nickel-Plated 1½-inch Adjustable P Trap to Wall; Nickel-Plated Supply Pipes to Wall with Wheel Handle Angle Supply Valves.

Code.....	Phoranthe	Phorasapis	Phorimes
Size, inch.....	18x24	20x24	22x27
Size of bowl, inch.....	12x15	12x15	12x15
Height of back, inch.....	10	12	12
Width of apron, inch.....	5	5	5
Lavatory complete as described.....	\$23.25	26.75	30.25
Shipping weight, lbs.....	140	165	180
Shipping measurement, cubic feet.....	9½	11½	14¾

Code.....	Phormion	Phoroneos	Phoroques
Lavatory with Wall Hanger and Strainer only.....	\$14.00	17.50	21.00
Shipping weight, lbs.....	128	152	170
† If enameled all over, add.....	\$2.00	2.25	3.00

One in a case.

† Carried in San Francisco only.

In Orders and Specifications give Plate Numbers and Sizes.

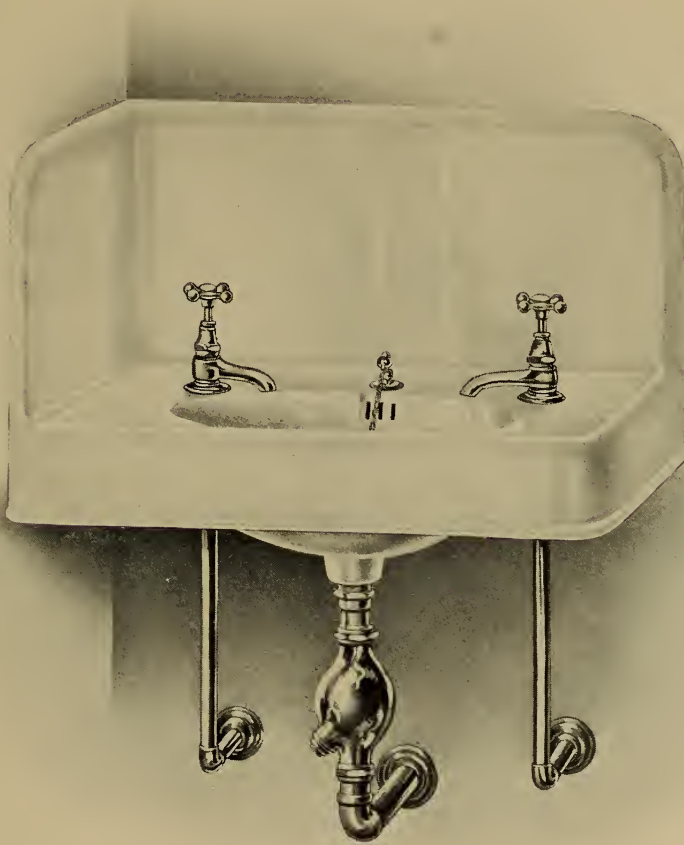
PORCELAIN ENAMELED LAVATORY.**1077-C.**

Porcelain Enameled Exterior Left Hand End Lavatory, with Slab, Apron, Bowl, Overflow, Back and Left-Hand End all in one piece, with Concealed Wall Hanger; Nickel-Plated Low Pattern Compression Basin Cocks with China Indexes; Nickel-Plated Chain Stay and Chain; Nickel-Plated Waste Plug with Rubber Stopper; Nickel-Plated 1½-inch Elliptical Trap to Wall; Nickel-Plated Supply Pipes to Wall.

Code.....	Phosphate	Phosphide	Photinia
Size, inch.....	18x24	† 20x24	† 22x27
Size of bowl, inch.....	12x15	12x15	12x15
Height of back, inch.....	10	12	12
Width of apron, inch.....	5	5	5
Lavatory, complete as described.....	\$27.00	31.00	35.50
Shipping weight, lbs.....	170	195	220
Shipping measurement, cubic feet.....	8⅓	11	13¼
Code.....	Photogene	Photologic	Photometre
Lavatory, with Wall Hanger and Chain Stay only.....	\$18.00	22.00	26.50
Shipping weight, lbs.....	155	180	205

One in a case.

† Carried in San Francisco only.

In Orders and Specifications give Plate Numbers and Sizes.

PORCELAIN ENAMELED LAVATORY.



1079-C.

Porcelain Enameled Exterior Right Hand Lavatory with Slab, Apron, Bowl, Overflow, Back and Right Hand End all in one piece, with Concealed Wall Hanger; Nickel-Plated Low Pattern Compression Basin Cocks with China Indexes; Nickel-Plated Chain Stay and Chain; Nickel-Plated Waste Plug with Rubber Stopper; Nickel-Plated 1½-inch Elliptical Trap to Wall; Nickel-Plated Supply Pipes to Wall.

Code.....	Phradates	Phranzes	Phraseman
Size, inch.....	18 x 24	+ 20 x 24	+ 22 x 27
Size of bowl, inch.....	12 x 15	12 x 15	12 x 15
Height of back, inch.....	10	12	12
Width of apron, inch.....	5	5	5
Lavatory complete as described.....	\$27.00	31.00	35.50
Shipping weight, lbs.....	170	195	220
Shipping measurement, cubic feet.....	8⅔	11	13¼
Code.....	Phraseurs	Phrasicles	Phrasimede
Lavatory with Wall Hanger and Chain Stay only.....	\$18.00	22.00	26.50
Shipping weight, lbs.....	155	180	205

One in a case.

Carried in San Francisco only.

In Orders and Specifications give Plate Numbers and Sizes.

PORCELAIN ENAMELED LAVATORY.

† 1081-C.

Porcelain Enameled Exterior Corner Lavatory with Slab, D Pattern Bowl, Overflow, Apron and Back a'l in one piece, with Concealed Wall Hangers; Nickel-Plated Standing Waste with China Index; Nickel-Plated No. 8 Fuller Basin Cocks with China Handles and China Indexes; Nickel-Plated 1½-inch Adjustable P Trap to Wall; Nickel-Plated Supply Pipes to Wall; Nickel-Plated Soap Dish.

Code.....	Phrasis
Length of sides, inch.....	16
Height of back, inch.....	7
Size of bowl, inch.....	11½ x 15½
Width of apron, inch.....	5
Lavatory complete as described.....	\$25.00
Shipping weight, lbs.....	125
Shipping measurement, cubic feet.....	6½ ₂
Code.....	Phratores
Lavatory with Soap Dish and Standing Waste only.....	\$14.75
Shipping weight, lbs.....	110

One in a case.

† Carried in San Francisco only.

In Orders and Specifications give Plate Numbers and Sizes.

PORCELAIN ENAMELED LAVATORY.

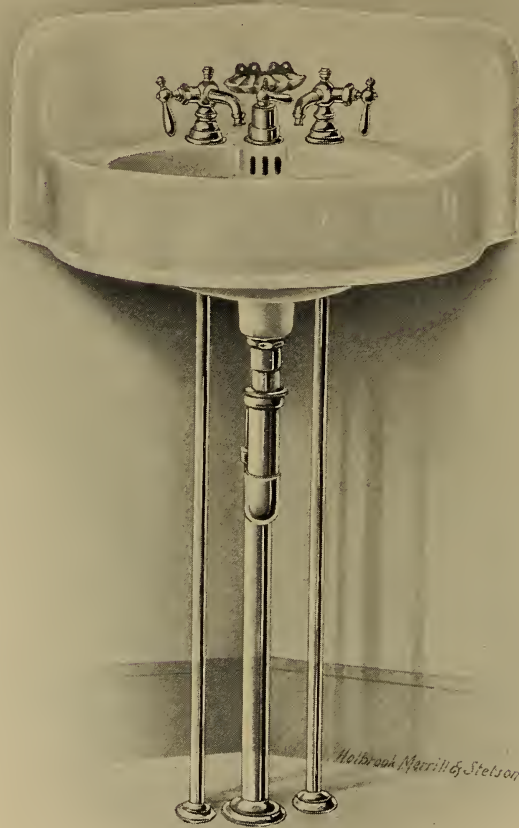

† 1083-C.

Porcelain Enameled Exterior Corner Lavatory with Slab, Oval Bowl, Overflow, Back and Apron all in one piece, with Concealed Wall Hangers; Nickel-Plated Keystone Waste; Nickel-Plated Monarch Pattern No. 0 Fuller Basin Cocks; Nickel-Plated 1½-inch Adjustable S Trap to Floor; Nickel-Plated Supply Pipes to Floor and Nickel-Plated Soap Dish.

Code.....	Phrenic
Length on side, inch.....	16
Size of bowl, inch.....	11x14
Height of back, inch.....	6
Width of Apron, inch.....	4½
Lavatory, complete as described.....	\$21.00
Shipping weight, pounds.....	105
Shipping measurement, cubic feet.....	4½
Code.....	Phrenitis
Lavatory with Keystone Waste and Soap Dish only.....	\$13.50
Shipping weight, pounds.....	95

If enameled all over, add \$2.00

One in a case.

† Carried in San Francisco only.

In Orders and Specifications give Plate Numbers.

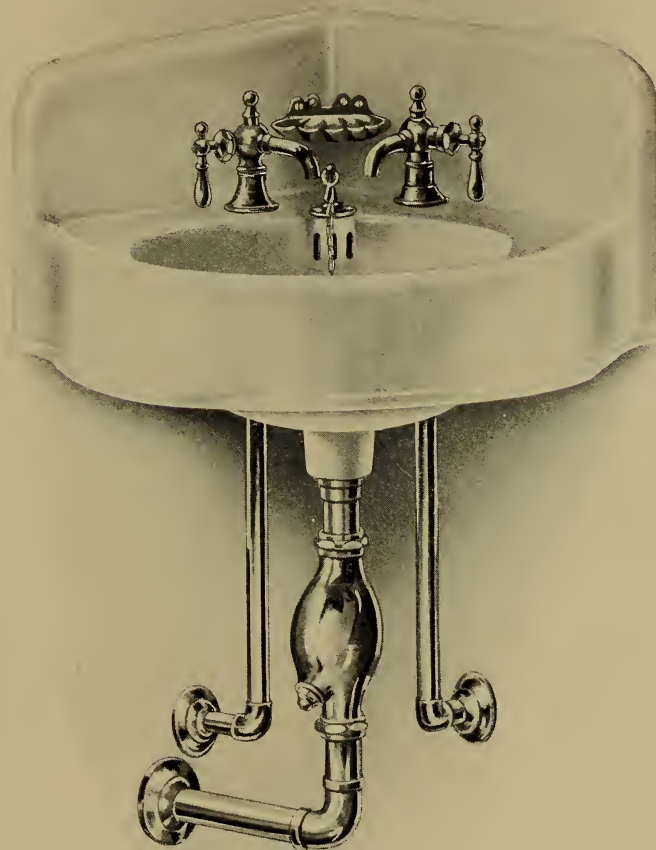
PORCELAIN ENAMELED LAVATORY.

† 1085-C.

Porcelain Enameled Exterior Corner Lavatory with Slab, Oval Bowl, Overflow, Back and Apron all in one piece, with Concealed Wall Hangers; Nickel-Plated No. 0 Fuller Basin Cocks; Nickel-Plated Chain Stay and Chain; Nickel-Plated Waste Plug with Rubber Stopper; Nickel-Plated 1½-inch Elliptical Trap to Wall; Nickel-Plated Supply Pipes to Wall; Nickel-Plated Soap Dish.

Code.....	Phrictes
Length on side, inch.....	16
Size of bowl, inch.....	11x14
Height of back, inch.....	6
Width of apron, inch.....	4½
Lavatory complete as described.....	\$18.00
Shipping weight, lbs.....	100
Shipping measurement, cubic feet.....	4¾
Code.....	Phrigius
Lavatory with Chain Stay and Soap Dish only	\$10.00
Shipping weight, lbs.....	90

One in a case.

† Carried in San Francisco only.

In Orders and Specifications give Plate Numbers.

PORCELAIN ENAMELED LAVATORY.



1086-C.

Porcelain Enameled Exterior Lavatory with Slab, D Pattern Bowl, Overflow, Apron and Back all in one piece, with Concealed Wall Hanger; Nickel-Plated 1182-C Fuller Basin Cocks with China Handles, Indexes and Unions; Nickel-Plated Overflow Strainer and Basin Chain; Nickel-Plated Waste Plug and Coupling with Rubber Stopper; Nickel-Plated 1½-inch Adjustable P Trap; Nickel-Plated Supply Pipes to Wall; Nickel-Plated Soap Dish.

Code.....	Phronima
Length, inch.....	21
Depth, inch.....	18
Size of bowl, inch.....	11 x 15
Height of back, inch.....	8
Width of apron, inch.....	4
Lavatory complete as described..	\$20.50
Shipping weight, lbs.....	140
Shipping measurement, cubic feet.....	6½

Code.....	Phrosine
Lavatory with Wall Hanger, Overflow Strainer and Soap Dish only.....	\$10.25
Shipping weight, lbs.....	125

One in a case.

In Orders and Specifications give Plate Numbers.

PORCELAIN ENAMELED LAVATORY.**1087-C.**

Porcelain Enameled Exterior Corner Lavatory, with Slab, D Pattern Bowl, Overflow, Back and Apron all in one piece, with Concealed Wall Hangers; Nickel-Plated Torrance Pattern Fuller Basin Cocks with China Handles and Indexes; Nickel-Plated Overflow Strainer and Basin Chain; Nickel-Plated Waste Plug with Rubber Stopper; Nickel-Plated 1½-inch Adjustable P Trap to Wall; Nickel-Plated Supply Pipes to Wall with Cross Handle Supply Valves; Nickel-Plated Soap Dish.

Code.....	Phrygian
Length on side, inch.....	19
Size of bowl, inch.....	11x15
Height of back, inch.....	8
Width of apron, inch.....	5
Lavatory complete as described.....	\$22.00
Shipping weight, lbs.....	135
Shipping measurement, cubic feet.....	6½ ₁₂
Code.....	Phrygibus
Lavatory with Wall Hangers, Overflow Strainer and Soap Dish only.....	\$10.75

One in a case.

In Orders and Specifications give Plate Numbers.

PORCELAIN ENAMELED LAVATORY.



† 1090-C.

Porcelain Enameled Exterior Lavatory with Slab, D Pattern Bowl, Overflow, Back and Apron all in one piece, with Secret Brackets; Nickel-Plated Buckeye Waste; Nickel-Plated Monarch Pattern No. 0 Fuller Basin Cocks; Nickel-Plated 1½-inch Elliptical Trap to Wall; Nickel-Plated Supply Pipes to Wall; Nickel-Plated Soap Dish.

Code.....	Phrynes
Size, inch.....	18x24
Height of back, inch.....	10
Size of bowl, inch.....	11½x16
Width of apron, inch.....	3
Lavatory complete as described.....	\$25.00
Shipping weight, lbs.....	145
Shipping measurement, cubic feet.....	6¾
Code.....	Phrynikos
Lavatory with Secret Brackets, Soap Dish and Buckeye Waste only.....	\$16.00
Shipping weight, lbs.....	130

One in a case.

† Carried in San Francisco only.

In Orders and Specifications give Plate Numbers.

PORCELAIN ENAMELED LAVATORY.

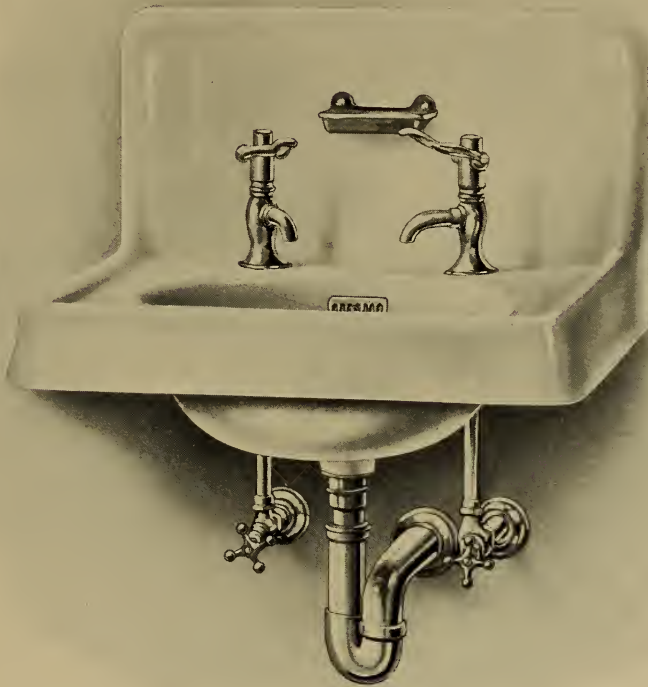

1092-C.

Porcelain Enameled Exterior Lavatory with Slab; D Pattern Bowl, Overflow, Back and Apron all in one piece, with Secret Brackets; Nickel-Plated Broughton Self-Closing Basin Cocks; Nickel-Plated Overflow Strainer; Nickel-Plated Waste Plug and Rubber Stopper; Nickel-Plated 1½-inch Adjustable P Trap to Wall; Nickel-Plated Supply Pipes to Wall with Cross Handle Supply Valves; Nickel-Plated Soap Dish.

Code.....	Phrynops	Phryscon
Size, inch.....	18 x 24	† 20 x 24
Size of bowl, inch	11½ x 16	11½ x 16
Height of back, inch.....	10	10
Width of apron, inch	3	3
Lavatory complete as described.....	\$27.75	30.25
Shipping weight, lbs.....	145	160
Shipping measurement, cubic feet.....	7½	8½
Code.....	Phygasia	Phygela
Lavatory with Secret Brackets, Soap Dish and Strainer only	\$12.50	15.00
Shipping weight, lbs.....	130	145

One in a case.

† Carried in San Francisco only.

In Orders and Specifications give Plate Numbers and Sizes.

PORCELAIN ENAMELED LAVATORY.

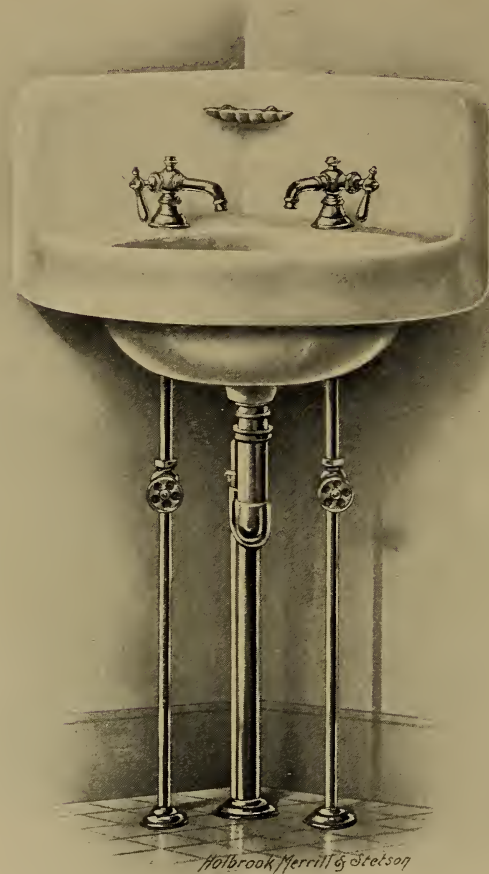

1093-C.

Porcelain Enameled Exterior Lavatory with Slab, Bowl, Overflow, Back and Apron all in one piece; Nickel-Plated Monarch Pattern No. 0 Fuller Basin Cocks; Nickel-Plated Overflow Strainer; Nickel-Plated Waste Plug with Rubber Stopper; Nickel-Plated 1½-inch Adjustable S Trap to Floor; Nickel-Plated Supply Pipes to Floor with Stops; Nickel-Plated Soap Dish.

Code.....	Phylastic	Phylarchos
Style.....	Oval Bowl	D Bowl
Length on side, inch.....	16	16
Size of bowl, inch.....	11½x15½	11½x15½
Height of back, inch.....	8	8
Width of apron, inch.....	3	3
Lavatory complete as described.....	\$19.25	19.25
Shipping weight, lbs.....	110	110
Shipping measurement, cubic feet.....	5⅙	5⅙
Code.....	Phylardast	Phylarque
Lavatory with Soap Dish and Strainer only	\$9.75	9.75
Shipping weight, lbs.....	100	100

One in a case.

In Orders and Specifications give Plate Numbers.

PORCELAIN ENAMELED LAVATORY.

DESIGNED FOR USE IN ALCOVES, CLOSETS AND WARDROBES IN OFFICES, HOTELS AND OTHER PUBLIC BUILDINGS.



† 1096-C.

Porcelain Enameled Exterior Recess Lavatory, with Slab, Oval Bowl, Overflow, Apron, Back and Ends all in one piece, with Concealed Wall Hangers; Nickel-Plated Torrance Pattern Fuller Basin Cocks, with China Handles and Indexes; Nickel-Plated Waste Plug with Rubber Stopper; Nickel-Plated 1½-inch P Trap to Wall; Nickel-Plated Supply Pipes to Wall with Wheel Handle Supply Valves.

Code.....	Phyllon	Phyllopes
Size, inch.....	20½x26	21x31
Size of bowl, inch.....	12x15	13x17
Height of back, inch.....	8	8
Width of apron, inch.....	5	5
Lavatory complete as described.....	\$31.50	36.50
Shipping weight, lbs.....	165	205
Shipping measurement, cubic feet.....	7½ ₁₂	10½ ₄
Code.....	Phyllopora	Phyllornis
Lavatory with Wall Hangers and Chain Stay only.....	\$20.25	25.25
Shipping weight, lbs.....	150	190

One in a case.

† Carried in San Francisco only.

In Orders and Specifications give Plate Numbers and Sizes.

PORCELAIN ENAMELED LAVATORY.



† 1098-C.

Porcelain Enameled Inside Lavatory with Slab, Oval Bowl, Overflow and Back all in one piece, with Brackets; Nickel-Plated No. 0 Monarch Pattern Fuller Basin Cocks; Nickel-Plated Chain Stay and Chain; Nickel-Plated Waste Plug with Rubber Stopper; Nickel-Plated 1½-inch Adjustable P Trap to Wall; Nickel-Plated Supply Pipes to Wall with Wheel Handle Supply Valves.

Code.....	Phyma	Phymatis	Phymosie	Phynon	Phypes
Size, inch.....	16x20	18x20	18x24	20x24	22x27
Size of bowl, inch.....	11x14	11x14	12x15	12x15	12x15
Height of back, inch.....	10	10	10	10	10
Lavatory complete as described.....	\$18.25	18.75	20.75	21.75	25.25
Shipping weight, lbs.....	110	120	135	146	165
Shipping measurement, cubic feet.....	7¾	8½	9⅓	10⅙	11½⅓

Code.....	Phyrama	Physalia	Physarum	Physcella	Physical
Lavatory with Brackets and Chain Stay only.....	\$10.00	10.50	12.50	13.50	17.00
Shipping weight, lbs.....	100	110	125	136	155

If with Concealed Wall Hanger instead of Brackets, deduct per pair \$0.50.

One in a case.

† Carried in San Francisco only.

In Orders and Specifications give Plate Numbers and Sizes.

PORCELAIN ENAMELED LAVATORY.



† 1100-C.

Porcelain Enameled Inside Lavatory with Slab, D Pattern Bowl, Back and Overflow all in one piece, with Concealed Wall Hanger; Nickel Plated No. 2 Fuller Basin Cocks; Nickel-Plated Overflow Strainer and Chain; Nickel-Plated Waste Plug with Rubber Stopper; Nickel-Plated 1½-inch Adjustable P Trap to Wall; Nickel-Plated Supply Pipes to Wall.

Code.....	Physique
Size, inch.....	19x24
Size of bowl, inch.....	12 x 15
Height of back, inch.....	10
Lavatory complete as described.....	\$17.75
Shipping weight, lbs.....	160
Shipping measurement, cubic feet.....	9½
Code.....	Physodie
Lavatory with Wall Hanger and Overflow Strainer only	\$11.00
Shipping weight, lbs.....	150

If enameled all over, add \$2.75.

One in a case.

† Carried in San Francisco only.

In Orders and Specifications give Plate Numbers.

PORCELAIN ENAMELED LAVATORY.

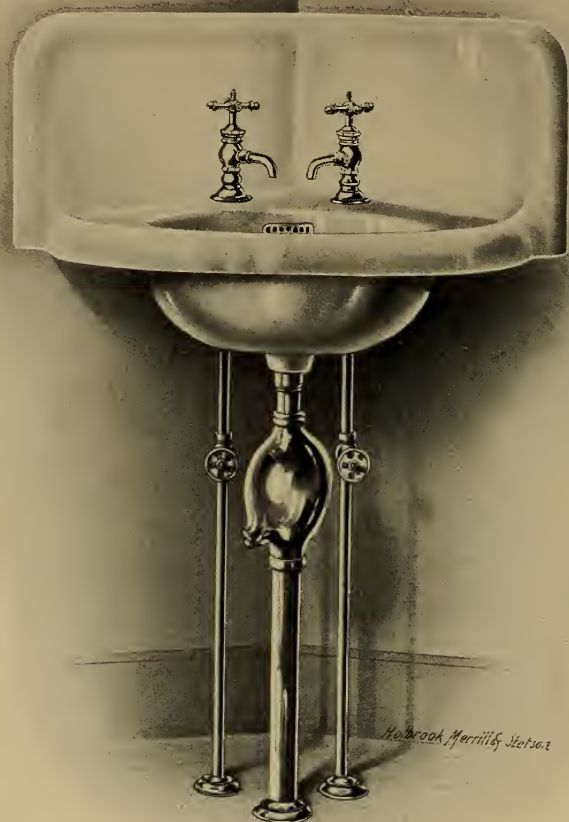

1103-C.

Porcelain Enameled Inside Corner Lavatory with Slab, D Pattern Bowl, Overflow and Back all in one piece; Nickel-Plated No. 4 Compression Basin Cocks with Cross Handles; Nickel-Plated Overflow Strainer and Chain; Nickel-Plated Waste Plug with Rubber Stopper; Nickel-Plated 1½-inch Elliptical Trap to Floor; Nickel-Plated Supply Pipes to Floor with Stop Valves.

Code.....	Phytalos
Length on side, inch	20
Size of Bowl, inch.....	12x15
Height of back, inch	10
Lavatory complete as described.....	\$21.50
Shipping weight, lbs	175
Shipping measurement, cubic feet.....	7⅔
Code.....	Phytoses
Lavatory with Overflow Strainer only	\$10.50
Shipping weight, lbs.....	160

† If Enameled all over, add \$2.00.
One in a case.

† Carried in San Francisco only.

In Orders and Specifications give Plate Numbers.

PORCELAIN ENAMELED LAVATORY.**1104-C.**

Porcelain Enameled Inside Lavatory with Slab, Bowl, Overflow and Back all in one piece, with Secret Brackets or Wall Hangers; Nickel-Plated No. 0 Monarch Pattern Fuller Basin Cocks; Nickel-Plated Overflow Strainer and Chain; Nickel-Plated Waste Plug with Rubber Stopper; Nickel-Plated 1½-inch Adjustable P Trap to Wall; Nickel-Plated Supply Pipes to Wall with Cross Handle Supply Valves; Nickel-Plated Soap Dish.

Code.....	Piabile	Piabuque
Style.....	Oval Bowl	D Bowl
Length, inch.....	21	21
Depth, inch.....	18	18
Size of bowl, inch.....	12 x 15	12 x 15
Height of back, inch.....	8	8
Lavatory complete as described.....	\$15.50	15.50
Shipping weight, lbs.....	135	135
Shipping measurement, cubic feet.....	4⅓	4⅝
Code.....	Piacento	Piacevole
Lavatory with Wall Hanger, Soap Dish and Overflow Strainer only.....	\$7.25	7.25
Shipping weight, lbs.....	120	120

† If Enameled all over, add \$2.75.

One in a case.

† Carried in San Francisco only.

In Orders and Specifications give Plate Numbers.

PORCELAIN ENAMELED LAVATORY.



† 1105-C.

Porcelain Enameled Inside Corner Lavatory with Slab, D Pattern Bowl, Overflow and Back all in one piece, with Concealed Wall Hangers; Nickel-Plated No. 0 Fuller Basin Cocks; Nickel-Plated Overflow Strainer and Chain; Nickel-Plated Waste Plug and Coupling with Rubber Stopper; Nickel-Plated 1½-inch Adjustable P Trap; Nickel-Plated Supply Pipes to Wall.

Code.....	Piacular
Length on side, inch.....	19
Size of bowl, inch.....	11x15
Height of back, inch.....	8
Lavatory complete as described.....	\$14.50
Shipping weight, lbs.....	128
Shipping measurement, cubic feet.....	6 ⁵ / ₁₂
Code.....	Piaculous
Lavatory with Wall Hangers and Overflow Strainer only	\$8.25
Shipping weight, lbs.....	118

One in a case.

† Carried in San Francisco only.

In Orders and Specifications give Plate Numbers.

PORCELAIN ENAMELED LAVATORY.



1107-C.

Porcelain Enameled Inside Corner Lavatory with Slab, Bowl, Overflow and Back all in one piece, with Concealed Wall Hangers; Nickel-Plated Doherty Self-Closing Basin Cocks; Nickel-Plated Overflow Strainer and Chain; Nickel-Plated Waste Plug with Rubber Stopper; Nickel-Plated 1½-inch P Trap to Wall; Nickel-Plated Supply Pipes to Wall with Cross Handle Supply Valves; Nickel-Plated Soap Dish.

Code.....	Piadosas	Piafaba
Style.....	Oval Bowl.	D Bowl.
Length on sides, inch.....	19	19
Size of bowl, inch.....	11x14	11x14
Height of back, inch.....	7	7
Lavatory complete as described.....	\$17.00	17.00
Shipping weight, lbs.....	105	105
Shipping measurements, cubic feet.....	4 $\frac{2}{3}$	4 $\frac{2}{3}$
Code.....	Piafador	Piafamos
Lavatory with Wall Hangers, Soap Dish and Overflow Strainer only.....	\$7.75	7.75
Shipping weight, lbs.....	95	95

One in case.

In Orders and Specifications give Plate Numbers.

PORCELAIN ENAMELED LAVATORY.



1108-C.

Porcelain Enameled Inside Lavatory with Slab, Oval Bowl, Overflow and Back all in one piece, with Secret Brackets or Wall Hanger; Nickel-Plated No. 0 Fuller Basin Cocks, Nickel-Plated Overflow Strainer and Chain; Nickel-Plated Waste Plug with Rubber Stopper; Nickel-Plated 1¼-inch Adjustable P Trap to Wall; Nickel-Plated Supply Pipes to Wall; Nickel-Plated Soap Dish.

Code.....	Piafarian
Length, inch.....	19
Depth, inch.....	13
Size of bowl, inch.....	11 x 14
Height of back, inch.....	6
Lavatory complete as described	\$12.50
Shipping weight, lbs.....	85
Shipping measurement, cubic feet.....	3¾
Code.....	Piaffiat
Lavatory with Wall Hanger, Soap Dish and Overflow Strainer only.....	\$6.50
Shipping weight, lbs.....	75

† If Enameled all over, add \$2.50.

If with Brackets in place of Wall Hangers, add \$0.50.

One in a case.

† Carried in San Francisco only.

In Orders and Specifications give Plate Numbers.

PORCELAIN ENAMELED LAVATORY.**1111-C.**

Porcelain Enameled Inside Lavatory with Slab, Oval Bowl, Overflow and Back all in one piece, with Concealed Wall Hangers; Nickel-Plated No. 0 Fuller Basin Cocks; Nickel-Plated Overflow Strainer and Chain; Nickel-Plated Waste Plug with Rubber Stopper; Nickel-Plated 1¼-inch Adjustable P Trap to Wall; Nickel-Plated Supply Pipes to Wall; Nickel-Plated Soap Dish.

Code.....	Piaffeur
Length on sides, inch.....	16½
Size of bowl, inch.....	11x14
Height of back, inch.....	6
Lavatory complete as described.....	\$13.00
Shipping weight, lbs.....	85
Shipping measurement, cubic feet.....	4 ⁵ / ₁₂
Code.....	Piagando
Lavatory, with Wall Hangers, Soap Dish and Overflow Strainer only.....	\$7.00
Shipping weight, lbs.....	75

† If Enameled all over, add \$2.00.

One in a case.

† Carried in San Francisco only.

In Orders and Specifications give Plate Numbers.

PORCELAIN ENAMELED LAVATORY.



1112-C.

Porcelain Enameled Inside Lavatory, with Slab, Round Bowl, Overflow and Back all in one piece; Nickel-Plated No. 0 Cross Handle Compression Basin Cocks; Nickel-Plated Overflow Strainer and Chain; Nickel-Plated Waste Plug with Rubber Stopper; Nickel-Plated 1¼-inch Adjustable S Trap to Floor; Nickel-Plated Supplies to Floor.

Code	Piagara
Length of back, inch.....	15
Diameter of bowl, inch.....	12
Height of back, inch.....	6
Lavatory complete as described.....	\$10.25
Shipping weight, lbs.....	50
Shipping measurement, cubic feet.....	2¼
Code	Piagasse
Lavatory with Overflow Strainer only	\$5.00
Shipping weight, lbs.....	40

One in a case.

In Orders and Specifications give Plate Numbers.

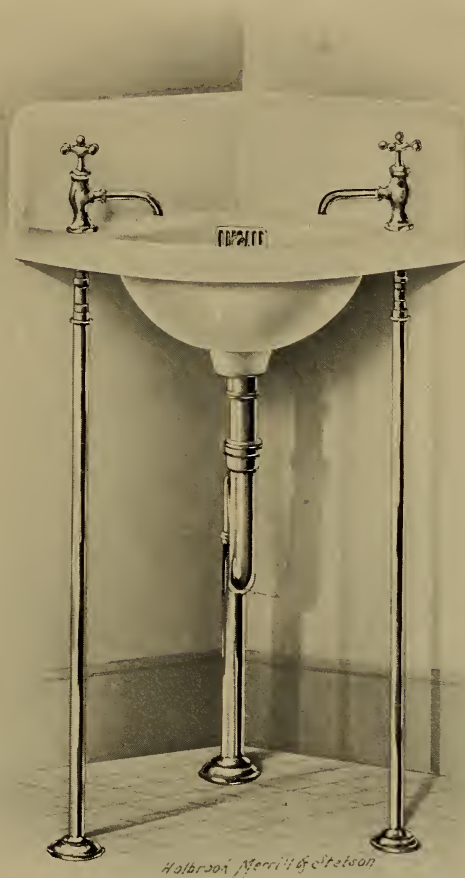
PORCELAIN ENAMELED LAVATORY.**1113-C.**

Porcelain Enameled Inside Corner Lavatory with Slab, Round Bowl, Overflow and Pack all in one piece; Nickel-Plated No. 0 Compression Basin Cocks with Cross Handles; Nickel-Plated Overflow Strainer and Chain; Nickel-Plated Waste Plug with Rubber Stopper; Nickel-Plated $1\frac{1}{4}$ -inch Adjustable S Trap to Floor; Nickel-Plated Supply Pipes to Floor.

Code.....	Piaghero
Length on sides, inch.....	15
Diameter of bowl, inch.....	12
Height of back, inch.....	6
Lavatory complete as described	\$10.25
Shipping weight, lbs.....	65
Shipping measurement, cubic feet.....	$3\frac{1}{2}$
Code.....	Piagnone
Lavatory with Overflow Strainer only	\$5.00
Shipping weight, lbs.....	55

One in a case.

In Orders and Specifications give Plate Numbers.

PORCELAIN ENAMELED SHIP LAVATORIES.



† 1116-C.

Porcelain Enameled All-Over Ship Lavatory and Receptor, with Slab, Splash Preventive Bowl and Back all in one piece, on Concealed Wall Hanger; Nickel-Plated Chain Stay, Chain and Waste Plug, with Rubber Stopper; Nickel-Plated Soap Dish.

Code.....	Piagoso
Width, inches.....	17 ½
Depth, inches.....	17
Bowl, inches.....	11 ½
Height of back, inches.....	3 ½
Complete as described.....	\$13.50
Weight each, lbs.....	140



† 1117-C.

Porcelain Enameled All-Over Corner Ship Lavatory and Receptor, with Slab, Splash Preventive Bowl and Back all in one piece, on Concealed Wall Hangers; Nickel-Plated Chain Stay, Chain and Waste Plug, with Rubber Stopper; Nickel-Plated Soap Dish.

Code.....	Piallatore
Length on side, inches.....	12 ½
Bowl, inches.....	11 ½
Height of back, inches.....	3 ½
Complete as described.....	\$13.50
Weight each, lbs.....	130

Either of above can be furnished enameled inside only for \$11.00.

† Carried in San Francisco only.

In Orders and Specifications give Plate Numbers.

PORCELAIN ENAMELED LAVATORIES.



1114-C.

Porcelain Enameled Lavatory with Slab, Bowl, Overflow and Back, all in one piece; Nickel-Plated Overflow Strainer; cut for Hot and Cold Water and Regular Pattern Basin Plug.

Length of Back, 13½ inches. Height of Back, 3½ inches. Diameter of Bowl, 12 inches.

Code.....	Piagnoxus
Each.....	\$4.00
Shipping weight, lbs.....	35

One in a case.



1115-C.

Porcelain Enameled Inside Corner Lavatory with Slab, Bowl, Overflow and Back all in one piece; Nickel-Plated Overflow Strainer. Cut for Hot and Cold Water and Regular Pattern Basin Plug.

Length of Side, 12 inches. Height of Back, 3½ inches. Diameter of Bowl, 12 inches.

Code.....	Piagnure
Each.....	\$4.00
Shipping weight, lbs.....	35

One in a case.

In Orders and Specifications give Plate Numbers.

PORCELAIN ENAMELED PRISON LAVATORIES.



† 1118-C.

Porcelain Enameled Inside Prison Lavatory with Slab, Bowl, Overflow and Back all in one piece; Nickel-Plated No. 1 Compression Basin Cock and Waste Plug with Rubber Stopper.

Length, 15 inches. Height of Back, 3 inches. Bowl, 10½x12 inches.

Code.....	Piallona	Code.....	Piamater
Lavatory complete as described.	\$5.00	Lavatory.....	\$8.75
Shipping weight, 35 pounds.			



† 1120-C.

Porcelain Enameled One-Piece Prison Lavatory with Overflow, Rubber Stopper and Waste Outlet threaded for Iron Pipe.

Length of Back, 12 inches. Height of Back, 4 inches.

Code.....	Piamina	Code.....	Piaminis
Lavatory Enameled all over.....	\$4.50	Lavatory Enameled inside.....	\$3.50
Shipping weight, 40 pounds.			

† Carried in San Francisco only.

In Orders and Specifications give Plate Numbers.

PORCELAIN ENAMELED LAVATORY.

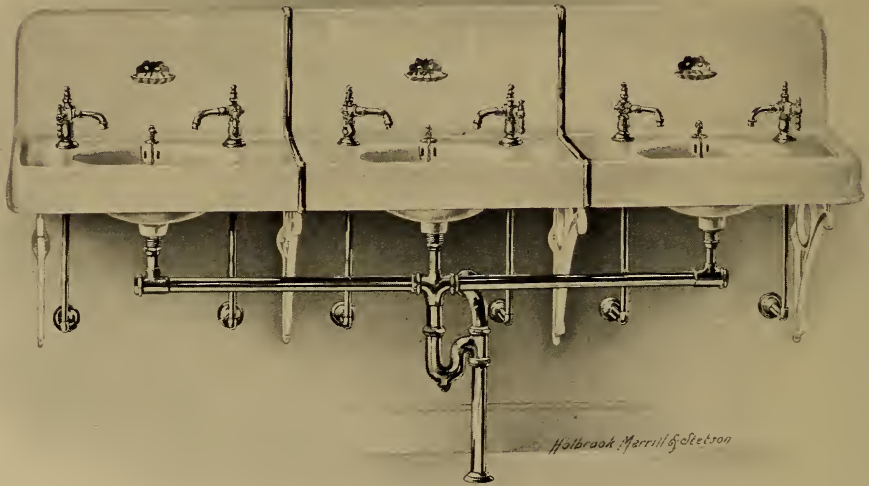

1124-C.

Porcelain Enameled Exterior Sectional Lavatory, with Slab, Bowl, Back, Overflow and Apron of each section all in *one piece*, with Enameled Brackets; Nickel-Plated Union Strips, Waste Plugs, Couplings, Chain Stays, Chains and Rubber Stoppers; Nickel-Plated No. 4 Fuller Basin Cocks; Supply Pipes; Continuous Waste and Vented S Trap; Nickel-Plated Soap Dishes.

Code.....	Piandos	Pianella
Size of each section, inches.....	18x24	20x24
Size of Bowl, inches.....	12x15	12x15
Height of Back, inches.....	12	12
Width of Apron, inches.....	5	5
Three sections complete as described.....	\$86.00	97.00
Weight of three sections, lbs.....	520	550
Code.....	Piangendo	Piangiate
Three sections with Chain Stays and Soap Dishes only	\$55.50	66.00
Each addition sectional with Chain Stay and Soap Dish only	18.50	22.00
Basin Cocks, Supply Pipes and Waste for each additional section.....	9.25	9.25

In Orders and Specifications give Plate Numbers and Sizes.

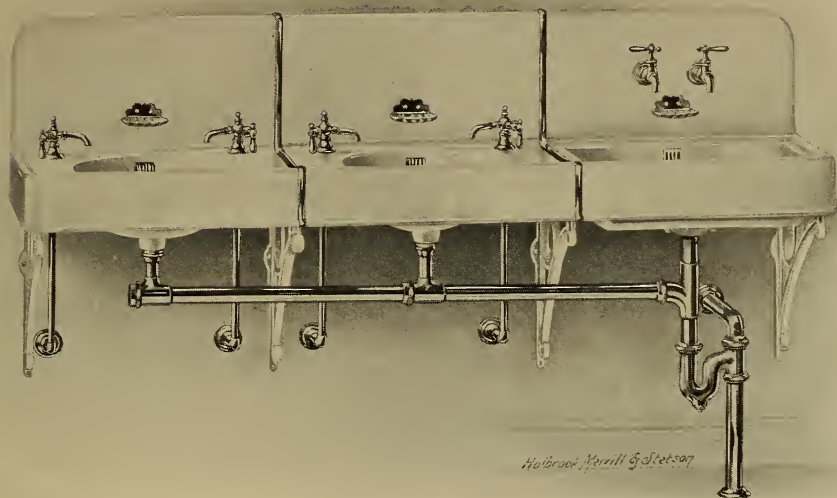
PORCELAIN ENAMELED LAVATORY.

† 1126-C.

Porcelain Enameled Exterior Lavatory with one Sink Section, Slab, Bowl, Overflow and Apron of each section all in one piece, separate Porcelain Enameled Backs and Brackets; Nickel-Plated Union Strips, Waste Plugs, Couplings and Rubber Stoppers; Nickel-Plated Fuller Bibbs and Flanges; No. 0 Fuller Basin Cocks; Supply Pipes; Continuous Waste and Vented S Trap; Nickel-Plated Soap Dishes.

Code.....	Pianograph
Size of each section, inches.....	18x24
Size of Bowls, inches.....	12x15
Size of Sink, inches.....	18x24
Height of Back, inches.....	12
Width of Apron, inches.....	5
Three sections complete as described.....	\$69.00
Shipping weight of three sections, lbs.....	367
Code.....	Pianospiel
Three sections with Backs, Union Strips, Brackets, Overflow Strainers and Soap Dishes only.....	\$46.50
Each additional section with Back, Union Strip, Bracket, Overflow Strainer, Plug and Soap Dish only.....	15.50
Basin Cocks, Supply Pipes and Waste for each additional Lavatory section.....	7.25
Bibbs and Waste for each additional Sink section.....	4.75

† Carried in San Francisco only.

In Orders and Specifications give Plate Numbers and Sizes.

PORCELAIN ENAMELED LAVATORY.

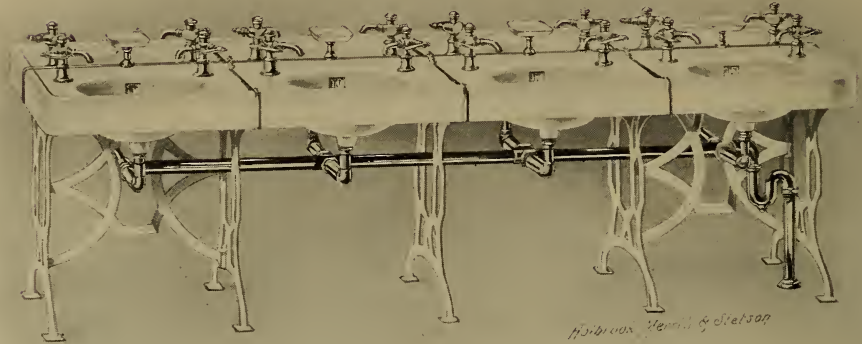

1128-C.

Porcelain Enameled Exterior Double Sectional Lavatory, with Slab, Bowl, Overflow and Apron of each section all in one piece, Painted or Bronzed Brackets to Floor; Nickel-Plated Waste Plugs, Couplings and Rubber Stoppers; Nickel-Plated Union Strips; Thatcher Pattern Self-Closing Basin Cocks; Continuous Waste and S Trap.

Code.....	Piantype	Piantale
Size, inches.....	18x24	22x27
Size Bowl, inches.....	12x15	12x15
Width of Apron, inches.....	5	5
Four Double Section Lavatory complete as described.....	\$190.80	210.80
Shipping weight, lbs.....		

Code.....	Piantarlo	Pianura
Four Double Section Lavatory with Legs, Union Strips and Soap Dishes only..	\$124.00	144.00
Each additional Double Section with Legs and Union Strips only	31.00	36.00
Basin Cocks, Pipes and Waste for each additional Double Section.....	15.25	15.25
Add for each Double Section enameled all over.....	5.00	5.50

In Orders and Specifications give Plate Numbers and Sizes.

PORCELAIN ENAMELED LAVATORY.

Halbrook Merrill & Sells

† 1130-C.

Porcelain Enameled Exterior Double Lavatory, with Slab, Bowls, Back and Apron all in one piece, with Concealed Wall Hanger; Nickel-Plated Torrance Pattern Fuller Basin Cocks, with China Handles and Indexes; Nickel-Plated Double Shampoo Cock, with China Handles; Nickel-Plated Imperial Waste with China Indexes; Nickel-Plated Supply Pipes, Elliptical Traps with Wastes and Vents to Wall; Nickel-Plated Soap Dishes.

Code.....	Pianuzzo
Size, inches.....	22x38
Bowl, inches.....	12x15
Back, inches.....	12
Width of Apron, inches.....	5
Lavatory complete as described.....	\$82.50
Code.....	Piarder
Lavatory with Wastes and Soap Dishes only	\$37.00
† Carried in San Francisco only.	

In Orders and Specifications give Plate Numbers.

PORCELAIN ENAMELED LAVATORY.

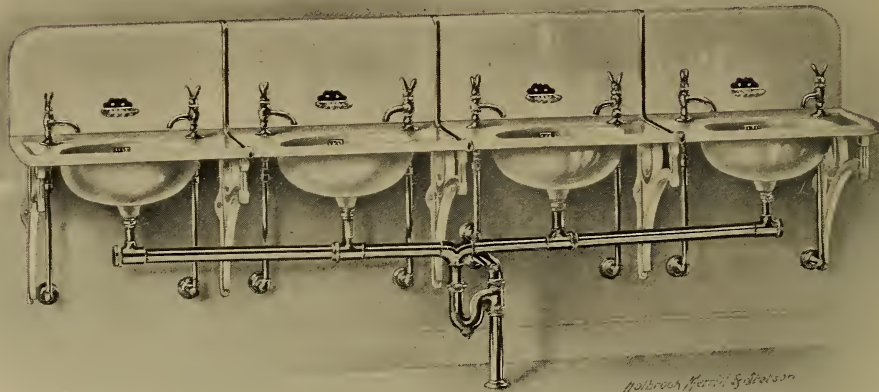

† 1132-C.

Porcelain Enameled Inside Sectional Lavatory, with Slab, Bowl and Overflow of each section all in one piece, Separate Enameled Backs; Painted or Bronzed Brackets; Nickel-Plated Union Strips; Waste Plugs; Couplings and Rubber Stoppers; Nickel-Plated Doherty Pattern Self-Closing Basin Cocks; Supply Pipes; Continuous Waste and Vented S Trap; Nickel-Plated Soap Dishes.

Code.....	Piastrella	Piastrone
Size, inches.....	16x20	18x24
Size of Bowl, inches.....	11x14	12x15
Height of Back, inches.....	12	12
Four Section Lavatory complete as described.....	\$78.00	86.00
Shipping weight, lbs.....	350	420
Code.....	Piatoris	Piatricem
Four Section Lavatory with Backs, Soap Dishes and Brackets only	\$40.00	48.00
Each additional section, with Back, Soap Dish and Bracket only.....	\$10.00	12.00
Basin Cocks, Pipes and Waste for each additional section.....	8.75	8.75

† Carried in San Francisco only.

In Orders and Specifications give Plate Numbers and Sizes.

PORCELAIN ENAMELED LAVATORY.

† 1185-C.

Porcelain Enameled Inside Sectional Lavatory, with Slab, Bowl and Overflow of each section all in one piece, Separate Porcelain Enameled Backs and Right Hand End Piece; Painted or Bronzed Brackets; Nickel-Plated Waste Plugs, Couplings and Rubber Stoppers; Nickel-Plated Union Strips; No. 6 Fuller Pattern Basin Cocks with Jewel Cups; Nickel-Plated Supply Pipes; Continuous Waste and Vented S Trap; Nickel-Plated Soap Dishes.

Code.....	Piattello	Piattono
Size, inches.....	16x20	18x24
Bowl, inches.....	11x14	12x15
Back, inches.....	12	12
Two Section Lavatory complete as described.....	\$51.00	55.00
Shipping weight, lbs.....	184	221
Code.....	Piauter	Piavimus
Two Section Lavatory with Backs, Brackets and Soap Dishes only	\$22.00	26.00
Each additional section with Back, Bracket and Soap Dish only	10.00	12.00
Basin Cocks, Supply Pipes and Waste for each additional section.....	12.75	12.75

† Carried in San Francisco only.

In Orders and Specifications give Plate Numbers and Sizes.

PORCELAIN ENAMELED LAVATORY.

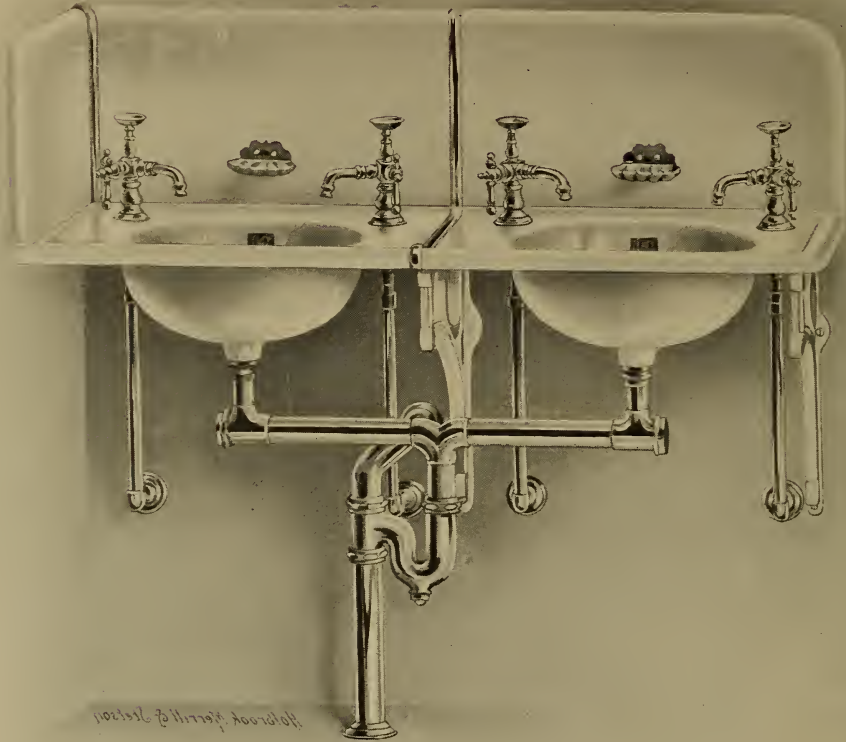

† 1137-C

Porcelain Enameled Inside Sectional Lavatory, with Slab, Bowl and Overflows of each section all in one piece; Separate Porcelain Enameled Backs and Left-Hand End Piece, Painted or Bronzed Brackets; Nickel-Plated Waste Plugs, Coupling and Rubber Stoppers; Nickel-Plated Union Strips; No. 6 Fuller Pattern Basin Cocks with Jewel Cups; Nickel-Plated Supply Pipes; Continuous Waste and Vented S Trap; Nickel-Plated Soap Dishes.

Code.....	Piazomias	Piazure
Size, inches.....	16x20	18x24
Bowl, inches.....	11x14	12x15
Back, inches.....	12	12
Two section Lavatory complete as described.....	\$51.00	55.00
Shipping weight, lbs.....	184	221
Code.....	Piazzata	Piboles
Two section Lavatory with Backs, Brackets and Soap Dishes only	\$22.00	26.00
Each additional section with Back, Bracket and Soap Dish only	\$10.00	12.00
Basin Cocks, Supply Pipes and Waste for each additional section	12.75	12.75

† Carried in San Francisco only.

In Orders and Specifications give Plate Numbers and Sizes.

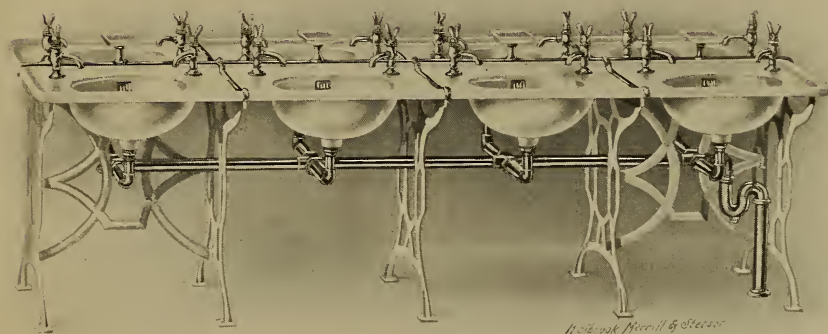
PORCELAIN ENAMELED LAVATORY.**1138-C.**

Porcelain Enameled Inside Double Sectional Lavatory, with Slab, Bowl and Overflow of each section in one piece; Porcelain Enameled Soap Dishes; Bronzed Iron Brackets to Floor; Nickel-Plated Union Strips; Doherty Pattern Self-Closing Basin Cocks; Continuous Waste and S Trap; Nickel-Plated Waste Plugs, Couplings and Rubber Stoppers.

Code.....	Pibroch	Picaroon
Size, inches	16x20	18x24
Bowl, inches.....	11x14	12x15
Four Double Section Lavatory complete as described.....	\$136.00	152.00
Shipping weight, lbs.....	380	460
Code.....	Picarote	Picaroso
Four Double Section Lavatory with Union Strips, Soap Dishes and Legs only	\$80.00	96.00
Each additional Double Section with Union Strips, Soap Dish and Legs only	\$20.00	24.00
Basin Cocks and Waste for each additional section.....	12.50	12.50
If Enameled all over add for each double section.....	5.00	5.00

In Orders and Specifications give Plate Numbers and Sizes.

PORCELAIN ENAMELED WASH SINKS.

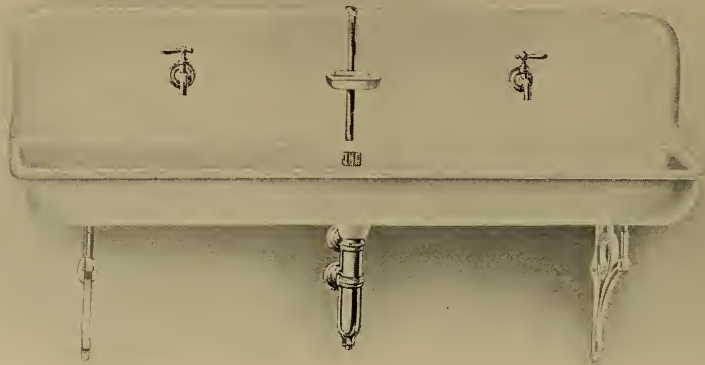

† 1140-C.

Porcelain Enameled Roll Rim Wash Sink on Brackets; Porcelain Enameled Back with Nickel-Plated Union Strip and Soap Dish; Nickel-Plated Overflow Strainer Waste Plug, Coupling and Rubber Stopper; Nickel-Plated Fuller Bibbs with Flanges, and P Trap with Waste and Vent to Wall.

Code.....	Piccavete
Length over Rim, inches	60
Width over Rim, inches	18
Depth, inches.....	6
Back, inches	12
Sink complete as described.....	\$33.50
Shipping weight, lbs.....	350

Code.....	Piccherai
Sink with Back, Union Strip, Brackets, Soap Dish, Overflow Strainer, and Plug only...	\$27.00

† Carried in San Francisco only.

In Orders and Specifications give Plate Numbers.

PORCELAIN ENAMELED WASH SINKS.

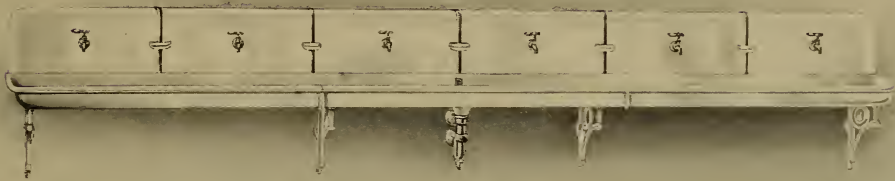

1142-C.

Porcelain Enameled Inside Roll Rim Sectional Wash Sink, Porcelain Enameled Back with Union Strips, Iron Brackets, Soap Dishes, Nickel-Plated Waste Plug and Coupling, Fuller Bibbs with Flanges and Vented P Trap.

Width inside, 14 inches ; width over rim, 18 inches ; back, 12 inches.

Code	Piccini	Picentium	Picenum	Piceous	Pichacha	Pichelero	Pichons
Sizes, feet	3	4	5	6	8	10	12
Sink, less Bibbs and Trap.....	\$24.00	25.00	27.00	32.40	43.20	54.00	64.80
Weight, lbs.....	150	200	250	300	400	500	600
Code.....	Pichurim	Pickaxe	Pickback	Pickeridge	Picklock	Pickmeise	Pickpurse
Size, feet.....	14	15	16	18	20	22	24
Sink, less Bibbs and Trap.....	\$75.60	81.00	86.40	97.20	108.00	118.80	129.60
Weight, lbs.....	700	750	800	900	1000	1100	1200

Add for Nickel-Plated Bibbs as shown, each, \$1.25.

There is approximately one Bibb for every thirty inches in length.

Add for Nickel-Plated Vented P Trap as shown, \$5.00.

May be furnished in longer lengths, also in painted or galvanized finishes if desired. Prices quoted upon application.

In ordering specify whether wanted with or without fittings shown.

In Orders and Specifications Give Plate Numbers and Sizes.

PORCELAIN ENAMELED WASH SINKS.

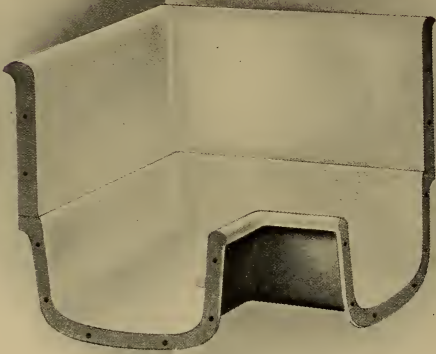

Porcelain Enameled Inside Corner Section for Roll Rim Wash Sink, with 12-inch Enameled Back.

Code.....	Pickthank
Each.....	\$25.00
Weight, each.....	...

Length of inside corner section of back, 4 feet; or 2 feet from either end to corner.

Other dimensions same as given on regular sectional Wash Sinks.

1145-C.

Porcelain Enameled Outside Corner Section for Roll Rim Wash Sink, with 12-inch Enameled Back.

Code.....	Picktooth
Each.....	\$25.00
Weight each, lbs.....	...

Length of outside corner section at front, 4 feet; or 2 feet from either end to corner.

Other dimensions same as given on regular sectional Wash Sinks.

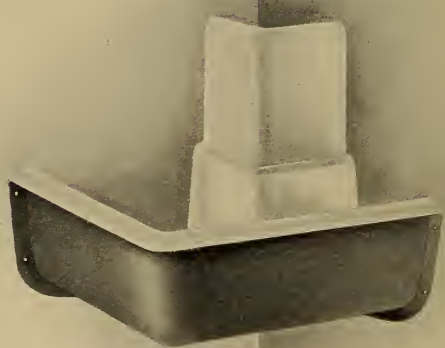

1147-C.

In Orders and Specifications give Plate Numbers.

PORCELAIN ENAMELED WASH SINKS.

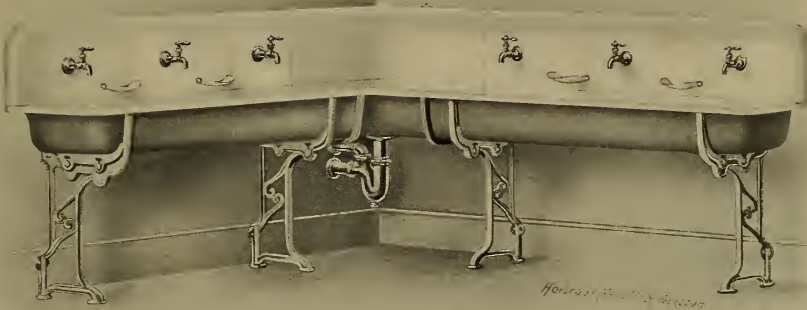

1149-C.

Porcelain Enameled Inside Corner Wash Sink on Adjustable Iron Frames, with Roll Rim, Porcelain Enameled Back; Nickel-Plated Waste Plug and Coupling; Soap Dishes; Nickel-Plated Fuller Bibbs with Flanges and Vented P Trap.

Dimensions:

Width of trough over all, 18 inches; width inside, 14 inches; height of back, 12 inches; length of inside corner section, 4 feet, or 2 feet from corner to each end.

Code.....	Picnostilo
Sink complete as described (length, corner to each end, 7 feet).....	\$95.50
Shipping weight, lbs.....

Code.....	Picnotico
Sink less Faucets and Trap	\$83.00

Can be furnished in longer lengths; also in painted or galvanized finishes if desired. (Prices quoted upon application.)

In Orders and Specifications give Plate Numbers.

PORCELAIN ENAMELED WASH SINKS.



1151-C.

Porcelain Enameled Wash Sink on Adjustable Iron Frames, with Roll Rim, Porcelain Enameled Back; Nickel-Plated Waste Plug and Coupling; Soap Dishes; Nickel-Plated Fuller Bibbs with Flanges and Vented P Trap.

Dimensions :

Width of trough over all, 18 inches; width inside, 14 inches; height of back, 12 inches; length of outside corner section, 4 feet, or 2 feet from corner to each end.

Code.....	Picolapte
Sink complete as described (length, corner to each end, 7 feet).....	\$95.50
Shipping weight, lbs.....

Code.....	Piconero
Sink, less Faucets and Trap.....	\$83.00

Can be furnished in longer lengths; also in painted or galvanized finishes if desired. (Prices quoted upon application.)

In Orders and Specifications give Plate Numbers.

PORCELAIN ENAMELED DRINKING FOUNTAINS.

Porcelain Enameled All Over Alcove Drinking Fountain with Nickel-Plated Boston Pattern Self-Closing Faucet, Open Strainer and Waste Connection to Wall.



† 1152-C.

For use in office buildings, schools, public institutions, hotels, etc.

Dimensions :

Height, 22 inches; width, 12¾ inches.

Recess in wall, 3½ inches; front to back, 10½ inches.

Code.....	Picorant
Complete as described.....	\$12.00
Weight each, lbs.....	32
Shipping measurement, cubic feet.....	...
Code.....	Picosas
Each, less Faucet.....	\$10.00

Porcelain Enameled All Over Flat Back Drinking Fountain, with Concealed Wall Hanger and Nickel-Plated Boston Pattern Self-Closing Faucet, Open Strainer and Waste Connection to Wall.

Dimensions :

Height, 22 inches; width, 12½ inches; depth from front to back, 9 inches.

Code.....	Picotadas
Complete as described.....	\$10.00
Weight each, lbs.....	28
Shipping measurement, cubic feet.....	...
Code.....	Picotazos
Each, less Faucet.....	\$8.00

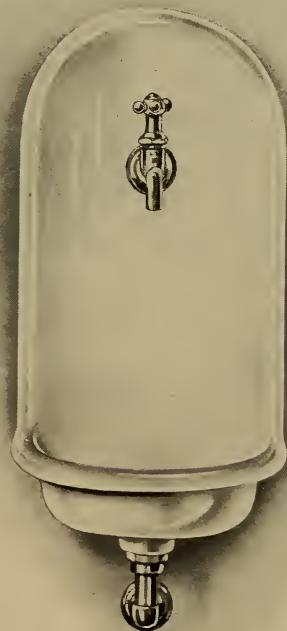

† 1154-C.

† Carried in San Francisco only.

In Orders and Specifications give Plate Numbers.

PORCELAIN ENAMELED DRINKING FOUNTAINS.

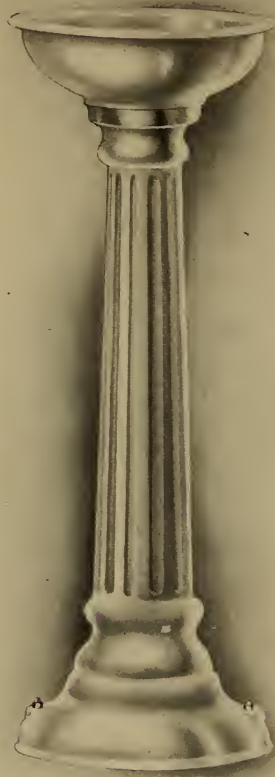

1156-C.

Porcelain Enameled Drinking Fountain, with Nickel-Plated Water Jet Cup.

For use in schools, public institutions and all places where drinking cups would not be considered sanitary.

Dimensions :

Outside diameter of bowl, 13½ inches ; depth of bowl, 4 inches.

Code.....	Picramique	Picramnie
Height, inches.....	30	36
Enameled all over as described, less Supply and Waste Pipes.....	\$18.00	20.00
Code	Pictavam	Pictavos
Enameled inside exterior of Basin and Pedestal painted, as described, less Supply and Waste Pipes.....	\$13.00	15.00

If with Concealed Galvanized Supply and Waste Pipes, as shown in cross section view 1157-C, add \$2.50.



1157-C.
Cross Section.

In Orders and Specifications Give Plate Numbers.

FOLDING SHIP LAVATORY.



† 1160-C. Open.

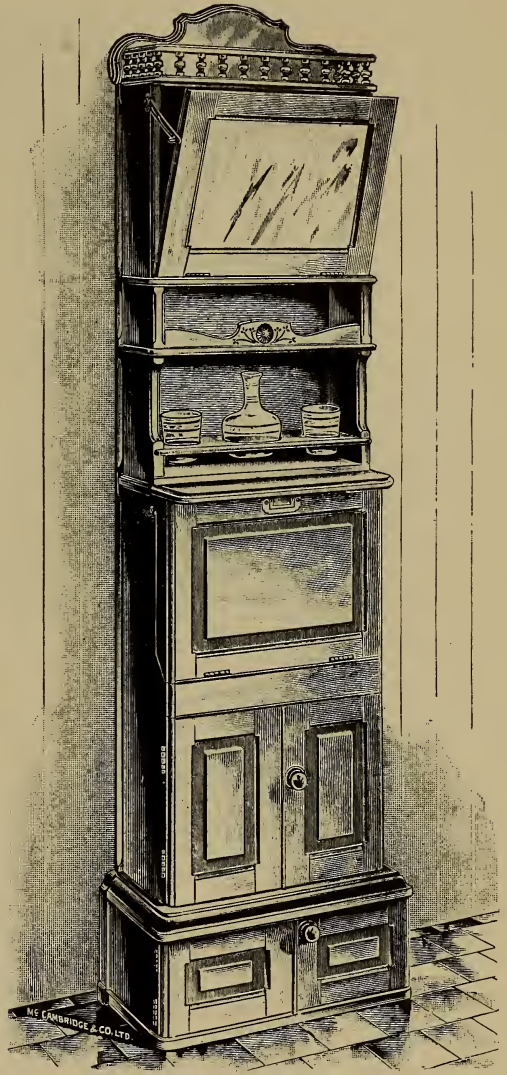

† 1160-C. Closed.

Quartered Oak Cabinet with French Plate Mirror; Heavy Zinc Water Tank and Galvanized Iron Slop Receiver; Nickel-Plated Brass Self-Closing Faucet; Vitreous China Wash Bowl and Soap Cups.

Dimensions :

Height, 6 feet, 3 inches; width, 21 1/2 inches; depth front to back when closed, 11 inches; when open, 23 inches; capacity of water tank, 3 1/2 gallons.

Code.....	Pictoricas
Complete as described (without water bottle or glasses).....	\$60.00
Shipping weight, lbs.....
Shipping measurement, cubic feet.....

One in a case.

† Carried in San Francisco only.

In Orders and Specifications give Plate Numbers.

FOLDING SHIP LAVATORY.

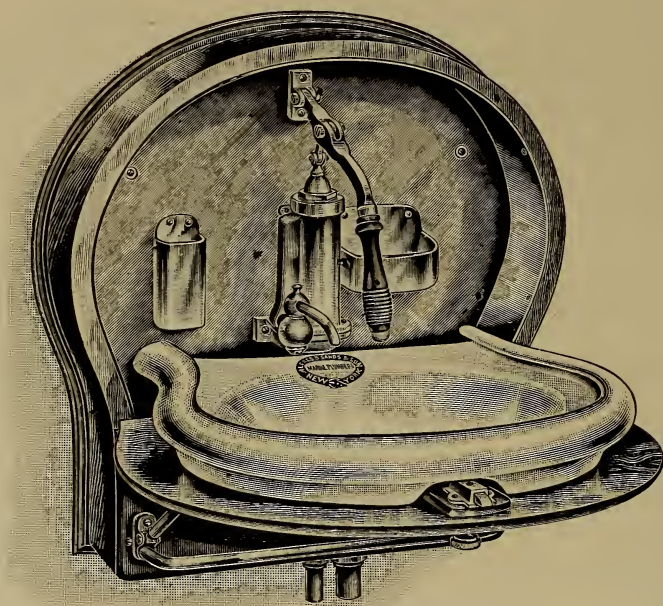

† 1162-C.

Mahogany Case, White Porcelain Oval Basin; Nickel-Plated Copper Lining; Soap Cup and Brush Holder; Nickel-Plated Brass Pump, Towel Rack and Trimmings.

Supply for Lavatory may be taken from tanks under floor, or, if on fresh water, may be taken from directly outboard.

The waste may discharge either into bowls of water-closet, waste tank, or directly overboard.

Dimensions :

Height, 20 inches; width, 19 inches; depth, front to back when closed, 6 inches; when open, 18 inches; oval basin, 12x15 inches.

Code.....	Pictura
Complete as described	\$60.00
Shipping weight each, lbs.....	56

Can be furnished in any wood desired.

† 1164-C. (Not shown.)

Same fixtures as 1162-C with Nickel-Plated Self-Closing Faucet instead of Pump.

To be supplied from overhead tank or pressure.

Code.....	Pictural
Each.....	\$45.00
Shipping weight, lbs.....	49

† Carried in San Francisco only.

In Orders and Specifications give Plate Numbers.

FOLDING SHIP LAVATORY.

† 1166-C.

Mahogany Case with Nickel-Plated Copper Basin and Lining; Nickel-Plated Brass Pump, Soap Cup, Brush Holder, Towel Bar and other Trimmings.

Supplies may be taken from tanks under cabin floor, or from outboard, if boat is on fresh water, discharging either into waste receiver, water-closet bowl, or directly overboard.

Dimensions :

Height of case over all, 19½ inches; width of case, 15 inches; depth of case, front to back, 3½ inches; depth over all to face of basin, 5½ inches; depth over all when open, 16½ inches; diameter of basin, 10 inches.

Code.....	Picudilla
Lavatory complete as shown and described.....	\$52.50
Shipping weight, lbs.....	39
Shipping measurement, cubic feet.....

One in a case.

† 1168-C (not shown).

Same fixture as 1166-C with Nickel-Plated Self-Closing Faucet, instead of Pump.

To be supplied from overhead tank or pressure.

Code.....	Picudos
Each.....	\$37.50
Shipping weight, lbs.....	35

† Carried in San Francisco only.

In Orders and Specifications give Plate Numbers.

FULLER BASIN COCKS.

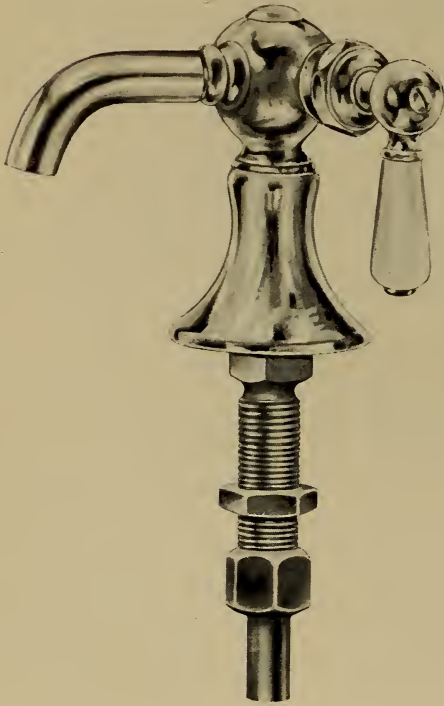

1170-C.

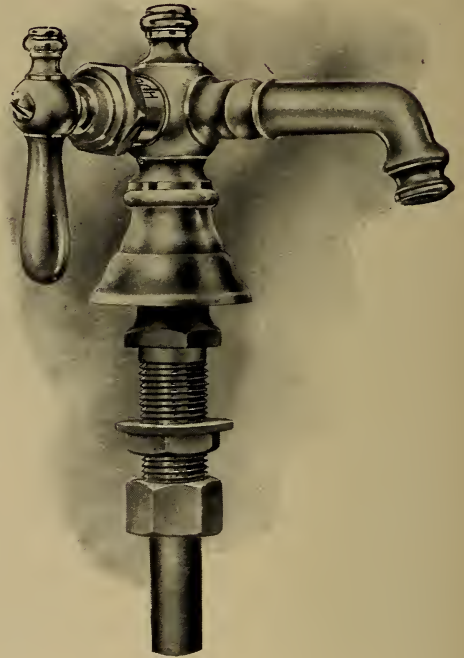

1171-C.

Nickel-Plated "Torrance" Pattern Fuller Basin Cock, with China Handle and Index.

Nickel-Plated "Monarch" Pattern Fuller Basin Cock.

Code.....	Pidange
Each.....	\$3.00
Weight each, lbs.....	1¾

Code.....	Piddocks	Piddule
Number.....	0-M	1-M
Each.....	\$1.50	1.50
Weight each, lbs.....	1½/16	1¾

Four in a box.

Six in a box.

Sent in pairs of Right and Left Hand unless otherwise ordered.

The Coupling Nuts and Inlets on above Basin Cocks are bored out to permit of making slip joint connection with ½-inch O. D. Nickel-Plated Tubing for Supply Pipes.

In Orders and Specifications give Plate Numbers.

FULLER BASIN COCKS.

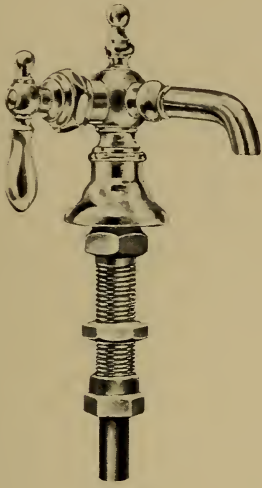

1172-C.

Nickel-Plated Fuller Basin Cock.

Code	Piecard
Number	0
Each	\$1.10
Weight per dozen, lbs.....	17½

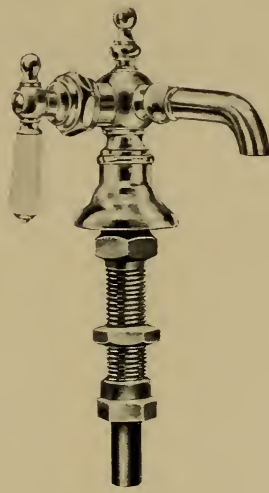

†1173-C.

Nickel-Plated Fuller Basin Cock with China Handle.

Code.....	Piecases
Number.....	0-C
Each.....	\$1.55
Weight per dozen, lbs.....	17

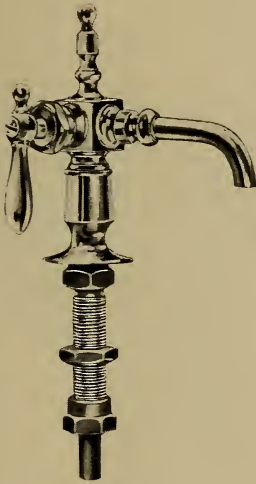

1174-C.

Nickel-Plated Fuller Basin Cock.

Code.....	Piechisi
Number	1
Each	\$1.10
Weight per dozen, lbs.....	20½

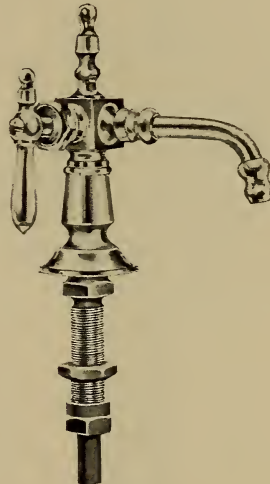

1175-C.

Nickel-Plated Fuller Basin Cock.

Code.....	Pieceless
Number	2
Each	\$1.25
Weight per dozen, lbs.....	21½

All on this page packed six in a box.

Sent in pairs of Right and Left Hand unless otherwise ordered.

The Coupling Nuts and Inlets on above Basin Cocks are bored out to permit of making slip joint connection with ½-inch O. D. Nickel-Plated Tubing for Supply Pipes.

† Carried in San Francisco only.

In Orders and Specifications give Plate Numbers.

FULLER BASIN COCKS.

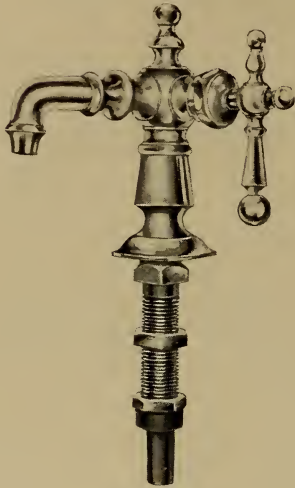

1176-C.

Nickel-Plated Fuller Basin Cock.

Code.....	Piedade
Number.....	3
Each.....	\$1.50]
Weight per dozen, lbs.....	22

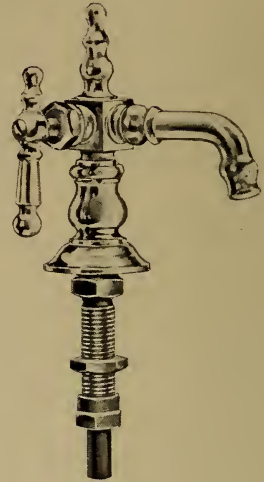

† 1177-C.

Nickel-Plated Fuller Basin Cock.

Code.....	Piedino
Number.....	4
Each.....	\$1.75
Weight per dozen, lbs.....	26



† 1178-C.

Nickel-Plated Fuller Basin Cock.

Code.....	Piedness
Number.....	5
Each.....	\$2.20
Weight per dozen, lbs.....	1 ⁵ / ₁₆



† 1179-C.

Nickel-Plated Fuller Basin Cock, with China Handle and Index.

Code.....	Piedoso
Number.....	5-C
Each.....	\$3.00
Weight per dozen, lbs.....	1 ⁵ / ₁₆

All on this page packed six in a box.

Sent in pairs of Right and Left Hand unless otherwise ordered.

The Coupling Nuts and Inlets on above Basin Cocks are bored out to permit of making slip joint connection with 1/2-inch O. D. Nickel-Plated Tubing for Supply Pipes.

† Carried in San Francisco only.

In Orders and Specifications give Plate Numbers.

FULLER BASIN COCKS.

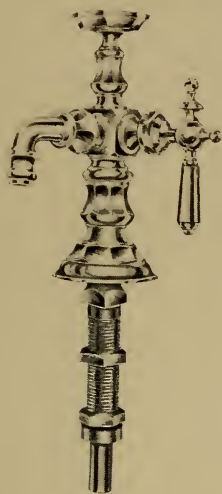

† 1180-C.

Nickel-Plated Fuller Basin Cock,
with Jewel Cup.

Code.....	Piedrotto
Number.....	6
Each.....	\$3.75
Weight per dozen, lbs.....	29

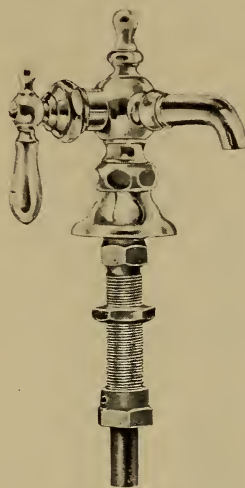

1181-C.

Nickel-Plated Fuller Basin Cock,
with Union.

Code.....	Piegatore
Number.....	8
Each.....	\$2.25
Weight per dozen, lbs.....	21

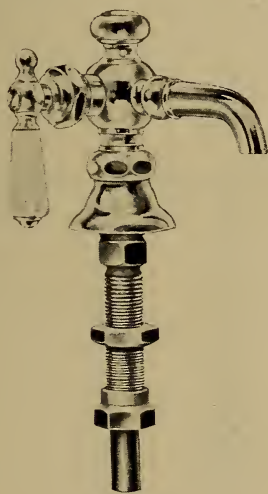

† 1182-C.

Nickel-Plated Fuller Basin Cock with Union,
China Handle and Index.

Code.....	Piegatura
Number.....	8-C
Each.....	\$3.20
Weight per dozen, lbs.....	21

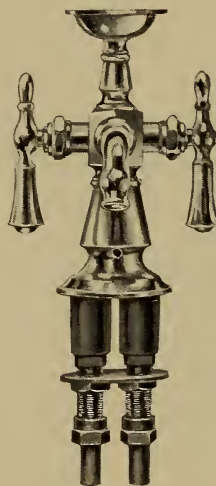

† 1183-C.

Nickel-Plated Round Pattern Double Fuller
Basin Cock, with Jewel Cup.

Code.....	Pielago
Each.....	\$8.75
Weight each, lbs.....	8½

Sent in pairs of Right and Left Hand unless otherwise ordered.

The Coupling Nuts and Inlets on above Basin Cocks are bored out to permit of making slip joint connection with ½-inch O. D. Nickel-Plated Tubing for Supply Pipes.

† Carried in San Francisco only.

In Orders and Specifications give Plate Numbers.

FULLER DOUBLE SHAMPOO COCK.

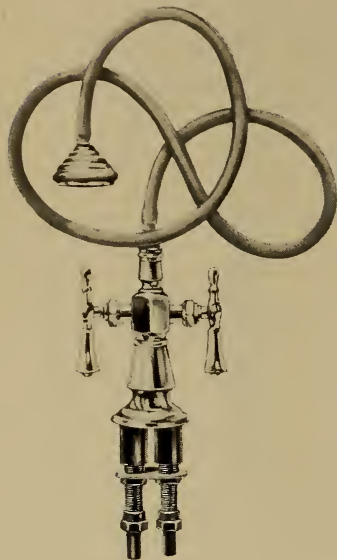

† 1188-C.

Nickel-Plated Fuller Double Shampoo Cock and Sprinkler, without Rubber Tube.

Code.....	Pienotto
Each.....	\$8.75
Weight each, lbs.....	4

One in a box.

SWING BASIN COCKS.

GROUND KEY.

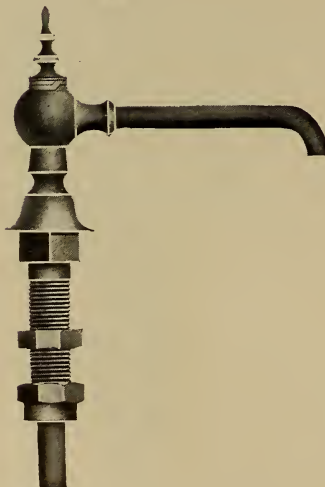

† 1190-C.

Nickel-Plated Swing Basin Cock.

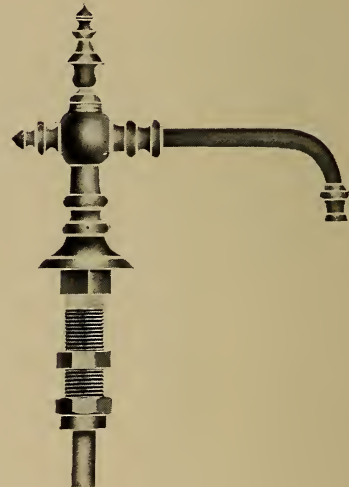

† 1191-C.

Nickel-Plated Swing Basin Cock.

Code.....	Pientibus
Number.....	1
Each.....	\$3.55
Weight per dozen, lbs.....	15

Code.....	Piepbock
Number.....	4
Each.....	\$4.70
Weight per dozen, lbs.....	16

One dozen in a box.

† Carried in San Francisco only.

In Orders and Specifications give Plate Numbers.

COMPRESSION BASIN COCKS.



1192-C.

Nickel-Plated Compression Basin Cock with Tee Handle.

Code.....	Piepente
Number.....	0
Each.....	\$0.70
Weight per dozen, lbs.....	13

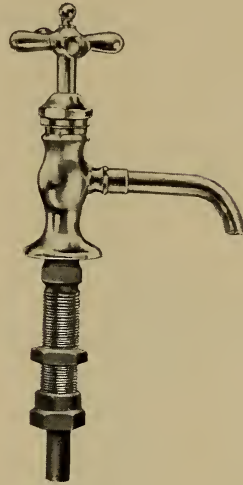

1193-C.

Nickel-Plated Compression Basin Cock with Cross Handle.

Code.....	Piepfig
Number.....	0-X
Each.....	\$0.75
Weight per dozen, lbs.....	13½

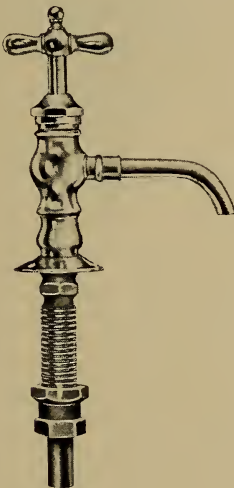

†1194-C.

Nickel-Plated Compression Basin Cock with Tee Handle.

Code.....	Piephahn
Number.....	1
Each.....	\$0.75
Weight per dozen, lbs.....	14



†1195-C.

Nickel-Plated Compression Basin Cock with Large Tube and Cross Handle.

Code.....	Piertagos
Number.....	4-X
Each.....	\$1.25
Weight per dozen, lbs.....	16½

All on this page packed twelve in a box.

† Carried in San Francisco only.

In Orders and Specifications give Plate Numbers.

COMPRESSION BASIN COCKS.

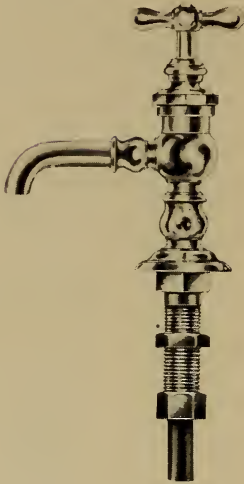

† 1196-C.

Nickel-Plated Compression Basin Cock with Large Tube, Cross Handle and Stuffing Box.

Code.....	Pietanza
Number.....	4½-X
Each.....	\$1.50
Weight per dozen, lbs.....	16



† 1198-C.

Nickel-Plated "Monarch" Pattern Compression Basin Cock, with Cross Handle.

Code.....	Pietanza
Number.....	1-M
Each.....	\$1.00
Weight per dozen, lbs.....	15

Six in a box.

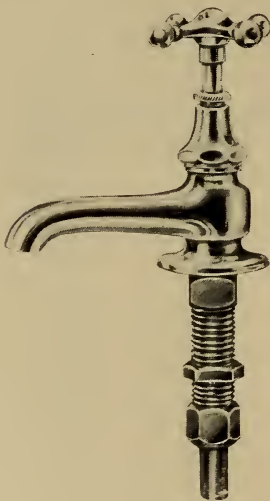

† 1197-C.

Nickel-Plated Low Pattern Compression Basin Cock with China Index.

Code.....	Pietanza
Number.....	7
Each.....	\$1.50
Weight per dozen, lbs.....

Six in a box.

† Carried in San Francisco only.

The Coupling Nuts and Inlets on Basin Cocks shown on this page are bored out to permit of making slip joint connection with ½-inch O. D. Nickel-Plated Tubing for Supply Pipes.

In Orders and Specifications give Plate Numbers.

SELF-CLOSING BASIN COCKS.

BROUGHTON.



† 1200-C.

Nickel-Plated Improved Broughton Self-Closing Basin Cock.

Code.....	Pietiner	Pietiniez
Style ...	Brass Nickel-Plated	Solid Silver Metal
Each.....	\$4.00	6.00
Wgt. per dz., lbs..	32	35
	Two in a box.	

The Broughton Self-Closing Work has been in use for several years. Many of the largest hotels and public buildings in the United States are equipped with these goods.

They have the merits of *Great Strength, Durability and Finest Workmanship.*

† Carried in San Francisco only.

THATCHER.



† 1201-C.

Nickel-Plated Thatcher Pattern Self-Closing Basin Cock with China Handle.

Code.....	Pietinons
Each.....	\$3.50
Weight per dozen, lbs.....	25
	Six in a box.

Sent in pairs of Right and Left Hand, unless otherwise ordered.

In Orders and Specifications give Plate Numbers.

SELF-CLOSING BASIN COCKS.



†1202-C.

Nickel-Plated "Telegraph" Self-Closing Basin
Cock with Large Tube.

Code.....	Pietrella
Number.....	0
Each.....	\$1.70
Weight per dozen, lbs.....	12



†1203-C.

Nickel-Plated "Doherty" Self-Closing Basin
Cock.

Code.....	Pietrolina
Number.....	2
Each.....	\$2.25
Weight per dozen, lbs.....	22



†1204-C.

Nickel-Plated "Moore's" Self-Closing Basin
Cock.

Code.....	Pietruzza
Each.....	\$3.00
Weight per dozen, lbs.....	21

† Carried in San Francisco only.

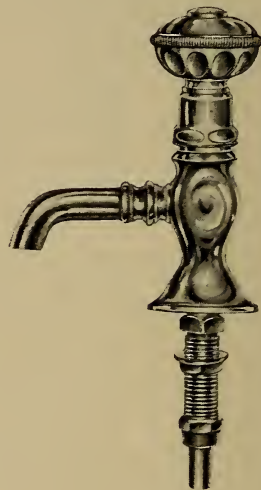

†1205-C.

Nickel-Plated "Milwaukee" Self-Closing Basin
Cock with Crown Handle and China Index.

Code.....	Pieux
Each.....	\$2.75
Weight per dozen, lbs.....	25

In Orders and Specifications give Plate Numbers.

PANTRY COCKS.

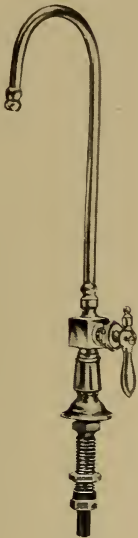

1206-C.

Nickel-Plated Fuller Pantry Cock.

Code.....	Pievambo	Pievarlo
Numbers ..	1	† 2
Each.....	\$2.00	2.35
Weight per dozen, lbs.....	22½	22

Two in a box.

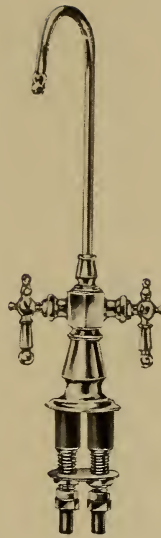

† **1207-C.**

Nickel-Plated Double Fuller Pantry Cock.

Code.....	Piezzo
Number.....	8
Each.....	\$8.15
Weight each, lbs.....	3¾

One in a package.

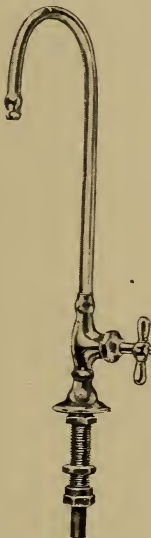

1208-C.

Nickel-Plated Compression Pantry Cock.

Code.....	Piezometer
Number.....	1
Each.....	\$2.00
Weight per dozen, lbs.....	16½

Two in a package.

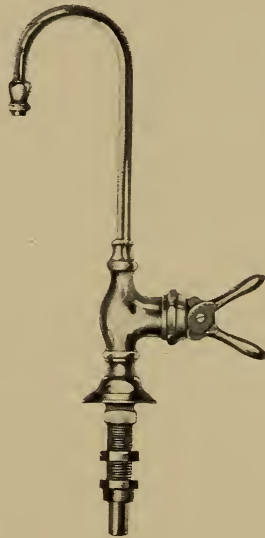

† **1209-C.**

Nickel-Plated Doherty Self-Closing Pantry Cock.

Code.....	Piezonote
Each.....	\$3.00
Weight per dozen, lbs.....	24

One in a package.

† Carried in San Francisco only.

In Orders and Specifications give Plate Numbers.

LAVATORY SUPPLY PIPES.

BRASS NICKEL-PLATED.

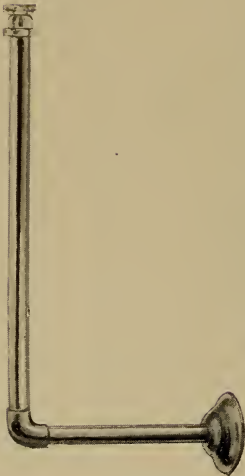

1210-C.

Nickel-Plated Lavatory Wall Supply Pipe. Iron Pipe Size Brass Tubing.

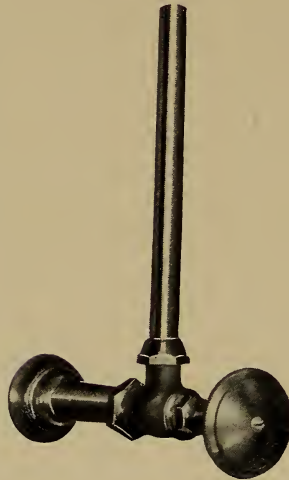

1211-C.

Nickel-Plated Lavatory Wall Supply Pipe with Wheel Handle Valve.

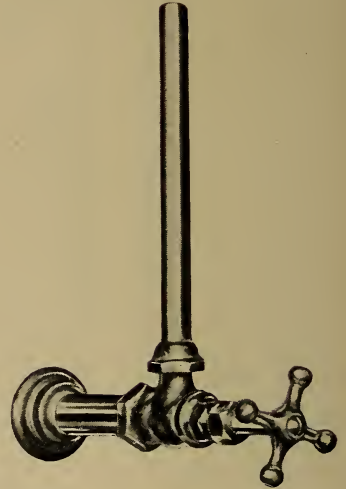

1212-C.

Nickel-Plated Lavatory Wall Supply Pipe with Cross Handle Valve.

1210-C.

3/8-inch Iron Pipe Size, with Slip Joint to take Tail Piece on Basin Cock.

Code	Pifferato
Number.....	3
Each.....	\$1.00
Weight each, lbs.....	3/4

1211-C and 1212-C.

3/8-inch or 1/2-inch Iron Pipe Size Connection at Wall with 1/2-inch O. D. Nickel-Plated Flexible Tubing that forms Slip Joint with Basin Cock.

	Wheel Handle.		Cross Handle.	
	Pifferello	Piffero	Pifaran	Pifarias
Code.....	4-W 3/8-inch	4-W 1/2-inch	4-C 3/8-inch	4-C 1/2-inch
Number.....				
Each.....	\$1.50	1.50	1.50	1.50
Weight each, lbs.....	3/4	1	3/4	1

For Supply Valves only, see pages 102 and 103.

Wheel Handle Supply Valves with Plumber's name on wheel can be furnished. Prices quoted upon application.

In Orders and Specifications give Plate Numbers and Sizes.

LAVATORY SUPPLY PIPES.

MADE FROM IRON PIPE SIZE BRASS TUBING.



1216-C.

Nickel-Plated Lavatory Floor Supply Pipe.
 3/8-inch Iron Pipe Size with Slip Joint to take
 Tail Piece on Basin Cock.

Code.....	Pigaca
Number.....	1
Length, inches.....	28
Each.....	\$1.00
Weight each, lbs.....	1 1/2



1217-C.

Nickel-Plated Floor Supply Pipe with Wheel
 Handle Stop. 3/8-inch Iron Pipe Size, with Slip
 Joint to take Tail Piece on Basin Cock.

Code.....	Pigamon
Number.....	2
Length, inches.....	28
Each.....	\$2.00
Weight each, lbs.....	1 1/2

Two in a package.

In Orders and Specifications give Plate Numbers.

“MENLO” LAVATORY WASTE.

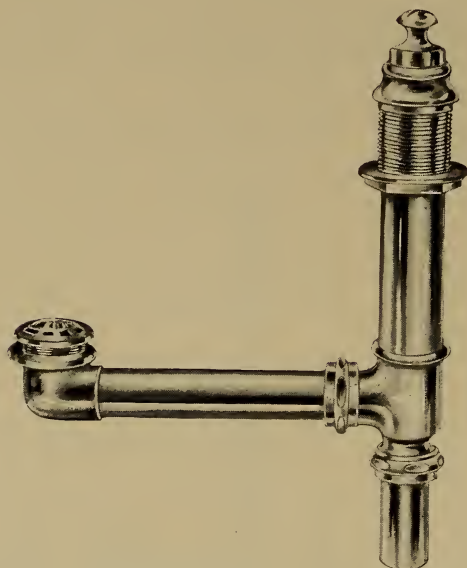

1220-C.

Nickel-Plated “Menlo” Lavatory Waste.

Code.....	Pigeonry	Piggeries
Style.....	Nickel-Plated	Nickel-Plated with China Index
Each.....	\$4.00	4.50
Weight each, lbs.....	3 $\frac{7}{8}$	4

One in a box.

The “Menlo” Waste may be used with any of our Traps.



1221-C.

STRAIGHT LAVATORY WASTE.

BRASS NICKEL-PLATED.

To the Floor, with Rubber Stopper.

Code.....	Pigiarle
Size, inches.....	1 $\frac{1}{4}$
Length over all, inches.....	25
Each.....	\$1.50
Weight each, lbs.....	1 $\frac{3}{4}$

In Orders and Specifications give Plate Numbers.

ELLIPTICAL ADJUSTABLE LAVATORY TRAPS.

CAST BRASS, POLISHED AND NICKEL-PLATED.



† 1224-C.

Nickel-Plated Elliptical Trap to the Floor.

Code.....	Pigliando	Pigliassi
Size, inches.....	1¼	1½
Length over all, in...	25	25
Each	\$3.25	4.00
Weight each, lbs.	4	4¾

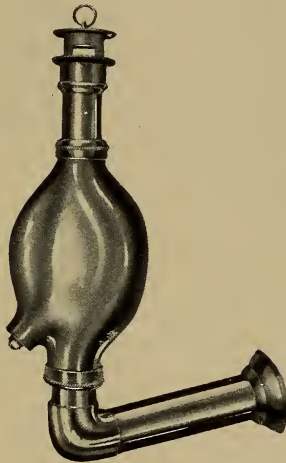

† 1225-C.

Nickel-Plated Elliptical Trap to the Wall.

Code.....	Piglibant	Piglicase
Size, inches.....	1¼	1½
Each	\$3.25	4.00
Weight each, lbs.	4¾	5

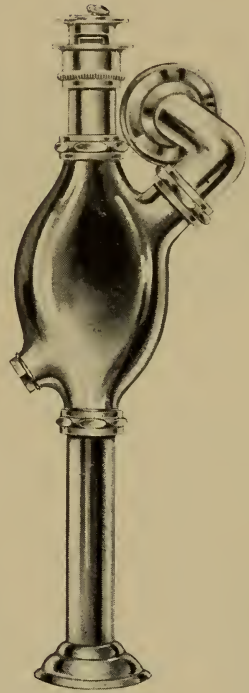

† 1226-C.

Nickel-Plated Elliptical Trap to the Floor, with Vent.

Code.....	Pigmeas	Pigmost
Size, inches.....	1¼	1½
Length over all, in...	25	25
Each	\$4.00	4.75
Weight each, lbs.	4¾	5¼

One in a box.

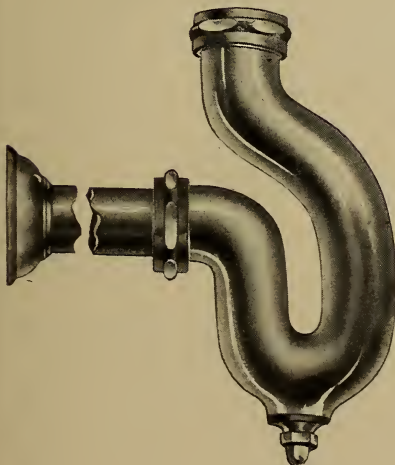

1228-C.

† Carried in San Francisco only.

BAG TRAP.

CAST BRASS, POLISHED AND NICKEL-PLATED.

This Trap has Slip Joint Outlet Tail Piece and can be used with Basin Plugs having 1¼-inch O. D. Tail Pieces.

Code.....	Pigmot	Pigmovent
Size, inches.....	† 1¼	1½
Each.....	\$2.50	2.75
Weight each, lbs.....	2	3½

One in a box.

In Orders and Specifications give Plate Numbers and Sizes.

PLAIN LAVATORY TRAPS.

CAST BRASS POLISHED AND NICKEL-PLATED.

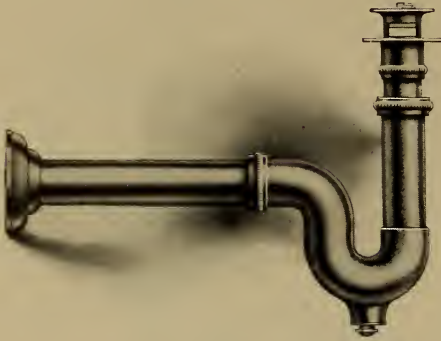

† 1230-C.

Plain Nickel-Plated Lavatory P Trap.

Code.....	Pignatta	Pignattini	Pignerabis
Size, inches.....	1¼	1½	2
Each.....	\$3.00	3.75	7.50
Weight each, lbs..	2	2½	4½

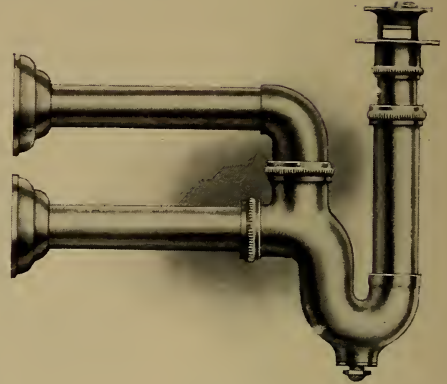

† 1231-C.

Plain Nickel-Plated Lavatory P Trap Vented.

Code.....	Pigneranda	Pigneratio
Size, inches.....	1½	2
Each.....	\$3.75	8.00
Weight each, lbs.....	4¼	8

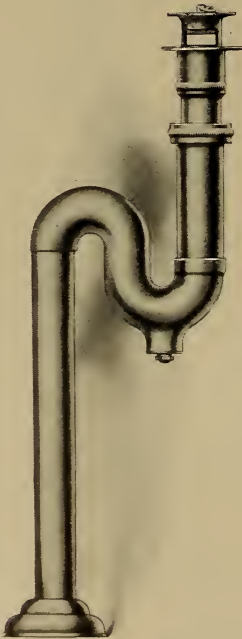

† 1232-C.

Plain Nickel-Plated Lavatory S Trap.

Code.....	Pignerator	Pigneravit	Pignerawl
Size, inches.....	1¼	1½	2
Each.....	\$3.25	4.00	7.50
Weight each, lbs..	2¾	3¼	6

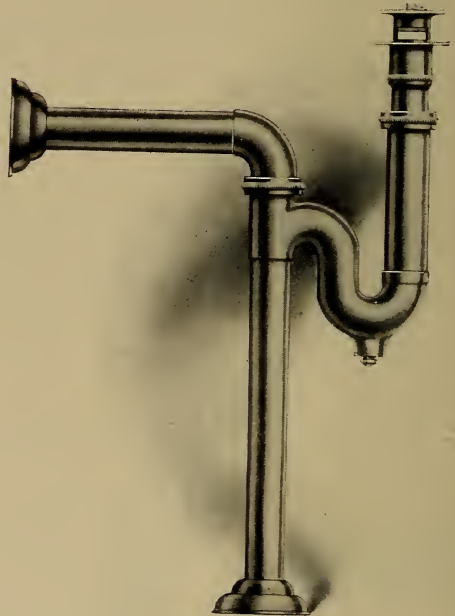

† 1233-C.

Plain Nickel-Plated Lavatory S Trap Vented.

Code.....	Pignerazot	Pignerazzi
Size, inches.....	1½	2
Each.....	\$4.50	8.50
Weight each, lbs.....	4½	8½

One in a box.

† Carried in San Francisco only.

In Orders and Specifications give Plate Numbers and Sizes.

H. M. & S. ADJUSTABLE LAVATORY TRAPS.

BRASS, POLISHED AND NICKEL-PLATED.

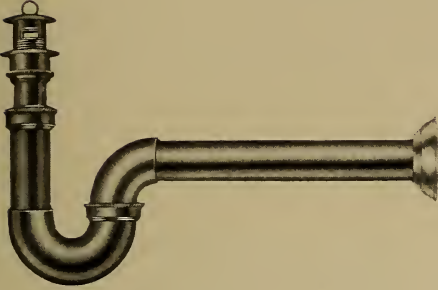

1235-C.

Adjustable Nickel-Plated Lavatory P Trap.

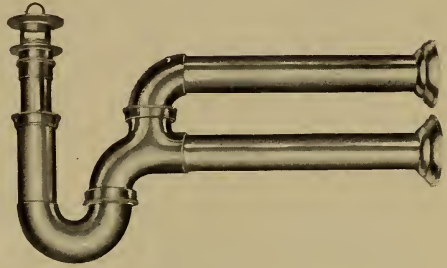

1236-C.

Adjustable Nickel-Plated Lavatory P Trap, Vented.

Code.....	Pigneres	Pignolato
Inches.....	1¼	1½
Each	\$2.00	2.25
Weight each, lbs.....	1¾	2¾

Code.....	Pignonne
Inches.....	1½
Each.....	\$2.75
Weight each, lbs.....	3¼

One in a box.



1237-C.

Adjustable Nickel-Plated Lavatory S Trap.

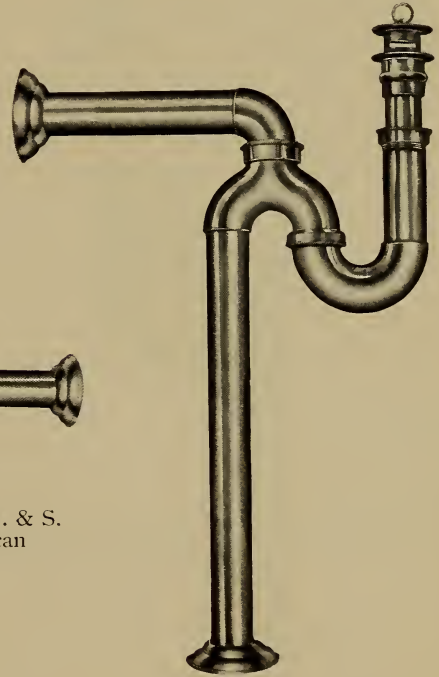

1238-C.

Adjustable Nickel-Plated Lavatory S Trap, Vented.

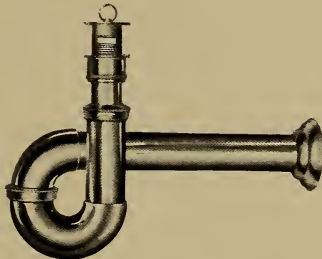

Cut shows how H. M. & S. Adjustable Trap can be used.

Code.....	Pignorada	Pignoratif
Inches.....	1¼	1½
Each.....	\$2.25	2.50
Weight each, lbs.....	2¾	3¼

Code.....	Pignuolo
Inches.....	1½
Each.....	\$3.00
Weight each, lbs.....	3¾

One in a box.

In Orders and Specifications give Plate Numbers and Sizes.

PLAIN SINK AND CONTINUOUS WASTE TRAPS.

CAST BRASS POLISHED AND NICKEL-PLATED.

These Traps can be used with Continuous Waste shown on Page 359, or they can be applied to Kitchen Sinks by using Sink Connection, 1261-C.



† 1240-C.

Plain Nickel-Plated Sink P Trap.

Code.....	Pignuomic	Pignuoppe	Pignuoram
Size, inches.....	1¼	1½	2
Each.....	\$2.50	3.25	7.00
Weight each, lbs..	1¾	2	4

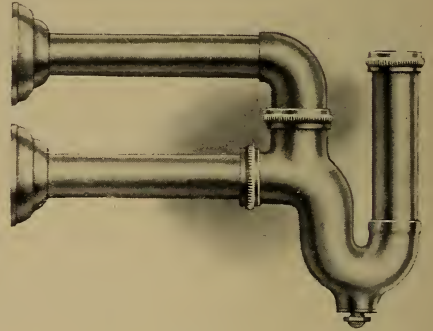

† 1241-C.

Plain Nickel-Plated Sink P Trap, Vented.

Code.....	Pignuosa	Pignuosit
Size, inches.....	1½	2
Each.....	\$3.75	8.00
Weight each, lbs.....	3¾	7½

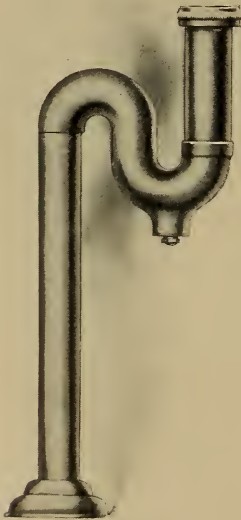

† 1242-C.

Plain Nickel-Plated Sink S Trap.

Code.....	Pignuppa	Pignurade	Pignureem
Size, inches.....	1¼	1½	2
Each.....	\$2.75	3.50	7.00
Weight each, lbs...	2¼	2¾	5½

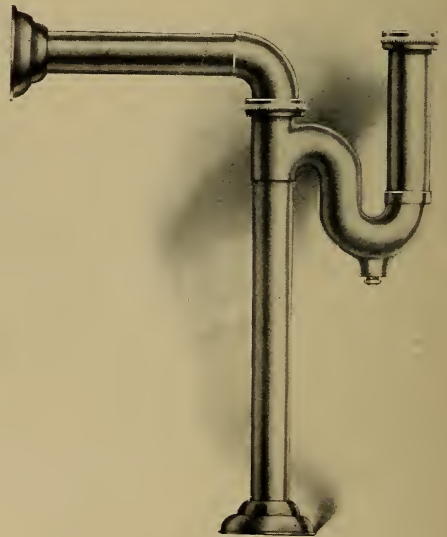

† 1243-C.

Plain Nickel-Plated Sink S Trap, Vented.

Code.....	Pignuricht	Pignurome
Size, inches.....	1½	2
Each.....	\$4.00	8.00
Weight each, lbs.....	4	8

One in a box.

† Carried in San Francisco only.

In Orders and Specifications Give Plate Numbers and Sizes.

H. M. & S. ADJUSTABLE SINK TRAPS.

POLISHED BRASS. NICKEL-PLATED.



1246-C.

Adjustable Nickel-Plated Sink P Trap.

Code.....	Pignurosse	Pigoche
Size, inches.....	1¼	1½
Each.....	\$2.00	2.25
Weight each, lbs.....	1¾	2¾



1247-C.

Adjustable Nickel-Plated Sink S Trap.

Code.....	Pigodale	Pigolone
Size, inches.....	1¼	1½
Each.....	\$2.25	2.50
Weight each, lbs.....	2¾	3¾

The Cast Brass Collar on these Traps will fit the Coupling on all Cast Iron Sinks.

CONTINUOUS WASTE PIPES.

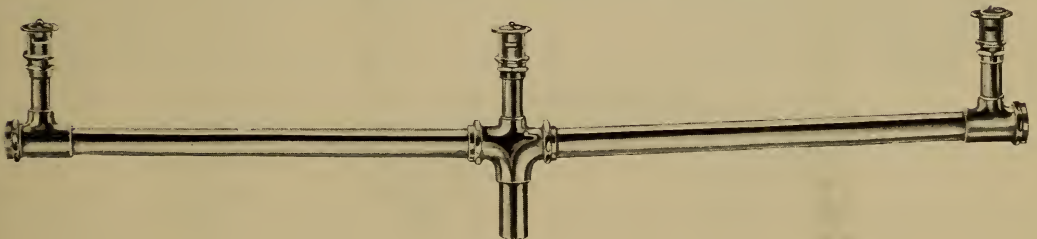

1248-C.

Nickel-Plated Continuous Waste Pipes for Sectional Lavatories, Laundry Trays, Sinks, etc. Can be furnished with outlet at either end if so desired.

Code.....	Pigotite	Pigozzo	Pigraberis
Size, inches	1¼	1½	2
Per Section.....	\$2.00	2.25	3.00
Weight per section, lbs.....

Continuous Waste Pipes can be furnished in any style or finish desired. Prices upon application.

In Orders and Specifications give Plate Numbers and Sizes.

DIAMOND UNIVERSAL SINK TRAPS.

CLOSE GRAIN GREY CAST IRON. PAINTED RED. WITH BRASS TRAP SCREW.



† 1250-C.

With Flange.

Inlet Fits Sink Coupling. Outlet Threaded for Iron Pipe.

Code.....	Pig	rantes	Pig	bunt
Inches.....	1¼		1½	
Each.....	\$0.75		1.00	
Weight each, lbs.	3¼		4	

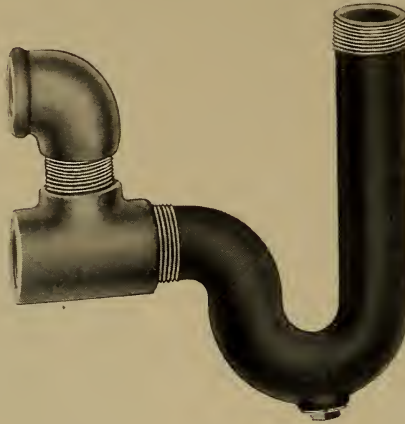

† 1251-C.

Showing how Trap may be vented by using ordinary pipe fittings.

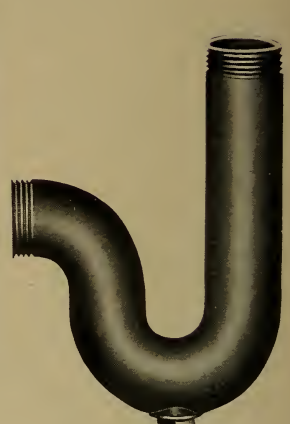

† 1252-C.

Threaded.

Outlet and Inlet Threaded for Iron Pipe.

Code.....	Pig	remus	Pig	resco
Inches.....	1¼		1½	
Each.....	\$0.75		1.00	
Weight each, lbs.,	3½		3¾	

The **Diamond Universal Cast Iron Traps** are designed to meet different requirements and to be as near **universal** as possible. They have all the good qualities of the brass trap, except in appearance. They are durable, clean and very neat looking. When the brass trap screw is removed, a sink collar will pass over the body of Trap. All threads are for 1¼ or 1½ inch standard iron pipe fittings.

By the use of iron pipe fitting, a ¼ **S** or **Full S** Trap can be made. To vent any of the above styles, use Tees, taking vent out of top opening in Tee. See 1251-C.

OHIO SINK TRAPS.

ROUGH BRASS, NICKEL-PLATED.

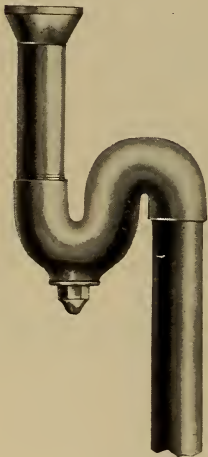

† 1255-C.

Full S Trap.

Code.....	Pig	ritor
Inches.....	1½	
Center to center, inches	4½	
Length over all, "	24	
Each.....	\$2.00	
Weight each, lbs.....	2¾	

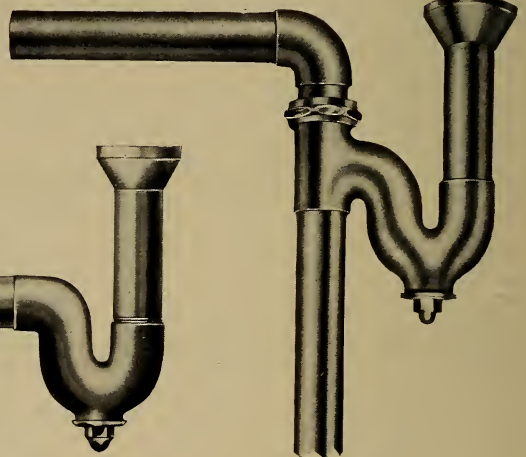

† 1257-C.

Full S Trap Vented.

Code.....	Pig	sties
Inches.....	1½	
Length over all, inches..	24	
Center to center, inches,	4½	
Each.....	\$2.50	
Weight each, lbs... ..	3½	

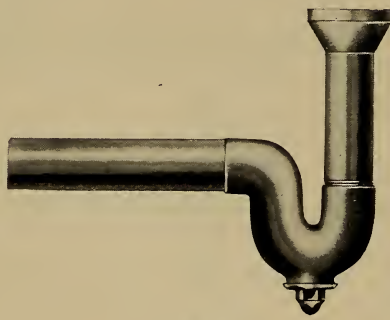

† 1256-C.

½ S or P Traps.

Code.....	Pig	rolier
Inches.....	1½	
Center to center of out-		
let, inches.....	15½	
Each.....	\$2.00	
Weight each, pounds...	2¼	

These Traps are made of brass and nickel-plated, but not polished. They are fitted with a connection to go into the collar of cast iron sink. They are much stronger than lead traps and cost very little more.

† Carried in San Francisco only.

In Orders and Specifications give Plate Numbers and Sizes.

LAVATORY PLUGS.

SINK CONNECTIONS.

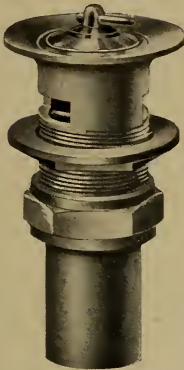

1260-C.

Brass with Rubber Stoppers. Finished Nickel-Plated Top Flange.

Code	Pigstem
Each.....	\$0.40
Weight each, lbs.....	$\frac{17}{16}$



1261-C.

Brass Finished and Nickel-Plated for Nickel-Plated Sink Traps. $1\frac{1}{4}$ -inch O. D. Tail Pieces.

Code	Pigsteps
Each	\$0.30
Weight each, lbs.....	$\frac{5}{8}$

SLIP JOINT LAVATORY PLUGS.

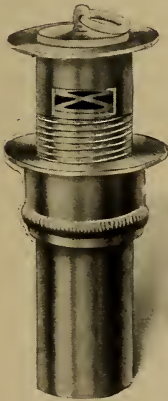

1262-C.

Slip Joint Lavatory Plug. Brass, Nickel-Plated all over. With Rubber Stopper. $1\frac{1}{4}$ -inch O. D. Tail Pieces, 2 inches long.

Code	Pigsticker
Each.....	\$0.40
Weight each, lbs.....	$\frac{3}{8}$

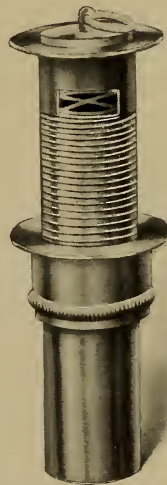

1263-C.

Extra Long Slip Joint Lavatory Plug. Nickel-Plated all over. With Rubber Stopper. $1\frac{1}{4}$ -inch O. D. Tail Pieces, 2 inches long.

Code.....	Pigstorm
Each.....	\$0.50
Weight each, lbs.....	$\frac{1}{2}$

We can furnish Slip Joint Plugs with $1\frac{1}{4}$ -inch O. D. Tail Pieces, $4\frac{3}{4}$ inches long, Nickel-Plated all over when desired.

In Orders and Specifications give Plate Numbers and Sizes.

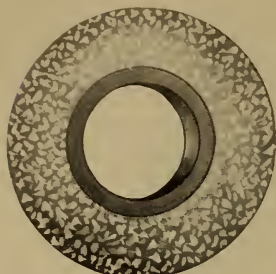

1270-C.

BASIN COCK WASHERS.

GALVANIZED.

To be used between Slab and Lock Nut on Basin Cock.

Code.....	Piguit
Per dozen	\$2.25
Weight per dozen, lbs.....	10

LAVATORY, BATH OR SINK GASKETS.



1272-C.

1-inch Rubber Lavatory or Basin Gasket.

Code.....	Pigweed
Per dozen	\$0.50
Weight per dozen, lbs.....	3/8



1273-C.

1 1/2-inch Rubber Bath Tub or Sink Gasket.

Code.....	Pigwigglin
Per dozen	\$1.25
Weight per dozen, lbs.....	3/4

SLIP JOINT RINGS OR WASHERS.

RUBBER.



1275-C.

Feather Edge, for Supply Valves.

Code	Pihlite
Size, inch.....	1/2
Per dozen	\$0.30
Wt. per gro., lbs...	3/8



1276-C.

Straight for Supply Valves.

Code.....	Pihuela
Size, inch.....	1/2
Per dozen	\$0.25
Wt. per gro., lbs...	3/8



1280-C.

For Traps or Waste Pipes.

Code.....	Pikarden	Pikelin
Size, inches.....	1 1/4 x 1 1/2 x 3/16	1 1/2 x 1 3/4 x 3/16
Per dozen	\$0.50	0.50
Wt. per gro., lbs...	1	1

LAVATORY AND BATH TUB WASTE WASHERS.

RUBBER.

Code.....	Pikeman	Piketten
Numbers	519	1534
Inches	1	1 1/4
Each.....	\$0.10	0.15
Weight per dozen, lbs.....	1/8	5/16



1282-C.

In Orders and Specifications give Plate Numbers.

LAVATORY WALL HANGERS AND CONCEALED BRACKETS.



Back of One-Piece Lavatory, showing part of Concealed Wall Hanger.

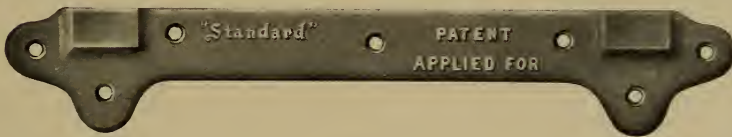

1285-C.

Concealed Wall Hanger for Lavatories. Plain Cast Iron.

Code.....	Pilatorum	Pilantium	Pilaremus	Pilaribus
Size, inches.....	20	24	27	30
Each.....	\$1.00	1.50	2.00	2.50
Weight each, lbs.....



1287-C.

Showing Application of Secret Bracket.

Lavatories with Secret Brackets are made so that a board can be used behind the back if desired, thus obviating any trouble in finding studding to which brackets can be fastened.

In Orders and Specifications give Plate Numbers.

LAVATORY LEGS.

FOR PORCELAIN ENAMELED LAVATORIES.

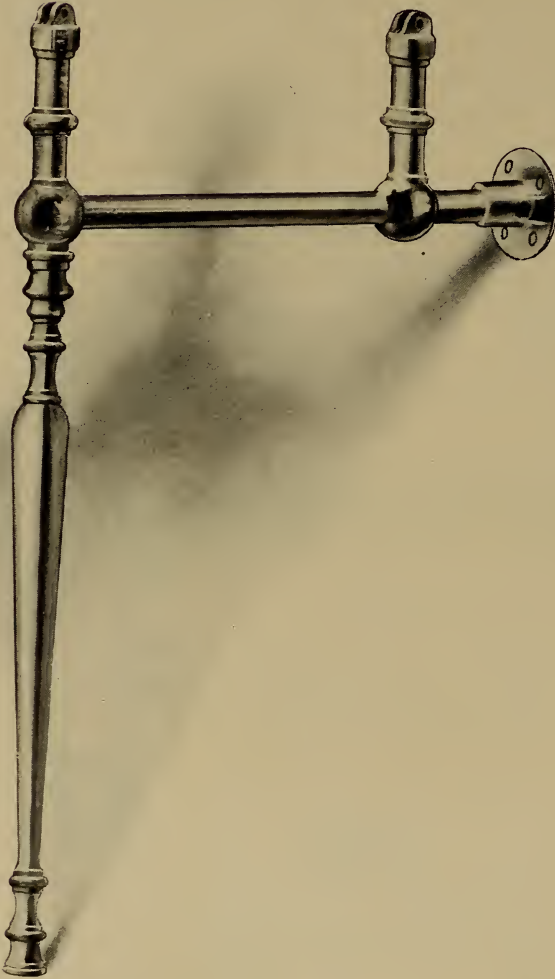

† 1290-C.



† 1291-C.

Nickel-Plated Brass Lavatory Leg and Frame with Round Tapered Cast Post and Cast Foot.

Code.....	Pilasses
Per pair.....	\$9.00
Weight per pair, lbs.....

For use on 1070-C and 1072-C Lavatories.

Nickel-Plated Brass Lavatory Leg with Hexagon Cast Post and Cast Taper Foot.

Code.....	Pilaster
Per pair.....	\$7.50
Weight per pair, lbs.....

For use with one-piece Lavatories, supported on Concealed Wall Hangers.

The above Lavatory Legs are beautifully finished and are intended for use on Porcelain Enameled Lavatories only.

† Carried in San Francisco only.

In Orders and Specifications give Plate Numbers.

LAVATORY LEGS.

FOR MARBLE LAVATORIES. CAST BRASS, POLISHED AND NICKEL-PLATED.

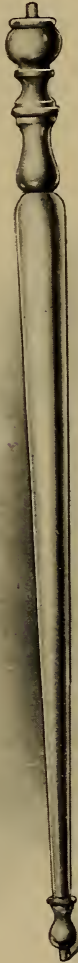

† 1292-C.

Nickel-Plated Straight Lavatory Leg, with Doweled Top and Bottom.

Code.....	Pilastrone
Per pair.....	\$8.75
Weight per pair, lbs.....	...

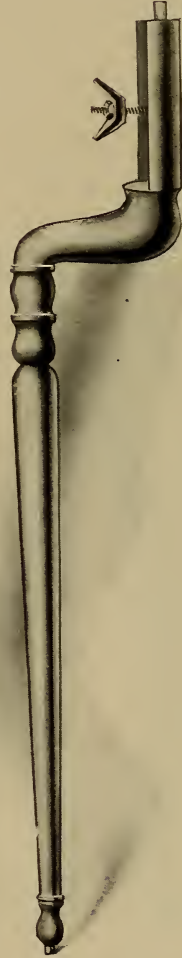

† 1293-C.

Nickel-Plated Offset Lavatory Leg for 5-inch Aprons, with Doweled Top and Bottom and Apron Clamp.

Code.....	Pilatarum
Per pair.....	\$12.00
Weight per pair, lbs.....	...

† Carried in San Francisco only.

In Orders and Specifications give Plate Numbers.

LAVATORY LEGS.

FOR MARBLE LAVATORIES. BRASS, POLISHED AND NICKEL-PLATED.



† 1295-C.



† 1296-C.



† 1297-C.

Nickel-Plated Straight Plain
Tube Lavatory Leg with
Doweled Flanges on
Both Ends.

Nickel-Plated Straight Rope
Tube Lavatory Leg with
Claw Foot Base.

Nickel-Plated Offset Rope
Tube Lavatory Leg
with Claw Foot
Base.

Code..... Pilateros
Per pair..... \$1.75
Weight per pair, lbs.... ...

Code..... Pilatrix
Per pair..... \$2.50
Weight per pair, lbs.... ...

Code..... Pilatus
Per pair..... \$4.00
Weight per pair, lbs.... ...

† Carried in San Francisco only.

In Orders and Specifications give Plate Numbers.

LAVATORY LEGS.

FOR MARBLE LAVATORIES WITH APRONS. BRASS, POLISHED AND NICKEL-PLATED.



† 1298-C.

Nickel-Plated Offset Plain Tube Lavatory Leg
for 5-inch Aprons, with Claw Foot
Base and Apron Clamp.

Code.....	Pilchard
Per pair.....	\$4.00
Weight per pair, lbs

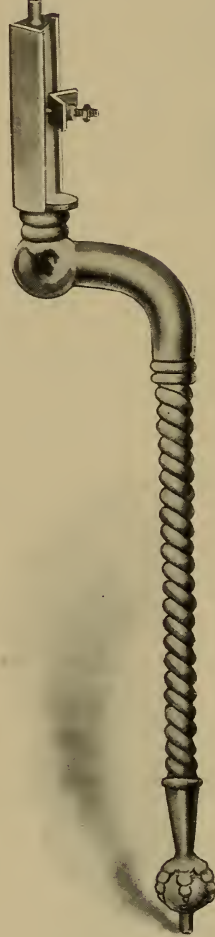

† 1299-C.

Nickel-Plated Offset Rope Tube Lavatory Leg
for 5-inch Aprons, with Claw Foot
Base and Apron Clamp.

Code.....	Pilcrow
Per pair.....	\$4.00
Weight per pair, lbs.....	...

† Carried in San Francisco only.

In Orders and Specifications give Plate Numbers.

APRON WALL BRACKETS OR SUPPORTS.

BRASS, NICKEL-PLATED.



1301-C.

Nickel-Plated Apron Wall Bracket for 5 inch Aprons, with Doweled Top and Screw Holes on either side.

Code.....	Pildash
Each.....	\$0.65
Weight each, lbs.	$\frac{3}{8}$

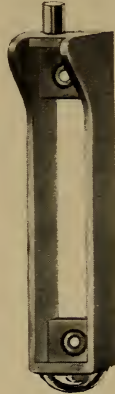

1302-C.

Nickel-Plated Apron Wall Bracket for 5 inch Aprons with Doweled Top and Screw Holes in Recess.

Code.....	Pildora
Each	\$0.50
Weight each, lbs.....	$\frac{5}{16}$



1303-C.

Nickel-Plated Apron Wall Bracket for 5 inch Aprons with Doweled Top and Set Screw. For Recess Lavatories.

Code.....	Pileoles	Pileolum
Style	Right	Left
Each	\$0.65	.65
Weight each, lbs.	$\frac{5}{16}$	$\frac{5}{16}$

Sent in Pairs of Right and Left unless otherwise ordered.

Twenty-four in a box.

LAVATORY BRACKETS.

NICKEL-PLATED BRASS BRACE WITH NICKEL-PLATED STEEL TOPS.



1306-C.

Plain Pattern.

Code.....	Pileopsis
Size, inches.....	16x18
Per pair.....	\$2.00
Weight per pair, lbs.....	$3\frac{3}{16}$



1307-C.

Rope Pattern.

Code.....	Pileront
Size, inches.....	16x18
Per pair.....	\$2.00
Weight per pair, lbs.....	$3\frac{1}{8}$

One pair in a package.

In Orders and Specifications give Plate Numbers.

STEEL LAVATORY BRACKETS.

NICKEL-PLATED AND POLISHED.



1310-C.

Nickel-Plated Steel Lavatory Bracket.

Code.....	Pileworm
Number.....	1618
Size, inches.....	16x18
Per pair	\$1.70
Weight per pair, lbs.....

Twelve pairs in a case.



1312-C.

Nickel-Plated Steel Lavatory Bracket.

Code.....	Pilfered
Number.....	7082
Size, inches.....	16x18
Per pair.....	\$1.70
Weight per pair, lbs.....

One pair in a package.

Above Brackets are made of heavy Cold Rolled Steel, which is Electro Copper-Plated, then Nickel-Plated.



1314-C.

LAVATORY BRACKETS.

HAMMOND DESIGN.

IRON PORCELAIN ENAMELED.

Code.....	Pilger	Pilgerede	Pilgerhut	Pilgerstab
Size, inches...	16	18	20	22
Per pair.....	\$1.50	2.00	2.50	3.00

BRASS NICKEL-PLATED.

Code.....	Pilgerwelt	Pilgerzug	Pilhagem	Pilharia
Size, inches...	16	18	20	22
Per pair.....	\$6.00	8.00	10.00	12.00

In Orders and Specifications give Plate Numbers.

LAVATORY BRACKETS.

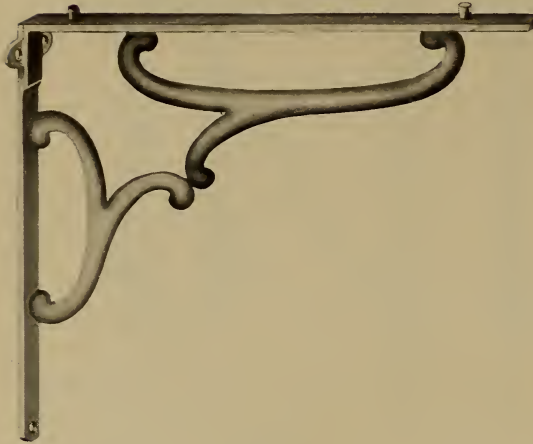

1316-C.

Nickel-Plated Brass Lavatory Bracket.

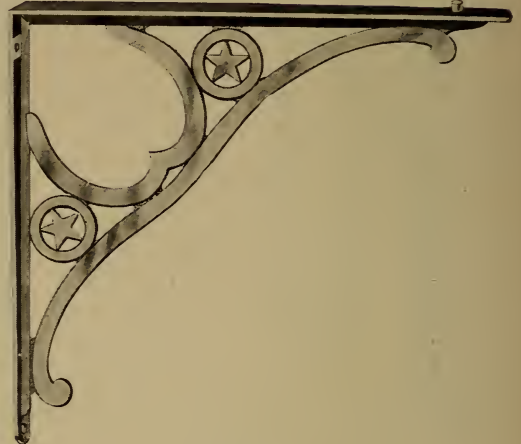

1318-C.

Nickel-Plated Cast Iron Lavatory Bracket.

Code.....	Pilidium
Number.....	8
Size, inches.....	16x18
Per pair.....	\$6.25
Weight per pair, lbs.....	...

Code.....	Pilidium
Number.....	54
Size, inches.....	16x18
Per pair.....	\$1.50
Weight per pair, lbs.....	...

SEAT AND TANK BRACKETS.



1320-C.

Nickel-Plated Pressed Steel.

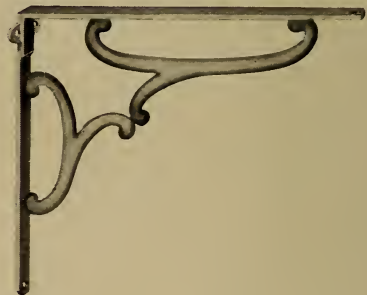

1321-C.

Nickel-Plated Brass.

Code.....	Piliforme	Pilipede	Pilipogon	Pilaffe
Size, inches.....	4x5	5x7	7x9	8x10
Per pair.....	\$0.30	.40	.70	.85
Weight per pair, lbs..

Code.....	Pillajes	Pillard	Pillarist	Pilleares
Size, inches.....	4x5	5x7	7x9	8x10
Per pair.....	\$1.15	1.40	1.95	2.40
Weight per pair, lbs..

In Orders and Specifications give Plate Numbers and Sizes.

SECTION 5.

SINKS, WASH TRAYS, SLOP HOPPERS, ETC.

SOLID PORCELAIN,

PORCELAIN ENAMELED,

PRESSED STEEL,

PLAIN CAST IRON

AND SUNDRIES.

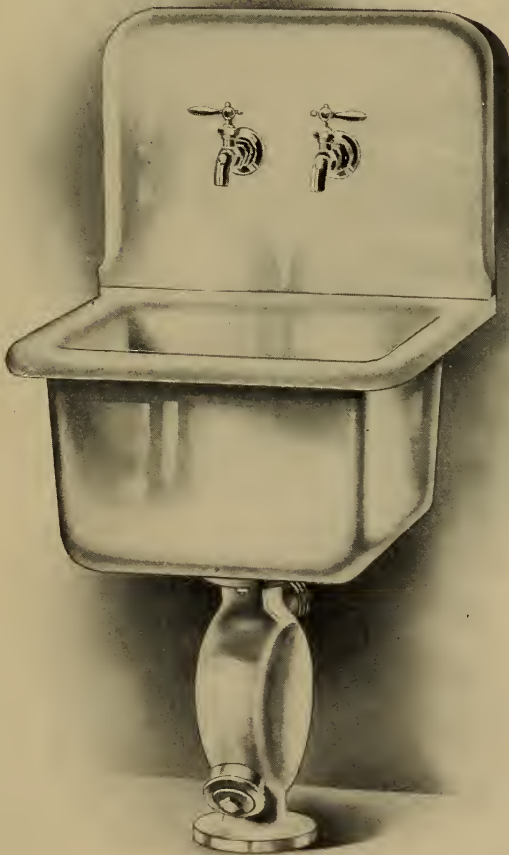

HOLBROOK, MERRILL & STETSON,
INCORPORATED.

SAN FRANCISCO, LOS ANGELES AND NEW YORK.

SINKS, WASH TRAYS, SLOP HOPPERS, ETC.

We are prepared to furnish these fixtures, with any extras pertaining to same, either in **Solid Porcelain, Porcelain Enameled Iron, Painted Iron, Enameled Steel** or **Painted Steel**.

Also any of the various styles of **Grease Traps, Cesspools**, etc., shown in the following section.

In ordering goods from this section by telegraph, it is only necessary to use the code word over or opposite the number or size of the article or fixture wanted, preceded by words from code in front of the book.

Example: Crofter six Pisenor with Piticos.

Translation: Ship by first steamer six enameled flat rim sinks, twenty by thirty, with shallow pattern backs.

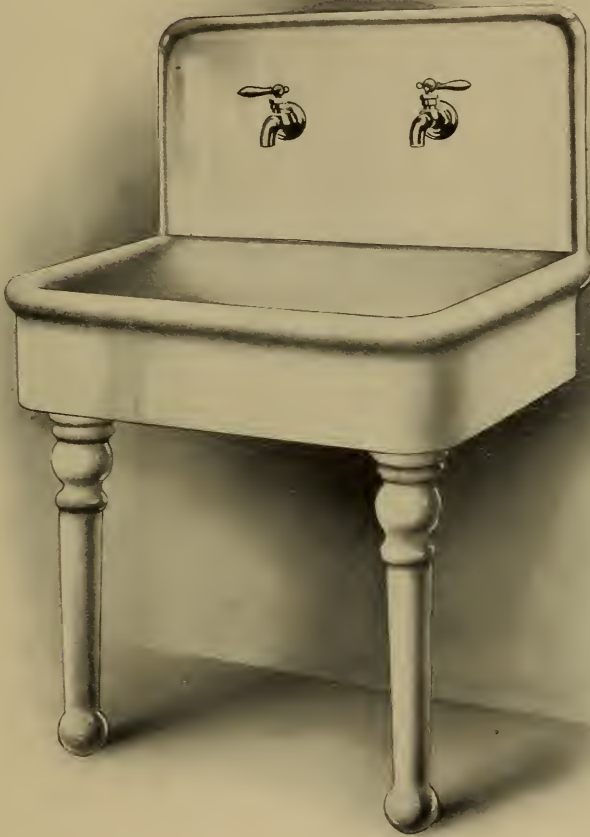
SOLID PORCELAIN ROLL RIM KITCHEN SINKS.**1400-C.**

Solid Porcelain Roll Rim Kitchen Sink, Glazed Pure White, with Solid Porcelain Back and Legs, with Iron Braces to Wall; Nickel-Plated Fuller Bibbs; Nickel-Plated Plug with Open Strainer.

Code.....	Pinacling	Pinnacolo	Pinnately	Pinnholz	Pinnigene
Size outside, inches.....	17x24	20x30	23x36	24x42	24x48
Depth inside, inches.....	6	7	7	7	7
Height of back, inches.....	15	15	15	18	18
Complete as described	\$34.50	42.00	47.00	56.00	65.00
Shipping weight, lbs.....	200	275	365	375	425
Without Porcelain Back, deduct.....	\$5.50	7.00	8.00	10.00	12.00

Without Porcelain Legs and Wall Braces, deduct \$12.00.

Without Fuller Bibbs and Flanges, deduct \$2.50.

For prices on Brass and Iron Legs and Plugs see page 374.

In Orders and Specifications give Plate Numbers and Sizes.

SOLID PORCELAIN KITCHEN SINKS.

ROLL RIM FRONT AND TWO ENDS.

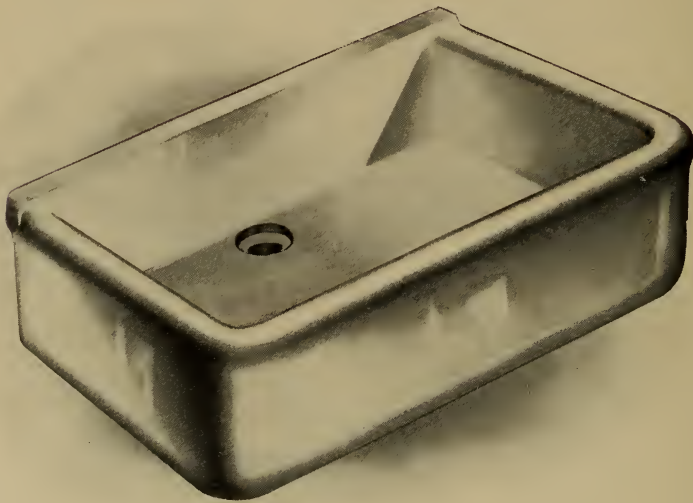

1402-C.

Can be set up with Marble or Porcelain Back or set into Tile. Sink can be supported by Brackets or Legs, according to requirements.

Code.....	Pinopile	Pinoraban	Pinques	Pinsard	Pinsbek
Size outside, inches	17x24	20x30	23x36	24x42	24x48
Depth, inches.....	6	7	7	7	7
Each.....	\$12.00	18.00	22.00	29.00	36.00
Shipping weight, lbs.....	115	175	235	340	390

Add to the above list for the following.

Code.....	Pinscher	Pinissem	Pinson	Pintado	Piutail
Solid Porcelain Back.....	\$5.50	7.00	8.00	10.00	12.00

Solid Porcelain Legs, complete with Iron Braces to Wall.....	Per pair,	\$12.00
Cast Brass Nickel-Plated Legs, complete with Braces to Wall.....	“	10.00
Galvanized Iron Legs, complete with Braces to Wall.....	“	5.00
White Enamel Painted Iron Legs, complete with Braces to Wall.....	“	5.50
Bronzed Iron Legs, complete with Braces to Wall.....	“	4.50
Nickel-Plated Brass Plug and Coupling with Rubber Stopper.....	Each,	2.50
Nickel-Plated Brass Plug and Coupling with Strainer.....	“	2.50

In Orders and Specifications give Plate Numbers and Sizes.

SOLID PORCELAIN PANTRY SINKS.**1404-C.**

Solid Porcelain Roll Rim Pantry Sink, with Double Drain Shelves and Back. Glazed Pure White; Nickel-Plated Fuller Bibbs; Nickel-Plated Plug and Coupling with Rubber Stopper; Nickel-Plated Legs and Wall Braces.

Code.....	Pintoja
Length over all, inches.....	48
Depth, inches.....	6
Width over all, inches.....	18
Length of drain shelves, each, inches	13
Complete as described.....	\$65.80
Shipping weight, lbs.....	325
Code.....	Pintorio
Sink with back, legs and plug only.....	\$63.30

Without Porcelain Back, deduct \$12.00; without Nickel-Plated Legs and Braces, deduct \$10.00.

For prices on Porcelain and Iron Legs and Plugs, see page 374.

The Sink and Drain Shelves are made and fired in one piece and are glazed pure white inside and out. The Rim is rolled front and two ends, with flat back, so that it may be set up with Marble or Porcelain back, or set into Tiles. Can be set on either Legs or Brackets according to requirements.

In Orders and Specifications give Plate Number.

“LINCOLN” ROLL RIM KITCHEN SINKS.

IMPERISHABLE, SEAMLESS, CLEAN, NON-ABSORBENT AND MORE DURABLE THAN IRON.

These Sinks are carefully made of selected clays and glazed in light yellow.



1406-C.

Lincoln Roll Rim Kitchen Sink, with Bronzed Iron Legs, Wall Braces and Plug and Coupling with Nickel-Plated Strainer.

Code.....	Pinulam	Pinzare
Number.....	1	2
Outside dimensions, inches.....	20 1/2 x 31 1/2	23 1/2 x 37 1/2
Depth inside, inches.....	7	7
Complete as described.....	\$13.00	15.00
Code.....	Pinziamo	Pinzona
Sink only.....	\$8.00	10.00
Shipping weight, lbs.....	215	270

Bronzed Iron Legs and Wall Braces, per pair, \$3.00.

Plug and Coupling with Nickel-Plated Strainer, each, \$2.00

This Sink can be set into a Tile Wall or a Marble Back can be used.

In Orders and Specifications give Plate Numbers and Stock Numbers.

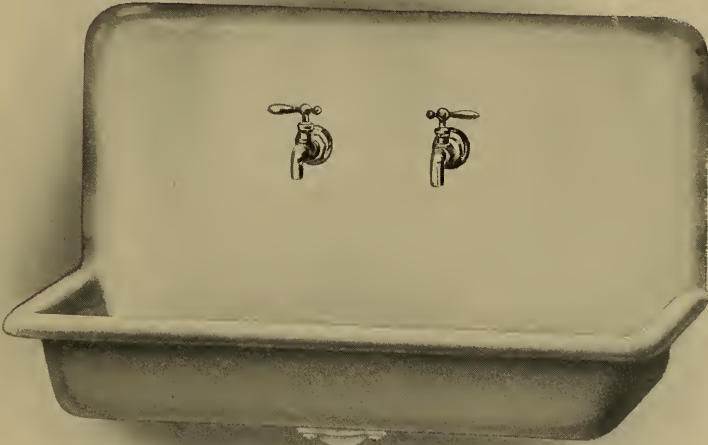
PORCELAIN ENAMELED SINKS.**1408-C.**

Porcelain Enameled Inside, Roll Rim Sink and Back, **all in one piece**, supported on Concealed Wall Hanger (similar to Hanger illustrated on page 363); Nickel-Plated Strainer; Nickel-Plated Fuller Bibbs and Flanges.

Code.....	Pioches	Piocheur	Piochons	Piogada	Pioggetta
Size, inches.....	16x24	18x30	20x30	20x36	20x40
Depth, inches.....	6	6	6	6	6
Height of back, inches.....	15	15	15	15	15
Complete as described.....	\$11.25	13.25	14.00	15.25	16.50
Shipping weight, lbs.....	125	145	155	170	215
Shipping measurement, cubic feet.....	6 $\frac{2}{3}$	8	8 $\frac{2}{3}$	10	10 $\frac{3}{4}$

If without Nickel-Plated Fuller Bibbs, deduct per pair, \$2.50.

If with Galvanized Air Chambers, add per pair, \$2.00.

If with 1 $\frac{1}{2}$ Nickel-Plated Sink Trap 1240-C, and Sink Connection 1261-C, add \$5.75.

If with 2 Nickel-Plated Sink Trap 1240-C, and Sink Connection 1261-C, add \$7.25.

One in a case.

In Orders and Specifications give Plate Numbers and Sizes.

PORCELAIN ENAMELED SINKS.

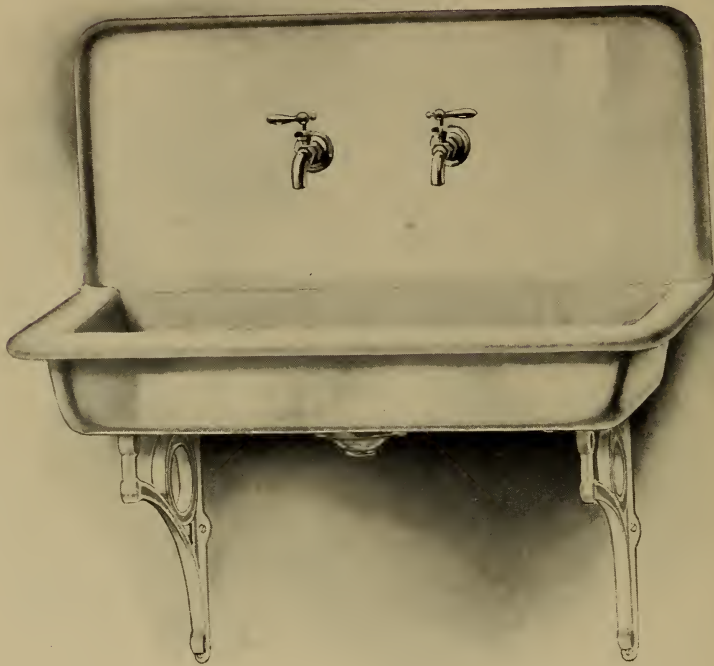

† 1410-C.

Porcelain Enameled Inside Roll Rim Sink and 15-inch Porcelain Enameled Back, with Brackets; Nickel-Plated Strainer; Nickel-Plated Fuller Bibbs and Flanges.

Code.....	Piomesi	Piometra	Pionagem	Pionahut	Pionias	Pionnage
Size, inches.....	16x24	18x30	20x30	18x36	20x36	20x40
Depth, inches.....	6	6	6	6	6	6
Complete as described.....	\$11.25	13.25	14.00	14.50	15.25	16.50
Shipping weight, lbs.....	120	140	150	170	177	210
Shipping measurement, cubic feet..	6	7¾	8¼	9½	9¾	10¼
If with 12-inch back, deduct.....	\$0.50	.75	.75	.75	.75	.75

If without Nickel-Plated Fuller Bibbs, deduct, \$2.50

If with Galvanized Concealed Air Chambers, add \$2.00.

If with 1½-inch Nickel-Plated Sink Trap 1240-C and Sink Connection 1261-C, add \$5.75.

If with 2-inch Nickel-Plated Sink Trap 1240-C and Sink Connection 1261-C, add \$7.25.

One in a case.

† Carried in San Francisco only.

In Orders and Specifications give Plate Numbers and Sizes.

PORCELAIN ENAMELED SINKS.

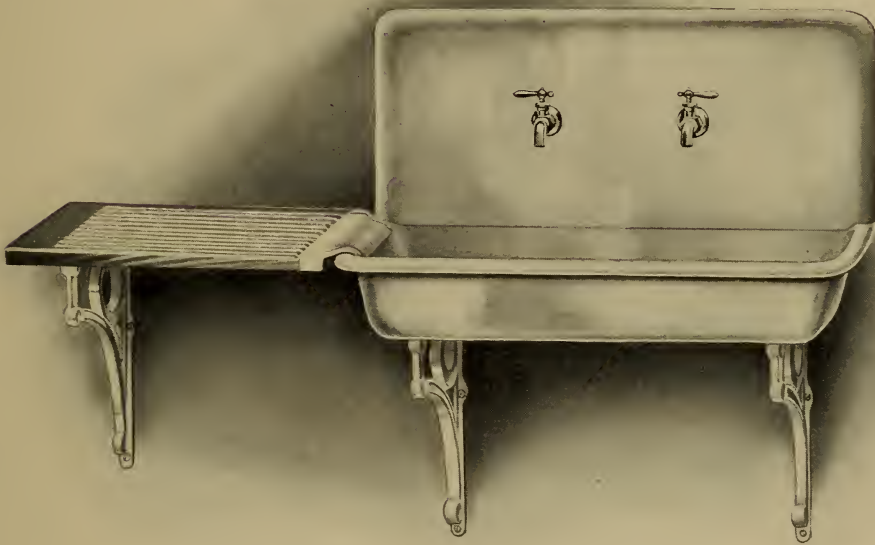

† 1412-C.

Porcelain Enameled Inside Roll Rim Sink and 15-inch Porcelain Enameled Back, Interchangeable Drain Board (18 inches long), with Porcelain Enameled End, 1444-C; Sink and Drain Board Brackets; Nickel-Plated Strainer; Nickel-Plated Fuller Bibbs and Flanges.

Code.....	Piophila	Pioppo	Piously	Piovendo
Size, inches.....	18x30	20x30	20x36	20x40
Depth, inches.....	6	6	6	6
Complete as described.....	\$16.75	17.75	18.00	20.25
Shipping weight, lbs.....	165	175	190	235
Shipping measurement, cubic feet.....	8¼	8¾	10½	11
If with Back 12 inches high, deduct.....	\$0.75	.75	.75	.75
If with Drain Board 24 inches long, add.....	.50	.50	.50	.50

If without Fuller Bibbs, deduct per pair \$2.50.

If with Galvanized Concealed Air Chambers, add per pair \$2.00.

One in a case.

† Carried in San Francisco only.

In Orders and Specifications give Plate Numbers and Sizes.

PORCELAIN ENAMELED SINKS.



† 1414-C.

Porcelain Enameled Inside Roll Rim Sink and 15-inch Porcelain Enameled Back and Left Hand End Piece, with one Bracket; Nickel-Plated Strainer; Nickel-Plated Fuller Bibbs and Flanges.

Code.....	Piovesse	Piovitura	Piovisita
Size, inches.....	18x30	20x30	20x36
Depth, inches.....	6	6	6
Complete as described.....	\$14.75	15.75	17.00
Shipping weight, lbs.....	170	175	205
Shipping measurement, cubic feet.....	8	8 $\frac{2}{3}$	9 $\frac{1}{2}$

If without Nickel-Plated Fuller Bibbs, deduct per pair, \$2.50.

If with Concealed Galvanized Air Chambers, add per pair, \$2.00.

One in a case.

† Carried in San Francisco only.

In Orders and Specifications give Plate Numbers and Sizes.

PORCELAIN ENAMELED SINKS.

† 1416-C.

Porcelain Enameled Inside Roll Rim Sink and 15-inch Porcelain Enameled Back and Right-Hand End Piece, with one Bracket, Nickel-Plated Strainer, Nickel-Plated Fuller Bibbs and Flanges.

Code.....	Pipabunt	Pipage	Piparote
Size, inches.....	18x30	20x30	20x36
Depth, inches.....	6	6	6
Complete as described.....	\$14.75	15.75	17.00
Shipping weight, lbs.....	170	175	205
Shipping measurement, cubic feet.....	8	8 $\frac{2}{3}$	9 $\frac{1}{6}$

If without Nickel-Plated Fuller Bibbs deduct, per pair, \$2.50

If with Concealed Galvanized Air Chambers add, per pair, \$2.00.

† Carried in San Francisco only.

In Orders and Specifications give Plate Numbers and Sizes.

PORCELAIN ENAMELED SINKS.

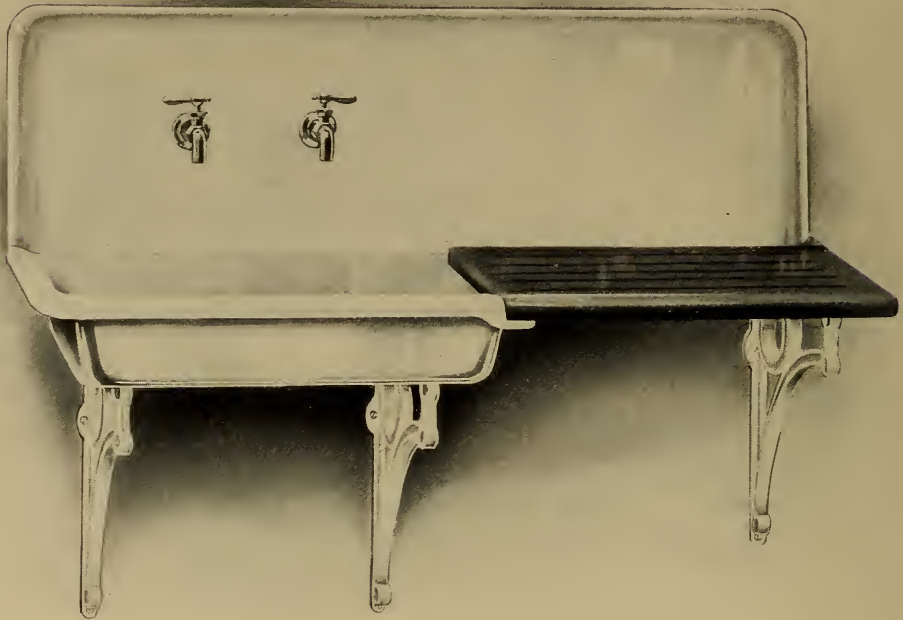

† 1418-C.

Porcelain Enameled Inside, Roll Rim Sink and 15-inch Porcelain Enameled Back over Sink and Drain Board; Right Hand Ash Drain Board (24 inches long) with Sink and Drain Board Brackets; Nickel-Plated Strainer; Nickel-Plated Fuller Bibbs and Flanges.

Code.....	Pipaste	Pipeau	Piperato	Pipewort	Pipfort
Size, inches.....	18x30	18x36	20x30	20x36	20x40
Depth, inches.....	6	6	6	6	6
Length over all, inches.....	54	60	54	60	64
Complete as described.....	\$20.40	21.65	21.35	22.60	23.85
Shipping weight, lbs.....	240	260	245	270	282
Shipping measurement, cubic feet.....	13	13½	14½	15¼	16½

If without Nickel-Plated Fuller Bibbs, deduct per pair, \$2.50.

If with Concealed Galvanized Air Chambers, add per pair, \$2.00.

Furnished with Nickel-Plated or Iron Traps when so ordered.

† Carried in San Francisco only.

In Orders and Specifications give Plate Numbers and Sizes.

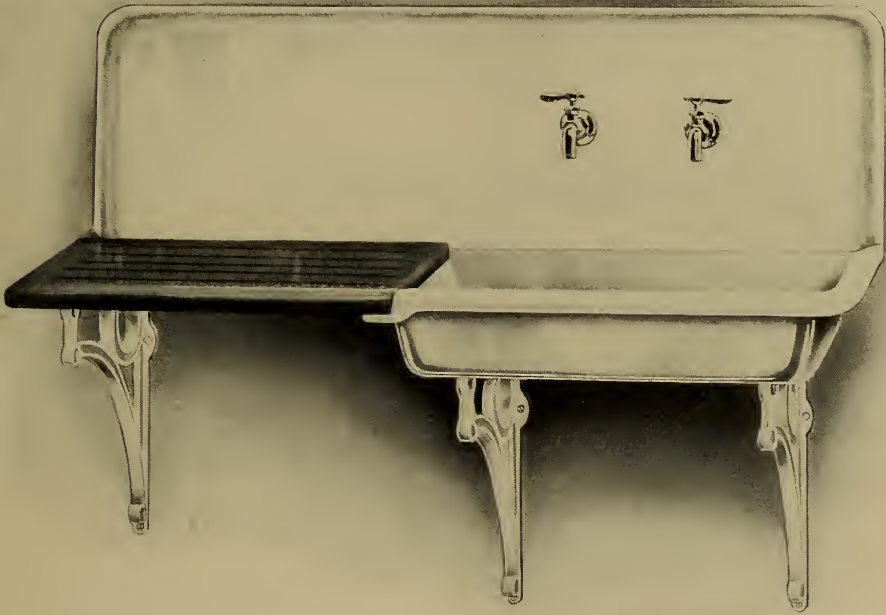
PORCELAIN ENAMELED SINKS.

† 1420-C.

Porcelain Enameled Inside Roll Rim Sink and 15-inch Porcelain Enameled Back Over Sink and Drain Board; Left Hand Ash Drain Board (24 inches long) with Sink and Drain Board Brackets; Nickel-Plated Strainer; Nickel-Plated Fuller Bibbs and Flanges.

Code.....	Piphano	Pipheus	Pipilabo	Pipilavit	Pipimust
Size, inches.....	18x30	18x36	20x30	20x36	20x40
Depth, inches.....	6	6	6	6	6
Length over all, inches.....	54	60	54	60	64
Complete as described.....	\$20.40	21.65	21.35	22.60	23.85
Shipping weight, lbs.....	240	260	245	270	282
Shipping measurement, cubic feet.....	13	13½	14¼	15¼	16½

If without Nickel-Plated Fuller Bibbs, deduct per pair, \$2.50.

If with Concealed Galvanized Air Chambers, add per pair, \$2.00.

Furnished with Nickel-Plated or Iron Traps when so ordered.

† Carried in San Francisco only.

In Orders and Specifications give Plate Numbers and Sizes.

PORCELAIN ENAMELED SINKS.



† 1422-C.

Porcelain Enameled Inside Roll Rim Sink, and 15-inch Porcelain Enameled Back over Sink and Drain Boards with Union Strips; Right and Left Ash Drain Boards (18 inches long) with Sink Legs and Drain Board Brackets; Nickel-Plated Strainer; Nickel-Plated Fuller Bibbs and Flanges.

Code.....	Pipinnis	Pipistrel	Pipizon	Pipjeau
Size, inches.....	18x30	20x30	20x36	20x40
Depth, inches.....	6	6	6	6
Length over all, inches.....	66	66	72	76
Complete as described.....	\$24.55	25.70	26.95	28.20
Shipping weight, lbs.....	260	265	285
Shipping measurement, cubic feet.....	10½	11½ ₁₂	12

If without Nickel-Plated Fuller Bibbs deduct, per pair, \$2.50.

If with Concealed Galvanized Air Chambers add, per pair, \$2.00

Brass Nickel-Plated or Iron Traps can be furnished for these Sinks.

† Carried in San Francisco only.

In Orders and Specifications give Plate Numbers and Sizes.

PORCELAIN ENAMELED SINKS.

† 1424-C.

Porcelain Enameled Exterior Sink with Apron all around; Enameled Sink Legs and Wall Support; 30-inch Right Hand "Perfection" Ash Drain Board, Hinged at End to Wall and 30-inch Left Hand "Perfection" Ash Drain Board with Nickel-Plated Telescope Support; Nickel-Plated Strainer; Nickel-Plated Fuller Bibbs and Flanges.

Code.....	Pipkins
Size, inches.....	24x42
Width of Apron, inches.....	7
Complete as described.....	\$54.50
Shipping weight, lbs.....	295

If without Nickel-Plated Fuller Bibbs, deduct per pair, \$2.50.

If without "Perfection" Ash Drain Boards, deduct, \$22.00.

Nickel-Plated or Iron Traps can be furnished for this Sink.

† Carried in San Francisco only.

In Orders and Specifications give Plate Numbers and Sizes.

PORCELAIN ENAMELED SINKS.



†1426-C. as shown. 1428-C. for Left End.

Cut shows fixture with Right End Piece.

When furnished with Left End Piece sink is on the opposite side of Wash Tray from that shown in cut.

Porcelain Enameled Inside Roll Rim Sink and Wash Tray Combination, and 15-inch Porcelain Enameled Back over Sink and Tray, with Union Strip, Porcelain Enameled End Piece and Painted Wash Tray Pedestal, Nickel-Plated Wash Tray Plug and Coupling with Rubber Stopper, and Soap Dish; Nickel-Plated Sink Strainer; Nickel-Plated Fuller Sink and Wash Tray Bibbs with Flanges.

Code for Right End.....	Pipuncle	Piquades
Code for Left End.....	Piquancy	Piqueron
Size of sink, inches.....	20x30	20x36
Depth of sink, inches.	6	6
Complete as described.....	\$44.75	46.00
Shipping weight, lbs.....	405	425

If with Nickel-Plated Vented "S" Traps under Sink and Wash Tray, add each \$5.75.

If without Fuller Sink and Wash Tray Bibbs, deduct for all, \$5.00.

If with Concealed Galvanized Air Chambers on Sink, add per pair, \$2.00.

In ordering, always state whether wanted with Right or Left End Piece.

† Carried in San Francisco only.

In Orders and Specifications give Plate Numbers and Sizes.

PORCELAIN ENAMELED SINKS.

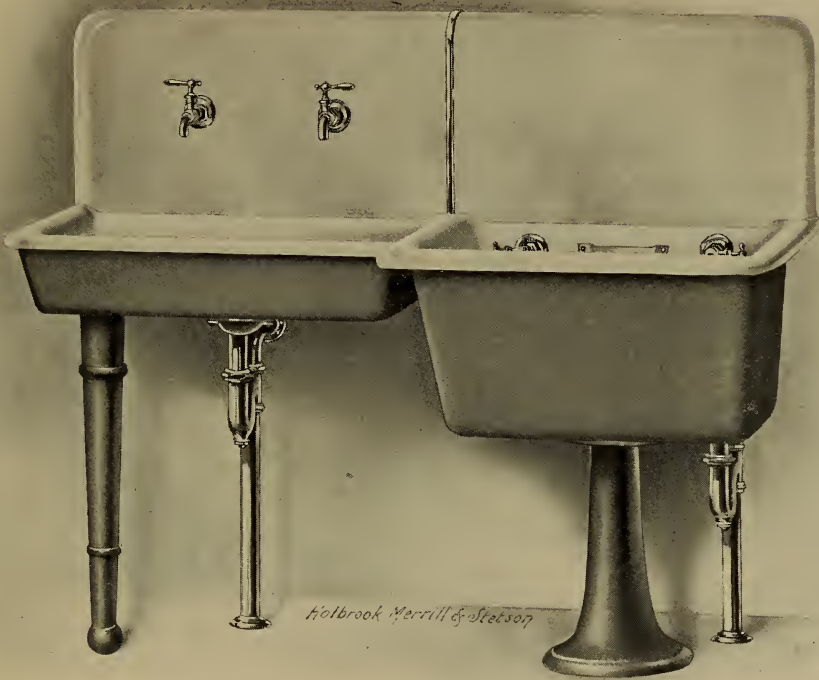

† 1429-C.

Cut shows fixture with Sink on Left Side of Wash Tray.

Porcelain Enameled Inside Roll Rim Sink and Wash Tray Combination, and 15-inch Porcelain Enameled Back Over Sink and Tray with Union Strip; Painted Wash Tray Pedestal and Sink Leg; Nickel-Plated Wash Tray Plug and Coupling with Rubber Stopper and Soap Dish; Nickel-Plated Sink Strainer; Nickel-Plated Fuller Sink and Wash Tray Bibbs with Flanges; Nickel-Plated Vented "S" Traps on Sink and Tray.

Code for Left Hand.....	Piquesus	Piquobo
Code for Right Hand	Piquette	Piquoent
Size of sink, inches.....	20x30	20x36
Depth of sink, inches	6	6
Complete as described	\$54.75	56.00
Shipping weight, lbs	405	425

If without Sink or Tray Trap, deduct each, \$5.75.

If without Fuller and Wash Tray Bibbs, deduct for all, \$5.00.

If with Concealed Galvanized Air Chambers, add per pair, \$2.00.

In ordering always state whether wanted with Sink on Right or Left side of Wash Tray.

† Carried in San Francisco only.

In Orders and Specifications give Plate Numbers and Sizes.

PORCELAIN ENAMELED SINKS.



1430-C.

Porcelain Enameled Flat Rim Sink with 15-inch Deep Pattern Porcelain Enameled Back, Painted Brackets, Nickel-Plated Strainer and Nickel-Plated Fuller Bibbs with Flanges.

Code.....	Pirabebe	Piracant	Piragone	Piraguas	Piramena	Piratage	Pirathon
Size, inches.....	†16x24	†18x24	18x30	18x36	20x30	20x36	†20x40
Depth, inches.....	6	6	6	6	6	6	6
Complete as described.....	\$9.25	9.50	11.00	13.00	11.00	12.50	14.25
Shipping weight, lbs.....	100	109	116	132	123	135	161
If with Back 12 inches high, deduct...	\$0.50	.50	.75	.75	.75	.75	.75
* If with Shallow Pattern Backs, deduct	.80	.80	.95	1.10	.95	1.10	1.20

If with Concealed Galvanized Air Chambers, add per pair, \$2.00.

If without Nickel-Plated Fuller Bibbs, deduct per pair, \$2.50.

* Concealed Air Chambers cannot be used with Shallow Pattern Backs.

† Carried in San Francisco only.

In Orders and Specifications give Plate Numbers and Sizes.

PORCELAIN ENAMELED SINKS.



1432-U.

Porcelain Enameled Flat Rim Sink with 12-inch Shallow Pattern Back and Right Hand End Piece; Painted Bracket; Nickel-Plated Strainer and Nickel-Plated Fuller Bibbs with Flanges.

Code for Right End.....	Pirenid	Pirgoma	Pirinola	Piritus	Pirlito	Pirofago	Piروفانه
Code for Left End.....	Pirogues	Pirolace	Piromaca	Piropear	Piroscafo	Pirosfera	Pirosseno
Sizes, inches.....	†16x24	†18x24	18x30	†18x36	20x30	†20x36	†20x40
Depth, inches.....	6	6	6	6	6	6	6
Complete as described.....	\$8.75	9.00	10.25	11.25	10.50	11.75	13.50
Shipping weight, lbs.....	110	120	160	175	150	180	195

If without Nickel-Plated Fuller Bibbs, deduct per pair \$2.50.

Concealed Air Chambers cannot be used with above sink backs.

When ordering specify whether wanted with Right or Left End Piece.

Brass or Iron Sink Traps can be furnished for these sinks.

† Carried in San Francisco only.

In Orders and Specifications give Plate Numbers and Sizes.

FACTORY WASH SINKS.



1434-C.

Extra Heavy Painted Iron Factory Wash Sink on Standards; fitted with 3/4-inch Galvanized Supply Pipe and Painted Supports over center of Sink; 1/2-inch Compression Bibbs; Soap Cups with Perforated Bottoms; Standing Overflow, and 2-inch Painted Cast Iron S Trap with Brass Trap Screw.

Code.....	Pisaban	Pisadella	Pisadura	Pisaflore	Pisandros	Pisanorum
Size, inches.....	24x60	24x72	24x84	24x96	24x108	24x120
Depth, inches.....	6	6	6	6	6	6
Sink, less Bibbs and Stop.....	\$25.75	29.00	33.25	35.50	38.00	41.00
Shipping weight, lbs.....	175	200	275	325	340	350

Add for Finished Compression Bibbs, each, \$1.00.

Add for Rough Brass Stop and Supply Pipe from floor to Sink, \$1.50.

Trap can be furnished with Hub Vent at same price, if desired.

Above Sink can be furnished to set against the wall with Supply Pipes and Supports over back edge of Sink. Prices upon application.

In Orders and Specifications give Plate Numbers and Sizes.

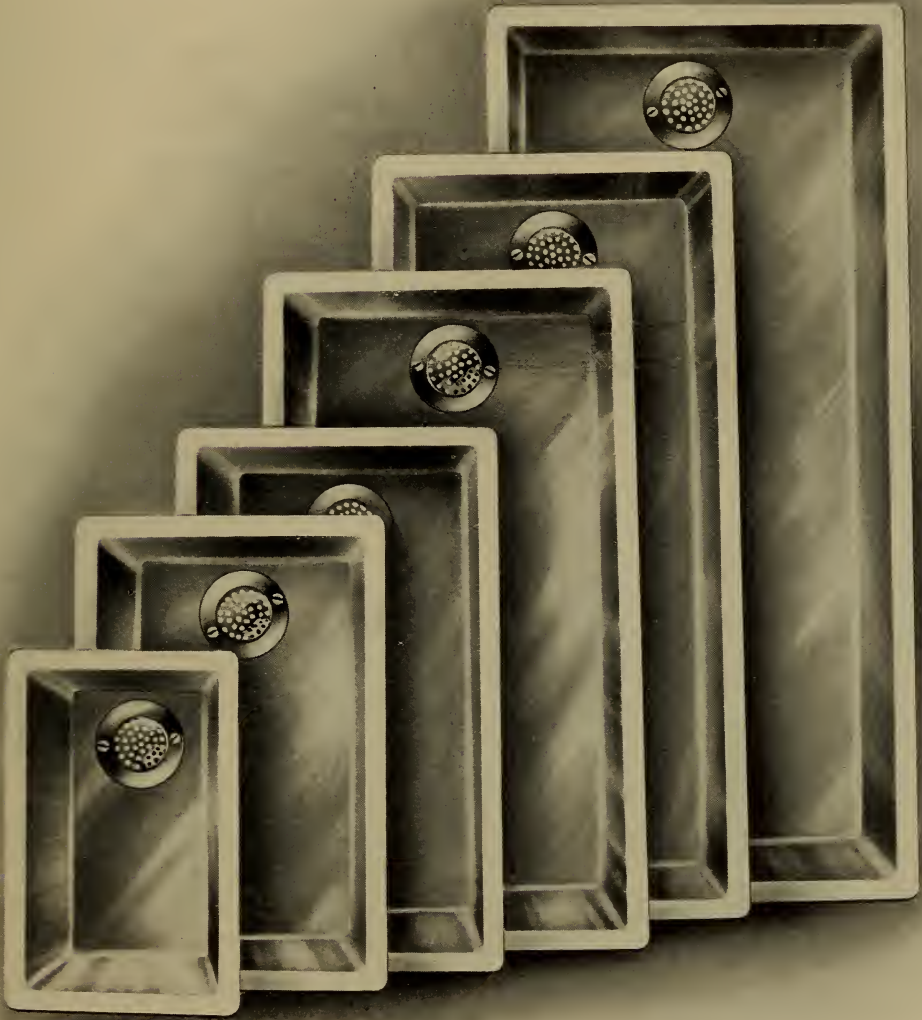
PORCELAIN ENAMELED SINKS.**1436-C.**

Porcelain Enameled Regular Flat Rim Kitchen Sinks with Nickel-Plated Strainers, Bolts, Nuts and Couplings.

These Sinks are made with Porcelain Enameled Rims and Rounded Corners.

For Sizes and Prices see Page 392.

In Orders and Specifications give Plate Numbers and Sizes.

PORCELAIN ENAMELED SINKS.

Illustrated and described on page 391.

Code.....	Piscantine	Piscarium	Piscary	Piscation
Size, inches.....	† 14x20	† 16x20	16x24	† 17x28
Each.....	\$3.00	3.15	3.25	3.75
Shipping weight each, lbs.....	38	37	49	54½
Code.....	Piscatrice	Piscemur	Piscolabis	Pisculento
Size, inches.....	18x24	18x30	† 18x32	18x36
Each.....	\$3.50	4.25	4.65	4.75
Shipping weight each, lbs.....	49	56	66	67
Code.....	Pisellone	Pisenor	Pisidicus	Pisinnum
Size, inches.....	† 20x24	20x30	20x36	† 22x36
Each.....	\$3.75	4.50	5.25	5.50
Shipping weight each, lbs.....	54	63	70	80
Code.....	Pisnets	Pisolithic	Pispannes	Pispiglio
Size, inches.....	20x40	22x42	24x48	† 24x50
Each.....	\$5.75	6.25	7.75	9.00
Shipping weight each, lbs.....	86	105	127	147

If with Nickel-Plated Plug Strainer with Rubber Stopper (1469-C), add each, \$0.35.

CALVANIZED SINKS.

Same as shown and described on page 391 but Galvanized instead of Enameled.

Code.....	Pispola	Pissando
Size, inches.....	24x50	24x60
Depth, inches.....	6	6
Each.....	\$9.00	30.00
Shipping weight, lbs.....	145

PORCELAIN ENAMELED SINKS.



† 1438-C.

Porcelain Enameled Regular Flat Rim Kitchen Sink, with Overflow, Nickel-Plated Strainer and Rubber Stopper.

Code.....	Pissequi	Pissodes	Pissophan	Pistabunt
Size, inches.....	14x20	16x24	18x30	20x30
Each, as described.....	\$5.00	5.25	6.25	6.50
Shipping weight, lbs.....	34	50	57	65

† Carried in San Francisco only.

In Orders and Specifications give Plate Numbers and Sizes.

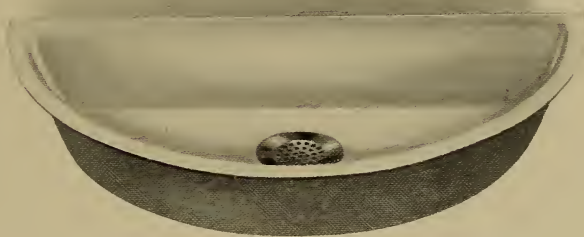
PORCELAIN ENAMELED SINKS.

† 1440-C.

PORCELAIN ENAMELED HALF-CIRCLE SINK, WITH NICKEL-PLATED STRAINER.

Code.....	Pistache	Pistagnon	Pistavit	Pistazite
Numbers.....	1	2	5	6
Size, inches.....	14x24x6	14x27x6	16x29x6	17x31x6
Each.....	\$3.45	4.00	4.55	5.15
Shipping weight, lbs.....	26	28	32	33

If with Plug Strainer and Rubber Stopper add, each, \$0.35.



† 1442-C.

PORCELAIN ENAMELED CORNER SINK, WITH NICKEL-PLATED STRAINER.

Code.....	Pisteurs	Pisticum	Pistill
Numbers.....	1	3	5
Size, inches.....	17x24x6	20x27x6	22x31x6
Each.....	\$3.70	4.50	5.60
Shipping weight, lbs.....	19	28	34

If with Nickel-Plated Plug Strainer and Rubber Stopper add, each, \$0.35.

† Carried in San Francisco only.

In Orders and Specifications give Plate Numbers and Sizes.

SINK DRAIN BOARDS.

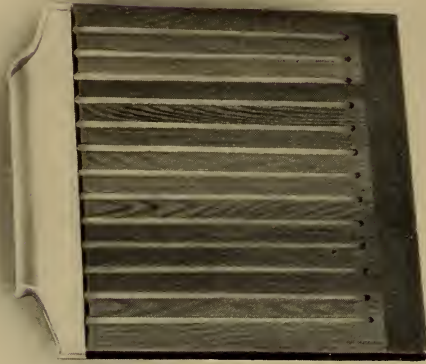

† 1444-C.



† 1444-C. Bottom View.

Interchangeable Hardwood Drain Board, with Porcelain Enamelled End for attaching to Roll Rim Sink.

At the Sink End of the Board is an Enamelled Iron Attaching Piece, made to fit over the Roll Rim, and can be used on any Full Roll Rim Sink.

18 INCHES LONG.

Code.....	Pistolaco	Pistolette
Width, inches.....	18	20
Each.....	\$3.00	3.25
Weight each, lbs.....	21	22

24 INCHES LONG.

Code.....	Pistorin	Pistrice
Width, inches.....	18	20
Each.....	\$3.50	3.75
Weight each, lbs.....	24	25

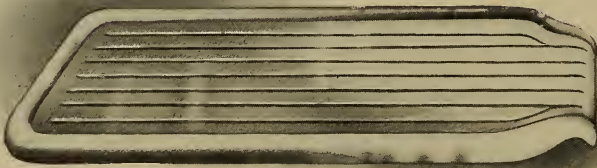

1446-C.

Porcelain Enamelled Interchangeable Drain Board. Can be used with any Kitchen Sink.

† 18 INCHES LONG.

Code.....	Pistriger	Pistrilla
Width, inches.....	18	20
Each.....	\$3.25	3.50
Weight each, lbs.....	50	54

24 INCHES LONG.

Code.....	Pistrino	Pistrix
Width, inches.....	18	20
Each.....	\$3.75	4.00
Weight each, lbs.....	57	60

† Carried in San Francisco only.

In Orders and Specifications give Plate Numbers and Sizes.

DRAIN BOARD MATS.

AIR CHAMBERS FOR SINK BACKS.

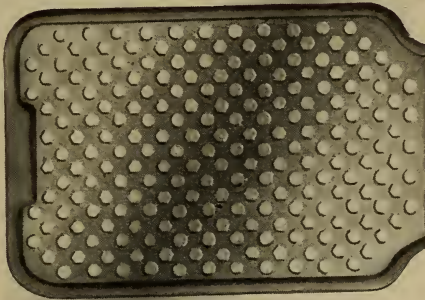

1448-C.

1449-C.

Perforated Rubber Mat for Porcelain Enameled Drain Boards.

Concealed Galvanized Air Chamber for Deep Pattern Sink Backs.

18 INCHES LONG.		24 INCHES LONG.	
Code.....	Pisuram Pisuros	Code.....	Pitanca Pitapat
For Drains in width, in.	18 20	For Drains in width, in.	18 20
Each.....	\$2.25 2.50	Each.....	\$2.75 3.00

Code.....	Pitarche
Each.....	\$1.00
Weight each, lbs.....	10

HARDWOOD MATS OR GRATINGS FOR ENAMELED SINKS.

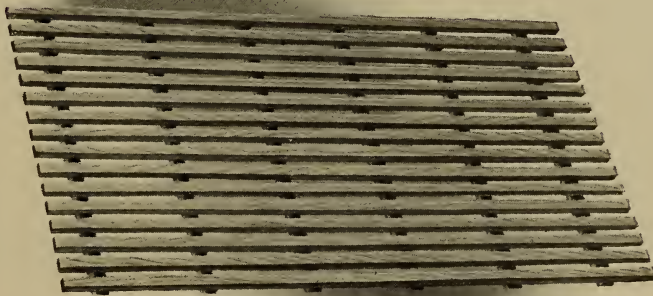

1450-C.

Hardwood Mat for Flat or Roll Rim Sinks.

Code.....	Pitcoal	Piteous	Pitezna	Pitfall	Pithenor	Pithily
For Sinks, inches.....	16x24	18x30	18x36	20x30	20x36	20x40
Each.....	\$1.50	2.25	3.00	2.25	3.00	3.50
Weight each, lbs.....	5	7	8	7	8	9

When ordering state width and length and style of Sink to be used with.

In Orders and Specifications give Plate Numbers and Sizes.

PORCELAIN ENAMELED SINK BACKS.



1452-U.

Porcelain Enameled Roll Rim Shallow Pattern Sink Back. 12 inches high. Concealed Air Chambers cannot be used with this Back. Can be used only on regular Flat Rim Sinks.

Code.....	Pithom	Piticos	Pitipie	Pitman	Pitocchio
Length, inches.....	24	30	36	40	48
Each.....	\$2.20	2.80	3.40	3.80	5.00
Weight each, lbs.....	30	37	46	55	75

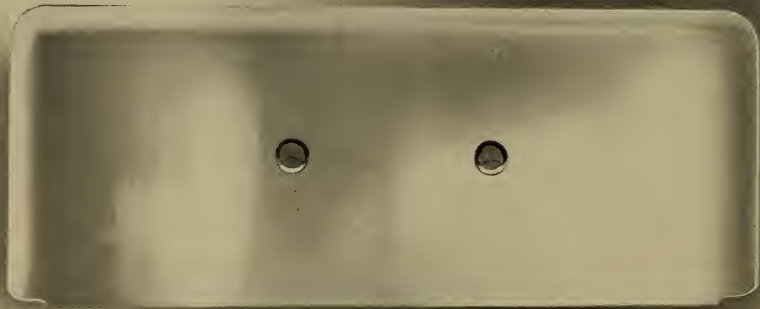

1454-C.

Porcelain Enameled Roll Rim Deep Pattern Sink Back. Can be used with regular Flat Rim or Roll Rim Sinks, and with or without Air Chambers.

15 INCHES HIGH.

Code.....	Pitonille	Pitonisa	Pitriion	Pittacal
Length, inches...	24	30	36	40
Each.....	\$3.00	3.75	4.50	5.00
Weight each, lbs.	45	50	55	65

12 INCHES HIGH.

Code.....	Pittakos	Pittance	Pittheis	Pittizite
Length, inches...	24	30	36	40
Each.....	\$2.50	3.00	3.75	4.25
Weight each, lbs.	40	45	50	60

In Orders and Specifications give Plate Numbers and Sizes.

PORCELAIN ENAMELED SINK BACKS.



1456-C.



1457-C.

Porcelain Enameled Deep Pattern End Piece for Flat Rim and Roll Rim Sinks, 15 inches High.

Code, Right Hand....	Piugas	Piulco	Piuma	Piumone
Code, Left Hand.....	Pivanes	Pivert	Pivoin	Pivotted
Length, inches.....	†16	18	20	†22
Each	\$1.75	2.00	2.25	2.50
Weight each, lbs.....

Porcelain Enameled Shallow Pattern End Piece for Flat Rim Sinks, 12 inches High.

Code, Right Hand..	Pizate	Pizcando	Pizcaria	Pizmienta
Code, Left Hand...	Plaagden	Plaatbal	Plaatpers	Plaatsen
Length, inches	†16	18	20	†22
Each.....	\$1.50	1.75	2.00	2.25
Wt. ea., lbs.....

In ordering always state whether Right or Left Hand End is wanted.

CAMPBELL SINK BRACKETS.

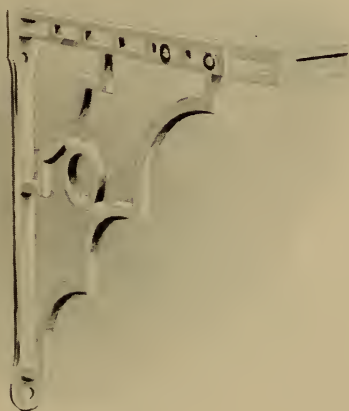

1460-C.

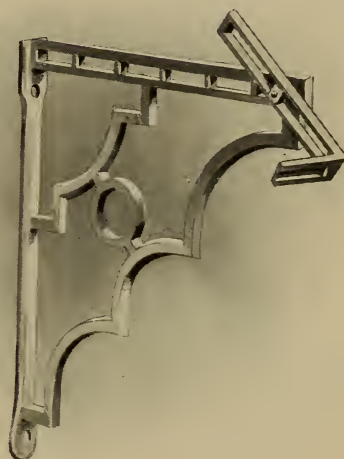

1460-C.

Adjustable Cast Iron Sink Brackets for Flat or Roll Rim Sinks. For Sinks from 14 to 20 inches wide.

PAINTED.

* NICKEL-PLATED.

Code.....	Placammo
Each.....	\$0.75
Weight each, lbs.....	15

Code.....	Placandola
Each.....	\$1.00
Weight each, lbs.....	5

* Nickel-Plated Brackets are first Electro-Copper Plated, then Nickerled, thus preventing rust so common with Cast Iron Nickel-Plated Brackets.

† Carried in San Francisco only.

In Orders and Specifications give Plate Numbers and Sizes.



1462-C.

PAINTED IRON SINK BRACKETS.

1462-C.

Code.....	Placabaw	Placabent	Placabfast
Number.....	1	2	3
For sinks up to in. wide....	14	18	22
Each.....	\$0.35	.50	.75
Weight each, lbs.

HAMMOND DESIGN SINK BRACKET.

FOR ROLL RIM SINKS.

Iron Porcelain Enameled. 1464-C.

Code.....	Placaccept	Placacers	Placacetal	Placadade
Size, inches	16	18	20	22
Per pair.....	\$1.50	2.00	2.50	3.00

Brass, Nickel-Plated. 1464-C.

Code.....	Placadent	Placadist	Placadole	Placadust
Size, inches	16	18	20	22
Per pair.....	\$6.00	8.00	10.00	12.00

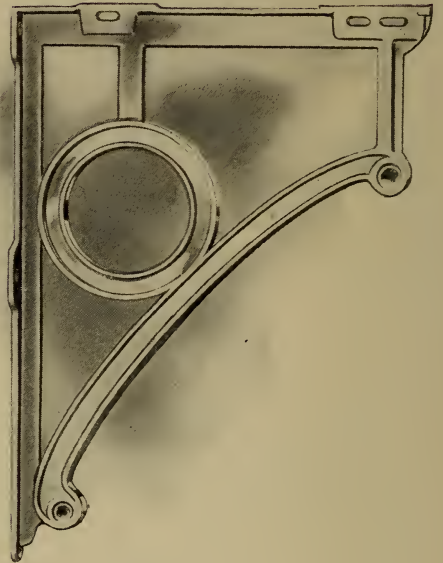

†1464-C.

FITTINGS FOR CAST IRON SINKS.

SHORT BRASS SINK BOLTS, WITH NICKEL-PLATED HEAD AND ONE IRON NUT.



Code.....	Placacast
Per dozen.....	\$0.55
Weight per dozen, lbs.....	½

1466-C.

LONG BRASS SINK BOLTS WITH TWO IRON NUTS.

Code.....	Placagast
Per dozen.....	\$0.70
Weight per dozen, lbs.....	1

† Carried in San Francisco only.

LONG IRON SINK BOLTS, WITH TWO IRON NUTS.

Code.....	Placaloon
Per dozen.....	\$0.50
Weight per dozen, lbs.....	1

In Orders and Specifications give Plate Numbers and Sizes.

FITTINGS FOR CAST IRON SINKS.

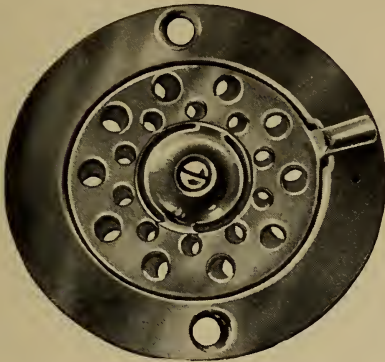

1472-C.

Nickel-Plated Duffy Sink Strainer. 1472-C.

Code.....	Placeaba	Placeamos
Size, inches.....	1½	1¾
Center to center of holes.....	3⅝	3¾
Each.....	\$0.75	.80
Weight each, lbs.....	⅝	⅞

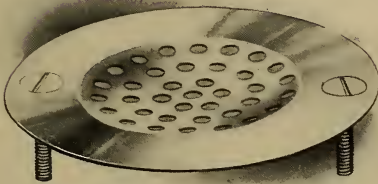

1468-C.

Open Sink Strainer. Nickel-Plated Brass.

Code.....	Placarlo
Per dozen.....	\$4.00
Weight per dozen, lbs.....	2

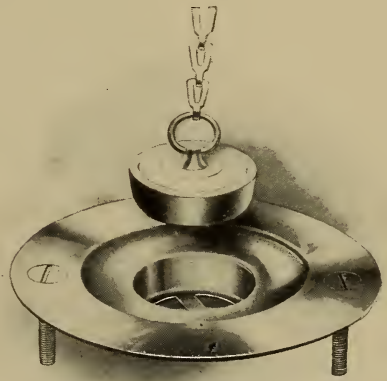

1469-C.

Plug Sink Strainer. Nickel-Plated Brass, with Rubber Stopper.

Code.....	Placativo
Per dozen.....	\$8.00
Weight per dozen, lbs.....	4½

If furnished with Bolts and Nuts as shown, add per dozen, \$0.50.



1470-C.

Painted Iron Sink Coupling for Lead Pipe Connection.

Code.....	Placatrix
Per dozen.....	\$1.25
Weight per dozen, lbs.....	8



1471-C.

Painted Iron Sink Coupling for Iron Pipe Connection.

Code.....	Placatune	Placavel	Placavont
Size pipe, inches....	1¼	1½	2
Each.....	\$0.60	.60	.60
Weight each, lbs....	1	1	1

In Orders and Specifications give Plate Numbers and Sizes.

COLUMBUS WROUGHT STEEL KITCHEN SINKS.

FLAT EDGE. IMPROVED BRASS COUPLINGS WITH REMOVABLE STRAINERS.

Couplings made for connection with 1½-inch Standard Iron Pipe or Lead Pipe.



† 1480-C.

PAINTED.

Code.....	Placusa	Placystes	Pladarose	Plattebar	Plafond	Plagaban
Size, inches.....	16x24	18x30	18x36	20x30	20x36	20x40
Depth, inches.....	6	6	6	6	6	6
Each, complete.....	\$2.00	2.50	3.00	3.00	3.70	4.00
Weight each, lbs.....	12	14	16	19	20	20
Shipping meas. each, cu. ft.....	1½	1¾	2¼	2	2½	2¾

GALVANIZED.

Code.....	Plagalium	Plagandus	Plagellis	Plaggon	Plagiat	Plagies
Size, inches.....	16x24	18x30	18x36	20x30	20x36	20x40
Depth, inches.....	6	6	6	6	6	6
Each, complete.....	\$4.00	5.10	6.50	6.25	7.75	8.50
Weight each, lbs.....	12	14½	18	19	21	21

GRAY ENAMELED.

Code.....	Plagiopos	Plagusie	Plaguily	Plaice	Plaidais	Plaidera
Size, inches.....	16x24	18x30	18x36	20x30	20x36	20x40
Depth, inches.....	6	6	6	6	6	6
Each, complete.....	\$6.50	8.00	9.50	9.00	10.50	11.50
Weight each, lbs.....	13	17	18	17½	21	22

WHITE ENAMELED.

Code.....	Plaideur	Plaignant	Plaignisse	Plaindron	Plaintful	Plairont
Size, inches.....	16x24	18x30	18x36	20x30	20x36	20x40
Depth, inches.....	6	6	6	6	6	6
Each, complete.....	\$7.50	9.50	11.00	10.50	12.00	13.00
Weight each, lbs.....	13	17	18	17½	21	22

Sinks furnished with Rubber Plugs when so ordered, but Plugs are charged extra.

† Carried in San Francisco only.

In Orders and Specifications give Plate Numbers, Size and Finish.

“COLUMBUS” IMPROVED SINK COUPLINGS.

BRASS.

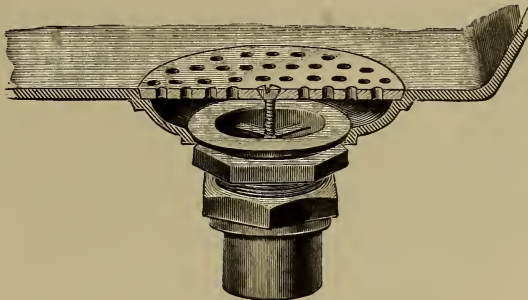

† 1481-C.

Sectional View Showing Method of Connecting Pipe.

The above Cut represents our New Coupling Complete Attached to Sectional View of Sink; below is the Coupling detached. “A” is a Ferrule having one end flanged to fit Sink and the other end threaded for 1½-inch Standard Iron Pipe. “B” is a Locknut. “C” is a Standard Coupling in two parts for making lead pipe connection. “R” is a Powell’s Patent Star Metal Cored Rubber Stopper or Plug, which fits Ferrule “A.”

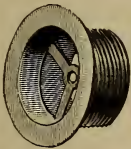

A

1482-C.



B

1483-C.

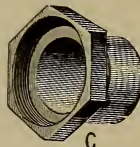

C

1484-“C”.



1485-“C”.

“A.” Ferrule.		“B.” Locknut.		“C.” Coupling.		“R.” Plug.	
Code.....	Plaisote	Code.....	Plaisun	Code.....	Plaitot	Code.....	Plaitum
Each.....	\$0.25	Each.....	\$0.10	Each.....	\$0.35	Each.....	\$0.10

Other Parts of Columbus Sink Couplings not shown.

Code.....							
Plamee.....	Coupling complete with Painted Strainer.....					Each,	\$0.60
Plamoter.....	“ “ “ Galvanized Strainer.....					“	.70
Planador.....	“ “ “ Enameled “					“	.80
Planagete.....	“ “ “ Nickel-Plated “					“	.85
Planarida.....	Painted Strainer only.....					“	.10
Planasia.....	Galvanized “ “					“	.20
Planaxes.....	Enameled “ “					“	.25
Plancam.....	Nickel-Plated Strainer only.....					“	.25
Planchado.....	Brass Screws.....					“	.06
Plancheur.....	“ “ with Nickel-Plated Heads.....					“	.06
Planeten.....	Leather Washers.....					“	.05
Planetoid.....	Rubber “					“	.05
Planetule.....	Solder Nipple, no Nut.....					“	.25
Plangebat.....	Coupling Nut only.....					“	.10

In making connection drop Ferrule “A” through neck of Sink. Tight joint may be made with a thin roll of Putty placed under the flanged end of Ferrule A, or with a Rubber Gasket before dropping through Sink. Screw Locknut B against neck of Sink, making a Tight Joint. In connecting Iron Pipe, attachment is made direct to Ferrule “A,” which has a 1½-inch Standard Iron Pipe Thread, by means of a Standard Iron Pipe Fitting. In attaching Lead Pipe, solder Pipe to Coupling B, then screw the Coupling to Ferrule A.

This method of attachment is simple and reliable. It avoids work in cramped position. There can be no leakage. Strainer is held in position by a Brass Screw passing into cross piece on inside of Ferrule “A,” and can be removed and dirt forced from pipe without disconnecting Pipe from Sink.

† Carried in San Francisco only.

In Orders and Specifications give Plate Numbers and Names.

“NEW ERA” WROUGHT STEEL KITCHEN SINKS.

FLAT EDGE.

These Sinks are stamped with a long neck so shaped as to receive Lead Pipe which is attached in the usual manner same as on Cast Iron Sinks. Direct Iron Pipe connection is made by the use of Cast Iron Nipple A (see page 403).

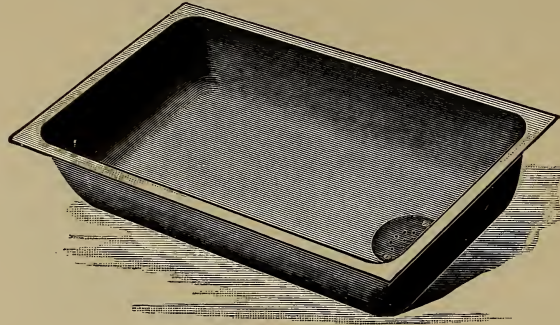

1486-C.

PAINTED.

Code.....	Plantent	Plangeris	Planherd	Planiceps	Planiglob	Planimetro
Size, inches.....	16x24	18x30	18x36	20x30	20x36	20x40
Depth, inches.....	6	6	6	6	6	6
Each, complete.....	\$2.00	2.50	3.00	3.00	3.70	4.00
Weight each, lbs.....	9	13	17	15	18	19
Shipping meas. each, cu. ft. ..	1 1/3	1 5/8	2 1/4	2	2 1/2	2 3/4

GALVANIZED.

Code.....	Planipedes	Planless	Plannest	Planorbes	Planorum	Planquer
Size, inches.....	† 16x24	18x30	† 18x36	20x30	† 20x36	† 20x40
Depth, inches.....	6	6	6	6	6	6
Each, complete.....	\$4.00	5.10	6.50	6.25	7.75	8.50
Weight each, lbs.....	10	15	17 1/2	17	20	20 1/2

BLUE ENAMELED INSIDE AND OUTSIDE.

Code.....	Plantages	Plantains	Plantard	Plantemos	Planthout	Plantillar
Size, inches.....	16x24	18x30	18x36	20x30	20x36	20x40
Depth, inches.....	6	6	6	6	6	6
Each, complete.....	\$4.80	6.00	6.75	6.75	7.50	9.75
Weight each, lbs.....	9 1/2	14	17	16	17	21

GRAY ENAMELED.

Code.....	Plantista	Plantlet	Plantoir	Plantules	Planudos	Planulite
Size, inches.....	16x24	18x30	18x36	20x30	20x36	20x40
Depth, inches.....	6	6	6	6	6	6
Each, complete.....	\$6.50	8.00	9.50	9.00	10.50	11.50
Weight each, lbs.....	10	14	17	16	17	21

WHITE ENAMELED.

Code.....	Plappart	Plaque	Plaqueette	Plaquer	Plaseam	Plashoot
Size, inches.....	16x24	18x30	18x36	20x30	20x36	20x40
Depth, inches.....	6	6	6	6	6	6
Each, complete.....	\$7.50	9.50	11.00	10.50	12.00	13.00
Weight each, lbs.....	10	14	17	16	17	21

Plug, Strainer and Nipple for iron pipe connection supplied when ordered, but are charged extra.

† Carried in San Francisco only.

In Orders and Specifications give Plate Number, Size and Finish.

“NEW ERA” SINK COUPLINGS.

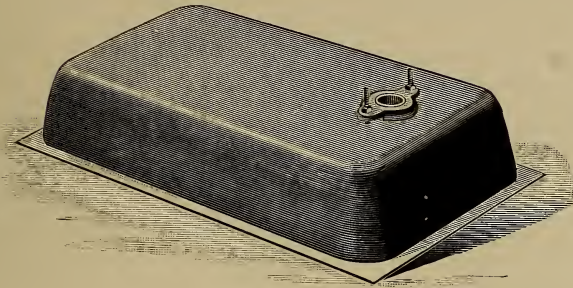

1487-C.

COUPLING FOR LEAD PIPE.

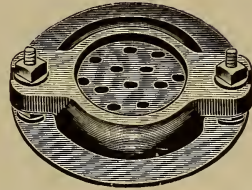

1491-C.

PLUG STRAINER.



1490-C.

“A” NIPPLE FOR IRON PIPE CONNECTION.



1492-C.

RUBBER PLUG.

Code.....	Plasmando	Plasmata	Code.	Plasmatic	Plasmome	Plassabor	Code.....	Plassors
Size, inches..	1¼	1½	Each..	Painted	Galvanized	Enameled	Each.....	\$0.10
Each.....	\$0.25	.30	Each..	\$0.15	.15	.20		

OTHER PARTS OF “NEW ERA” SINK COUPLINGS NOT SHOWN.

Code	Code
Plastica.....Painted Strainers.....Each, \$0.10	PlatbekShort Brass Bolts, with
Plastiker.....Galvanized “ “ .20	Nickel-Plated Heads.....Each, \$0.05
PlastronEnameled “ “ .25	Plateau.....Long Brass Bolts..... “ .05
Platagone.....Nickel-Plated Strainers.. “ .25	Platebock.....Long Brass Bolts with
Platanier.....Iron Clamps..... “ .15	N. P. Heads..... “ .05
Platband.....Short Brass Bolts..... “ .05	PlatecuerLeather Washers..... “ .05

“NEW ERA” SINK BRACKETS.

Suitable for all sizes of Roll Rim “New Era” Sinks, see 1494-C.

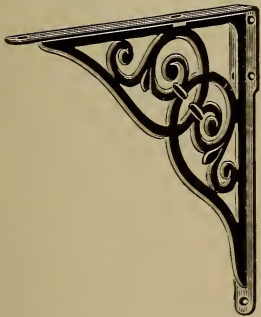

1493-C.

Provided with a set screw that securely holds sink on bracket.

Code.....	Plateful	Platement
Inches . . .	Painted	Galvanized
Per pair.....	15	15
Weight, per pair.....	\$1.15	1.45
	7½	8

In Orders and Specifications give Plate Numbers and Names.

“NEW ERA” ROLLED RIM WROUGHT STEEL SINKS.

FOR OPEN PLUMBING.

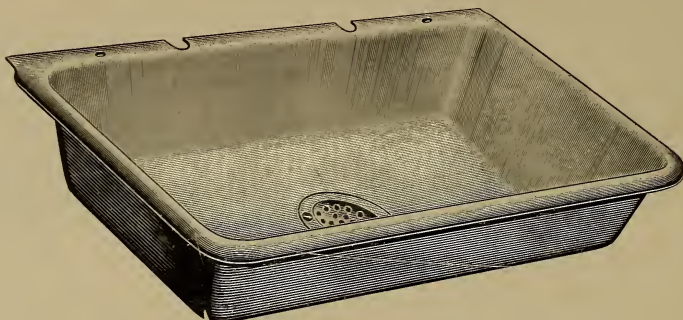

1494-C.

These Sinks, like the “New Era” Flat Rim Sinks, are furnished with cast iron coupling for lead pipe, and can be connected with iron pipe by use of the nipple A (see page 403). “New Era” Rolled Rim Steel Sinks are fastened to the brackets by means of the sleeve formed by the roll of the rim on the ends of the sink. The flange of the bracket fits into the sleeve. To hold the sink still more firmly in place there is a set screw on the under side of the bracket which turns up against the under side of the sink rim. By putting the Sink on the brackets in this manner a smooth surface is obtained, the rim being left free from screws such as are used on other rolled rim steel sinks. For brackets see page 403.

PAINTED.

Code.....	Platessa	Platicada	Platicame	Platicaron	Platicos	Platinage
Size, inches.....	16x24	18x30	18x36	20x30	20x36	20x40
Depth, inches.....	6	6	6	6	6	6
Each, complete.....	\$2.25	2.70	3.25	3.25	4.00	4.30
Weight each, lbs.....	11	16	17	17	20	21

GALVANIZED.

Code.....	Platinic	Platinise	Platkop	Platon	Platonis	Platrant
Size, inches.....	16x24	18x30	18x36	20x30	20x36	20x40
Depth, inches.....	6	6	6	6	6	6
Each, complete.....	\$2.70	3.55	4.30	4.30	5.10	5.90
Weight each, lbs.....	12	17	20	18	21	23

Furnished with Rubber Plugs, Plug Strainers or A Nipples when ordered, but charged extra. (See page 403.)

STEEL SINK BACKS.

15 inches high.

PAINTED.

Code.....	Platreur	Platschig	Plattbaum	Platteuse
Width, inches.....	24	30	36	40
Each.....	\$1.60	1.90	2.20	2.60
Weight each, lbs....	6	10	12	15½

GALVANIZED.

Code.....	Platfuss	Plattgarn	Platthin	Platlack
Width, inches.....	24	30	36	40
Each.....	\$2.20	2.60	3.00	3.50
Weight each, lbs....	6	12	14	15

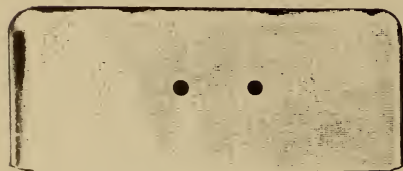

1495-C.

In Orders and Specifications give Plate Numbers and Sizes.

“COLUMBUS” WROUGHT STEEL PANTRY SINKS.

WITH IMPROVED BRASS COUPLING. FOR BUTLER'S PANTRY. INDESTRUCTIBLE. ODORLESS.

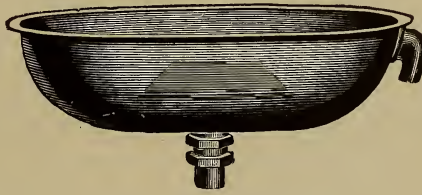

1496-C.

See pages 400 and 401 for description of Columbus Sinks.

OVAL.

With Common Overflow and Plugs with Rubber Stoppers.

Code.....	Platunio Painted	Plature White Enameled
Size, inches.....	14x20	14x26
Depth, inches.....	6	6
Each, complete.....	\$2.00	6.50
Weight each, lbs.....	9	9
Shipping measurement each, cubic feet.....	1	1

OBLONG. WHITE ENAMELED.

With Nickel-Plated Common Overflow and Plug with Rubber Stopper.

Code.....	Plaudit
Size, inches.....	16x24
Depth, inches.....	6
Each, complete.....	\$9.00
Weight each, lbs.....	14
Shipping measurement each, cubic feet.....	1 1/3

OVAL COPPER PANTRY SINKS.



1497-C.

Oval Copper Pantry Sink with Overflow and Waste Plug with Rubber Stopper.

TINNED AND POLISHED INSIDE. IMPROVED PATTERN.

Dishes cannot accumulate in center of Improved Pattern Oval Pantry Sinks to obstruct Waste Outlet.

Code.....	Plaudunt	Plausible	Plausore
Size, inches.....	14x20	16x24	18x30
Each, as described.....	\$7.50	10.00	13.00
Weight each, lbs.....	4 1/2	5 1/2	7 1/2

We can furnish Square Copper Pantry or Oval German Silver Pantry sinks in above sizes. (Prices on application.)

In Orders and Specifications give Plate Numbers and Sizes.

SOLID PORCELAIN LAUNDRY TRAYS.

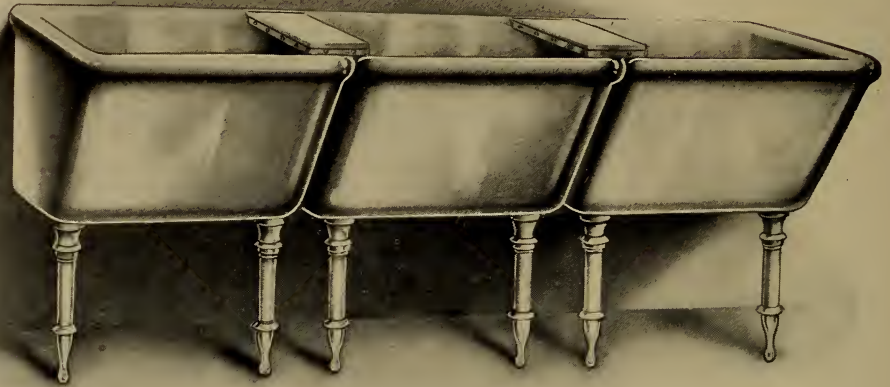

1500-C.

Solid Porcelain Roll Rim Laundry Trays, glazed pure white, with Bronzed Iron Legs; Nickel-Plated Waste Plugs and Couplings with Rubber Stoppers; Hardwood Wringer Attachments.

Dimensions of each Tray outside, 26x24x17 inches.

Code.....	Playada	Playazo	Playbill
Number of Trays.....	1	2	3
Length over all, inches.....	26	52	78
Complete as described.....	\$30.30	60.60	90.90
Shipping weight, lbs.....	260	520	780

Code.....	Playbook	Playday	Playful
Trays only.....	\$20.00	40.00	60.00

- Solid Porcelain Legs with Wall Supports, per pair, \$9.00
- Bronzed Iron Legs with Wall Supports, per pair, \$4.00.
- Galvanized Iron Standards complete, \$6.00.
- Galvanized Iron Legs, per pair, \$5.00.
- Iron Legs painted white, per pair, \$5.00.
- Brass Nickel-Plated Legs, per pair, \$10.00.
- Nickel-Plated Plugs and Couplings, each, \$1.30.
- Hardwood Wringer Attachment, Brass Bound, each, \$5.00.

In Orders and Specifications give Plate Numbers and Sizes

“LINCOLN” LAUNDRY TRAYS.

SEAMLESS, CLEAN, NON-ABSORBENT AND MORE DURABLE THAN IRON.

These Trays are carefully made of selected Clays and glazed in Light Yellow.



1502-C.

Lincoln Roll Rim Laundry Trays with Bronzed Iron Legs and Supports to Wall with Connecting Bar; Nickel-Plated Waste Plugs and Couplings with Rubber Stoppers; Ash Wringer Attachment.

Dimensions of each tray outside, 31x25x17.

Code.....	Playones	Playsome	Playtime
Number of trays.....	1	2	3
Length over all, inches.....	31	62	93
Complete as described.....	\$18.25	33.15	50.05
Code.....	Plazoleta	Plazuelas	Pledest
Trays only.....	\$12.50	25.00	37.50
Shipping weight, lbs.....	317	634	951

- Bronzed Iron Legs complete, each, \$2.00.
- Nickel-Plated Plugs and Couplings, each, \$1.25.
- Ash Wringer Attachment, each, \$0.65.
- Bar between Legs for one Tray, each, \$0.50.
- Bar between Legs for two Trays, each, \$1.00.
- Bars between Legs for three Trays, \$1.50.

These Trays can be furnished with cock holes if so desired.

In Orders and Specifications give Plate Numbers and Sizes.

“PLACER” LAUNDRY TRAYS.

SEAMLESS, CLEAN, NON-ABSORBENT AND MORE DURABLE THAN IRON.

These Trays are carefully made of selected Clays and glazed in Light Yellow.

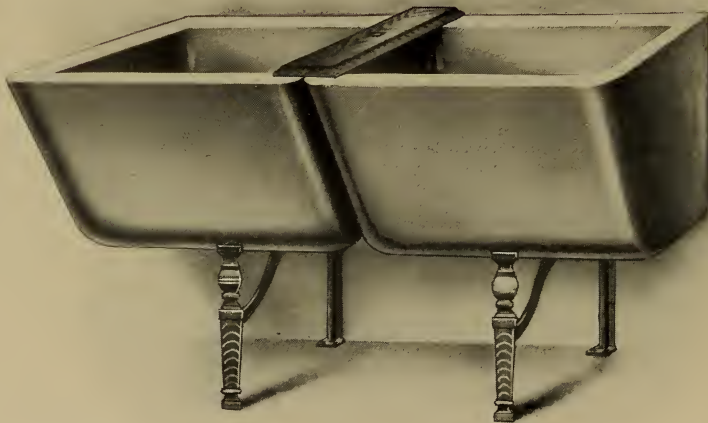

1504-C.

“Placer” Flat Rim Laundry Trays with Painted Iron Legs and Supports to Wall; Polished Brass Waste Plug and Coupling with Rubber Stopper; Pine Wringer Attachment.

Dimensions of each Tray outside, 25x22½x15 inches.

Code.....	Pleamar	Plebaglia	Plebamu
Number of Trays	1	2	3
Length over all, inches	25	50	75
Complete as described.....	\$9.80	18.00	27.20
Code.....	Plebano	Plebeity	Plebeizza
Trays only.....	\$6.50	13.00	19.50
Shipping weights, lbs.....	200	400	600

Painted Iron Legs with Wall Supports, each, \$1.00.

Polished Brass Plug and Couplings, each, \$1.00.

Pine Wringer Attachment, each, \$0.40.

Bar between Legs for one Tray, each, \$0.30.

Bars between Legs for two Trays, each, \$0.60.

Bars between Legs for three Trays, \$0.90.

These Trays can be furnished with cock holes if so desired.

In Orders and Specifications give Plate Numbers and Sizes.

PORCELAIN ENAMELED LAUNDRY TRAYS.



1506-C.

Porcelain Enameled Roll Rim Laundry Trays and 12-inch Porcelain Enameled Backs, Nickel Plated Union Strips and Hardwood Wringer Attachments, Painted Pedestals; Nickel Plated Soap Dishes; Nickel Plated Waste Plugs and Couplings, with Rubber Stoppers; Nickel Plated Fuller Wash Tray Bibbs and Flanges.

Code	Plebicole	Plebiscite	Plechtig
Number of Trays.....	1	2	3
Complete as described	\$25.50	47.00	70.50
Shipping weight, pounds.....	233	465	700

Code	Plectane	Plectibile	Plectique
Trays with Backs, Soap Dishes, Union Strips, Plugs and Pedestals, only.....	\$23.00	42.00	63.00

Nickel Plated Fuller Wash Tray Bibbs and Flanges, per pair, \$2.50.

Wringer not included in above prices.

Dimensions :

Front to back (inside), 21¼ inches; (outside), 27 inches; Length inside, 23 inches; Length over all (set of three trays), 83 inches; depth inside, 14¼ inches; height from floor to top of rim, 31½ inches.

In Orders and Specifications give Plate Numbers and Sizes.

PORCELAIN ENAMELED LAUNDRY TRAYS.



1508-C.

Porcelain Enameled Roll Rim Laundry Trays, with Nickel Plated Union Strips and Hardwood Wringer Attachments; Painted Pedestals; Nickel Plated Soap Dishes; Nickel Plated Waste Plugs and Couplings, with Rubber Stoppers; Nickel Plated Fuller Wash Tray Bibbs and Flanges.

Code.....	Pledgeor	Pledgery	Pledgaba
Number of Trays.....	1	2	3
Complete as described.....	\$22.50	41.00	61.50
Shipping weight, pounds.....	200	400	600
Code.....	Plegadizo	Pleguete	Pleister
Trays with Soap Dishes, Wringer Attachments, Union Strips, Plugs and Pedestals, only.....	\$20.00	36.00	54.00

Nickel Plated Fuller Wash Tray Bibbs and Flanges, per pair, \$2.50.

Wringer not included in above prices.

Dimensions :

Front to back (inside), 21¾ inches; (outside), 27 inches; length inside, 23 inches; length of three trays over all, 83 inches; depth inside, 14¾ inches; height from floor to top of rim, 31½ inches.

In Orders and Specifications give Plate Numbers and Sizes.

PORCELAIN ENAMELED WASH TRAYS.



1510-C.

Porcelain Enameled "Duplex" (Two Part) Flat Rim Wash Trays, cast in one piece, with 12-inch Porcelain Enameled Back and Nickel Plated Union Strips; Painted Iron Standards; Nickel Plated Soap Dishes; Nickel Plated Waste Plugs and Couplings with Rubber Stoppers; Nickel Plated Fuller Wash Tray Bibbs and Flanges.

Code.....	Pleitdag
Complete as described.....	\$36.50
Shipping weight, pounds.....	375
Code.....	Pleiteas
Duplex Trays with Backs, Standards and Plugs only.....	\$31.50
Shipping weight, pounds.....	300

If without Porcelain Enameled Backs, deduct \$6.00.

Nickel Plated Fuller Wash Tray Bibbs and Flanges, per pair, \$2.50.

Dimensions :

Front to back (inside), 21¾ inches; (outside), 25½ inches; length inside, 23 inches; length over all, 49¼ inches; depth inside, 14¾ inches; height from floor to top of rim, 31¼ inches.

In Orders and Specifications give Plate Numbers and Sizes.

PORCELAIN ENAMELED WASH TRAYS.

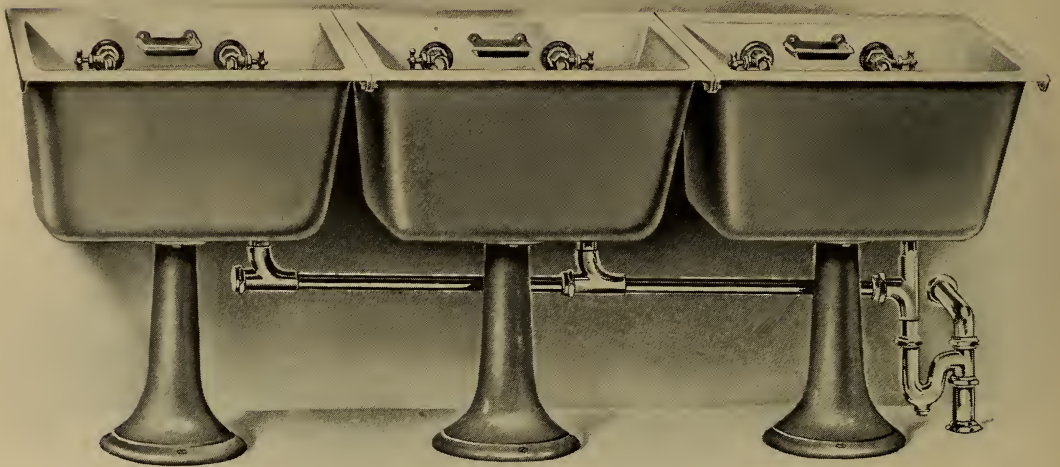

1512-C.

Porcelain Enameled Flat Rim Wash Trays, with Painted Pedestals; Nickel Plated Soap Dishes; Nickel Plated Waste Plugs and Couplings, with Rubber Stoppers; Nickel Plated Fuller Wash Tray Bibbs and Flanges; Nickel Plated Continuous Waste and Vented S Trap.

Code.....	Pleitrede	Plejaden	Plektron
Number of Trays.....	1	2	3
Complete as described.....	\$20.00	38.00	54.25
Shipping weight, pounds.....	230	460	690
Code.....	Plektune	Plektwant	Plektyel
Trays with Plugs and Soap Dishes only.....	\$11.00	22.00	33.00
Shipping weight, pounds.....	155	310	465

Nickel Plated Fuller Wash Tray Bibbs and Flanges, per pair, \$2.50.

Dimensions :

Front to back (inside), 22 inches; (outside), 25½ inches; length inside, 23 inches; length over all (set of three trays), 78 inches; depth inside, 14¼ inches; height from floor to top of rim, 31¼ inches.

In Orders and Specifications give Plate Numbers and Sizes.

IMPROVED CEMENT WASH TRAYS.



1514-C.

Cement Wash Trays, all in one piece, with polished Zinc Rims; each Tray cut for hot and cold water Wash Tray Bibbs; Plain or Galvanized Iron Legs; Waste Plug and Coupling, with Rubber Stopper.

All Trays are 24 inches wide and 16 inches deep.

ONE-PART TRAYS.

Code.....	Plenarily	Plendorum	Plenilune
Number.....	1	2	3
Length, inches.....	25	27	31
Each, without legs.....	\$6.50	7.50	8.50
Shipping weight, pounds.....	225	235	250

TWO-PART TRAYS.

Code.....	Plenipos	Plenitas	Plentude
Number.....	4	5	6
Length, inches.....	48	54	60
Each, without legs.....	\$11.50	12.50	13.50
Shipping weight, pounds.....	450	475	510

THREE-PART TRAYS.

Code.....	Plenitum	Pleomazie	Pleonastic
Number.....	7	8	9
Length, inches.....	72	80	90
Each, without legs.....	\$21.00	22.00	23.00
Shipping weight, pounds.....	670	700	760

For Plain Iron Legs, add \$0.75 each.

For Galvanized Iron Legs, add \$1.50 each.

For Wood Covers, add \$1.50 each.

These Trays are made of the best Portland Cement, the Concrete is of uniform thickness, and is thoroughly pressed. They have rounded rims of heavy Zinc, and the corners in Trays are rounded inside and out.

In Orders and Specifications give Plate Numbers and Sizes.

H. M. & S. GALVANIZED STEEL WASH TRAYS.

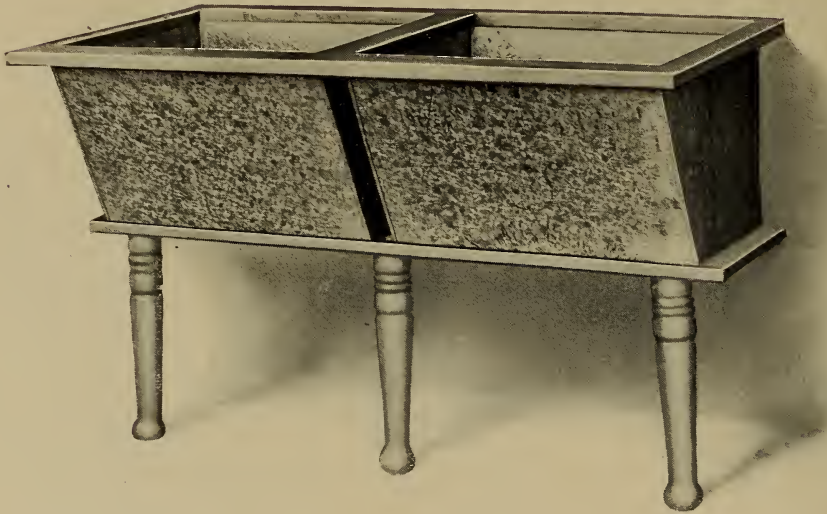

1516-C.

Galvanized Steel Wash Trays, with Plain Wood Rim, Turned Legs and Bottom Boards.

Size of each Tray inside: Width, 22 inches; length, 23 inches; depth, 14 inches; height from floor to top of rim, 32 inches; width over all, 27½ inches.

Code.....	Pletorica	Plettro	Pletwerk
Number of Trays, complete as described.....	1	2	3
Length, over all, inches.....	26½	54	80½
Each.....	\$3.15	5.30	8.05
Shipping weight, pounds.....	21	42	63
Shipping measurement, cubic feet.....	7	14	21

Code.....	Pleurard	Pleuricos	Pleuvant
Each, without Legs.....	\$2.95	5.00	7.65

These Trays are made of heavy galvanized steel, securely fastened to the wood rim, the front edge of each Tray is set into the under side of the wood rim, thus preventing water from splashing out between Tray and rim. The rim and bottom board are held together with iron rods.

In Orders and Specifications give Plate Numbers and Sizes.

PORCELAIN ENAMELED SLOP SINKS.



1520-C.

Porcelain Enameled Inside Roll Rim Slop Sink, with 15-inch Porcelain Enameled Back, on Trap Standard with Cleanout and 2-inch Nickel Plated Vent Connection to Wall; Nickel Plated Strainer; Nickel Plated Fuller Bibbs and Flanges.

Code.....	Plexaure	Plexerunt	Plexiform	Plexibilus	Plexilis
Size, inches.....	16x20	18x22	20x22	20x24	20x30
Complete as described.....	\$18.50	20.50	21.50	22.50	26.00
Shipping weight, pounds.....	117	128	132	140	165
Code.....	Plexilium	Plexisti	Plexo	Plexuisse	Plexuram
If Enameled all over, add.....	\$5.00	5.00	5.50	5.50	6.00

If without Nickel Plated Bibbs and Flanges, deduct, per pair, \$2.50.

If with Concealed Galvanized Air Chambers, add, per pair, \$2.00.

In Orders and Specifications give Plate Numbers and Sizes.

PORCELAIN ENAMELED SLOP SINK.



† 1521-C.

Porcelain Enameled Inside Roll Rim Slop Sink, with 15-inch Porcelain Enameled Back and Right Hand End Piece, on Trap Standard with Cleanout and 2-inch Nickel Plated Vent Connection to Wall; Nickel Plated Strainer; Nickel Plated Fuller Bibbs and Flanges.

Code.....	Pliancy	Pliasses	Plicabar	Plicandos	Plicate
Size, inches.....	16x20	18x22	20x22	20x24	20x30
Complete as described.....	\$20.50	22.50	23.50	24.50	28.00
Shipping weight, pounds.....	167	180	193	210	220
Code.....	Plicatif	Plicatule	Plichten	Pliform	Plighted
If Enameled all over, add.....	\$5.00	5.00	5.50	5.50	6.00
Shipping weight, pounds.....	200	220	230	236	245

If without Nickel Plated Bibbs and Flanges, deduct, per pair, \$2.50.

If with Concealed Galvanized Air Chambers, add, per pair, \$2.00.

† Carried in San Francisco only.

In Orders and Specifications give Plate Numbers and Sizes.

PORCELAIN ENAMELED SLOP SINK.

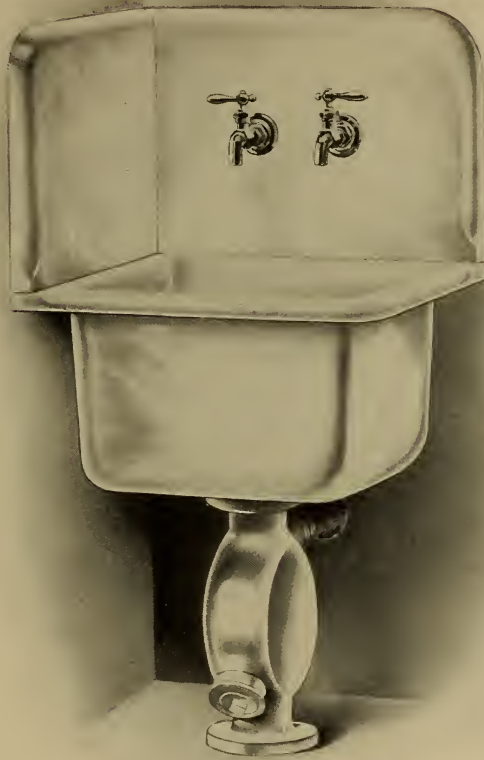

† 1522-C.

Porcelain Enameled Inside Roll Rim Slop Sink, with 15-inch Porcelain Enameled Back and Left Hand End Piece on Trap Standard, with Cleanout and 2-inch Nickel Plated Vent Connection to Wall; Nickel Plated Strainer; Nickel Plated Fuller Bibbs and Flanges.

Code.....	Plinthos	Plintote	Plipiabo	Plisimi	Plistinus
Size, inches.....	16x20	18x22	20x22	20x24	20x30
Complete as described.....	\$20.50	22.50	23.50	24.50	28.00
Shipping weight, pounds.....	167	180	193	210	220

Code.....	Ploccano	Ploccasse	Plochions	Plodebare	Plodendos
If Enameled all over, add.....	\$5.00	5.00	5.50	5.50	6.00
Shipping weight, pounds.....	200	220	230	236	245

If without Nickel Plated Bibbs and Flanges, deduct, per pair, \$2.50.

If with Concealed Galvanized Air Chambers, add, per pair, \$2.00.

† Carried in San Francisco only.

In Orders and Specifications give Plate Numbers and Sizes.

PORCELAIN ENAMELED SLOP SINK.



1524-C.

Porcelain Enameled Inside Slop Sink, with Roll Rim on all sides, on Trap Standard with Cleanout and 2-inch Nickel Plated Vent Connection to Wall; Nickel Plated Strainer.

Code.....	Plodimus	Plomados	Plomazon	Plombada
Size, inches.....	16x20	18x22	20x22	20x24
Complete as described.....	\$14.00	16.00	17.00	18.00
Shipping weight, pounds.....	92	100	122	126

Code.....	Plombeurs	Plombiez	Plombique	Plombons
If Enameled all over, add.....	\$5.00	5.00	5.50	5.50

If with Nickel Plated Fuller Combination Slop Sink Cock,
with Bucket Hook and Wall Support, add \$7.00.

In Orders and Specifications give Plate Numbers and Sizes.

SQUARE SLOP SINK.



1526-C.

Porcelain Enameled Flat Rim Square Slop Sink, with End Outlet, Nickel Plated Strainer and Coupling for Lead Pipe.

PORCELAIN ENAMELED INSIDE, PAINTED OUTSIDE.

Code	Plomizo	Plomosos	Plonged	Plongeur	Plonnure	Ploquer
Size, inches.....	16x16x10	20x16x12	22x20x12	24x20x12	†30x20x12	†36x20x12
Outlet, inches.....	2	2	2	4	4	4
Each.....	\$4.50	6.00	6.90	7.25	10.50	12.75
Weight each, pounds.....	41	51	80	85	105	124

PAINTED INSIDE AND OUTSIDE.

Code	Plorabo	Plorabunt	Plorandus	Plorarem
Size, inches.....	16x16x10	20x16x12	22x20x12	24x20x12
Outlet, inches.....	2	2	2	4
Each.....	\$2.70	4.00	4.50	5.00
Weight each, pounds.....	36	46	75	78

† Carried in San Francisco only.

In Orders and Specifications give Plate Numbers and Sizes.

GREASE TRAPS.



1528-C.

Cast Iron Grease and Sewer Traps, Painted inside and out, with Brass Hand Hold Cover.

Code.....	Plorator
Each.....	\$7.00
Weight each, pounds.....	80

Dimensions :

Diameter, 16½ inches; height, 13 inches.

Cast Iron Porcelain Enameled Inside Grease Trap, with Polished Brass Inlet and Outlet Connections, with Removable Top and Swivel Bolts.

Code.....	Ploravero
Each.....	\$13.00
Weight each, lbs.	69

Can also be furnished Enameled all over with Nickel Plated Trimmings.

Dimensions :

Body, 10 inches square, 10 inches deep; connections, 1½ inches.

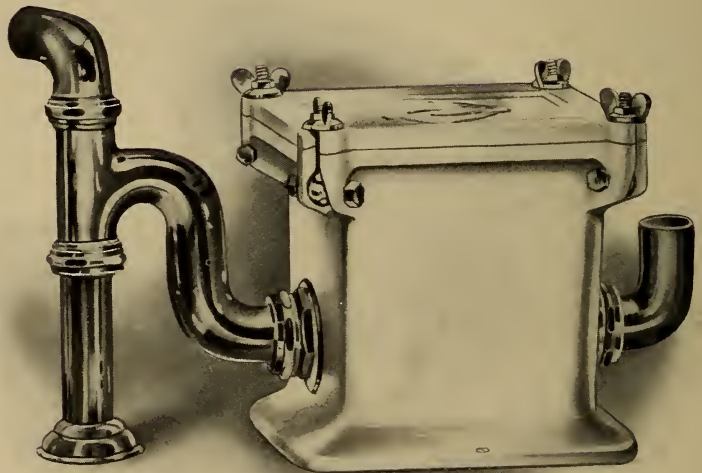

1529-C.

GREASE TRAP.

NICKEL-PLATED BRASS.



† 1530-C.

Dimensions:

Body of trap, 10 inches high; diameter, 5 inches; connections, 2 inches.

Code.....	Ploravit
Each.....	\$18.00
Shipping weight each, lbs.....	38
Net weight, lbs.....	23

IRON STONE GLAZED GREASE TRAP.

WITH REMOVABLE COVER.

Use 3-inch Iron Stone Sewer Pipe to connect Grease Traps with the lateral sewer. Inside diameter of Inlet and Outlet, 3 inches.

Code.....	Plostella	Plostrabor
Number	1	2
Inside diameter, inches.....	12	16
Depth, inches.....	13	18
Capacity, gallons.....	3	7
Each	\$4.00	5.00
Weight each, lbs.....	40	66

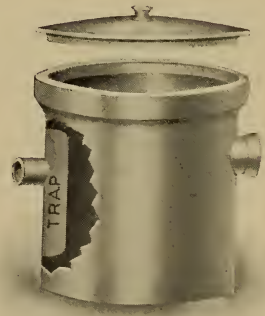

1531-C.

† Carried in San Francisco only.

In Orders and Specifications give Plate Numbers and Sizes.

GREASE INTERCEPTORS.

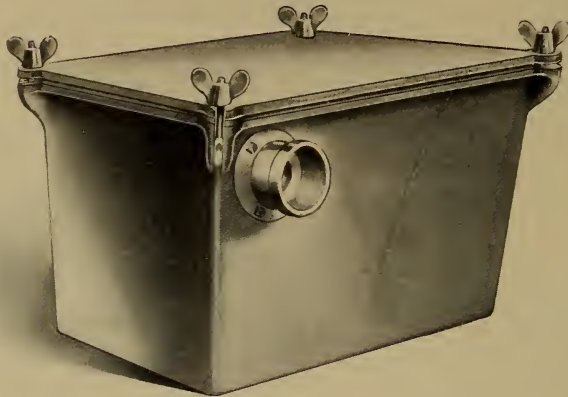

† 1532-C.

Cast Iron, Painted Inside and Outside Grease Interceptor, with 4-inch Hub Inlet and Outlet, Brass Clamps and Heavy Rubber Disc.

Code.....	Plotful	Plotium
Numbers	1	3
Size, inches.....	21x18	31½x21½
Depth, inches.....	18	18½
Each.....	\$25.00	37.50
Weight each, lbs.....	267½	378

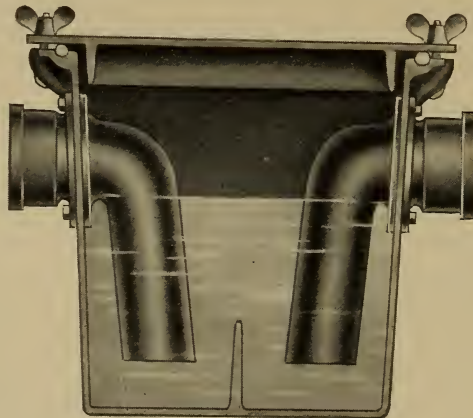

Sectional View of 1532-C.

The above is designed for Hotels and large Private Establishments where there is a large amount of grease passing through the pipes, Kitchen, Butler's Pantry or Scullery Sinks; it is intended to be placed at some convenient point where the Main Pipe from all the Sinks can be connected. By reference to sectional cut it can readily be seen how the fatty matter can be disintegrated and intercepted, first by dropping into a large body of cold water, then by being driven against the center partition before an outlet can be gained. The specific gravity of the fat naturally carries it to the surface in a chilled condition, where it collects to be removed as often as may be necessary. The Inlet and Outlet are placed at one end of the box in order to leave a large space comparatively undisturbed for the accumulation of fat or grease.

† Carried in San Francisco only.

In Orders and Specifications give Plate Numbers and Sizes.



† 1536-C.

MARQUIS PATTERN SLOP HOPPER.

WITH STRAINER AND BELL TRAP. REMOVABLE BASKET.
PAINTED IRON.

Code, 2-inch outlet.....	Plantage
Code, 4-inch outlet.....	Plovebat
Each	\$2.40
Weight each, pounds.....	20

Dimensions :

Diameter at top, 13½ inches; depth of basket, 9½ inches;
height from floor to top of rim, 12¾ inches.



1537-C.

BAILEY PATTERN SLOP HOPPER.

WITH BELL TRAP. REMOVABLE BASKET. PAINTED
IRON.

Code.....	Ploxema
Diameter, inches	13
Each.....	\$5.00
Weight each, pounds.....	64

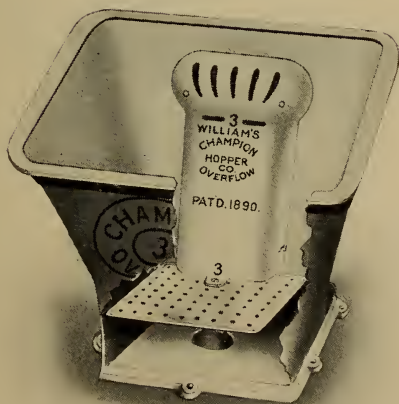

1538-C.

CHAMPION OVERFLOW HOPPERS.

WHITE ENAMELED INSIDE AND ON TOP OF RIM.
REMOVABLE PATENT OVERFLOW
AND STRAINER.

2-inch Outlet.

Code.....	Plucheux	Pluchia	Pluchon
Numbers	1	2	3
Top, inches.....	13x15½	12x14	11x12
Height, inches	14	12	11
Each.....	\$4.25	4.00	3.75
Weight each, pounds...	35	30	25

† Carried in San Francisco only.

In Orders and Specifications give Plate Numbers and Sizes.

“MENLO” SLOP HOPPERS.

PAINTED IRON, REMOVABLE STRAINERS, WITH OR WITHOUT BELL TRAPS.



1540-C.

Style of Nos. 1, 2, 3.



1541-C.

Styles of Nos. 4, 5.

MENLO SLOP HOPPERS, WITH STRAINERS AND BELL TRAPS.

Code, 2-inch outlet.....	Plumabor	Plumagem	Plumajear	Plumassar	Plumatelle
Code, 3-inch outlet.....	Plumatoris	Plumaturo	Plumaverit	Plumazas	Plumazone
Code, 4-inch outlet.....	Plumbando	Plumbavit	Plumbeas	Plumbeo	Plumbery
Number.....	1-T.	2-T.	3-T.	4-T.	5-T.
Each.....	\$2.40	2.20	1.80	1.50	1.20
Weight each, pounds.....	26	21	18	15	12

MENLO SLOP HOPPERS, WITH STRAINERS ONLY.

Code, 2-inch outlet.....	Plumesco	Plumicolle	Plumicorn	Plumifera	Plumigene
Code, 3-inch outlet.....	Plumiped	Plumipedi	Plumitarse	Plummet	Plumosite
Code, 4-inch outlet.....	Plumotage	Plumoter	Plumpsen	Plumula	Plumuleux
Number.....	1	2	3	4	5
Each.....	\$2.40	2.20	1.80	1.50	1.20
Weight each, pounds.....	22	18	16	12	10

EXTRAS FOR MENLO SLOP HOPPERS.

Numbers.....	1	2	3	4	5
Strainers with Bell Traps.....	\$.60	.60	.60	.50	.50
Strainers only.....	.40	.40	.40	.30	.30

Dimensions :

- No. 1, length, 14 inches; width, 13 inches; height, 13 inches.
- No. 2, length, 13½ inches; width, 12 inches; height, 11½ inches.
- No. 3, length, 13 inches; width, 11 inches; height, 10 inches.
- No. 4, length, 10½ inches; width, 9¾ inches; height, 9¾ inches.
- No. 5, length, 9¼ inches; width, 8¾ inches; height, 6½ inches.

Made with 2, 3, or 4-inch outlets.

In Orders and Specifications give Plate Numbers and Sizes.

CESSPOOLS.

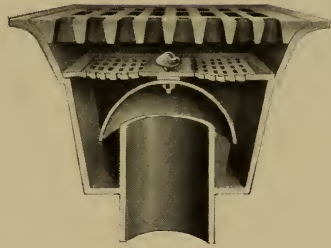

1544-C.

Sectional of 1544-C.

EXTRA HEAVY SQUARE STABLE CESSPOOL WITH BELL TRAP AND REMOVABLE TOP GRATING ;
PAINTED.

Code	Plungeon	Plupart
Size, inches.....	12x12	16x16
Depth, inches.....	10	10
Outlet, inches.....	3	4
Each	\$3.75	4.50
Weight each, lbs.....	28	56



1546-C.

CESSPOOL WITH BELL TRAP AND ROUND
HINGED GRATING.

Code.....	Pluquet	Plural
Size, inches.....	9x9	13x13
Outlet, inches.....	3	4
Each.....	\$1.35	2.50
Weight each, lbs.....	13	18



1548-C.

CESSPOOL WITH BELL TRAP AND SQUARE
GRATING.

Code.....	Plurales
Size, inches.....	15x15
Outlet, inches.....	4
Each.....	\$2.00
Weight each, lbs.....

In Orders and Specifications give Plate Numbers and Sizes.

STENCH TRAP.

FLOOR DRAIN WITH TRAP.



1550-C.

STENCH TRAP WITH HINGED STRAINER AND BELL.

Code.....	Pluralize
Size, inches.....	6x6
Outlet, inches.....	2
Each.....	\$1.00
Weight each, lbs.....	6

1552-C.

CAST BRASS FLOOR DRAIN WITH TRAP.

Code.....	Pluranio
Diameter of Top, inches.....	9
Depth, inches.....	8
Outlet, inches.....	2
Each.....	\$10.00
Weight each, lbs.....	13

Polished top. Outlet threaded for iron pipe.

HYDRANT CESSPOOLS.

SURFACE DRAINS.

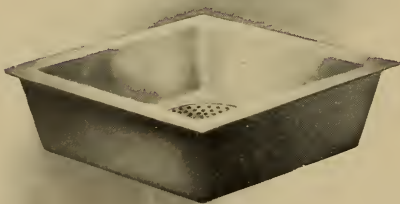

† **1554-C.**

HYDRANT CESSPOOL WITH STRAINER; PAINTED INSIDE.

Code.....	Pluribus	Plurielle	Plurigam
Size, inches.....	12x12x6	14x14x6	16x16x6
Each.....	\$1.00	1.25	1.50
Weight each, lbs...	13	16	20

1556-C.

SURFACE DRAINS WITH HINGED COVER. NO BELL.

Code.....	Plurilobe	Plurilute
Size, inches.....	6x6	9x9
Each.....	\$0.75	1.00
Weight each, lbs.....	5½	12

† Carried in San Francisco only.

In Orders and Specifications give Plate Numbers and Sizes.

CESSPOOL PLATES.



1558-C.
Square Cesspool Plate
with Holes.

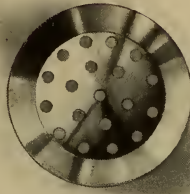

1559-C.
Round Cesspool Plate
with Holes.



1560-C.
Square Cesspool Plate
with Bars.

SQUARE CESSPOOL PLATES WITH HOLES, 1558-C.

Code.....	Plurimos	Plurioyule	Pluriserie	Plurivalve
Size, inches.....	6x6	8x8	10x10	12x12
Each.....	\$0.30	.60	.80	1.00
Weight each, pounds.....

ROUND CESSPOOL PLATES WITH HOLES, 1559-C.

Code.....	Plusage	Plusculos	Pluseuse	Plusimo
Diameter, inches.....	6	8	10	12
Each.....	\$0.30	.60	.80	1.00
Weight each, pounds.....

SQUARE CESSPOOL PLATES WITH BARS, 1560-C.

Code.....	Plussiez	Plutarcho	Plutarque	Pluteum	Plutonian	Plutoribus	Pneumat
Size, inches.....	6x6	6x8	8x8	10x10	12x12	14x14	16x16
Each.....	\$0.30	.50	.60	.80	1.00	1.20	1.50
Weight each, pounds	3

VENTILATING BOXES.

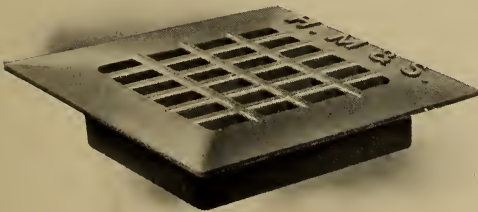

1561-C.
A Solid Box Grating and Frame,
all in one Piece.

Code.....	Pneumatage
Size, inches.....	8½x8½
Each.....	\$1.00
Weight each, pounds.....	8¾

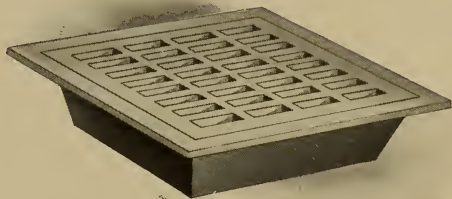

1562-C.
Ventilating Boxes with Removable
Grates.

Code.....	Pneumatell
Size, inches.....	15¼x15¼
Each.....	\$4.00
Weight each, pounds.....	34

In Orders and Specifications give Plate Numbers and Sizes.

STREET WASHER BOXES.

PLAIN CAST IRON.



1564-C.

Code	Pneumatico
Size, inches.....	10x10
Each	\$1.20
Weight each, pounds.....	10

SIDEWALK BOXES.

PLAIN CAST IRON.



1566-C.

Sidewalk Box with Solid Chained Cover.

Code.....	Pneumatod	Pneumique	Pneumores
Size, inches...	8x8	9½x9½	12x12
Each.....	\$0.80	1.20	2.00
Wt. each, lbs.,	6½	8½	15

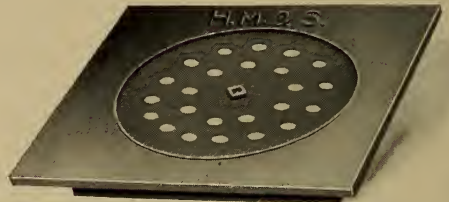

1567-C.

Sidewalk Box with Perforated Chained Cover.

Code.....	Pneumose	Pniglion	Pnigeos
Size, inches.....	8x8	9½x9½	12x12
Each.....	\$0.80	1.20	2.00
Wt. each, lbs.....	6	8	13½

SIDEWALK BOX COVERS.

SOLID OR PERFORATED.

Code for Solid.....	Pnigite	Pnigitis	Pocite
Code for Perforated	Pobeda	Poblacho	Pobladas
Size, inches.....	4¾	6¼	8¾
Fits Boxes, inches.....	8x8	9½x9½	12x12
Each	\$0.25	.35	.60
Weight each, pounds.....	1¼	2	4¾

In Orders and Specifications give Plate Numbers and Sizes.

SECTION 6.

RANGE BOILERS,

WATER BOILERS,

WATER HEATERS

AND RADIATORS.

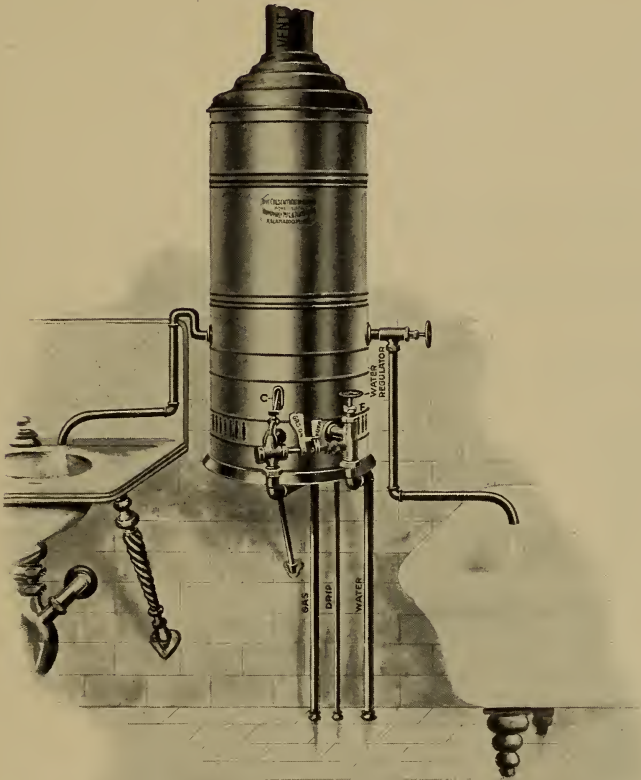

HOLBROOK, MERRILL & STETSON,

INCORPORATED.

SAN FRANCISCO, LOS ANGELES AND NEW YORK.

RANGE BOILERS, WATER HEATERS, ETC.

Electric Weld Range Boilers are the best that genius and modern mechanical devices can produce.

Water Boilers and Heaters shown on the following pages are of the most approved and salable designs, but we can furnish on short notice many other styles and sizes.

Radiation shown is carried in stock and we are prepared to furnish other styles and heights.

In ordering goods from this section by telegraph it is only necessary to use the code word over or opposite the number or name of the article wanted preceded by words from the code in front of this book.

Example: Crogmar one Pobretao and Podometre.

Translation: Ship via quickest route one thirty-gallon galvanized boiler and adjustable stand.

ELECTRIC WELD GALVANIZED RANGE BOILERS.

Electric Welding has entirely superceded the older methods, because it does absolutely perfect work. This fact has been long recognized by engineers, the only obstacles being the ingenuity, experimental work and great outlay required to adapt this wonderful agent to the work in hand.

Realizing the weakness of the riveted seam in Range Boiler Construction, we cast about for a Boiler improved at this vital point, and finally, after exhaustive investigation, convinced ourselves that Electric Welding would settle the question beyond all dispute, with the result that we are furnishing a boiler that is practically a seamless tube, stronger and more dependable than a piece of pipe, or a seamless drawn tube, as the weld is stronger than the body of the sheet by reason of its greater sectional area and the gauge of the plate is uniform, which is not the case in a drawn tank or tube.

The heads and bottoms are made a trifle larger in diameter than the shell, the end of which is expanded by heating in a furnace; the head or bottom then put in, the shell shrinking down to an absolute iron to iron fit in cooling, the heads and bottoms are then riveted just as securely as in any other boiler; this insures the plumber that when he gets a boiler he can depend upon its being tight.

The gauges of the material entering into the construction of Electric Weld Boilers are equally as heavy and in some instances heavier than those used for riveted boilers.

A Standard Electric Weld Boiler will not weigh as much as some of the riveted boilers of same capacity for these reasons: In the first place, there are no rivets in the side seam, which saves about three pounds in weight; next, the plates are from one and one-half to two and one-half inches shorter, as there is no lap required for riveting, saving from two to three pounds more; finally, the side seams do not have to be brazed, saving another pound in brass, or a total saving of from six to seven pounds in weight, that adds no value to the wearing qualities or life of the boiler. In other words, if the average weight of the 30-gallon Standard Electric Weld Boiler is 70 pounds, it would be equal to about a 75-pound riveted boiler.

The Electric Weld Boiler is **not** a cheap one. It costs more than any other to build, but it is the **best** and most dependable boiler made. It is stronger and will test to pressures that would tear a riveted boiler apart.

Electric Weld Boilers are made in sizes up to and including 63 gallons. Larger sizes are riveted and brazed with hard brass solder, making the best possible construction in riveted boilers.

We guarantee these Boilers against defects either in material or construction, and will cheerfully replace any goods failing from these causes if used under conditions for which they are recommended.

Showing Electric Weld Seam.

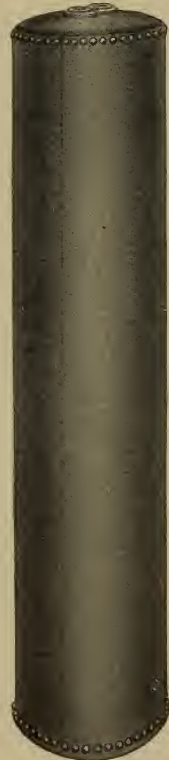

ELECTRIC WELD GALVANIZED RANGE BOILERS.

STANDARD. 200 POUNDS TEST. GUARANTEED FOR ONE YEAR UNDER MAXIMUM WORKING PRESSURE OF 80 POUNDS.



1600-C.

Code.	Capacity, Gallons.	Diameter, Inches.	Height, Feet.	Tapped, Inches.	Shipping Weight, Lbs.	Shipping Measurement, Cubic Feet.	Each.
Pobles.....	18	12	3	1	47	2 1/3	\$ 14.50
Poblicum.....	21	12	3 1/2	1	49	2 2/3	15.50
Poblilia.....	24	12	4	1	57	3	15.75
Pobretao.....	30	12	5	1	70	4	19.00
Pobretar.....	40	14	5	1	86	5 1/3	24.00
Pobreza.....	52	16	5	1 or 1 1/4	128	7	31.00
Pobrismo.....	53	18	4	1 or 1 1/4	128	7	31.50
Pocharder.....	63	16	6	1 or 1 1/4	122	8 1/2	38.00
Pochbrett.....	66	18	5	1 or 1 1/4	150	9	38.00
Pochereth.....	82	20	5	1 1/4 or 1 1/2	177	11	45.50
Pocherz.....	100	22	5	1 1/4 or 1 1/2	185	13 1/3	63.50
Pochettes.....	120	24	5	1 1/2	265	16	72.50
Pochetto.....	144	24	6	1 1/2	332	19	103.00
Pochouses.....	192	24	8	1 1/2	391	57 1/3	132.00

Electric Weld Boilers are made in all sizes up to and including 63 gallons.

Larger sizes are riveted and brazed.

In Orders and Specifications give Plate Numbers and Sizes.

ELECTRIC WELD GALVANIZED RANGE BOILERS.

EXTRA HEAVY, 250 POUNDS TEST.

Guaranteed for one year under maximum working pressure of 150 pounds.

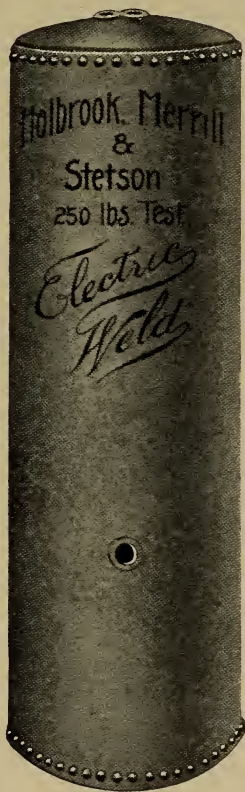

1601-C.

Code.	Capacity, Gallons.	Diameter, Inches.	Height, Feet.	Tapped, Inches.	Shipping Weight, Lbs.	Shipping Measurement, Cubic Feet.	Each.
Pochgang.....	30	12	5	1	90	4	\$19.00
Pochhaus	40	14	5	1	113	5 $\frac{1}{3}$	24.00
Pochjunge	52	16	5	1 or 1 $\frac{1}{4}$	155	7	31.00
Pochmehl.....	66	18	5	1 or 1 $\frac{1}{4}$	181	9	38.00
Pochrolle	82	20	5	1 $\frac{1}{4}$ or 1 $\frac{1}{2}$	205	11	45.50
Pochspel.....	100	22	5	1 $\frac{1}{2}$	265	13 $\frac{1}{3}$	63.50

Electric Weld Boilers are made in all sizes up to and including 63 gallons. Larger sizes are riveted and brazed.

In Orders and Specifications give Plate Numbers and Sizes.

HORIZONTAL GALVANIZED RANGE BOILERS.

DOUBLE RIVETED AND BRAZED.



1603-C.

Tapped as required. Tested to any pressure. Sizes and lists same as given on page 432. Prices on application.

LARGE GALVANIZED BOILERS OR HOT WATER TANKS.

For Flats, Hotels, Apartment Houses, Office Buildings, Etc.
Made in all shapes and sizes.

Code.	Capacity, Gallons.	Diameter, Inches.	Height, Feet.	Shipping Weight, Lbs.	Shipping Measurement, Cubic Feet.	Each.
Pockengift.....	120	24	5	490	16	Prices upon Application.
Pockenholz.....	145	24	6	560	19	
Pocketed.....	170	24	7	660	22½	
Pocketful.....	180	30	5	660	25	
Pocketing.....	215	30	6	740	30	
Pockmark.....	250	30	7	840	35	
Pockwood.....	300	30	8	940	40	
Podaban.....	325	36	6	940	43⅙	
Podagra.....	365	36	7	1040	50½	
Podagroso.....	420	36	8	1140	57½	
Podagrous.....	430	42	6	1240	59	
Podarges.....	575	42	8	1500	78½	
Podasteis.....	720	42	10	1700	98	
Podaxon.....	940	48	10	2000	128	

Tapped as required. Tested to any pressure. Handholes or manholes furnished when desired, at extra cost.

BOILER RINGS.

PLAIN CAST IRON.

Tapped for Iron Pipe.

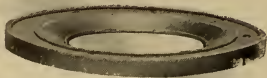

1605-C.

Code.....	Podabusck	Podengo	Poderale	Podestat	Podetion	Podiceps	Podiebrad
For boilers, gallons.....	18 to 30	40	52 to 63	66	82	100	120 to 192
Size, inches.....	12	14	16	18	20	22	24
Tapped for pipe, inches.....	½	½	1	1	1	1	1
Each.....	\$0.35	.55	1.40	1.75	2.35	3.00	4.25
Weight each, lbs.....	3	7	11	16	20	27	41

In Orders and Specifications give Plate Numbers and Sizes.

BOILER STANDS.



1606-C.

Lockwood's Improved. Plain Cast Iron.

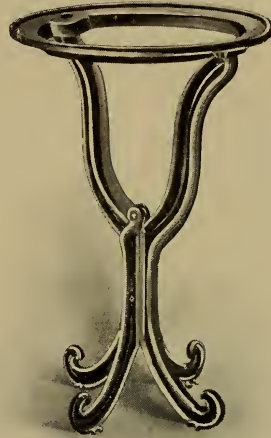

1607-C.

Modern Adjustable. Plain Cast Iron.

LOCKWOOD'S IMPROVED BOILER STANDS—1606-C

Code	Podismabo	Podismes	Podisome	Podocarlo	Podochilo	Podology	Podomales
Size of boiler, gallons.....	18, 21, 24 or 30	40	52, 53 or 63	66	82	100	120, 144 or 192
Size of ring, inches.....	12	14	16	18	20	22	24
Height, inches.....	19	19	19	22	23	23	24
Each	\$1.25	1.40	1.75	2.00	2.25	2.50	3.00
Shipping weight, lbs.....	11	12	21	21	27	35

MODERN ADJUSTABLE BOILER STAND—1607-C.

The adjustable Side Arms allow of the setting of Stand level on floor without blocking.

Code.....	Podometre	Podonties
Size of boiler, gallons.....	18, 21, 24 or 30	40
Size of ring, inches.....	12	14
Height, inches.....	19	19
Each	\$1.25	1.40
Shipping weight, lbs.....	11	12



1608-C.

MENLO BOILER STANDS.

Plain Cast Iron.

Tapped for 1¼-inch Iron Pipe.

Code	Podophule	Podopses
Size boiler, gallons.....	30	40
Size of ring, inches.....	12	14
Each.....	\$1.50	2.00
Shipping weight, lbs.....	12	15

Price includes ring, yoke and base.

In Orders and Specifications give Plate Numbers and Sizes.

LAWSON GAS WATER HEATERS.

FOR HEATING WATER WITH NATURAL OR MANUFACTURED GAS.

To be Used in Connection with an Ordinary Range Boiler.



1630-C.

Showing Design for Manufactured Gas.

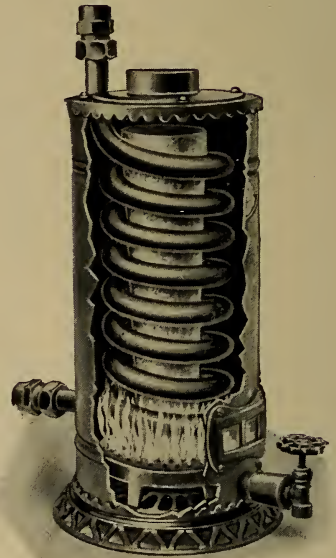

1631-C.

Showing Design for Natural gas.

The interior construction of Heater for Natural or Manufactured Gas is the same.

A coil of best seamless drawn copper tubing provides ample heating surface and possesses many advantages over cast iron devices, iron pipes, etc. Not only being a better heat conductor, but reducing the number of water joints to a minimum. It can be readily connected to any domestic boiler without using special connections or fittings. Each heater is fitted with ground-joint brass unions. The conical deflector forces the flames and heated air to circulate close to the coil and prevents down-draft. The jacket is lined with asbestos, which prevents the escape of heat. Either Russia Iron or Copper Jackets can be supplied. The top and bottom are cast iron.

The burners produce maximum heat with minimum gas consumption.

FOR MANUFACTURED GAS WITH RUSSIA IRON JACKET.

Code	Poetiche	Poeticos	Poeticule	Poetisch
Numbers.....	1	1½	2	3
Diameter, inches.....	8	8	8	8
Height, inches	15	18	20	24
Tube, inches.....	¾	¾	¾	¾
Capacity, gallons.....	30	30 to 40	40 to 50	50 to 100
Each.....	\$12.50	15.00	20.00	30.00
Shipping weight each, lbs.....	16	20	23	36

FOR NATURAL GAS WITH RUSSIA IRON JACKET.

Code.....	Poetry	Poetship
Numbers	†0	†1
Diameter, inches.....	8	8
Height, inches.....	12½	15
Tube, inches.....	¾	¾
Capacity, gallons.....	30	32
Each.....	\$10.00	12.50
Shipping weight, lbs.....	14	16

One in a crate.

† Carried in San Francisco only.

In Orders and Specifications give Plate Numbers and Sizes.

LAWSON THERMOSTATIC VALVE.

FOR NATURAL OR MANUFACTURED GAS.

Code.....	Poggiando	Poggiassi
Style	Manufactured Gas	† Natural Gas
Size, inch.....	½	¾
Each.....	\$9.00	7.00
Weight each, lbs....	6½	3



1632-C.

LAWSON THERMOSTATIC VALVE.

Many gas water-heaters waste more gas than is necessary to heat the water.

Servants neglect to turn down the gas when the water in the boiler has been heated to the required temperature.

The Lawson Thermostatic Valve not only turns off the gas when the water has been heated, but turns it on again when the temperature falls below the desired point.

It may be set to turn the gas on or off at any temperature, and be attached to the Lawson Heater for natural or manufactured gas. No pilot light is used—simply a small by-pass valve, which can be adjusted to allow a small flame to burn when the main valve is closed.

By this method, the heat usually wasted by the pilot light is utilized by being conveyed to the burner, thus keeping the water in the boiler hot.

The saving of gas effected by this device will pay for it in a short time.

† Carried in San Francisco only.

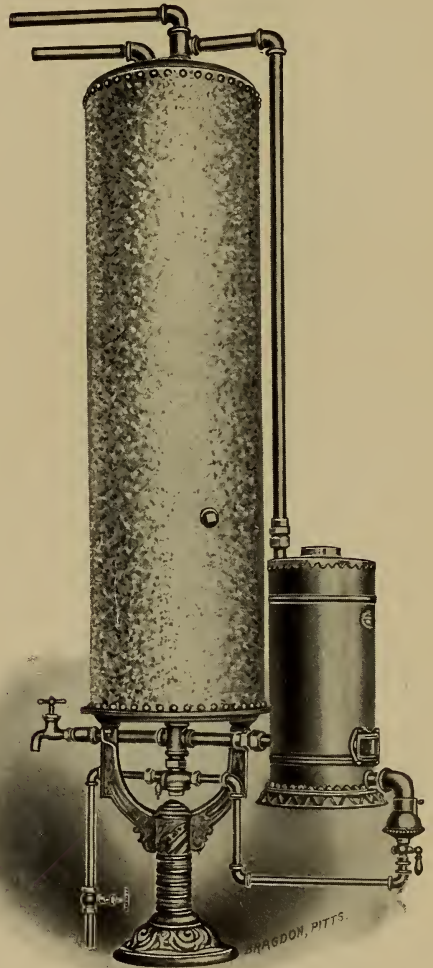

1633-C.

Showing proper way to connect the Lawson Gas Water-heater and Thermostatic Valve to Boiler for either Natural or Manufactured Gas, placing the Thermostatic Valves in the bottom of the Boiler.

In Orders and Specifications give Plate Numbers and Sizes.

INTERNATIONAL DOMESTIC WATER HEATERS.

John's Patent.

FOR USE ON ANY STOVE OR RANGE IN CONNECTION WITH A RANGE BOILER.

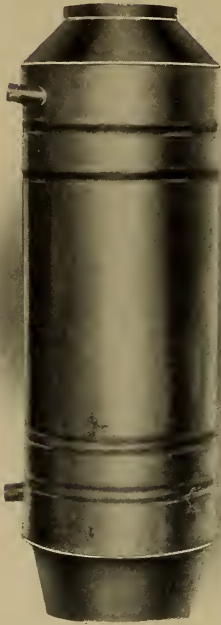

1637-C.

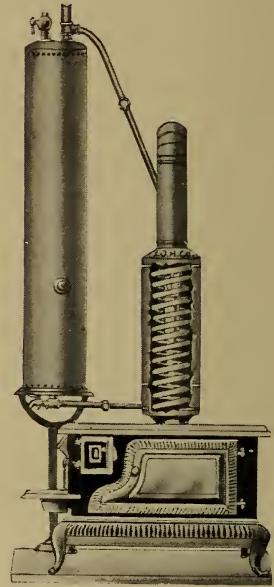

1638-C.

Shows Sectional View of Heater Set on a Range and Connected to an Ordinary Range Boiler.

Cast Iron Top and Base, No. 26 Planished Iron Body, $\frac{3}{4}$ -inch Special Wrought Iron Pipe Coil with inlet and outlet threaded for Standard Iron Pipe. Top Collar takes 6-inch stove pipe. Bottom Collar so made that it can be cut to fit any stove or range collar taking from 6 to 7-inch stove pipe.

Code.....	Pogingen
Height, inches.....	28½
Diameter, inches.....	10½
Each.....	\$10.00
Shipping weight each, lbs.....	44
Shipping measurement each, cubic feet.....	2

One in a crate.

These Heaters are designed for use with stoves and ranges having no water-backs or where water-backs are impracticable, at the same time utilizing the waste heat.

They can be used in connection with heating stoves as well as with cooking stoves and ranges.

When placed on an ordinary stove or range they will give sufficient hot water for kitchen use or for use in lavatories or in bedrooms in ten minutes from the time the fire is started and they will heat an ordinary 30-gallon boiler in 30 minutes. They are great fuel-savers.

In Orders and Specifications give Plate Numbers and Sizes.

“RAPID” INSTANTANEOUS WATER HEATERS.

FOR MANUFACTURED GAS.

Body made of Heavy Copper and Brass, Polished and Nickel-Plated. Burner is made of Fine Gray Iron. Nickel-Plated Shelf and Bracket. Nickel-Plated New Duplex Gas and Water Valves with Unions.

Rapid Self-Cleaning Sprayer, high pressure double stuffing box and one piece water shed.

Code.....	Pogonate
Model.....	C
Height, inches.....	30
Diameter, inches.....	10½
Each, complete.....	\$27.50
Shipping weight, lbs.....	56
Shipping measurement, cubic feet..	3

One in a case.

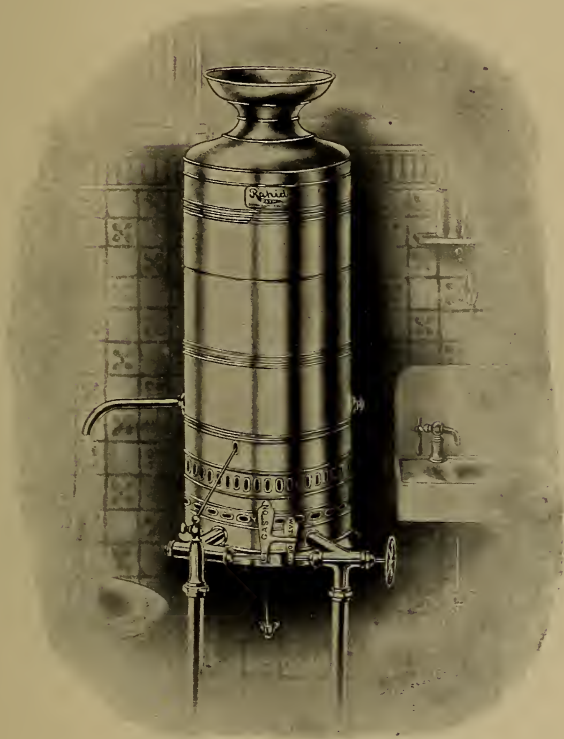

1642-C.

The “Rapid” should be used with city pressure having at least ten pounds pressure to the square inch, and will heat from two to three gallons of water per minute, raising the temperature 60 or 65 degrees.

These heaters will utilize 92 out of a possible 100 heat units.

No Vent Pipe or Flue is required with a ‘Rapid’ Heater. However, to those prejudiced in favor of a vent pipe, the “Rapid” is so constructed as to admit of its use.

Sufficient water for a bath (about twenty gallons) can be heated in five minutes at a cost of one cent with gas at \$1.00 per 1000 feet.

Send for special catalogue of “Rapid” Heaters.

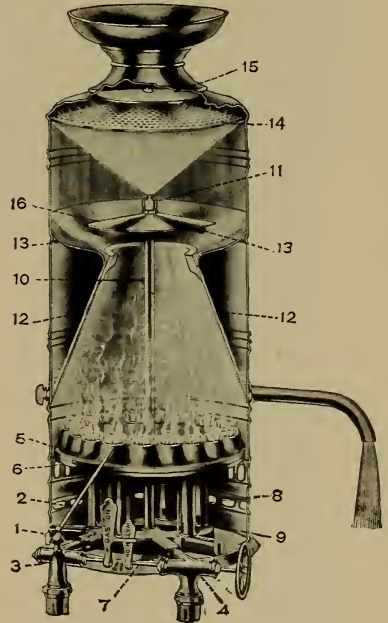

1643-C.

Showing Construction.

Explanatory :

1. Pilot Light Valve.
2. Pilot Light Valve Tube.
3. Gas Valve.
4. Water Valve.
5. Burner Plate (upper).
6. Burner Plate (lower).
7. Gas Chamber.
8. Retort Tubes.
9. Gas Nipples.
10. Stand Pipe.
11. Sprayer.
12. Center Cone.
13. Truncated Cone.
14. Perforated Baffle Plate.
15. Solid Baffle Plate.
16. Water Shed.

In Orders and Specifications give Plate Numbers and Sizes.

CRESCENT INSTANTANEOUS WATER HEATERS.

FOR MANUFACTURED GAS.

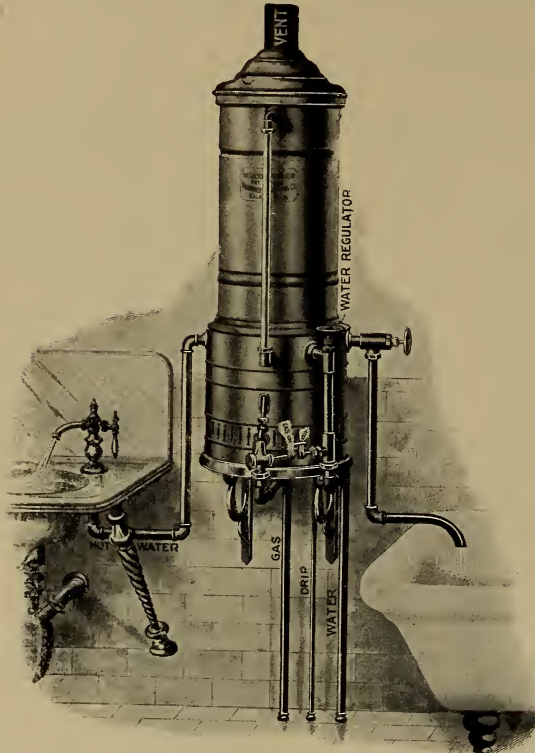

1644-C.

Produces hot water at the rate of 2½ to 3 gallons per minute, raising from 60 degrees inlet temperature to 110 degrees outlet temperature, at a cost of 1¼ cents for gas.

The heater is furnished with Duplex safety valves so that the gas cannot be turned on without the water. Also provided with an extra regulating valve to adjust the water supply and regulate the temperature.

Every Heater must be connected with a vent pipe.

Made entirely of Copper, Nickel-Plated and Highly Polished. Nickel-Plated Shelf and Brackets. Nickel-Plated Duplex Safety Valves and Unions.

Code.....	Pogostome
Number.....	2
Height, inches.....	36
Diameter, inches.....	12
Each.....	\$35.00
Shipping weight, lbs.....	80
Shipping measurement, cu. ft.....	7½

One in a case.

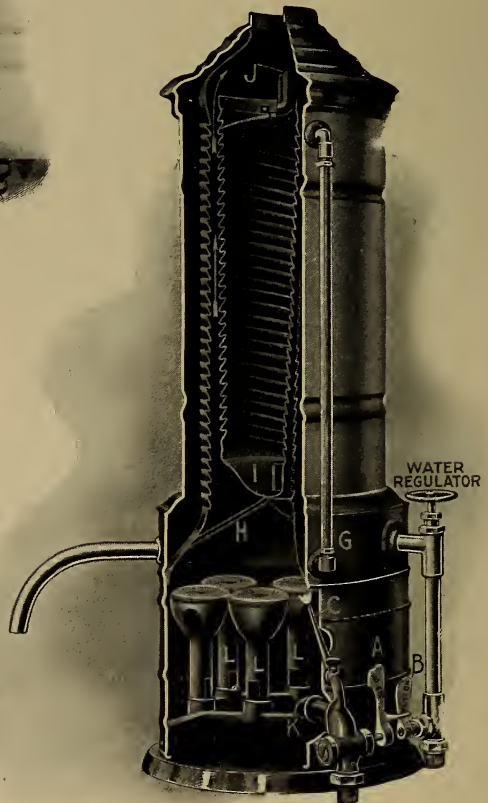

1645-C.

Showing Construction.

Explanatory :

- A. Gas Valve.
- B. Water Valve.
- C and C. Pilot.
- F. Water Regulator.
- G. Water Glass.
- Hand I. Corrugated Copper Tubes.
- J. Cold Water Supply.
- K. Burner Ring.
- L and L. Burner Pipes.

In Orders and Specifications give Plate Numbers and Sizes.

CRESCENT INSTANTANEOUS WATER HEATERS.

FOR MANUFACTURED GAS.

Made entirely of Copper, Nickel-Plated and Highly Polished. Nickel-Plated Shelf and Brackets. Nickel-Plated Duplex Safety Valves and Unions.

Code.....	Poignard	Poignets
Numbers.....	6	† 8
Height, inches.....	30	30
Diameter, inches.....	12	10½
Each	\$25.00	\$20.00
Shipping weight, lbs.	65	45
Shipping measurement, cu. ft.....	6½	4½

One in a case.

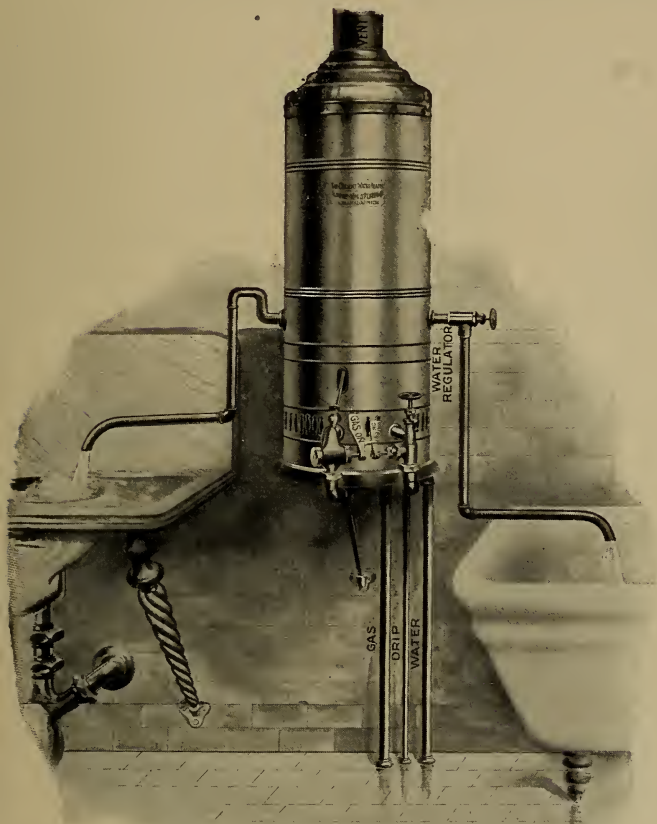

1646-C.

No. 6 Crescent heats 2½ to 3 gallons of water per minute.

No. 8 Crescent heats 2 to 2½ gallons of water per minute.

These Heaters are guaranteed to utilize over 80 per cent of the heat units of the gas.

They will heat water for a bath of 30 gallons in six to ten minutes at about 1¼ cents cost for gas.

Every Heater must be connected with a vent pipe.

† Carried in San Francisco only.

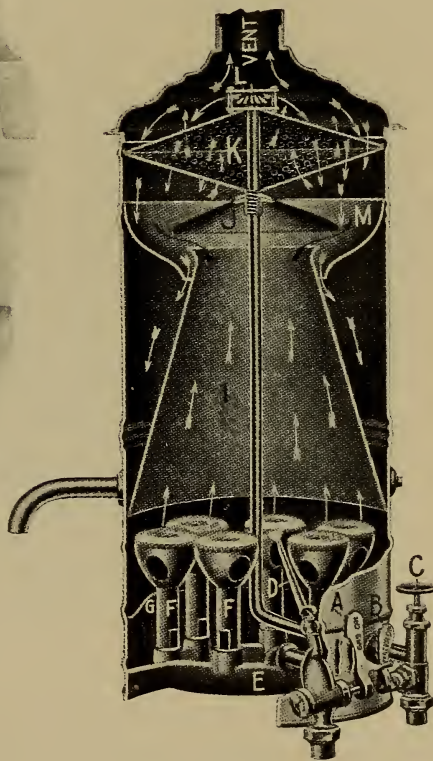

1647-C.

Showing Construction.

Explanatory :

- A. Gas Valve.
- B. Water Valve.
- C. Water Regulator.
- D. Pilot Pipe.
- E. Burner Ring.
- F and F. Burner Pipes.
- G. Drip Ring.
- I. Conical Heating Tube.
- J. Disc to retard and spread passing heat.
- K. Perforated Copper Screens.
- L. Revolving Water Distributor.
- M. Disc to carry falling water to Tube I.

In Orders and Specifications give Plate Numbers and Sizes.

CRESCENT INSTANTANEOUS WATER HEATERS.

FOR GASOLINE.

Made of Copper; Nickel-Plated and Highly Polished; Nickel-Plated Shelf and Brackets.

Code.....	Poincon
Number.....	7
Height, inches.....	30
Diameter, inches.....	12
Each, complete.....	\$29.00
Shipping weight, each, lbs.....	85
Shipping measure, cubic feet.....	9¼

Packed in two cases.



† 1648-C.

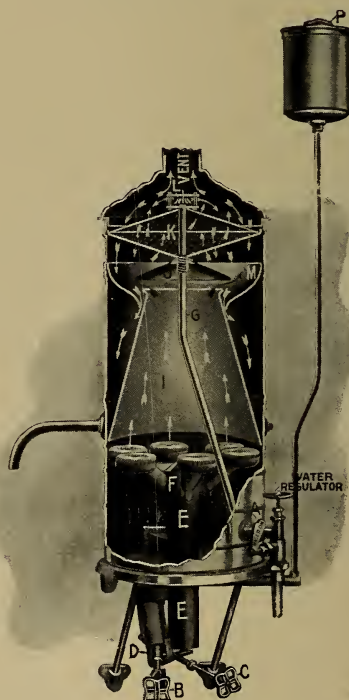

1649-C.

Showing Interior Construction.

Explanatory :

- A. Water Valve.
- B. Generator Handle.
- C. Burner Valve Handle.
- D. Drip Cup.
- E. Burner Arm.
- F. Burner.
- G. Water Supply Pipe.
- H. Sight Hole.
- I. Conical Heating Tube.
- J. Disk to retard and spread passing heat.
- K. Perforated Copper Screens.
- L. Revolving Water Distributor.
- M. Disk to carry falling water to Tube I.
- P. Valve to close gasoline supply.

For use in city, country and suburban homes, where gas connections cannot be had.

Will heat two gallons of water per minute from 50 degrees inlet to 100 degrees outlet temperature, and enough for a bath at an average cost of two cents for gasoline.

Every Heater must be connected with a vent pipe.

† Carried in San Francisco only.

In Orders and Specifications give Plate Numbers and Sizes.

“LAWSON” GASOLINE WATER HEATERS.

FOR QUICKLY AND ECONOMICALLY HEATING WATER BY GASOLINE FOR HOUSEHOLD PURPOSES.

To be used in connection with an ordinary Range Boiler.



1655-C.

Code.....	Poisoned
Height, inches.....	26
Diameter, inches.....	6
Each, complete.....	\$20.00
Shipping weight, lbs.....
Shipping measurement, cubic feet.....

One in a crate.

This heater is similar in construction to the well-known Lawson Gas Heater, shown on page 439, and consists of a seamless copper coil, surrounded by an asbestos-lined Russia Iron Jacket. The burner is especially designed to meet the requirements of gasoline combustion.

For localities where gas is not available, this heater is unexcelled.

It is compact, efficient, economical and low in price. It can be readily connected, and always gives perfect satisfaction.

These heaters must be connected with a vent pipe.

In Orders and Specifications give Plate Numbers and Sizes.

MENLO TANK HEATERS.

FOR COAL.



1620-C.



1621-C.

Showing Construction of Dome.

Code.....	Poetaster	Poetavate	Poetavit
Numbers.....	1	1½	2
Tank Capacity, gals...	120	180	260
Each.....	\$30.00	40.00	50.00
Shipping Weight, lbs.	361	451

Dimensions:

Numbers	1	†1½	†2
Width at floor, inches.....	19½	22	24½
Length at floor, inches.....	19½	22	24½
Total height, inches.....	32½	34	35½
Height of base, inches.....	8½	8½	8½
Height of dome, inches.....	24	25½	27
Outside diameter of dome, in..	15	17½	20
Diameter of grate, inches.....	10	12	14
Depth of fire, inches.....	11½	11½	12½
Diameter of smoke pipe, in....	5	5	6
Distance from floor to center of smoke pipe, inches.....	25¾	26½	30¼

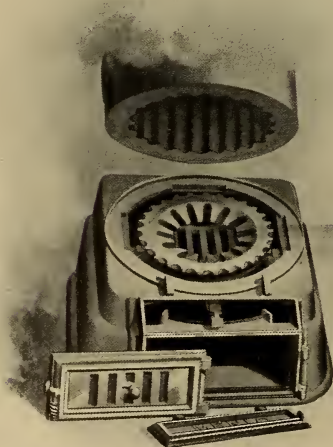

1622-C.

Showing Base and Grate Construction.

† Carried in San Francisco only.

In Orders and Specifications give Plate Numbers and Sizes

COTTAGE WATER BOILERS.

FOR WOOD OR COAL.



1625-C.

Cut shows Small Fire Door for Coal.



1626-C.

Cut shows Large Fire Door for Wood.

Nos.	Code for Coal.	* Price for Coal.	Size of Grate, Inches.	Square Feet Radiation Supplied.	Tank Capacity, Gallons.	Shipping Weight, Lbs.	Code for Wood.	* Price for Wood.	Nos.
00	Poissard	\$52.00	12x12	200	275	727	Pokgist.....	\$ 54.00	00
0	Poisseux	63.00	12x16	275	375	780	Pokhout.....	65.00	0
1	Poissillon ...	73.00	16x16	350	450	980	Pokstof.....	79.00	1
2	Poissions.....	92.00	16x20	475	625	1111	Polacchina...	100.00	2
3	Pokachtig...	114.00	16x24	575	750	1291	Polacenio.....	123.00	3
4	Pokal.....	146.00	20x24	775	1025	1639	Polackei.....	156.00	4
5	Pokdalig.....	180.00	20x30	975	1300	2020	Polacra.....	193.00	5
6	Pokeweed...	218.00	20x36	1225	1600	2200	Polainae.....	233.00	6

*The above prices are for the Boiler complete with Fire Tools, which include Flue Brush with Handle and Shovel.

Dimensions.

Nos.	Regular Tapping.		Height, Inches.	Width, Inches.	Length, Inches.	Diameter of Smoke Pipe, in Inches.	Distance from Floor to top of Smoke Bonnet, in Inches.
	Supply, Inches.	Return, Inches.					
00	2-2	1-2	47	23	27	5 ³ / ₁₆	27 ¹ / ₄
0	1-2 2-2 ¹ / ₂	1-2 ¹ / ₂	47	23	31	5 ³ / ₁₆	27 ¹ / ₄
1	1-2 2-2 ¹ / ₂	1-2 ¹ / ₂	48	31	31	7	31
2	2-2 ¹ / ₂	2-2 ¹ / ₂	48	31	35	7	31
3	2-2 ¹ / ₂	2-2 ¹ / ₂	48	31	39	7	31
4	2-2 ¹ / ₂	2-2 ¹ / ₂	52	35	39	9	35 ³ / ₄
5	2-3	2-3	52	35	45	9	35 ³ / ₄
6	{ 2-3 } { 2-2 ¹ / ₂ }	2-3	52	35	51	9	35 ³ / ₄

COTTAGE WOOD BURNING BOILERS.

These Boilers are the same as the regular Water and Steam Boilers, with the exception that they have large **Fire Doors** and **Grate Covers**. Wood Burning Boilers can be used for burning coal, as the regular grate is furnished.

Size of Large Fire Doors:

Nos. 00 and 0....5¹/₂x9 inches. Nos. 1, 2 and 3....10³/₄x11¹/₄ inches. Nos. 4, 5 and 6....12x14 inches.

For Boiler Ratings see page 450.

In Orders and Specifications give Plate Numbers and Sizes.

COTTAGE STEAM BOILERS.

FOR WOOD OR COAL.

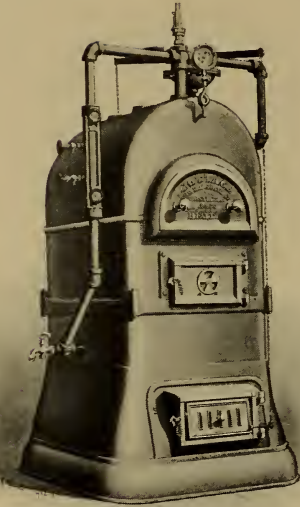

1629-C.

Cut shows Cottage Steam Boiler for Coal.

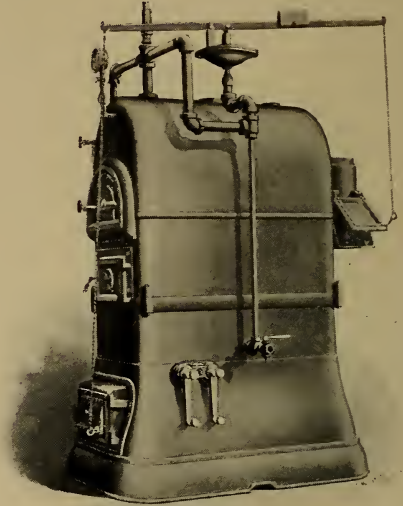

1630-C.

Cut shows Side View of Cottage Steam Boiler.

Nos.	Code for Coal.	*Price for Coal.	Size of Grate, Inches.	Square Feet Radiation Supplied.	Shipping Weight, Lbs.	Code for Wood.	*Price for Wood.	Nos.
00	Polanisia	\$ 72.00	12 x 12	135	790	Polaristic	\$ 75.00	00
0	Polaques	83.00	12 x 16	175	847	Polarizada	86.00	0
1	Polarbaer	94.00	16 x 16	225	1164	Polarize	100.00	1
2	Polarchy	114.00	16 x 20	275	1305	Polarizing	121.00	2
3	Polarfuchs	136.00	16 x 24	350	1438	Polarkreis	143.00	3
4	Polaridade	165.00	20 x 24	475	1863	Polarlicht	178.00	4
5	Polarily	200.00	20 x 30	600	2252	Polarmeer	214.00	5
6	Polarisant	238.00	20 x 36	750	2614	Polarstern	253.00	6

* The above prices are for the boiler complete, with trimmings and connections as shown, together with fire tools, which include flue brush with handle and shovel.

DIMENSIONS.

Nos.	**Regular Tapping.		Height in Inches.	Width in Inches.	Length in Inches.	Height Water Line in Inches.	Diameter of Smoke Pipe in Inches.	Distance from Floor to Top of Smoke Bonnet in Inches.
	Supply, Inches.	Return, Inches.						
00	1-2	1-2	47	23	27	41½	5 13/16	27¼
0	1-2½	1-2½	47	23	31	41½	5 13/16	27¼
1	1-1¼-1-2	1-1½	53	31	31	45½	7	31
2	1-1¼-1-2½	1-2	53	31	35	45½	7	31
3	1-2-1-2½	1-2	53	31	39	45½	7	31
4	1-2-1-3	1-2½	68	35	39	50½	9	32¾
5	1-2-1-3	1-2½	68	35	45	50½	9	32¾
6	1-2-1-3	1-2½	68	35	51	50½	9	32¾

** In addition to the above tappings on top of Steam Boilers, there will be 1-1¼-inch hole in Nos 00, 0, 1, 2, 3 and 4 Boilers, 1-1½-inch in No. 5 Boiler, and 1-2-inch in No. 6 Boiler. These tappings are to be used for steam trimmings.

Send for Special Catalogue on Boilers. For Boiler Ratings see page 450.

In Orders and Specifications give Plate Numbers and Sizes.

COTTAGE WATER BOILERS.



1631-C.

Showing Parts and Method of Shaking
Numbers 00, 0, 1, 2 and 3.



1632-C.

Method of Shaking
Numbers 4, 5 and 6.

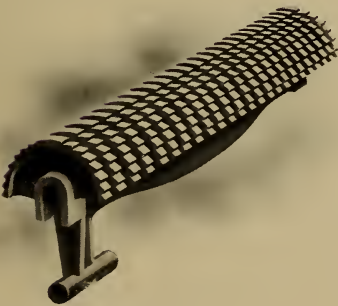

1633-C.

Section of Grate.

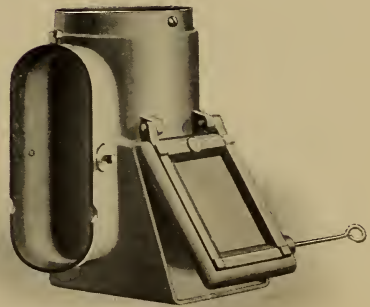

1634-C.

Smoke Bonnet.
Shipped with all Cottage Boilers.

In Orders and Specifications give Plate Numbers and Sizes.

MERCER BOILERS.

FOR WATER OR STEAM WARMING. HARD OR SOFT COAL.

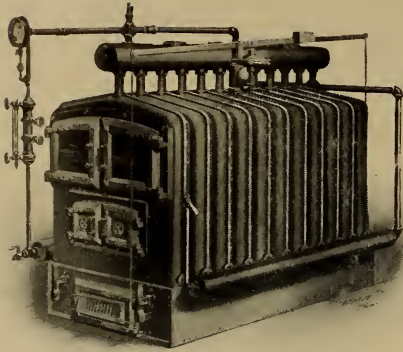

1640-C.
Mercer Steam Boiler.

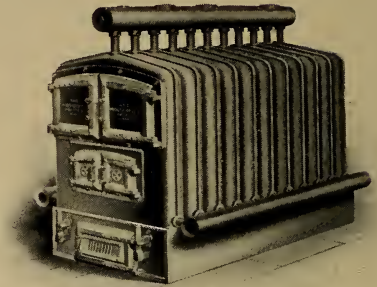

1641-C.
Mercer Water Boiler.

NO. 1 MERCER BOILER.

Code for Steam	Polarstrom	Polaruhr	Polary	Polarzone	Polastre	Polatouche	Polatucha	Polbildung
Code for Water	Polcaba	Polcabamos	Polcamos	Polcando	Polcaron	Poldergast	Poldway	Poleadas
Numbers.....	518	618	718	818	918	1018	1118	1218
Number of sections..	5	6	7	8	9	10	11	12
*Price for Steam	\$180.00	213.00	245.00	278.00	310.00	343.00	375.00	408.00
*Price for Water.....	172.00	205.00	237.00	270.00	302.00	335.00	367.00	400.00
Shipping weight, lbs	2101	2433	2772	3104	3441	3787	4148	4481

*The above prices are for Boilers complete with trimmings, together with fire tools, which include flue brush with handle and shovel. Pipe and fittings for connecting trimmings on steam Boilers not included.

Dimensions.

Numbers.	Number of Sections.	**Square Feet Steam Radiation Supplied.	**Square Feet Water Radiation Supplied.	Size of Grate, Inches.	Square Feet of Grate Surface.	Square Feet of Fire Surface.	Total Length, Inches.
518	5	425	700	18x18	2¼	60	39
618	6	550	900	18x24	3	72	45
718	7	675	1100	18x30	3¾	84	51
818	8	800	1325	18x36	4½	96	57
918	9	950	1550	18x42	5¼	108	63
1018	10	1100	1800	18x48	6	120	69
1118	11	1225	2025	18x54	6¾	132	75
1218	12	1350	2250	18x60	7½	144	81

Total height, 69 inches. Total width, 45 inches. Height of water line, 51 inches. Diameter of Smoke Pipe, 9 inches. Distance from Floor to center of Smoke Pipe, 35¾ inches.

Mercer Boilers can be furnished with Grates 6, 12 and 18 inches shorter than Grate measurements given, at above prices. Grates can be furnished 6 inches longer than above at additional prices.

REGULAR TAPPINGS—SUPPLY DRUMS.

Outside Diameter, 6 inches. Each end tapped for 2½-inch pipe.

REGULAR TAPPINGS—RETURN DRUMS.

Outside Diameter, 4 inches.

No. of Holes for Lock-Nut Nipples.	Size and Number of Holes on Top.					
	1-In.	1¼-In.	1½-In.	2-In.	2½-In.	3-In.
5	1	2	...	1
6	1	2	...	1
7	...	1	...	2	...	1
8	...	1	...	2	...	1
9	...	1	2	1
10	1	...	2	1
11	1	...	2	1
12	1	...	2	1

Tapped for 1½-inch Lock-Nut Nipples.

Each end tapped for 2½-inch pipe.

All Return Drums have one 2-inch hole on top near end, and one 2-inch hole on under side near opposite end.

Parties wishing Drums tapped differently from above, specify on order.

** For Boiler Ratings see page 450.

In Orders and Specifications give Plate Numbers and Sizes.

MERCER BOILERS.

FOR WATER OR STEAM WARMING. HARD OR SOFT COAL.

NO. 2 MERCER BOILER.

Code for Steam	Polearum	Poledrino	Poleggio	Polemannie	Polemarch
Code for Water.....	Polemj	Polenor	Polentarum	Polergal	Polewards
Numbers.....	727	827	927	1027	1127
Number of sections.....	7	8	9	10	11
*Price for Steam.....	\$344.00	396.00	448.00	500.00	552.00
*Price for Water.....	334.00	386.00	438.00	490.00	542.00
Shipping weight, lbs.....	3994	4478	4941	5420	5920
Code for Steam.....	Polemarque	Polemical	Polemicist	Polemonium	Polemusa
Code for Water.....	Polewig	Polhacra	Polhinha	Polhodie	Poliacanto
Numbers.....	1227	1327	1427	1527	1627
Number of sections.....	12	13	14	15	16
*Price for Steam.....	\$604.00	656.00	708.00	760.00	812.00
*Price for Water.....	594.00	646.00	698.00	750.00	802.00
Shipping weight, lbs.....	6370	6883	7360

*The above prices are for Boilers complete with trimmings, together with fire tools, which include flue brush with handle and shovel. Pipe and fittings for connecting trimmings on Steam Boilers not included.

Dimensions.

Numbers.	Number of Sections.	**Square Feet Steam Radiation Supplied.	**Square Feet. Water Radiation Supplied.	Size of Grate, Inches.	Square Feet of Grate Surface.	Square Feet of Fire Surface.	Total Length, Inches.
727	7	1100	1825	27 x 30	5½	126	52
827	8	1275	2100	27 x 36	6¾	144	58
927	9	1475	2450	27 x 42	7½	162	64
1027	10	1675	2775	27 x 48	9	180	70
1127	11	1950	3225	27 x 54	10½	198	76
1227	12	2250	3700	27 x 60	11¼	216	82
1327	13	2500	4125	27 x 66	12¾	234	88
1427	14	2750	4550	27 x 72	13½	252	94
1527	15	3000	4950	27 x 78	14¾	270	100
1627	16	3250	5375	27 x 84	15¾	288	106

Total height, 80 inches. Total width, 60 inches. Height of water line, 57 inches. Diameter of Smoke Pipe, 12 inches. Distance from floor to center of Smoke Pipe, 38¼ inches.

Mercer Boilers can be furnished with Grates 6, 12 and 18 inches shorter than Grate measurements given, at above prices. Grates can be furnished 6 inches longer than above at additional prices.

REGULAR TAPPINGS—SUPPLY DRUMS.

Outside diameter, 8 inches. Each end tapped for ½-inch pipe.

No. of Holes for Lock-Nut Nipples.	Size and Number of Holes on Top.			
	1½-Inch.	2-Inch.	3-Inch.	4-Inch.
7	1	2	1
8	1	2	1
9	1	2	1
10	1	3
11	1	3
12	1	3
13	1	3
14	1	3
15	1	3
16	1	3

REGULAR TAPPINGS—RETURN DRUMS.

Outside diameter, 6 inches. Tapped for ½-inch Lock-Nut Nipples. Front end tapped for ½-inch pipe. Rear end tapped for 4-inch pipe.

All Return Drums have one 2-inch hole on top near end and one 2-inch hole on under side near opposite end.

Parties wishing Drums tapped differently from above, specify on order.

**For Boiler Ratings see page 450. Send for special catalogue of Boilers.

In Orders and Specifications give Plate Numbers and Sizes.

MERCER BOILERS.

FOR WATER OR STEAM WARMING. HARD OR SOFT COAL.

No. 3 MERCER BOILER.

Code for Steam.....	Poliandria	Poliandro	Poliantere	Polianthes	Poliarcas
Code for Water.....	Police	Policeman	Policheto	Polidor	Poliebat
Numbers.....	836	936	1036	1136	1236
Number of sections.....	8	9	10	11	12
*Price for Steam.....	\$534.00	597.00	660.00	723.00	786.00
*Price for Water.....	522.00	585.00	648.00	711.00	774.00
Shipping weight, lbs.....	6166	6816	7482	8129	8803
Code for Steam.....		Poliarchia	Poliarque	Policant	Policarpo
Code for Water.....		Poliedar	Poliemia	Poliendos	Polierbank
Numbers.....		1336	1436	1536	1636
Number of sections.....		13	14	15	16
*Price for Steam.....		\$849.00	912.00	975.00	1038.00
*Price for Water.....		837.00	900.00	963.00	1026.00
Shipping weight, lbs.....		9471	10222	10837	11581

*The above prices are for Boilers complete with trimmings, together with fire tools, including flue brush with handle and shovel. Pipe and fittings for connecting trimmings on Steam Boilers not included.

Dimensions.

Numbers.	Number of Sections.	**Square Feet Steam Radiation Supplied.	**Square Feet Water Radiation Supplied.	Size of Grate, Inches.	Square Feet of Grate Surface.	Square Feet of Fire Surface.	Total Length, Inches.
836	8	1825	3000	36 x 36	9	195	58
936	9	2175	3575	36 x 42	10 1/2	225	64
1036	10	2500	4125	36 x 48	12	255	70
1136	11	2850	4700	36 x 54	13 1/2	285	76
1236	12	3200	5275	36 x 60	15	315	82
1336	13	3500	5775	36 x 66	16 1/2	345	88
1436	14	3900	6450	36 x 72	18	375	94
1536	15	4300	7100	36 x 78	19 1/2	405	100
1636	16	4700	7775	36 x 84	21	435	106

Total height, 83 inches. Total width, 70 inches. Height of water line, 59 inches. Smoke Pipe (oval), 15 1/4 x 12 3/8 inches, equals 14-inch round pipe.

Distance from floor to center of Smoke Pipe, 41 1/8 inches.

REGULAR TAPPINGS—SUPPLY DRUMS.

Outside diameter, 10 inches. Each end tapped for 2 1/2-inch pipe.

No. of Holes for Lock-Nut Nipples.	Size and Number of Holes on Top.			
	2-Inch.	4-Inch.	5-Inch.	6-Inch.
8	1	3
9	1	3
10	1	2	1
11	1	2	1
12	1	2	1
13	1	2	1
14	1	2	1
15	1	3
16	1	3

REGULAR TAPPINGS—RETURN DRUMS.

Outside diameter, 8 inches. Tapped for 2-inch Lock-Nut Nipples. Tapped 2 1/2-inch front end.

8 Hole Drum tapped 4-inch rear end.

9, 10, 11 Hole Drum tapped 5-inch rear end.

12, 13, 14, 15, 16 Hole Drum tapped 6-inch rear end.

All Return Drums have one 2-inch hole on top near end and one 2-inch hole on under side near opposite end.

Parties wishing Drums tapped differently from above, specify on order.

****BOILER RATINGS.**

Steam Boiler Ratings are based on maintaining two pounds pressure at the boiler.

Water Boiler Ratings are based on the water being maintained at a temperature of 180 degrees at the boiler.

Sufficient surface must be proportioned to easily raise and maintain a temperature of 70 degrees. These Ratings are for Direct Radiation.

In estimating the size of the Boiler required, all piping (Mains and Risers, Flows and Returns) should be figured as radiating surface in addition to the Cast Iron Direct Radiators. Usual allowances must be made for the use of Pipe Coils, Direct-Indirect and Indirect Radiation.

In Orders and Specifications give Plate Numbers and Sizes.

MERCER BOILERS.

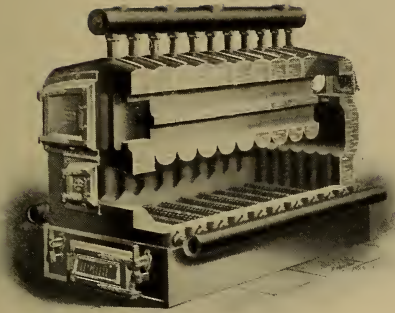

1642-C.

Sectional View. Grate Full Size.

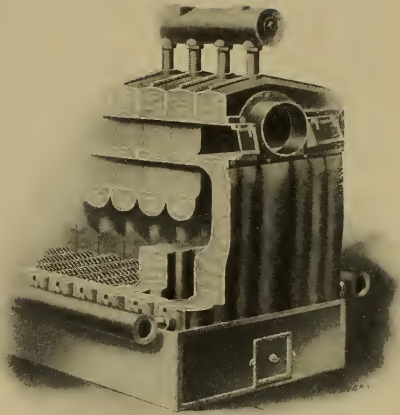

1643-C.

Fire Back Section in Position. Grate Reduced Twelve Inches.

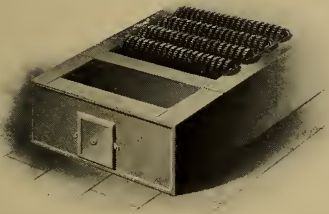

1644-C.

Ash Pit Walls. Grate Reduced Twelve Inches.

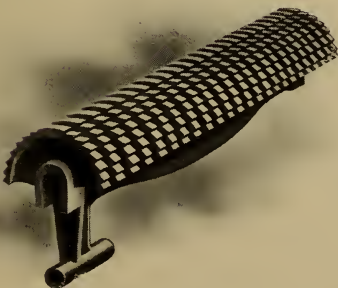

1645-C.

Section of Grate.

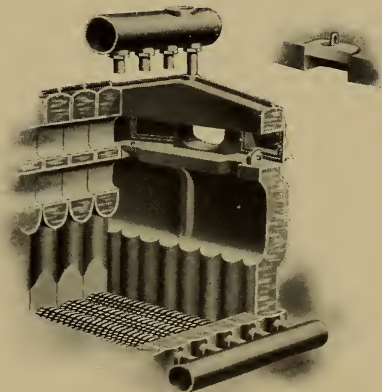

1646-C.

Extreme Back Section in position, showing Cleaning Plugs. Plugs removed only when Flues are cleaned.

Write for Special Catalogue of Water and Steam Boilers.

In Orders and Specifications give Plate Numbers and Sizes.

ROYAL UNION RADIATORS.

STEAM OR WATER.

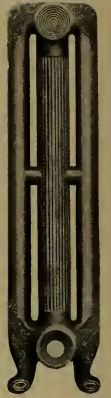

Dimensions of Section:

Total width at Floor, 8 5/8 inches.
 Width of Section, 8 5/8 "
 Length of Section, 3 "

1650-C.

1651-C.

RADIATING SURFACE (Square Feet).

No. of Sections.	*Total Length, Inches.	Code.	44 Inches High.	Code.	38 Inches High.	Code.	30 Inches High.	Code.	24 Inches High.	Code.	18 Inches High.
2	6	Polierfilz.....	12	Polion	10	Polit	8	Pollaccone ...	6	Pollinxit.....	4
3	9	Polierroth....	18	Polionem	15	Politea	12	Pollak	9	Polliono	6
4	12	Poliersand....	24	Polionibus ...	20	Politeismo ...	16	Pollage.....	12	Polliwigs	8
5	15	Polieum	30	Polionis	25	Politesse... ..	20	Pollarded	15	Pollocks	10
6	18	Polifagia.....	36	Poliopsia.....	30	Politezza.....	24	Pollastra.....	18	Pollonando ...	12
7	21	Polifilia.....	42	Poliorum.....	35	Politica.....	28	Pollazon	21	Pollonasse... ..	14
8	24	Polifolias....	48	Poliosome	40	Politicien... ..	32	Polladay.....	24	Pollucao	16
9	27	Poliforo	54	Poliottro.....	45	Politicy	36	Pollebamus..	27	Pollucebis... ..	18
10	30	Poligalina....	60	Polipario.....	50	Politicona. ...	40	Pollebro	30	Pollucenda... ..	20
11	33	Poligamia....	66	Polipastos ...	55	Politionis... ..	44	Pollegada....	33	Polluceret... ..	22
12	36	Poligar	72	Polipatalo ...	60	Politiorum ...	48	Pollenger	36	Pollucta.....	24
13	39	Poliglotos....	78	Poliponia.....	65	Politipia ...	52	Pollenies	39	Polluebare... ..	26
14	42	Poligonato ...	84	Polipite	70	Politique ..	56	Pollepell	42	Polluerem... ..	28
15	45	Poligono	90	Polipo	75	Politize	60	Pollezno	45	Polluximus... ..	30
16	48	Poligrafo	96	Polipodio	80	Politos.....	64	Pollicare.....	48	Pollyxene.....	32
17	51	Poligrammo ..	102	Polipogono ...	85	Politricio ...	68	Pollicates....	51	Polmoewe ...	34
18	54	Polilepa.....	108	Polipremno ...	90	Politrofia... ..	72	Pollicebar ...	54	Polmonia	36
19	57	Polilha.....	114	Poliprione ...	95	Polittongo ...	76	Pollicecor ...	57	Polnacht	38
20	60	Polilinfia....	120	Polisander... ..	100	Polituram ...	80	Pollichies ...	60	Polnisch	40
21	63	Polilogia.....	126	Polisarcia....	105	Polirurica... ..	84	Pollicipes ...	63	Polochion ...	42
22	66	Polimes.....	132	Poliscopio... ..	110	Poliuoto	88	Pollicitore....	66	Polochres ...	44
23	69	Polimento... ..	138	Polishable ...	115	Polivalvo... ..	92	Pollies	69	Poloneses... ..	46
24	72	Poliminum ...	144	Polishment... ..	120	Polizeau ...	96	Pollinar.....	72	Polorum	48
25	75	Polimisso	150	Polisilabo....	125	Poliziano ...	100	Pollinatos....	75	Polpa.....	50
26	78	Polimorfa....	156	Polispasto... ..	130	Polizonite ...	104	Pollinctor ...	78	Polpacao ...	52
27	81	Polinnia.....	162	Polissage	135	Polizzina ...	108	Pollineux	81	Polpetta	54
28	84	Polinomio....	168	Polissais.....	140	Polkeurs.....	112	Pollinges....	84	Polpodes....	56
29	87	Poliodonte... ..	174	Polisseurs ...	145	Polkiez	116	Pollinibus ...	87	Polpudo	58
30	90	Polionmato ...	180	Polostico	150	Polkons....	120	Pollinique ...	90	Polque.....	60
Approximate weight per square foot, lbs.			7	7	7	7	7
List per square foot.....			\$0.4142465058

Distance from Floor to Center Regular Tapping (all heights and sizes) 4 3/8 inches.

Water Radiators tapped 2-inch Top and Bottom one end, 2-inch opposite end. Steam Radiators tapped 2-inch Bottom, each end. The Return End Section tapped for Air Valves, 1/2-inch, either Steam or Water.

* Add 1 1/2 inches to total length for Radiator Bushings.

See pages 458 and 459 for Regular Tappings.

In Orders and Specifications give Plate Numbers and Number of Sections.

IMPERIAL UNION RADIATORS.

STEAM OR WATER.

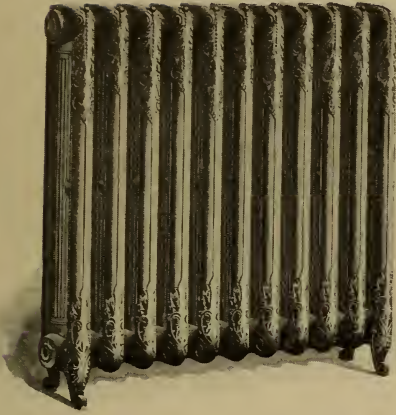

1654-C.



1655-C.

Dimensions of Section:

Total Width at Floor, 9 inches.
 Width of Section, 9 "
 Length per Section, 3 1/4 "

RADIATING SURFACE (Square Feet).

No. of Sections.	*Total Length, Inches.	Code.	45 Inches High.	Code.	37 Inches High.	Code.	31 Inches High.	Code.	25 Inches High.	Code.	19 Inches High.
2	6 1/2	Polschuss.....	16	Polviglio.....	13	Polydesmes..	11	Polylogue.....	9	Polyptote....	7
3	9 3/4	Polshamer ...	24	Polvilhar.....	19 1/2	Polydiclie....	16 1/2	Polylogy.....	13 1/2	Polypum.....	10 1/2
4	13	Polsmeter.....	32	Polviscolo....	26	Polydipsie ...	22	Polymath.....	18	Polyscias....	14
5	16 1/4	Polsslag.....	40	Polvora.....	32 1/2	Polyedre.....	27 1/2	Polymedon....	22 1/2	Polyscope....	17 1/2
6	19 1/2	Polstok.....	48	Polvoreado....	39	Polyedrous..	33	Polymestor...	27	Polyselmis..	21
7	22 3/4	Polster.....	56	Polvorento....	45 1/2	Polyergie. ...	38 1/2	Polymetre....	31 1/2	Polysemi....	24 1/2
8	26	Poltern.....	64	Polvorinho...	52	Polyfoil.....	44	Polymiaire...	36	Polysemos..	28
9	29 1/4	Polterton....	72	Polvorista...	58 1/2	Polygalas....	49 1/2	Polymitos....	40 1/2	Polysome....	31 1/2
10	32 1/2	Poltrao.....	80	Polvoriza....	65	Polygalon ...	55	Polymnite....	45	Polyspat....	35
11	35 3/4	Poltrendo ...	88	Polvorosas...	71 1/2	Polygamiam...	60 1/2	Polynemus...	49 1/2	Polyspile...	38 1/2
12	39	Poltrimmo...	96	Polyachyre ...	78	Polygarchy...	66	Polynome....	54	Polystemon...	42
13	42 1/4	Poltrisco....	104	Polyadenes...	84 1/2	Polygenist...	71 1/2	Polynus.....	58 1/2	Polystyle...	45 1/2
14	45 1/2	Poltrivamo...	112	Polyaenus....	91	Polygiton....	77	Polypage.....	63	Polyteles....	49
15	48 3/4	Poltrona....	120	Polyandres...	97 1/2	Polyglotta...	82 1/2	Polypary.....	67 1/2	Polytimus...	52 1/2
16	52	Poltroon....	128	Polyanthea...	104	Polygnathe...	88	Polypedies...	72	Polytmes....	56
17	55 1/4	Polubris.....	136	Polyaratus...	110 1/2	Polygnoti....	93 1/2	Polypeux....	76 1/2	Polytone....	59 1/2
18	58 1/2	Poluli.....	144	Polyarchie...	117	Polygomphe...	99	Polypagos...	81	Polytrope...	63
19	61 3/4	Polulos.....	152	Polyargite...	123 1/2	Polygonal....	104 1/2	Polypheмо...	85 1/2	Polyxena....	66 1/2
20	65	Polulum....	160	Polyatomic...	130	Polygonium...	110	Polypnides...	90	Polyxo.....	70
21	68 1/4	Polusacco...	168	Polybaphie...	136 1/2	Polygonope...	115 1/2	Polypfony...	94 1/2	Pomacanto...	73 1/2
22	71 1/2	Polusca.....	176	Polybasic....	143	Polygram....	121	Polypnrade..	99	Pomace.....	77
23	74 3/4	Polvareda...	184	Polybetes....	149 1/2	Polygynia ...	126 1/2	Polypier.....	103 1/2	Pomaceae...	80 1/2
24	78	Polverando...	192	Polybidas...	156	Polyhalite...	132	Polypifera ...	108	Pomachile...	84
25	81 1/4	Polverassi...	200	Polybis.....	162 1/2	Polyhistor...	137 1/2	Polypifgas...	112 1/2	Pomacies ...	87 1/2
26	84 1/2	Polverato...	208	Polyboles...	169	Polyides....	143	Polypodium...	117	Pomadasy...	91
27	87 3/4	Polverava...	216	Polybore....	175 1/2	Polykrates...	148 1/2	Polyporum...	121 1/2	Pomadiger...	94 1/2
28	91	Polverini...	224	Polybotum...	182	Polylaus....	154	Polyposo....	126	Pomagem...	98
29	94 1/4	Polvificar...	232	Polydamna...	188 1/2	Polylepis....	159 1/2	Polypous....	130 1/2	Pomarins...	101 1/2
30	97 1/2	Polvifique...	240	Polydecetes...	195	Polylobe....	165	Polypnion ...	135	Pomastome...	105
Approximate weight per square foot, lbs.			6 1/2	6 1/2	6 1/2	6 1/2	6 1/2
List per square foot....			\$0.4142465057

Distance from Floor to Center Regular Tapping (all heights and sizes) 4 1/2 inches.

Water Radiators tapped 2-inch Top and Bottom one end, 2-inch opposite end. Steam Radiators tapped 2-inch Bottom, each end. The Return End Section tapped for Air Valves, 1/8-inch Steam or Water.

* Add 1 1/2 inches to total length for Radiator Bushings.

See pages 458 and 459 for Regular Tappings.

In Orders and Specifications give Plate Numbers and Number of Sections.

PRINCESS UNION RADIATORS.

STEAM OR WATER.

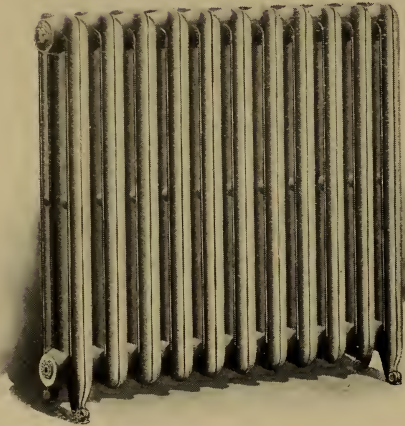

1656-C.



1657-C.

Dimensions of Section :

Total width at floor.....9 inches.

Width of section.....9 “

Length of section.....3¼ “

These Radiators are the same size and price as Imperial Union Radiators. See page 453.

DIADEM RADIATORS.

STEAM OR WATER.



1658-C.

Dimensions of Section :

Total width at floor.....5¼ inches.

Width of section..... 5¼ “

Length of section.....3 “

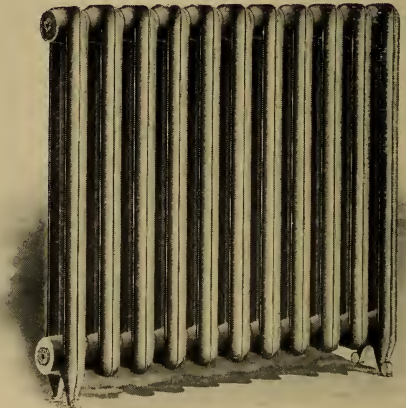

1659-C.

These Radiators are the same size and prize as Coronet Radiators. See page 455.

See pages 458 and 459 for Regular Tappings.

In Orders and Specifications give Plate Numbers and Number of Sections.

CORONET RADIATORS.

STEAM OR WATER.



1660-C.



1661-C.

Dimensions of Section :

Total width at Floor, 5¼ inches.
 Width of Section, 5¼ “
 Length per Section, 3 “

RADIATING SURFACE (Square Feet).

No. of Sections.	*Total Length, Inches.	Code.	45 Inches High.	Code.	47 Inches High.	Code.	49 Inches High.	Code.	25 Inches High.	Code.	19 Inches High.
2	6	Pomations....	9	Pompabile....	7	Pompion	6	Ponderamos	5	Pongut.....	4
3	9	Pomatomo...	13½	Pompabunt..	10½	Pompire	9	Ponderance..	7½	Poniamo.....	6
4	12	Pomatumed..	18	Pompais.....	14	Pompiscus....	12	Ponderaron..	10	Poniard	8
5	15	Pomax.....	22½	Pompamun ..	17½	Pomplamo....	15	Ponderato...	12½	Ponibility...	10
6	18	Pombinha ...	27	Pomparetis ..	21	Pompmaker..	18	Ponderava...	15	Ponidore ...	12
7	21	Pomella	31½	Pomparoso ..	24½	Pompoleon... 21	Ponderavel ..	17½	Pontentada ..	14	
8	24	Pomellato ...	36	Pompasses... 28	Pomponios... 24	Ponderer..... 20	Ponnaca..... 16				
9	27	Pometiam ...	40½	Pompaticos.. 31½	Pomponium.. 27	Pondereux.... 22½	Ponskom 18				
10	30	Pometinis ...	45	Pompavisti .. 35	Pompsons 30	Ponderibus... 25	Ponslepel.... 20				
11	33	Pometis ...	49½	Pompboor ... 38½	Pomposas.... 33	Ponderoso.... 27½	Ponslied..... 22				
12	36	Pomfolige ...	54	Pompbouten 42	Pomposita.... 36	Pondeuses ... 30	Ponsschaal.. 24				
13	39	Pomifero	58½	Pompdaal ... 45½	Pomposo..... 39	Pongeld..... 32½	Pontaggio ... 26				
14	42	Pomiforme ...	63	Pompeabas .. 49	Pomput..... 42	Ponduis..... 35	Pontage..... 28				
15	45	Pomilliones ..	67½	Pompeggia .. 52½	Pompstag.... 45	Pondicula.... 37½	Pontalets.... 30				
16	48	Pommadiez... 72	Pompejani... 56	Pompstang .. 48	Pondpapier.. 40	Pontarios.... 32					
17	51	Pommaille... 76½	Pompejanos. 59½	Pompsteel ... 51	Pondspeer ... 42½	Ponteado.... 34					
18	54	Pommeau.... 81	Pomper..... 63	Pompstok.... 54	Ponebamus .. 45	Pontearan ... 36					
19	57	Pommelion .. 85½	Pomperairo.. 66½	Pomptina.... 57	Ponebat..... 47½	Ponteesas ... 38					
20	60	Pommes	90	Pomperont... 70	Pomptinos... 60	Ponederas ... 50	Ponteau..... 40				
21	63	Pommetier... 94½	Pompeux 73½	Pomptinum.. 63	Ponedera.... 52½	Ponteler	42				
22	66	Pommiers ... 99	Pompgast ... 77	Pompuster... 66	Ponederos ... 55	Pontgast 44					
23	69	Pomona	103½	Pompgoot ... 80½	Pomunus 69	Ponencias.... 57½	Pontgeld.... 46				
24	72	Pomonale ... 108	Pomphaft.... 84	Pomusculi ... 72	Ponendos.... 60	Ponticani.... 48					
25	75	Pomonalis ... 112½	Pomphamer.. 87½	Ponamus..... 75	Ponente..... 62½	Pontibus.... 50					
26	78	Pomones	117	Pompicos.... 91	Poncella 78	Ponentello... 65	Ponticello... 52				
27	81	Pomosos..... 121½	Pompicun.... 94½	Ponceux..... 81	Ponentina.... 67½	Ponticche.... 54					
28	84	Pomosum.... 126	Pompilia 98	Ponchadas... 84	Ponevano.... 70	Ponticulos ... 56					
29	87	Pomoyer..... 130½	Pompilites... 101½	Pandaision .. 87	Pongamos ... 72½	Pontifex..... 58					
30	90	Pompobar ... 135	Pompilo 105	Ponderador.. 90	Pongolam.... 75	Pontifice.... 60					
Approximate weight per square foot, lbs.			7	7	7	7	7
List per square foot....			\$0.4142465057

Water Radiators tapped 2-inch Top and Bottom one end, 2-inch opposite end. Steam Radiator tapped 2-inch Bottom, each end. The Return Ends Section tapped for Air Valves, ½-inch Steam or Water.

* Add 1½ inches to total length for Radiator Bushings.
 See pages 458 and 459 for Regular Tappings.

In Orders and Specifications give Plate Numbers and Number of Sections.

SCEPTER RADIATORS.

STEAM ONLY.

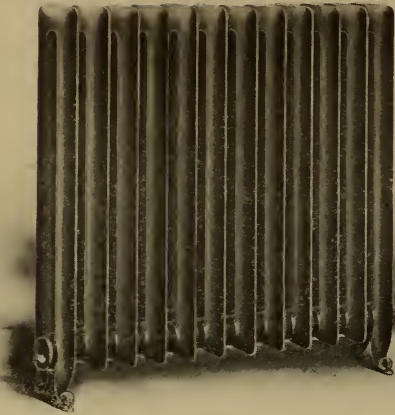

1662-C.



1663-C.

Dimensions of Section:

Total width at floor.....7 inches.
 Width of section.....7 “
 Length per section.....2¾ “

RADIATING SURFACE (Square Feet).

No. of Sections.	*Total Length, Inches.	Code.	44 Inches High.	Code.	38 Inches High.	Code.	30 Inches High.	Code.	24 Inches High.	Code.	18 Inches High.
2	4¾	Pontifigue....	9½	Popeshys.....	8	Poppejnik....	6	Porbeagle....	4⅔	Porgebaris...	3⅓
3	7⅞	Pontilha.....	14¼	Popinabor ...	12	Popellina....	9	Porcaco.....	7	Porgendo.....	5
4	9½	Pontilibus....	19	Popinale.....	16	Poppengek... 12	Porcalhao....	9⅓	Porgesse.....	6⅔	
5	11⅞	Pontils.....	23¾	Popinette....	20	Poppemhd... 15	Porcallon....	11⅔	Porgevate....	8⅓	
6	14¼	Pontofilo....	28½	Popingays ...	24	Poppenkast.. 18	Porcastro....	14	Porgimur ...	10	
7	16¾	Pontones....	33¼	Popinjay....	28	Poppenspel.. 21	Porcastro....	16⅓	Porgitore....	11⅔	
8	19	Pontonibus..	38	Popinone....	32	Popperig....	Porcated....	18⅔	Porgunt.....	13⅓	
9	21¾	Pontoons....	42¾	Popish.....	36	Poppese.....	Porcebitis... 21	Porcillio....	15		
10	23¾	Pontuali....	47½	Poplared....	40	Popples	Porcebunt... 23⅓	Porismato... 16⅔	Porismato... 16⅔		
11	26½	Poodles.....	52¼	Popletem ...	44	Poppuzza....	Porcelana.... 25⅔	Porisme....	18⅓		
12	28½	Poolkat.....	57	Popletibus ..	48	Poppysme... 36	Porcellion... 28	Porkers.....	20		
13	30¾	Poorhouse ...	61¾	Poplicolis... 52	Poppyzon.... 39	Porcendos... 30⅓	Porcetra 32⅔	Porkling....	21⅔		
14	33¼	Poorliness... 66½	Poplicum.... 56	Populabar... 42	Populacac... 45	Porchetta ... 35	Porcilio....	42	Poroderme... 26⅔		
15	35¾	Poorly.....	71¼	Poplital....	60	Populacac... 45	Porcilio....	42	Porodozio... 28⅓		
16	38	Popabais....	76	Poplital....	64	Populaire... 48	Porciano ... 37⅓	Porofillo... 30	Porofillo... 30		
17	40¾	Popadora... 80¾	Poploe.....	68	Popular....	51	Porcile.....	39⅔	Poroforo... 31⅔		
18	42¾	Popamiento. 85½	Poplorum... 72	Populated... 54	Populated... 54	Porcilia....	Porcilio....	42	Poronfalo... 33⅓		
19	45⅞	Popamos....	90¼	Popolando... 76	Populator... 57	Porcone.....	Porcone....	44⅓	Poroforo... 31⅔		
20	47½	Popanorum... 95	Popolata ... 80	Popolarit... 60	Popolarit... 60	Porculator... 46⅔	Porculator... 46⅔	Poronfalo... 33⅓			
21	49¾	Popanum....	99¾	Popolazzo... 84	Populeone... 63	Porcunos ... 49	Porcunos ... 49	Poronia....	35		
22	52¼	Popar.....	104½	Popolino....	88	Populeux....	Porcupine... 51⅓	Pororaca ... 36⅔	Pororaca ... 36⅔		
23	54¾	Popares....	109¼	Popolosa....	92	Populina....	Pordenone... 53⅔	Porosas....	38⅓		
24	57	Poparemos.. 114	Popone.....	96	Populneos... 72	Poreblind... 56	Poreblind... 56	Poroselene... 40	Poroselene... 40		
25	59¾	Poparon....	118¾	Poponessa ... 100	Populneum.. 75	Poreusis....	Poreusis....	58⅓	Porotelio... 41⅔		
26	61¾	Popedon....	123½	Poponide....	104	Poreux.....	Poreux.....	60⅔	Porothele... 43⅓		
27	64¾	Popewood... 128¼	Poppando... 108	Populosite... 81	Populosite... 81	Porfialais... 63	Porfialais... 63	Porously ... 45	Porously ... 45		
28	66½	Popeline....	133	Popparono... 112	Poquettes ... 84	Porfiar.....	Porfiar.....	65⅓	Porpague... 46⅔		
29	68¾	Popellos....	137¾	Poppatola... 116	Poquitos ... 87	Porfidios... 67⅔	Porfidios... 67⅔	Porpesse... 48⅓	Porpesse... 48⅓		
30	71¼	Popery.....	142½	Poppavate... 120	Poranes 90	Porfiosas... 70	Porfiosas... 70	Porpezite... 50	Porpezite... 50		
Approximate Weight per square foot, lbs.		7	7	7	7	7	
List per square foot....	\$0.4142465058		

Distance from Floor to Center Regular Tapping (all heights and sizes) 5 inches.
 Tapped 2-inch Supply and 2-inch Return, Bottom only. The Return End Section tapped for Air Valves, ½-inch.
 *Add 1½ inches to total length for Radiator Bushings.
 See pages 458 and 459 for Regular Tappings.

In Orders and Specifications give Plate Numbers and Number of Sections.

SOVEREIGN UNION.

GOLD PIN.

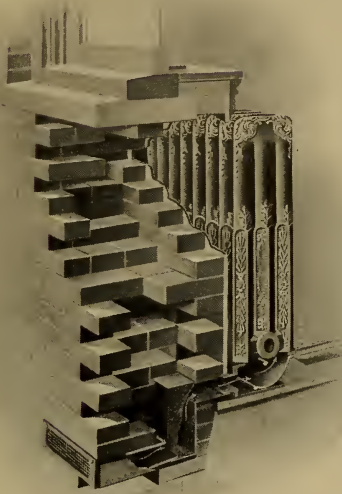

1664-C.

Direct-Indirect Radiators. Steam or Water.

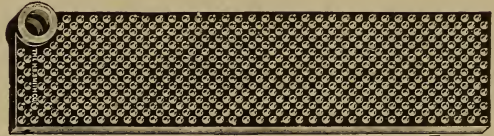

1665-C.

Indirect Radiators. Steam Only.

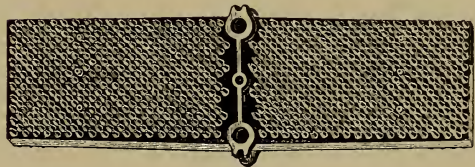

1666-C.

Indirect Radiators. Steam or Water.

X-RAY WALL RADIATORS.

STEAM OR WATER.

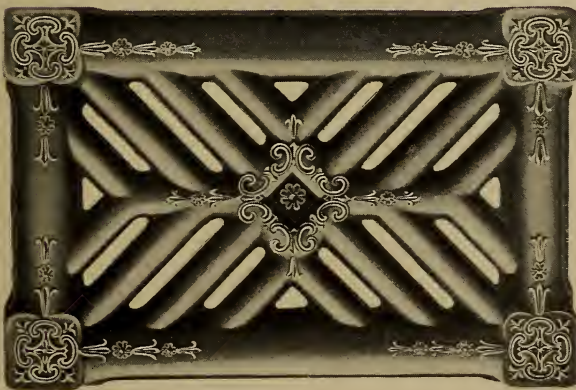

1666-C.

8-Foot.

8 Square Feet Per Section.



1667-C.

5-Foot.

5 Square Feet Per Section.

Send for Special Catalogue on Style of Radiation desired.

In Orders and Specifications give Plate Numbers and Number of Sections.

REGULAR TAPPING FOR DIRECT RADIATORS.

STEAM.

Radiators will be Tapped for Two-Pipe work unless otherwise specified.

TWO-PIPE WORK.

Radiators of 50 square feet and smaller1 inch x $\frac{3}{4}$ inch, Right Hand
 Radiators larger than 50 square feet.....1 $\frac{1}{4}$ " x 1 " " "
 Air Valves..... $\frac{1}{8}$ " Right Hand.

ONE-PIPE WORK.

Radiators of 30 square feet and smaller.....1 inch, Right Hand
 Radiators larger than 30 square feet and smaller than 60 square feet.....1 $\frac{1}{4}$ " " "
 Air Valves..... $\frac{1}{8}$ " " "

WATER.

Radiators of 50 square feet and smaller.....1 inch x 1 inch, Right Hand
 Radiators larger than 50 square feet1 $\frac{1}{4}$ " x 1 $\frac{1}{4}$ " " "
 Air Valves..... $\frac{1}{8}$ " at top, " "

If Radiators are required tapped top and bottom, same end or top and bottom, opposite ends, so specify on order.

DISTANCE FROM FLOOR TO CENTER. REGULAR TAPPINGS.

Regular Tapping, Inches.	Royal Union, 44, 38, 30, 24 and 18 Inches High.	Imperial Union. 45, 37, 31, 25 and 19 Inches High.
2	4 $\frac{5}{8}$ inches	4 $\frac{5}{8}$ inches
1 $\frac{1}{2}$	4 $\frac{5}{8}$ "	4 $\frac{5}{8}$ "
1 $\frac{1}{4}$	4 $\frac{5}{8}$ "	4 $\frac{5}{8}$ "
1	4 $\frac{5}{8}$ "	4 $\frac{5}{8}$ "
$\frac{3}{4}$	4 $\frac{5}{8}$ "	4 $\frac{5}{8}$ "
$\frac{1}{2}$	4 $\frac{5}{8}$ "	4 $\frac{5}{8}$ "

Regular Tapping, Inches.	Princess Union, 45, 37, 31, 25 and 19 Inches High.	Coronet, 45, 37, 31, 25 and 19 Inches High.	Diadem, 45, 37, 31, 25 and 19 Inches High.	Scepter, 44, 38, 30, 24 and 18 Inches High.
2	4 $\frac{11}{16}$ inches	4 $\frac{3}{16}$ inches	4 $\frac{3}{16}$ inches	5 inches
1 $\frac{1}{2}$	4 $\frac{9}{16}$ "	4 $\frac{1}{16}$ "	4 $\frac{1}{16}$ "	5 "
1 $\frac{1}{4}$	4 $\frac{7}{16}$ "	3 $\frac{15}{16}$ "	3 $\frac{15}{16}$ "	5 "
1	4 $\frac{5}{16}$ "	3 $\frac{13}{16}$ "	3 $\frac{13}{16}$ "	5 "
$\frac{3}{4}$	4 $\frac{3}{16}$ "	3 $\frac{11}{16}$ "	3 $\frac{11}{16}$ "	5 "
$\frac{1}{2}$	4 $\frac{1}{16}$ "	3 $\frac{9}{16}$ "	3 $\frac{9}{16}$ "	5 "

Send for Special Catalogue of Radiators.

In Orders and Specifications give Plate Numbers and Number of Sections.

APPROXIMATE DISTANCE FROM FLOOR TO CENTER OF TOP OPENINGS.

FOR RADIATORS TAPPED TOP AND BOTTOM SAME END, OR TOP AND BOTTOM OPPOSITE END.

IMPERIAL UNION.

Height of Radiator, inches.....	45	37	31	25	19
Approximate Distance from Floor to Center of Top Openings, inches.....	43	$35\frac{1}{16}$	$29\frac{1}{16}$	23	$17\frac{3}{16}$

PRINCESS UNION.

Height of Radiator, inches.....	45	37	31	25	19
Approximate Distance from Floor to Center of Top Openings, inches.....	$42\frac{1}{16}$	$34\frac{3}{4}$	$28\frac{5}{16}$	$22\frac{7}{8}$	$16\frac{5}{16}$

CORONET.

Height of Radiator, inches.....	45	37	31	25	19
Approximate Distance from Floor to Center of Top Openings, inches.....	$42\frac{3}{8}$	$34\frac{1}{8}$	$28\frac{1}{8}$	$22\frac{1}{4}$	$16\frac{5}{16}$

DIADEM.

Height of Radiator, inches.....	45	37	31	25	19
Approximate Distance from Floor to Center of Top Openings, inches.....	$42\frac{1}{4}$	$33\frac{5}{16}$	$28\frac{1}{8}$	$22\frac{1}{4}$	$16\frac{1}{4}$

ROYAL UNION FOR WATER.

Height of Radiator, inches.....	44	38	30	24	18
Approximate Distance from Floor to Center of Top Openings, inches.....	$41\frac{5}{16}$	$35\frac{7}{16}$	$27\frac{5}{16}$	$21\frac{3}{4}$	$15\frac{7}{8}$

NOTICE.

If a Water Radiator is to be used for steam warming, the Air Valve must be placed at the return end of the Radiator and near the bottom. Steam Radiators cannot be used for Water Warming.

Send for Catalogue of Radiators and Boilers.

In Orders and Specifications give Plate Numbers and Number of Sections.

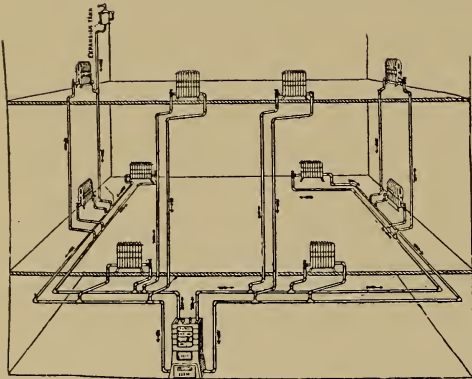

Illustrating a house system of Direct Hot Water Heating, showing flow and return pipes from the heater to the various radiators on two floors above.

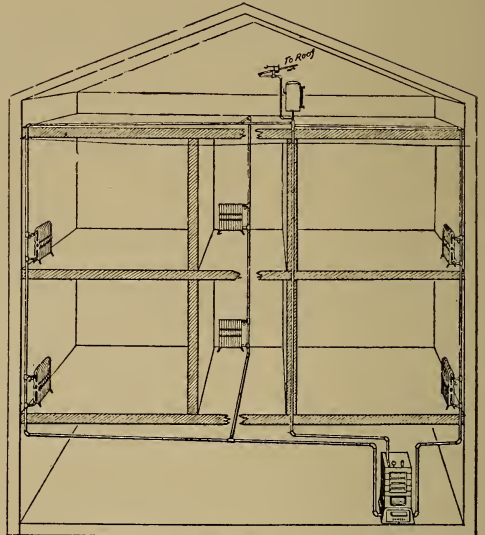

Illustrating an overhead feed system of Hot Water Heating. In this method of water heating, the flow-pipe is at once taken to a point in the attic for distribution, and all radiators fed by the fall of the water due to the cooling in the radiators.

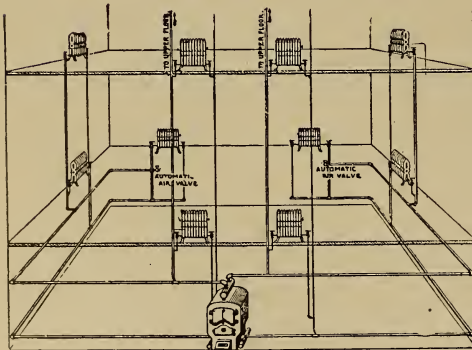

Illustrating a single pipe Steam Heating System, as applied to a residence of two floors. The extreme simplicity of this system will be appreciated.

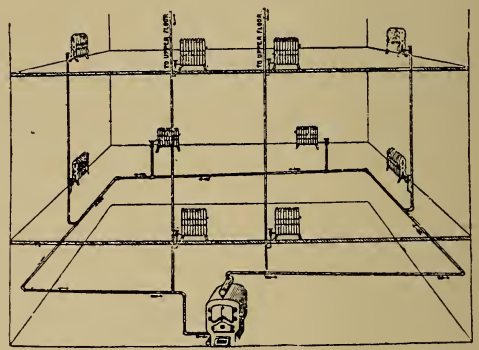

Illustrating a two pipe system of Steam Heating, adapted only for large buildings extending over large areas or for a residence where indirect radiation is used.

The above illustrations represent, in a small way, the two systems of direct Hot Water and Steam, that are almost universally used for house heating.

SECTION 7.

LEAD TRAPS, BENDS,

PLUMBERS' BRASS GOODS,

BIBBS, COCKS,

VALVES, WATER METERS, ETC.

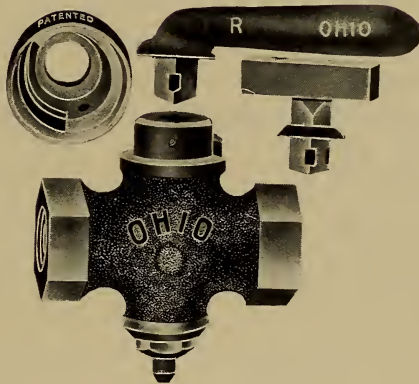

HOLBROOK, MERRILL & STETSON,

INCORPORATED.

SAN FRANCISCO, LOS ANGELES AND NEW YORK.

Drawn Lead Traps and Bends, equal in **appearance, outline** and **quality** to any in the market. The trap and vent screws are secured to the lead in such a manner that a **perfect** and **permanent joint** is assured, they do not project on inside of trap, consequently a **full, clear waterway** is obtained.

Fuller, Compression and **Ground Key Work** are the best standard grade goods obtainable.

Monarch Pattern Goods are made of best quality **red metal**. They are heavy, unique and artistic in design; highly polished and nickel-plated.

Ludlow Gate Valves are the best that can be produced, as to design, material and workmanship.

In ordering goods from this section by telegraph it is only necessary to use the code word over, or opposite the number or name of article wanted, preceded by words from code in front of catalogue.

Example: Crosistas one Prodiggally.

Translation: Ship by railroad immediately one three-inch Plain Running Lead Trap.

DRAWN LEAD TRAPS AND BENDS.

APPEARANCE, OUTLINE AND QUALITY EQUAL TO ANY ON THE MARKET.

The Trap and Vent Screws are secured to the lead in such a manner that a **perfect** and **permanent joint** is assured—they do not project on inside of trap, consequently a **full, clear waterway** is obtained.

On the following pages are catalogued our regular stock sizes of Lead Traps and Bends. We carry besides those shown, many odd lengths and can furnish on short notice, in regular sizes, 1¼, 1½, 2, 3, 4 or 4½-inch traps of any length or style in either Standard, Medium or Extra Heavy weight.

STOCK PACKAGES CARRIED IN STOCK READY FOR SHIPMENT.

Number of Regular Traps Plain and Vented, in a Barrel.

	1¼-Inch.		1½-Inch.		2-Inch.		3-Inch.	4-Inch.
	Plain.	Vented.	Plain.	Vented.	Plain.	Vented.	Plain.	Plain.
Full S.....	75	50	50	36	25	20	10	6
¼ S.....	75	50	50	36	25	20	10	6
½ S or P.....	75	50	50	36	25	25	12	8
Running.....	100	72	72	50	36	24	22	12
Extra long S.....	24	24	15
Extra long P.....	30	24	15
Short Bends.....	150	76	60	22	18
Long Bends.....	100	46	36	18	13

Shipping measurement per barrel, 5½ cubic feet.

Table Showing Additional Price Per Inch for Special Length Traps or Bends.

Weight of Lead per Running Foot.	STANDARD WEIGHT.				
	1½-Lb.	2¼-Lb.	3¼-Lb.	5-Lb.	6-Lb.
	1¼-Inch.	1½-Inch.	2-Inch.	3-Inch.	4-Inch.
For each inch of excess length over listed size, on any shape of Trap or Bend, add to the list of nearest listed size.....	\$0.03½	.04½	.06¼	.10¾	.12

Dimension Scales and special price list of Traps and Bends furnished on application.

In Orders and Specifications give Plate Numbers and Sizes.

DRAWN LEAD TRAPS.

PLAIN.

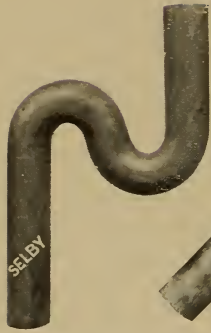

1700-C.
Plain "S" Trap.

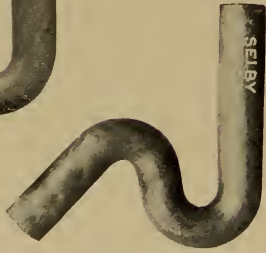

1701-C.
Plain 3/4 "S" Trap.



1702-C.
Plain "P" Trap.



1703-C.
Plain Running Trap.

PLAIN "S" TRAPS—1700-C.

Code.....	Prodambulo	Prodded	Prodding	Prodebar	Prodeggia
Inches.....	† 1¼	† 1½	† 2	3	4
Length of inlet and outlet, inches.....	4¼ inlet, 6¼ outlet	4½ inlet, 7 outlet	4½ inlet, 8 outlet	4 inlet, 10½ outlet	3¼ inlet, 11½ outlet
Weight of lead per running foot, lbs.....	1½	2¼	3¼	5	6
Each.....	\$0.48	.80	1.28	2.69	3.25
Weight each, lbs.....	2½	3¾	6½	12½	17½

PLAIN 3/4 "S" TRAPS—1701-C.

Code.....	Prodendos	Prodestis
Inches.....	3	4
Length of inlet and outlet, inches.....	4 inlet, 10 outlet	3¼ inlet, 11 outlet
Weight of lead per running foot, lbs.....	5	6
Each.....	\$2.62	3.07
Weight each, lbs.....	12½	17

PLAIN "P" TRAPS—1702-C.

Code.....	Prodeunt	Prodezza	Prodicao	Prodicella	Prodigaba
Inches.....	† 1¼	† 1½	† 2	3	4
Length of inlet and outlet, inches.....	4½ inlet, 6 outlet	4½ inlet, 7 outlet	4½ inlet, 8 outlet	4 inlet 9½ outlet	3¼ inlet, 10 outlet
Weight of lead per running foot, lbs.....	1½	2¼	3¼	5	6
Each.....	\$0.41	.65	1.10	2.24	2.49
Weight each, lbs.....	2½	3	5	...	11½

PLAIN RUNNING TRAPS—1703-C.

Code.....	Prodigally	Prodigar
Inches.....	† 3	† 4
Length of inlet and outlet, inches.....	7½ inlet, 7½ outlet	8 inlet, 8 outlet
Weight of lead per running foot, lbs.....	5	6
Each.....	\$2.09	2.53
Weight each, lbs.....	10½	14

For price of Traps with longer or shorter inlets or outlets, see page 463.

For stock packages, see page 463.

† Carried in San Francisco only.

In Orders and Specifications give Plate Numbers and Sizes

DRAWN LEAD TRAPS.

WITH BRASS DRAIN SCREWS.

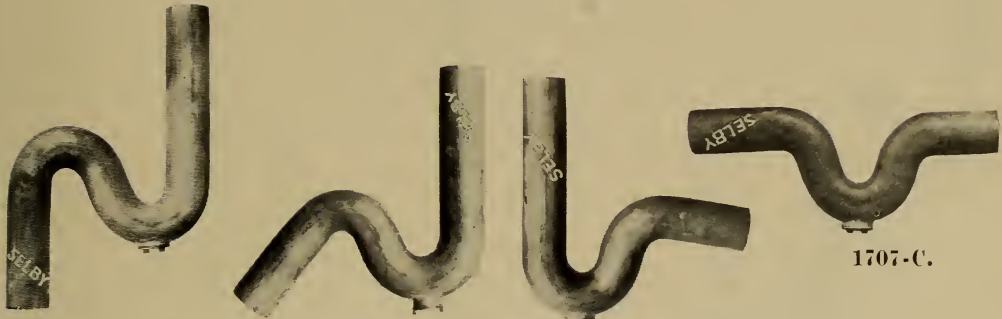

1704-C.

"S" Trap with Screw.

1705-C.

$\frac{3}{4}$ "S" Trap with Screw.

1706-C.

$\frac{1}{2}$ "S" or "P" Trap with Screw.

1707-C.

Running Trap with Screw.

"S" TRAP WITH SCREW—1704-C.

Code	Prodige	Prodigence	Prodigio
Inches	1 $\frac{1}{4}$	1 $\frac{1}{2}$	2
Length of inlet and outlet, inches.....	4 $\frac{1}{4}$ inlet, 6 $\frac{1}{4}$ outlet	4 $\frac{1}{2}$ inlet, 7 outlet	4 $\frac{1}{2}$ inlet, 8 outlet
Weight of lead per running foot, lbs.....	1 $\frac{1}{2}$	2 $\frac{1}{4}$	3 $\frac{1}{4}$
Each.....	\$0.58	.90	1.38
Weight each, lbs.....	2 $\frac{1}{2}$	3 $\frac{5}{8}$	6 $\frac{1}{2}$

$\frac{3}{4}$ "S" TRAP WITH SCREW—1705-C.

Code	Prodigious	Prodigitas	Prodiguer
Inches	1 $\frac{1}{4}$	†1 $\frac{1}{2}$	2
Length of inlet and outlet, inches.....	4 $\frac{1}{4}$ inlet, 5 $\frac{1}{4}$ outlet	4 $\frac{1}{2}$ inlet, 6 outlet	4 $\frac{1}{2}$ inlet, 7 $\frac{1}{2}$ outlet
Weight of lead per running foot, lbs.....	1 $\frac{1}{2}$	2 $\frac{1}{4}$	3 $\frac{1}{4}$
Each.....	\$0.55	.81	1.30
Weight each, lbs.....	2 $\frac{1}{2}$	3 $\frac{5}{8}$	6 $\frac{1}{2}$

$\frac{1}{2}$ "S" OR "P" TRAP WITH SCREW—1706-C.

Code	Prodissimo	Prodition	Proditor
Inches	1 $\frac{1}{4}$	1 $\frac{1}{2}$	2
Length of inlet and outlet, inches.....	4 $\frac{1}{2}$ inlet, 6 $\frac{1}{4}$ outlet	4 $\frac{1}{2}$ inlet, 7 outlet	4 $\frac{1}{2}$ inlet, 8 outlet
Weight of lead per running foot, lbs.....	1 $\frac{1}{2}$	2 $\frac{1}{4}$	3 $\frac{1}{4}$
Each.....	\$0.51	.75	1.20
Weight each, lbs.....	2 $\frac{1}{8}$	3	5

RUNNING TRAP WITH SCREW—1707-C.

Code	Proditrix	Prodituros	Produxero
Inches	†1 $\frac{1}{4}$	†1 $\frac{1}{2}$	†2
Length of inlet and outlet, inches.....	4 $\frac{1}{2}$ inlet, 5 $\frac{1}{2}$ outlet	5 $\frac{1}{4}$ inlet, 6 $\frac{1}{4}$ outlet	5 $\frac{1}{4}$ inlet, 7 $\frac{1}{2}$ outlet
Weight of lead per running foot, lbs.....	1 $\frac{1}{2}$	2 $\frac{1}{4}$	3 $\frac{1}{4}$
Each.....	\$0.48	.72	1.13
Weight each, lbs.....	2	2 $\frac{5}{8}$	4 $\frac{3}{4}$

For price of Traps with longer or shorter inlets or outlets, see page 463.

For stock packages, see page 463.

†Carried in San Francisco only.

In Orders and Specifications give Plate Numbers and Sizes.

DRAWN LEAD TRAPS.

WITH BRASS DRAIN SCREWS.

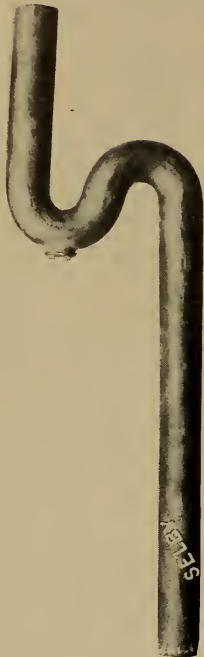

1708-C.
Long Outlet "S" Trap.



1709-C.
Long Inlet "S" Trap.

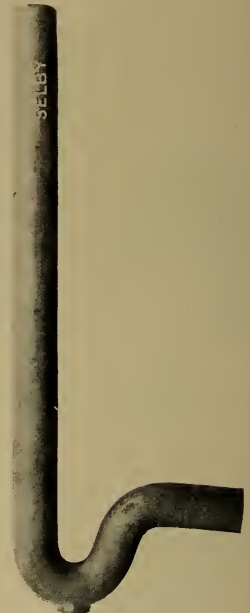

1710-C.
Long Inlet "P" Trap.

LONG OUTLET "S" TRAPS—1708-C.

Code.....	Prodoceas	Prodocemam	Prodocebis
Inches	1¼ -0	1½ -0	†2-0
Length of inlet and outlet, inches.....	4¼ inlet, 19¾ outlet	4½ inlet, 19½ outlet	4½ inlet, 19½ outlet
Weight of lead per running ft., lbs.....	1½	2¼	3¼
Each	\$0.93	1.36	2.00
Weight each, lbs.....	4¼	5½	9¾

LONG INLET "S" TRAPS—1709-C.

Code.....	Prodocebor	Prodocemus	Prodocenda
Inches	†1¼ -I	†1½ -I	†2-I
Length of inlet and outlet, inches.....	17¾ inlet, 6¼ outlet	17 inlet, 7 outlet	16 inlet, 8 outlet
Weight of lead per running ft., lbs.....	1½	2¼	3¼
Each.....	\$0.93	1.36	2.00
Weight each, lbs.....	4½	5½	9

LONG INLET "P" TRAPS—1710-C.

Code.....	Prodoceo	Prodormos	Prodonties
Inches	†1¼ -I	1½ -I	†2-I
Length of inlet and outlet, inches.....	17¾ inlet, 6 outlet	17 inlet, 7 outlet	16 inlet, 8 outlet
Weight of lead per running ft., lbs.....	1½	2¼	3¼
Each.....	\$0.76	1.02	1.55
Weight each, lbs.....	3½	5	8

LONG OUTLET "P" TRAPS—1711-C.

Code.....	Prodormies	Prodormio	Prodormico
Inches	†1¼ -0	†1½ -0	†2-0
Length of inlet and outlet, inches.....	4¼ inlet, 14¼ outlet	4½ inlet, 14 outlet	4½ inlet, 14 outlet
Weight of lead per running ft., lbs.....	1½	2¼	3¼
Each	\$0.76	1.02	1.55
Weight each, lbs.....	3½	4½	7½

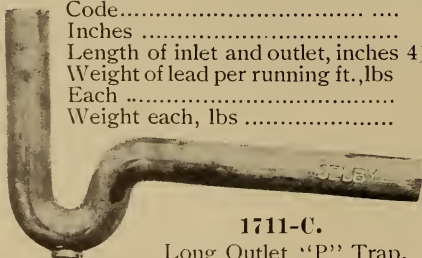

1711-C.
Long Outlet "P" Trap.

For price of Traps of different lengths of Inlets and Outlets, see page 463.

For stock packages, see page 463.

†Carried in San Francisco only.

In Orders and Specifications give Plate Numbers and Sizes.

DRAWN LEAD TRAPS.

WITH BRASS VENT COUPLINGS.

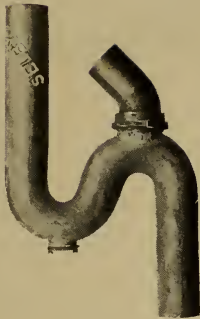

†1712-C.

“S” Trap with 1/8 Bend Brass Vent Coupling.



†1713-C.

“P” Trap with 1/8 Bend Brass Vent Coupling.

“S” TRAPS WITH BRASS VENT COUPLING—1712-C.

Code.....	Prodomo	Produceao	Producebas
Inches.....	1 1/4	1 1/2	2
Length of inlet and outlet, inches.....	4 1/4 inlet, 6 1/4 outlet	4 1/2 inlet, 7 outlet	4 1/2 inlet, 8 outlet
Weight of lead per running foot, lbs.....	1 1/2	2 1/4	3 1/4
Vent, inches.....	1 1/4	1 1/2	1 1/2
Each.....	\$1.73	2.31	2.95
Weight each, lbs.....	2 3/4	4 3/8	7 1/4

“P” TRAPS WITH BRASS VENT COUPLING—1713-C.

Code.....	Producecur	Produceente	Produceabo
Inches.....	1 1/4	1 1/2	2
Length of inlet and outlet, inches.....	4 1/2 inlet, 6 outlet	4 1/2 inlet, 7 outlet	4 1/2 inlet, 8 outlet
Weight of lead per running foot, lbs.....	1 1/2	2 1/4	3 1/4
Vent, inches.....	1 1/4	1 1/2	1 1/2
Each.....	\$1.56	1.97	2.50
Weight each, lbs.....	2 5/8	3 5/8	5 3/4



†1720-C.

LEAD DRUM TRAPS.

Code.....	Productivo	Producto	Productora
Style.....	Rough Brass	Polished Brass	Nickel-Plated Brass
Size, inches.....	Screw 4x10	Screw 4x10	Screw 4x10
Each.....	\$2.01	2.21	2.31
Weight each, lbs.....

Twenty-five in a barrel.

† Carried in San Francisco only.

In Orders and Specifications give Plate Numbers and Sizes.

DRAWN LEAD BENDS.



1723-C.
Short Lead Bend.



1724-C.
Short Inlet Extension Lead Bend.

SHORT LEAD BEND—1723-C.

Code.....	Produisant	Produit	Produjera	Produjeron	Produjeses
Inches.....	†1¼	†1½	†2	†3	†4
Center to ends, inches.....	6x3½	7x4	7¾x3¾	8¼x4¼	10x5½
Weight of lead per running foot, lbs.....	1½	2¼	3¼	5	6
Each.....	\$0.25	.38	.57	1.09	1.50
Weight each, lbs.....	1¾	2	3	7¾

4-INCH SHORT INLET EXTENSION LEAD BENDS—1724-C.

Code.....	Produxeris	Produzcan	Prozido	Prozudione	Prozuzir
Inches.....	†5½x12	†5½x15	†5½x16	†5½x18	†5½x20
Weight of lead per running foot, lbs.....	6	6	6	6	6
Each.....	\$1.70	2.00	2.12	2.30	2.48
Weight each, lbs.....	8¼	9¾	10¼	11¾	12¾

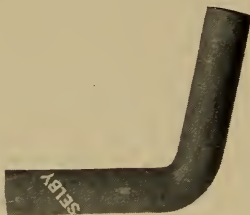

1725-C.
Long Lead Bend.

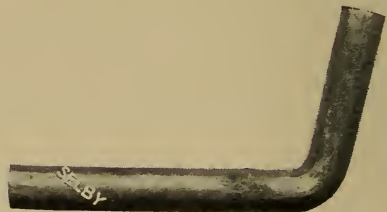

1726-C.
Long Inlet Extension Lead Bend.

LONG LEAD BENDS—1725-C.

Code.....	Proebeln	Proebelst	Proefgeta	Proefglas	Proefgoud
Inches.....	†1¼	†1½	†2	†3	†4
Center to ends, inches.....	6x6	7x7	7¾x7¾	8¼x8¼	10x10
Weight of lead per running foot, lbs.....	1½	2¼	3¼	5	6
Each.....	\$0.30	.50	.78	1.39	1.95
Weight each, lbs.....	1½	2¼	4	9¾

4-INCH LONG INLET EXTENSION LEAD BENDS—1726-C.

Code.....	Proeflood	Proefmaat	Proefrit	Proefschot	Proefslag
Inches.....	†10x12	†10x14	†10x15	†10x18	†10x20
Weight of lead per running foot, lbs.....	6	6	6	6	6
Each.....	\$2.15	2.39	2.44	2.73	2.92
Weight each, lbs.....	11	11½	12	13½	14½

For price of Bends with longer or shorter Inlets or Outlets, see page 463.

For stock packages, see page 463.

Dimension Scales and price list of lead bends furnished on application.

†Carried in San Francisco only.

In Orders and Specifications give Plate Numbers and Sizes.

COMBINATION LEAD AND IRON FERRULES.

FOR CONNECTING LEAD TO CAST IRON SOIL PIPE.

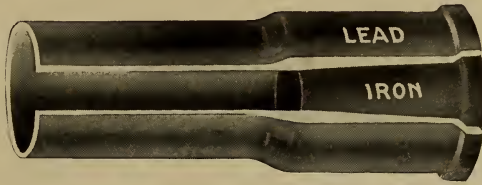

†1730-C.

FOR 1 1/2-INCH LEAD PIPE AND 2-INCH CAST IRON PIPE.

Code	Proefspel	Proefstoot	Proefstuk
Inches.....	1 1/2x2x4	1 1/2x2x6	1 1/2x2x8
Each	\$0.28	.43	.51
Weight each, lbs.....	1 3/8	1 3/4	2

FOR 2-INCH LEAD PIPE AND 2-INCH CAST IRON PIPE.

Code	Proeftegel	Proeftin	Proeftocht
Inches.....	2x4	2x6	2x8
Each	\$0.28	.46	.57
Weight each, lbs.....	1 1/2	2	2 1/2

FOR 3-INCH LEAD PIPE AND 3-INCH CAST IRON PIPE.

Code	Proejabo	Proejadora
Inches.....	3x4	3x6
Each	\$0.42	.67
Weight each, lbs.....	2 3/4	3 1/8

FOR 4-INCH LEAD PIPE AND 4-INCH CAST IRON PIPE.

Code	Proejamos	Proejar	Proejaron	Proejais	Proemes	Proemial	Proemiamk	Proemiato
Inches.....	4x4	4x6	4x8	4x10	4x12	4x14	4x16	4x18
Each	\$0.50	.85	1.02	1.25	1.40	1.60	1.73	1.85
Weight each, lbs.....	3 1/4	3 3/8	4 3/4	5 5/8	6 1/8	7 3/4	7 7/8	8

COMBINATION LEAD AND IRON BENDS AND FERRULES.

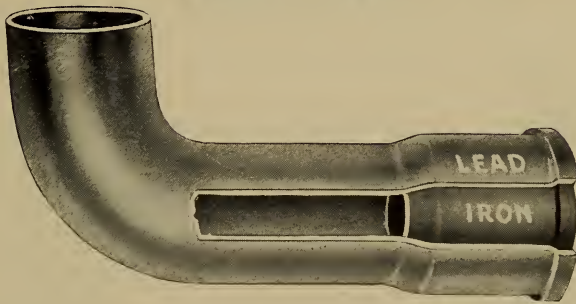

†1731-C.

FOR 4-INCH LEAD PIPE AND 4-INCH CAST IRON PIPE.

Code	Proemiava	Proemio	Proeti	Proetides	Proetos
Inches.....	4x12	4x14	4x15	4x16	4x18
Length of inlet, inches.....	5 1/2	5 1/2	5 1/2	5 1/2	5 1/2
Each	\$2.20	2.44	2.50	2.62	2.80
Weight each, lbs.....	10	10 1/2	11	11 1/2	12 1/2

Measurements are made on lines running exactly through centers of Inlet and Outlet, and intersecting one another at an angle of 90°

† Carried in San Francisco only.

In Orders and Specifications give Plate Numbers and Sizes.

COMBINATION LEAD AND BRASS SOLDER NIPPLES.

FOR CONNECTING LEAD AND STANDARD IRON PIPE.

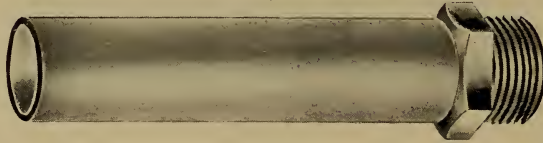

† 1733-C.

FOR 1/4-INCH LEAD PIPE WITH SPUD FOR 1/4-INCH IRON PIPE.

Code.....	Procevers	Proeza	Profabaris	Profabor
Inches.....	1/4x6	1/4x8	1/4x10	1/4x12
Each.....	\$0.44	.52	.58	.63
Weight each, lbs.....	1	1 1/2	1 3/4	2

FOR 1/2-INCH LEAD PIPE WITH SPUD FOR 1/2-INCH IRON PIPE.

Code.....	Profaca	Profamini	Profanaba	Profanar
Inches.....	1/2x6	1/2x8	1/2x10	1/2x12
Each.....	\$0.60	.66	.74	.80
Weight each, lbs.....	1 1/2	1 3/4	2 3/8	2 5/8

FOR 2-INCH LEAD PIPE WITH SPUD FOR 2-INCH IRON PIPE.

Code.....	Profanarla	Profanely	Profaning	Profauolla
Inches.....	2x6	2x8	2x10	2x12
Each.....	\$0.86	.96	1.08	1.17
Weight each, lbs.....	2	2 1/2	3	3 3/4

PLUMBERS' LEAD TACKS.



† 1735-C.

SINGLE.

Code.....	Profanorum
Per lb.....	\$0.15
Weight per pair, lbs.....



† 1736-C.

DOUBLE.

Code.....	Profazaban
Per lb.....	\$0.15
Weight each, lbs.....

† Carried in San Francisco only.

In Orders and Specifications give Plate Numbers and Sizes.

LEAD PIPE.

Code Word.	Calibre.	Thickness of Wall, Inch.	Weight, Per Foot.		Approx. Weight Coil, Lbs.	Approx. Weight Reel, Lbs.
			Lbs.	Ozs.		
Proferant	†AAA 3/8 in. ex. pressure.....	3-16	1	11	115	725
Proferian	†AA " ex. strong.....	5-32	1	5	90	725
Proferidos	A " strong.....	9-64	1	2	90	725
Proferimus	B " medium.....	1-8	1	0	90	725
Proferiste	C " light.....	3-32	0	13	60	700
Profertas	†D " fountain.....	3-32	0	10	60	700
Proferto	†AAA 1/2 in. ex. pressure.....	1-4	3	0	120	725
Profesa	AA " ex. strong.....	3-16	2	0	120	725
Profesais	A " strong.....	5-32	1	11	120	725
Profesante	B " medium.....	1-8	1	4	90	725
Professar	C " light.....	7-64	1	0	90	725
Professons	†D " fountain.....	5-64	0	12	60	725
Profetaran	†AAA 5/8 in. ex. pressure.....	17-64	3	8	170	725
Profetaste	†AA " ex. strong.....	7-32	2	12	170	725
Profetiche	A " strong.....	3-16	2	8	170	725
Profeticos	B " medium.....	5-32	2	0	112	725
Profetizo	C " light.....	9-64	1	11	90	700
Proffering	†D " ex. light.....	7-64	1	4	90	700
Profferta	†E " fountain.....	5-64	1	0	90	700
Proficisco	†AAA 3/4 in. ex. pressure.....	17-64	4	8	170	725
Proficuas	†AA " ex. strong.....	15-64	3	8	170	725
Proflait	A " strong.....	13-64	3	0	170	725
Profiling	B " medium.....	5-32	2	4	120	725
Profilist	C " light.....	5-32	2	1	112	700
Profitchen	†D " ex. light.....	1-8	1	10	90	700
Profiterdo	†E " fountain.....	3-32	1	4	90	700
Profitez	†AAA 1 in. ex. pressure.....	19-64	6	0	160	900
Profitons	†AA " ex. strong.....	1-4	4	12	160	800
Proflabis	†A " strong.....	7-32	4	0	160	800
Proflabo	†B " medium.....	11-64	3	4	160	800
Proflamen	C " light.....	9-64	2	8	160	800
Proflavero	D " ex. light.....	1-8	2	0	120	800
Proflictum	†E " fountain.....	3-32	1	8	90	725
Profligaba	†AAA 1 1/4 in. ex. pressure.....	9-32	7	9	290	925
Profligacy	†AA " ex. strong.....	1-4	5	12	160	900
Profligar	†A " strong.....	7-32	4	12	160	900
Profligues	†B " medium.....	11-64	3	12	160	900
Profligunt	†C " light.....	9-64	3	0	160	800
Profluence	†D " ex. light.....	7-64	2	8	140	800
Profluxero	E " fountain.....	3-32	2	0	112	800
Profluxit	†AAA 1 1/2 in. ex. pressure.....	5-16	8	8	290	925
Profond	†AA " ex. strong.....	17-64	7	4	260	925
Profondare	†A " strong.....	15-64	6	4	260	900
Profringe	†B " medium.....	3-16	5	0	160	900
Profudisti	†C " light.....	11-64	4	4	160	875
Profuga	†D " ex. light.....	9-64	3	8	160	875
Profughi	E " fountain.....	1-8	3	0	160	800
Profulgent	†AA 2 in. ex. strong.....	1-4	9	0	260	925
Profumata	†A " strong.....	13-64	7	0	260	900
Profumollo	†B " medium.....	3-16	6	0	160	875
Profumoso	†*C " light.....	5-32	5	4	160	875
Profundar	*D " ex. light.....	1-8	4	0	150	825

* In 10-foot lengths ; packed 8 lengths in a box.

Per pound.....\$.....
 Order Lead Pipe by letter and inches.

LEAD SOIL PIPE.

Code	Profusely	Profusive	Profusoris	Profusuram
Size, inches	†3	†3	4	†4
Thickness of wall, inches	5-64	3-32	5-64	3-32
Weight per foot, lbs.....	3 1/2	4 1/2	5	6
Per pound	\$.....

In 13-foot lengths.

Order Lead Soil Pipe by diameter and weight per foot or thickness.

† Carried in San Francisco only.

† **EX. HEAVY LEAD SOIL PIPE.**

Code Word.	Inside Diameter, Inches.	Thickness of Wall, Inch.	Weight Per Foot.		Code Word.	Inside Diameter, Inches.	Thickness of Wall, Inch.	Weight Per Foot.	
			Lbs.	Ozs.				Lbs.	Ozs.
Progemmes	2½	3-16	7	13	Prohigano	5	3-32	8	4
Progemmo	2½	1-4	11	0	Prohilare	5	1-8	10	0
Progenera	3	3-16	9	5	Prohilast	5	3-16	15	0
Progenitor	3	1-4	12	10	Prohilemmo	5	1-4	19	0
Progeny	3½	1-8	6	2	Prohilide	5½	3-16	16	0
Progeretis	3½	3-16	10	0	Prohilink	5½	1-4	20	8
Progero	3½	1-4	15	0	Prohilonge	6	3-32	9	12
Progerunt	4	1-8	8	0	Prohimort	6	1-8	13	4
Progressero	4	7-32	13	0	Prohimund	6	1-8	12	0
Progestabo	4	17-64	16	5	Prohinge	6	3-16	18	8
Progestura	4	19-64	20	0	Prohistory	6	17-64	26	0
Progetta	4½	3-16	14	0	Prohistrod	7	3-16	22	0
Proignes	4½	1-4	18	8	Prohitrask	7	1-4	26	0

Per pound.....\$.....
 Order Extra Heavy Lead Soil Pipe by diameter and weight per foot or thickness.

† **TIN PIPE.**

Code Word.	Inside Diam. Inch.	Ounces per Foot.	Thickness of Wall, Inch.	Lbs. in Coil.	Feet in Coil.	Code Word.	Inside Diam. Inch.	Ounces per Foot.	Thickness of Wall, Inch.	Lbs. in Coil.	Feet in Coil.
Proglottis.....	⅛	2	1-16			Prohiteem	½	9½	3-32	43	72
Prognare	¼	4	5-64	43	172	Prohitorch.....	⅝	10	3-32	65	104
Prognathe	¼	5	7-64	43	138	Prohoband.....	¾	12	3-32	83	110
Prognato	¼	6	7-64	43	115	Prohockit.....	¾	23	5-32	83	58
Prognidem	⅝	7	17-64			Prohodder	1	15	7-64	83	89
Prognidis	⅜	4	1-16	43	172	Prohoffs	1	20	7-64	83	66
Prognose	⅜	5	1-16	43	138	Prohoggish	1	34	11-64		
Prognostic.....	⅜	6	3-32	43	115	Prohogure	1¼	20	3-32	83	66
Programa	⅜	8½	3-32	43	81	Prohoiden	1½	28	7-64	83	50
Progresado	½	6	1-16	43	115	Prohoiland	2	42½	5-32		
Progresar	½	8	3-32	43	86						

Per pound.....\$.....
 Order Tin Pipe by inch and ounces.

SHEET LEAD.

Code Word.	Weight per sq. foot lbs.	Thickness Inch.	Code Word.	Weight per sq. foot lbs.	Thickness Inch.
Progesion.....	2½	5-128	Prohoimud	† 7	7-64
Progressif	3	3-64	Prohokund	† 8	1-8
Prohibe	†3½	7-128	Prohombre	† 9	9-64
Prohibida	4	1-16	Prohonest	†10	5-32
Prohibimos	†4½	9-128	Prohooper	†12	3-16
Prohibons	†5	5-64	Prohoppa.....	†16	1-4
Prohibute.....	6	3-32	Prohostess.....	†24	3-8

Per pound.....\$.....
 Regular Rolls of Sheet Lead are 8½ feet wide and 18 to 21 feet long.
 Order Sheet Lead by weight.

† **SHEET TIN.**

Code.....	Proiben
No. of Gauge.....	18
Pounds to square foot.....	2
Thickness, inches	1-20
Size, feet	7 x 14
Per pound	\$.....

We can furnish other sizes and thicknesses of sheet tin to order.
 † Carried in San Francisco only.

SOLDERING NIPPLES.

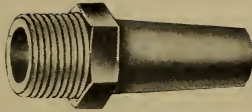

1740-C.
Male.

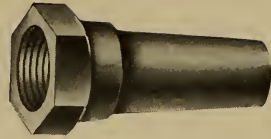

1741-C.
Female.

MALE SOLDERING NIPPLES—1740-C.

Code.....	Projectil	Projecto	Projektant	Projektons	Prokliden	Prokop	Prokruste
Size, inches.....	$\frac{3}{8}$	$\frac{1}{2}$	$\frac{3}{4}$	1	$1\frac{1}{4}$	$1\frac{1}{2}$	2
Per dozen.....	\$2.75	3.50	5.00	6.50	10.00	12.50	18.00
Weight per dozen, lbs.....	$1\frac{1}{8}$	2	3	$4\frac{1}{8}$	$6\frac{1}{2}$	$8\frac{1}{8}$	$12\frac{1}{8}$

One dozen in a package.

FEMALE SOLDERING NIPPLES—1741-C.

Code.....	Prohaberis	Prolapse	Prolasso	Prolate	Prolation	Prolativos	Prolativum
Size, inches.....	$\frac{3}{8}$	$\frac{1}{2}$	$\frac{3}{4}$	1	$1\frac{1}{4}$	$1\frac{1}{2}$	2
Per dozen.....	\$2.75	3.50	5.00	6.50	10.00	12.50	18.00
Weight per dozen, lbs.....	1	2	$2\frac{1}{2}$	$3\frac{1}{2}$	$5\frac{1}{4}$	8	11

One dozen in a package.

SOLDERING UNIONS.

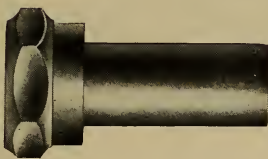

1742-C.
Straight.

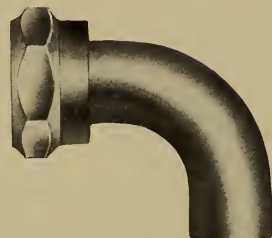

1743-C.
Bent.

STRAIGHT SOLDERING UNIONS—1742-C.

Code.....	Prolaus	Prolectes	Proliefed	Prolegat	Prolepsis	Proleptic
Size, inches.....	$\frac{1}{2}$	$\frac{3}{4}$	1	$1\frac{1}{4}$	$1\frac{1}{2}$	2
Per dozen.....	\$1.50	6.00	8.00	12.00	15.00	21.00
Weight per dozen, lbs.....	$1\frac{3}{4}$	$2\frac{3}{4}$	$3\frac{3}{4}$	$5\frac{1}{4}$	$6\frac{3}{4}$	$8\frac{1}{4}$

One dozen in a package.

BENT SOLDERING UNIONS—1743-C.

Code.....	Prolfaca	Prolibat	Prolifcar	Prolis	Prolixa	Prolixabo
Size, inches.....	$\frac{1}{2}$	$\frac{3}{4}$	1	$1\frac{1}{4}$	$1\frac{1}{2}$	2
Per dozen.....	\$6.50	9.00	11.00	16.00	22.00	30.00
Weight per dozen, lbs.....	$2\frac{1}{2}$	$3\frac{3}{4}$	$5\frac{1}{4}$	$7\frac{1}{2}$	$9\frac{1}{2}$	$11\frac{3}{4}$

One dozen in a package.

In Orders and Specifications give Plate Numbers and Sizes.

BOILER COUPLINGS.

BRASS. SPUD THREADED FOR 1-INCH IRON PIPE.

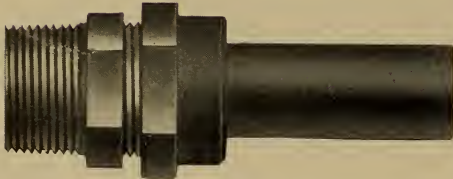

1745-C.

STRAIGHT FOR LEAD PIPE.

Code.....	Prolochus	Prolocutor
Style.....	Plain Face	Ground Face
Size, inches.....	3/4	3/4
Per dozen.....	\$8.00	9.00
Weight per doz., lbs.	6 1/2	6 1/2

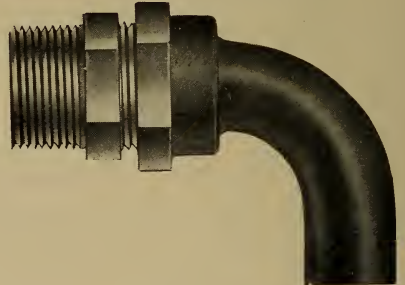

1746-C.

BENT FOR LEAD PIPE.

Code.....	Prologar	Prologato
Style.....	Plain Face	Ground Face
Size, inches.....	3/4	3/4
Per dozen.....	\$9.00	10.00
Weight per doz., lbs..	8 3/4	8 3/4

PER SET OF FOUR (TWO BENT, TWO STRAIGHT, ONE TAPPED SPUD).

Code.....	Prologium	Prologize
Style.....	Plain Face	Ground Face
Size, inches.....	3/4	3/4
Per set.....	\$2.85	3.20
Weight per set, lbs.....	2 1/2	2 1/2

Six sets in a box.

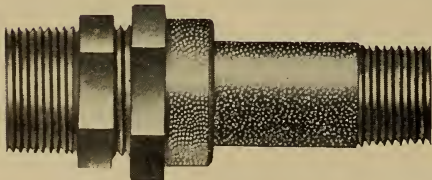

1747-C.

STRAIGHT FOR IRON PIPE.

Code.....	Prolonga	Prolonging
Style.....	Plain Face	Ground Face
Size, inches.....	3/4	3/4
Per dozen.....	\$10.00	11.00
Weight per doz., lbs..	7 1/4	7 1/4

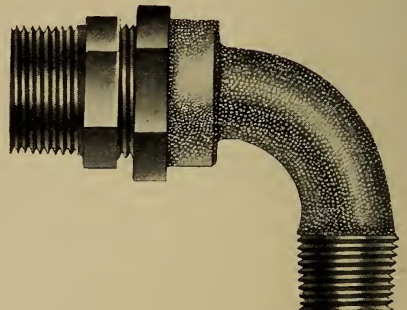

1748-C.

BENT FOR IRON PIPE.

Code.....	Prolubia	Prolubido
Style.....	Plain Face	Ground Face
Size, inches.....	3/4	3/4
Per dozen.....	\$11.00	12.00
Weight per doz., lbs..	9 1/4	9 1/4

PER SET OF FOUR (TWO BENT, TWO STRAIGHT, ONE TAPPED SPUD).

Code.....	Proludes	Proludunt
Style.....	Plain Face	Ground Face
Size, inches.....	3/4	3/4
Per set.....	\$3.50	3.85
Weight per set, lbs.....	2 7/8	2 7/8

Six sets in a box.

In Orders and Specifications give Plate Numbers and Sizes.

PLAIN COUPLINGS.

BRASS. PLAIN FACE. FOR LEAD PIPE.

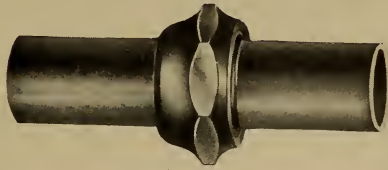

†1750-C.

Code.....	Prolugebo	Prolugemus	Prolugerem	Prolungare	Prolungo
Size, inches.....	¼	¾	½	¾	1
Per dozen.....	\$3.00	3.50	4.00	6.50	10.00
Weight per dozen, lbs.....	1⅛	2	2¾	5½	8

WASTES AND WASHERS.

BRASS. HEAD SCREWED FOR IRON PIPE.



†1751-C.
Bath.

Code.....	Prolusi	Prolusion	Proluturo
Size, inches.....	1¼	1½	2
Per dozen.....	\$9.00	12.00	15.00
Weight per doz., lbs....	6¼	9½	14½



†1752-C.
Tray or Tank.

Code.....	Promachos	Promagem	Promanabo
Size, inches.....	1¼	1½	2
Per dozen.....	\$10.00	17.00	21.00
Weight per doz., lbs....	8½	12	19

TRAP SCREWS.



1753-C.
Standard Trap Screw.

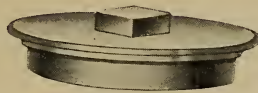

1754-C.
Nickel-Plated Trap Screw with
projecting flange 4 inch.
Per dozen \$35.00

DECK SCREWS.

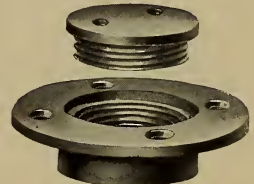

1755-C.
Finished Brass.

TRAP SCREWS—1753-C.

Size, Inches.	Weight Per Dozen, Lbs.	Finished.		† Nickel-Plated.	
		Code.	Per Dozen.	Code.	Per Dozen.
† ¾	1	Promanetis	\$2.25	Promergis	\$4.50
1	1¼	Promebaris	2.50	Promessa	5.00
1¼	2¾	Promediar	3.00	Prometian	6.00
1½	4¾	Promedio	4.00	Prometteur	7.50
2	5½	Promenade	7.00	Promettido	11.00
†2½	6½	Promeneur	10.00	Prometto	15.00
†3	9	Promeniez	15.00	Prominor	20.00
4	12¼	Promenores	20.00	Prominulos	26.00

†DECK SCREWS—1755-C.

Code.....	Promiscam	Promiscuo	Promission	Promissive	Promissos	Promitorem
Size, inches.....	1	1¼	1½	2	2½	3
Per dozen.....	\$10.00	12.00	14.00	18.00	24.00	33.00
Weight per dozen, lbs.....	6¾	12	13½	16	19	27

† Carried in San Francisco only.

In Orders and Specifications give Plate Numbers and Sizes.

BRASS FERRULES.

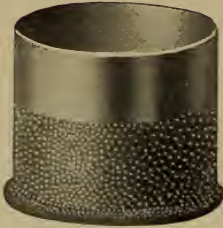

1760-C.
Plain Ferrule.



† **1761-C.**
Ferrule with Trap Screw.

PLAIN BRASS FERRULES—1760-C.

Code.....	Promoneo	Promonstra	Promontory	Promotion	Promotor
Size, inches.....	2	† 3	4	† 5	† 6
Per dozen.....	\$5.00	10.00	15.00	24.00	36.00
Weight per dozen, lbs.....	6½	12	18	25½	34

† **BRASS FERRULES WITH TRAP SCREW—1761-C.**

Code.....	Promotrice	Promotura	Promovebo	Promovents	Promover
Size, inches.....	2	3	4	5	6
Per dozen.....	\$10.00	18.00	24.00	48.00	69.00
Weight per dozen, lbs.....	9½	18	18½	52½	73



1762-C.

REDUCING FERRULE.

Code.....	Promovian	Promozione
Size, inches.....	† 2x1¼	2x1½
Per dozen.....	\$5.00	5.00
Weight per dozen, lbs.....	7¼	5¾



† **1763-C.**

BENT FERRULE.

Code.....	Promptabis	Promptamus
Size, inches.....	2	4
Per dozen.....	\$12.00	24.00
Weight per dozen, lbs.....	11	35

† Carried in San Francisco only.

In Orders and Specifications give Plate Numbers and Sizes.

IRON FERRULE.

WITH BRASS TRAP SCREW.



1764-C.

BRASS SLEEVE.

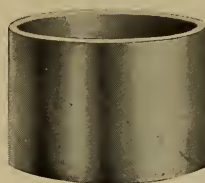

1765-C.

IRON FERRULE WITH BRASS TRAP SCREW—1764-C.

Code.....	Promptavit	Prompto	Promptulas
Size, inches.....	2	†3	4
Each.....	\$0.30	.40	.50
Weight each, lbs.....	1½	2	2¾

BRASS SLEEVES—1765-C.

Code.....	Prompture	Promulca	Promulgano	Promulge	Promulsum
Size, inches.....	†2	†3	4	†5	†6
Per dozen.....	\$4.00	8.00	10.00	25.00	34.00
Weight per dozen, lbs.....	4½	8¾	13	19½	26

THREADED BRASS COLLARS.

FOR CONNECTING BRASS TUBING OR LEAD PIPE TO IRON PIPE.



1767-C.

Code.....	Promunt	Promuras	Promutus
Size, ins.....	1¼x1¼	1½x1½	1½x1¼
Inside dia., ins.....	1¼	1½	1¼
Out. thread I. P., ins...	1¼	1½	1½
Each.....	\$0.15	.20	.25
Wgt. per 100, lbs...	7	7½	8½

ROUGH BRASS SLIP JOINT NUTS.

FOR MAKING SLIP JOINT CONNECTIONS WITH IRON PIPE.



1768-C.

Code.....	Promval	Promwiz	Promyez
Size, ins.....	1¼x1¼	1½x1½	1½x1¼
Inside dia., ins.....	1¼	1½	1¼
Inside thread I. P., ins..	1¼	1½	1½
Each.....	\$0.20	.25	.25
Wgt. per 100, lbs...	8¾	17½	17½

† Carried in San Francisco only.

In Orders and Specifications give Plate Numbers and Sizes.

BRASS STRAINERS.

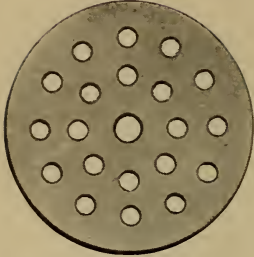

1770-C.
Plain.



1771-C.
Convex.



1772-C.
Fancy.

† **PLAIN FINISHED—1770-C.**

Code.....	Pronacro	Pronador	Pronapide	Pronatabo	Proneness	Pronepos	Pronepotem
Size, inches.....	1¼	1½	2	2½	3	3½	4
Per dozen.....	\$1.20	1.45	1.80	2.40	3.00	4.60	4.80
Weight per dozen, lbs.....	¾	¾	¾	1¾	1¾	2¼	3¼

† **PLAIN NICKEL-PLATED—1770-C.**

Code.....	Pronepti	Proneurs	Pronging	Pronipote	Pronkers	Pronkgraf	Pronkstuk
Size, inches.....	1¼	1½	2	2½	3	3½	4
Per dozen.....	\$1.75	2.25	3.00	4.20	5.00	6.00	8.00
Weight per dozen, lbs.....	¾	¾	¾	1¾	1¾	2¼	3¼

CONVEX FINISHED—1771-C.

Code.....	Pronome	Pronominal	Pronomus	Pronocer
Size, inches.....	2	2½	3	4
Per dozen.....	\$3.00	3.60	4.20	6.00
Weight per dozen, lbs.....	¾	1	1½	3

† **CONVEX NICKEL-PLATED—1771-C.**

Code.....	Pronostico	Prontezza	Prontitul	Pronubabo
Size, inches.....	2	2½	3	4
Per dozen.....	\$5.25	6.25	7.25	9.00
Weight per dozen, lbs.....	¾	1	1½	3

FANCY FINISHED—1772-C.

Code.....	Pronubial	Pronubis	Pronubo	Pronuncio	Pronunzia	Pronurus
Size, inches.....	1½	2	2½	3	3½	4
Per dozen.....	\$1.45	1.80	2.40	3.00	4.60	4.80
Weight per dozen, lbs.....	¾	¾	1¼	1¾	2¼	2¾

† **FANCY NICKEL-PLATED—1772-C.**

Code.....	Proodicos	Proodicum	Proofless	Propagador	Propagarlo	Propagavit
Size, inches.....	1½	2	2½	3	3½	4
Per dozen.....	\$2.25	2.80	4.20	5.00	6.00	7.00
Weight per dozen, lbs.....	¾	¾	1¼	1¾	2¼	2¾

All this page one dozen in a package.

†Carried in San Francisco only.

In Orders and Specifications give Plate Numbers and Sizes.

STAMPED BRASS PLUGS.

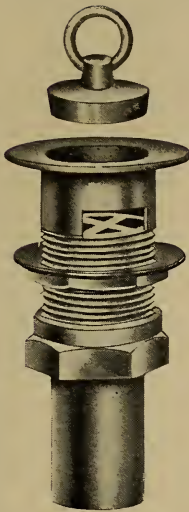

1775-C.

Nickel-Plated Stamped Brass P. O. Basin Plug.
With Rubber Stopper.

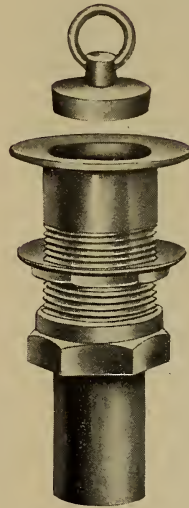

† **1776-C.**

Nickel-Plated Stamped Brass C. O. Basin Plug.
With Rubber Stopper.

Code.....	Propaghi
Per dozen.....	\$10.20
Weight per dozen, lbs.....	5½

Code.....	Propagibus
Per dozen.....	\$10.00
Weight per dozen, lbs.....	5½

One dozen in a box.

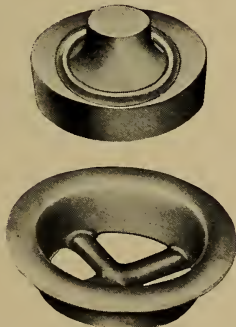

1777-C.

Nickel-Plated Stamped Brass Bath or Sink Plug.

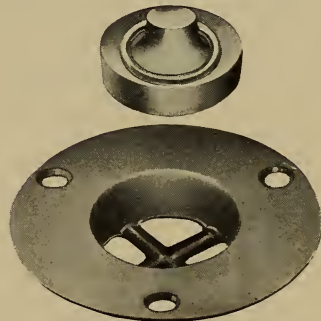

1778-C.

Stamped Brass Wash Tray Plug.

Code.....	Propagions	Propagmen
Size, inches.....	1¼	1½
Per dozen.....	\$2.75	4.00
Weight per dozen, lbs...	1¼	1¾

Code.....	Propagollo
Size, inches.....	† 1½
Per dozen.....	\$5.00
Weight per dozen, lbs.....	2½

One dozen in a box.

† Carried in San Francisco only.

In Orders and Specifications give Plate Numbers and Sizes.

CAST BRASS PLUGS.

WITH BRASS STOPPERS.

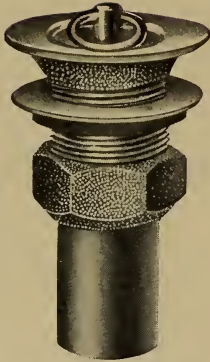

† 1779-C.

Nickel-Plated C. O. Basin Plug.

Code Propalamos
 Size, inch 1
 Per dozen \$8.50
 Weight per dozen, lbs. 7½



1780-C.

Nickel-Plated P. O. Basin Plug.

Code Propalando
 Size, inch 1
 Per dozen \$9.50
 Weight per dozen, lbs. 7½
 One dozen in a box.

BATH OR SINK PLUGS.



1781-C.

WASH TRAY PLUGS.



1782-C.

BATH OR SINK PLUGS—1781-C.

Size, Inches.	Weight Per Dozen, Lbs.	Finished.		Nickel-Plated.	
		Code.	Per Dozen.	Code.	Per Dozen.
1	1¾	Propagule	\$2.50	Propandes	\$3.00
1¼	2¾	Propalar	3.00	Propartida	3.50
1½	3¾	Propalassi	4.00	Propasaran	4.50
†2	7¾	Propalato	7.00	Propatior	8.00

One dozen in a box.

WASH TRAY PLUGS—1782-C.

Size, Inches.	Weight Per Dozen, Lbs.	Finished.		Nickel-Plated.	
		Code.	Per Dozen.	Code.	Per Dozen.
†1	3¾	Propatorem	\$ 3.75	Propediem	\$ 5.00
1¼	4	Propatoris	6.00	Propelled	7.50
1½	Propatrabo	7.00	Propelling	8.75
†2	Propatravi	10.00	Propello	13.00
†2½	Propatulos	17.00	Propellunt	20.00
†3	Propatulum	22.00	Propemodo	25.00

One dozen in a box.

† Carried in San Francisco only.

In Orders and Specifications give Plate Numbers and Sizes.

CAST BRASS PLUGS.

WITH RUBBER STOPPERS.

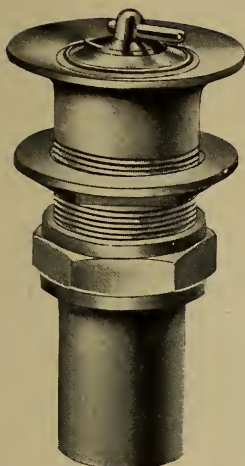

† 1783-C.

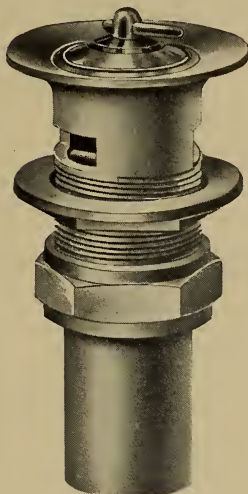

1784-C.

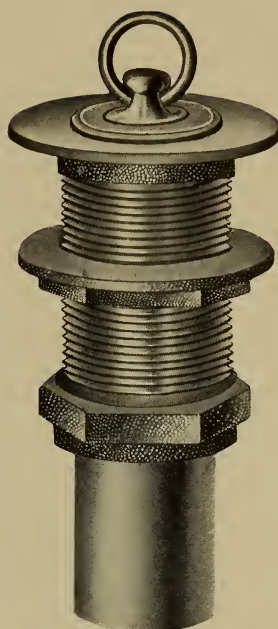

1785-C.

Nickel-Plated C. O. Basin Plug. Nickel-Plated P. O. Basin Plug. † Nickel-Plated Wash Tray Plug.

Code.....	Propendeis	Code.....	Propending	Code.....	Properabat	Properabis
Size, inch.....	1	Size, inch.....	1	Size, inches.....	1¼	1½
Per dozen.....	\$5.50	Per dozen.....	\$6.00	Per dozen.....	\$10.50	15.00
Weight per dozen, lbs..	7¾	Weight per dozen, lbs..	7¾	Dia. of Flange, inches	2½	3
				Weight per dozen, lbs..	18	21

One-half dozen in a box.



1786-C.

Bath or Sink Plug. With Rubber Stopper.

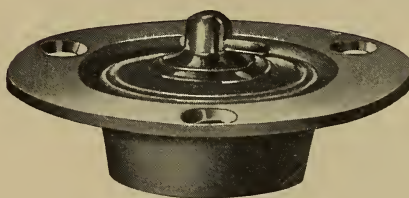

† 1787-C.

Wash Tray Plug. With Rubber Stopper.

BATH OR SINK PLUG—1786-C.

Size, Inches.	Weight Per Dozen, Lbs.	Finished.		Nickel-Plated.	
		Code.	Per Dozen.	Code.	Per Dozen.
† 1	1¾	Properamus.....	\$2.00	Propexi.....	\$2.50
1¼	2¾	Properavit.....	2.25	Propexos.....	2.75
1½	3¼	Properness.....	3.50	Propexum.....	4.00
† 2	6	Propertied.....	5.00	Propgat.....	6.00

† WASH TRAY PLUG—1787-C.

Size, Inches.	Weight Per Dozen, Lbs.	Finished.		Nickel-Plated.	
		Code.	Per Dozen.	Code.	Per Dozen.
1¼	4	Prophani.....	\$3.25	Prophecía.....	\$4.25
1½	5	Prophanos.....	4.00	Prophecias.....	5.00
2	7½	Prophanum.....	6.00	Prophetar.....	7.50

One dozen in a box.

In Orders and Specifications give Plate Numbers and Sizes.

RUBBER STOPPERS.

WITH NICKEL-PLATED RINGS.



1790-C.

Code.....	Propiabo	Propiamus	Propice	Propiciar	Propiedad	Propilabis	Propilavit
Size, inches.....	3/4	7/8	1	1 1/8	1 1/4	1 1/2	2
Per dozen.....	\$1.20	1.20	1.20	1.25	1.50	2.00	3.00
Weight per dozen, lbs.....	3/8	1/2	5/8	3/4	7/8	1	1 3/8

GOOD RUBBER STOPPERS.



1791-C.

BASIN.



1792-C.

BATH.

Code.....	Propina
Outside diameter, inches.....	2
Per dozen.....	\$4.00
Weight per dozen, lbs.....	1 1/4

Code.....	Propinaran
Outside diameter, inches.....	2 5/8
Per dozen.....	\$6.00
Weight per dozen, lbs.....	1 1/4

BRASS BASIN CRATE.

NICKEL-PLATED WITH 2-INCH DETACHABLE STRAINERS, COUPLING 1 INCH.



1793-C.

Code.....	Propincos
Size, inch.....	1
Per dozen.....	\$21.00



1794-C.

1794-C.—Threaded for 3/4 inch Iron Pipe.

Code.....	Propining
Size, coupling inch...	1
Per dozen.....	\$9.00

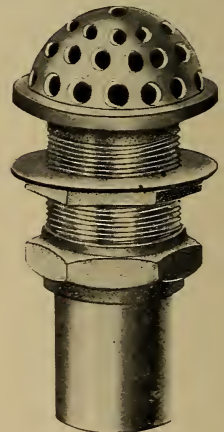

1795-C.

1755-C.—Coupling, 1 inch.

Code.....	Propionate
Size, coupling inch.....	1
Per dozen.....	\$15.00

In Orders and Specifications give Plate Numbers and Sizes.

SINK GRATE.

RAISED BRASS STRAINER.

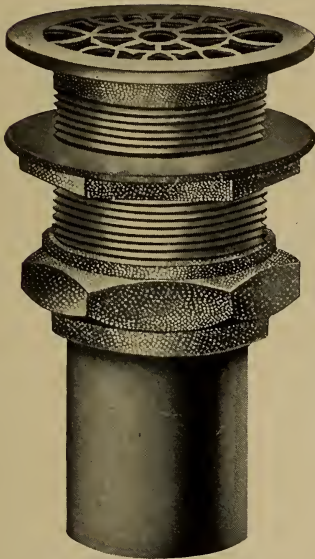

†1800-C.

NICKEL-PLATED WITH DETACHABLE STRAINER.

Code	Propitious
Diameter of flange, inches.....	3 ⁵ / ₁₆
Size of coupling, inches.....	1 ³ / ₄
Per dozen.....	\$51.00
Weight per dozen, lbs.....	24

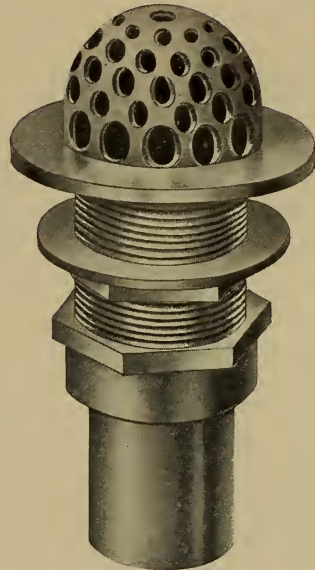

†1801-C.

NICKEL-PLATED FOR URINAL TROUGH.

Code.....	Propiasm
Diameter of flange, inches.....	4
Size of coupling, inches.....	1 ¹ / ₂
Per dozen.....	\$54.50
Weight per dozen, lbs.....

RAISED BRASS STRAINERS.



†1802-C.

†RAISED BRASS STRAINER WITH FLANGE—1802-C.

Code.....	Finished.		Nickel-Plated.	
	Proplastic	Propodium	Propolarum	Propoleos
Size, inches.....	2	3	2	3
Per dozen.....	\$8.00	12.00	10.00	15.00
Weight per dozen, lbs.....

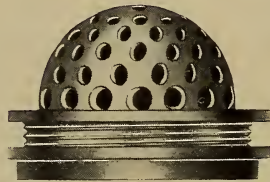

†1803-C.

†RAISED BRASS STRAINER WITH TRAP SCREW—1803-C.

Code.....	Finished.		Nickel-Plated.	
	Propolibus	Propoliser	Propomata	Propondria
Size, inches.....	2	3	2	3
Per dozen.....	\$15.00	30.00	17.00	34.00
Weight per dozen, lbs.....

†Carried in San Francisco only.

In Orders and Specifications give Plate Numbers and Sizes.

BELL TRAP FLOOR DRAIN.

BRASS WITH IRON FORKED LOCK NUT.

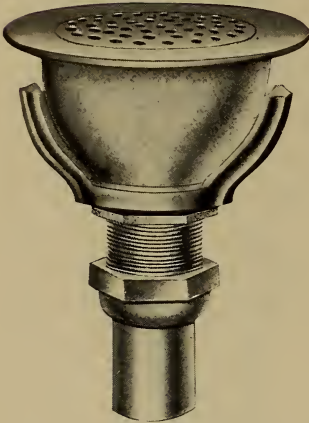

†1804-C.

Diameter of flange 4 inches.
Coupling 1½-inch.

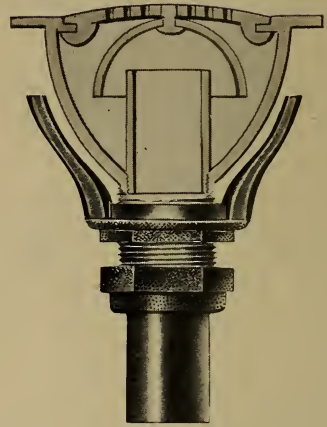

1804-C.

Sectional View.

Code
Each
Weight each, lbs.....

	Rough Brass with Finished Flange and Strainer.	Rough Brass with Nickel-Plated Flange and Strainer.
	Proponessi	Proponeva
	\$2.80	3.20
	3	3

DRIP CUP FOR MARBLE DRINKING FOUNTAIN.

NICKEL-PLATED.

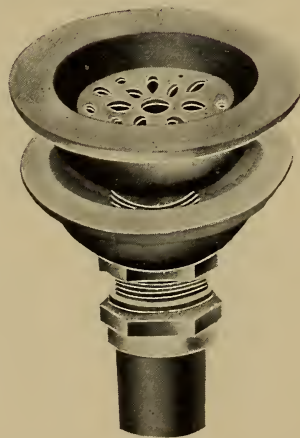

†1805-C.

Diameter of Flange, 5 inches.
Coupling, 1¼ inches.

Code	Propongas
Per dozen.....	\$58.00
Weight per dozen, lbs.....	36

†Carried in San Francisco only.

In Orders and Specifications give Plate Numbers and Sizes.

CHAIN STAYS.

BRASS. NICKEL-PLATED.



1815-C.

No. 0—For Wood.



1816-C.

No. 1



1817-C.

No. 2



1818-C.

No. 3—For Cock Hole.

Code.....	Proponentica	Proponent	Proposable	Proposit
Number.....	10	1	2	3
Per dozen.....	\$2.50	2.50	3.75	4.25
Weight per dozen, lbs.....	½	¾	1½	2

One dozen in a box.



1819-C.

No. 4



†1820-C.

No. 5



†1821-C.

No. 6



1822-C.

No. 11

Code.....	Proposames	Proposcras	Proposito	Propound
Number.....	4	5	6	11
Per dozen.....	\$6.50	8.00	9.00	5.25
Weight per dozen, lbs.....	5	2½	4½	3¼

One dozen in a box.

† Carried in San Francisco only.

In Orders and Specifications give Plate Numbers and Stock Numbers.

CHAIN STAYS.

NICKEL-PLATED.

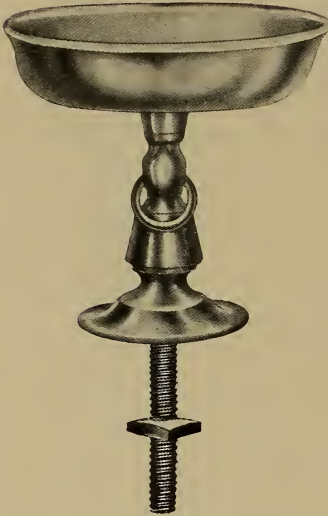

1825-C.

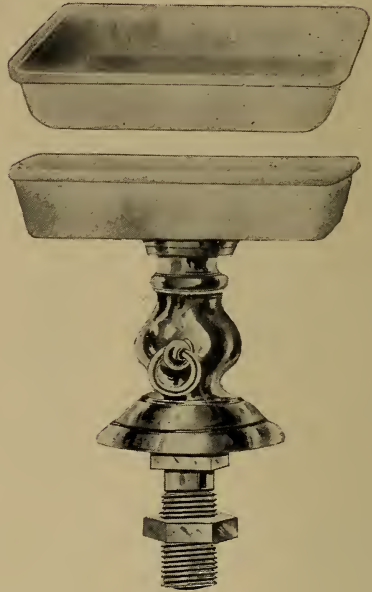

1826-C.

**FOR COCK HOLE WITH GOLD-LINED
REMOVABLE TRAY.**

Code.....	Proppage
Number.....	18
Size tray, inches.....	4¼ x 2⅞
Each.....	\$5.00
Weight each, lbs.....	1

Code.....	Proppretor
Number.....	19
Size tray, inches.....	4½ x 2⅞
Each.....	\$6.00
Weight each, lbs.....	1¼

One-half dozen in a box.

COCK HOLE COVERS.



1830-C.

FOR BASIN COCK HOLE.

Code.....	Propriatos
Outside diameter, inches.....	1½
Per dozen.....	\$4.50
Weight per dozen, lbs.....	⅞

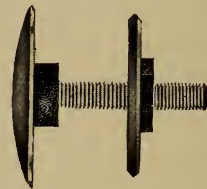

1831-C.

FOR BATH COCK HOLE.

Code.....	Proppretor
Outside diameter, inches.....	1¾
Per dozen.....	\$4.80
Weight per dozen, lbs.....	2¼

One dozen in a package.

In Orders and Specifications give Plate Numbers.

SINGLE JACK CHAIN.

CUT SHOWS EXACT SIZES.

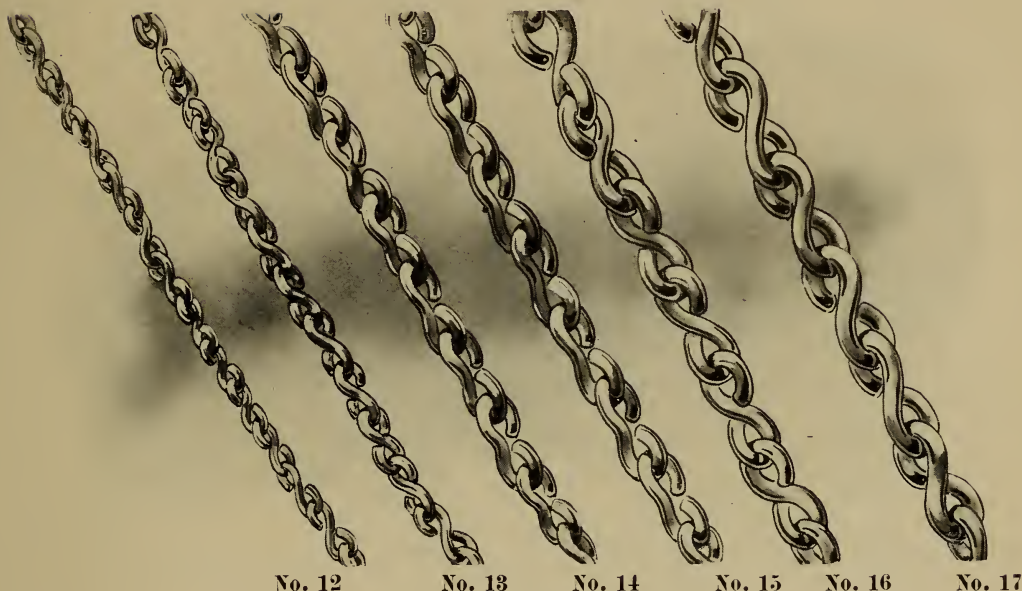

1835-C.

IRON JACK CHAIN.

Code.....	Propteres	Proptervia	Proptoma
Number	9	10	12
Per dozen yards.....	\$0.90	.80	.44
Weight per package, lbs.....	4¾	3¾	2¾

One dozen yards in a package.

BRASS JACK CHAIN.

Code.....	Propudia	Propuesto	Propagnar	Propugno	Propulsaba	Propulse
Number	8	10	12	13	14	15
Per dozen yards.....	\$5.25	3.50	2.05	1.70	1.35	1.00
Weight per package, lbs.....	6¾	4	2½	2	1¾	1¼

Code	Propulsif	Propunges	Proposiste	Propusol	Prosador
Number	16	17	18	20	22
Per dozen yards.....	\$0.86	.82	.60	.50	.40
Weight per package, lbs.....	1	¾	¾	¾	¾

One dozen yards in a package.

NICKEL-PLATED JACK CHAINS.

Code	Prosailer	Prosaïque	Prosaismo	Prosaist	Prosalium	Prosanmo
Number	12	13	14	15	16	17
Per dozen yards.....	\$2.56	2.12	1.69	1.25	1.07	1.07
Weight per package, lbs.....	2½	2	1¾	1¼	1	¾

One dozen yards in a package.

In Orders and Specifications give Plate Numbers and Stock Numbers.

BRASS SAFETY CHAIN.

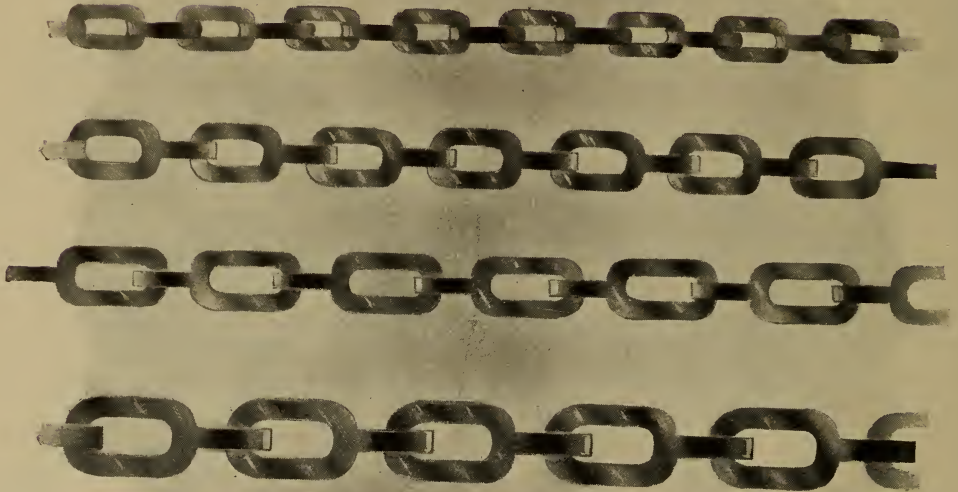

1836-C.

BRASS SAFETY CHAIN.

Code	Prosapia	Prosarios	Prosarono	Prosaite
Number	00	0	1	†2
Per dozen yards.....	\$1.25	1.50	1.85	2.30
Weight per dozen yards, lbs.....	5/8	3/4	1 1/8	1 3/4

One dozen yards in a package.

NICKEL-PLATED SAFETY CHAIN.

Code.....	Prosastica	Prosaieur	Prosavamo	Proscenium
Number.....	00	0	1	†2
Per dozen yards.....	\$1.35	1.60	1.95	2.40
Weight per dozen yards, lbs.....	5/8	3/4	1 1/8	1 3/4

One dozen yards in a package.

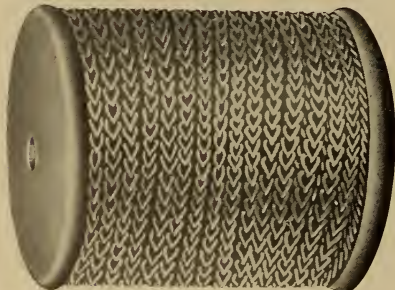

NICKEL-PLATED SAFETY CHAIN ON REELS.

Code	Proscholi	Proscholos	Proscindes	Proscoll
Number.....	†00	0	1	†2
Per 100 feet	\$3.80	4.50	5.40	6.60
Wt. per reel, lbs...	10 1/2	13	15 1/2	24

500 feet on a reel.

† Carried in San Francisco only.

1837-C.

In Orders and Specifications give Plate Numbers and Sizes.

BASIN AND BATH CHAINS AND SNAPS.

BRASS.



1840-C.

No. 00—Basin Chains.

No. 1—Bath Chains.

Code.....	Proscopia
Style.....	Nickel-Plated
Length, inches.....	16
Per dozen.....	\$1.15
Weight per dozen, lbs.....	3/8

Code.....	Proscopide	Proscriba
Style.....	Brass	† Nickel-Plated
Length, inches.....	16	16
Per dozen.....	\$1.60	1.75
Weight per dozen, lbs...	3/8	3/8

One dozen in a package.

WASH TRAY CHAINS AND SNAPS.

No. 12 BRASS, 20 INCHES LONG.

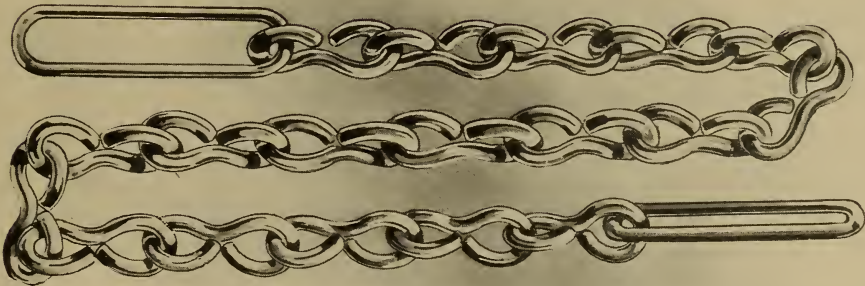

1841-C.

Code.....	Proscipsi	Proscocas
Style.....	Brass	Nickel-Plated
Per dozen.....	\$1.20	1.45
Weight per dozen, lbs.....	1 1/2	1 1/2

One dozen in a package.

SNAPS OR SPLIT LINKS FOR CHAIN.

BRASS. NICKEL-PLATED.

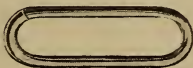

1842-C.
Cut shows exact size.
Small.

Code.....	Prosecamus
Per gross.....	\$1.80

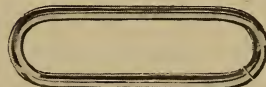

1843-C.
Cut shows exact size.
Large.

Code.....	Prosecanda
Per gross.....	\$2.40

One gross in a package.

† Carried in San Francisco only.

In Orders and Specifications give Plate Numbers.

FLANGES OR ESCUTCHEONS.

SPUN BRASS.



1850-C.
Bibb Flanges.



1851-C.
Deep Flanges for Iron Pipe.

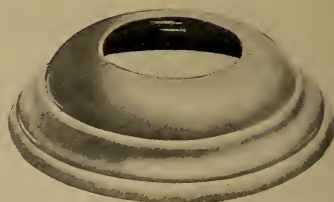

1852-C.
Deep Flanges for Tubing.

BIBB FLANGES—1850-C.

Brass.

Code.....	Prosecute	Proседа	Prosedamo
Size, inches.....	$\frac{1}{2}$	$\frac{3}{4}$	1
Diameter of hole, in...	$\frac{7}{8}$	$1\frac{1}{8}$	$1\frac{3}{8}$
Outside diameter, in..	3	3	3
Per dozen.....	\$0.75	.75	.85
Weight per gross, lbs..	$2\frac{7}{8}$	3	$3\frac{1}{4}$

Nickel-Plated.

Code.....	Prosedenti	Proseggia	Proseguir
Size, inches.....	$\frac{1}{2}$	$\frac{3}{4}$	1
Diameter of hole, in..	$\frac{7}{8}$	$1\frac{1}{8}$	$1\frac{3}{8}$
Outside diameter, in..	3	3	3
Per dozen.....	\$1.00	1.00	1.10
Weight per gross, lbs	$2\frac{7}{8}$	3	$3\frac{1}{4}$

One gross in a package.

DEEP FLANGES FOR IRON PIPE—1851-C.

Nickel-Plated.

Code.....	Proseleni	Proselytes	Proselyto	Proseminas	Prosenes	Prosequere
Size, inches.....	$\dagger\frac{3}{8}\times 2\frac{1}{8}$	$\frac{3}{8}\times 2\frac{1}{2}$	$\frac{1}{2}\times 2\frac{1}{8}$	$\frac{3}{4}\times 2\frac{1}{2}$	1x3	$\dagger 1\frac{1}{4}\times 3$
Diameter of hole, inches.....	$\frac{2\frac{1}{32}}$	$\frac{2\frac{1}{32}}$	$\frac{2\frac{1}{32}}$	$1\frac{1}{16}$	$1\frac{5}{16}$	$1\frac{5}{8}$
Diameter of base, inches.....	$2\frac{1}{8}$	$2\frac{1}{8}$	$2\frac{1}{8}$	$2\frac{1}{2}$	3	3
Depth, inches.....	$\frac{5}{8}$	$\frac{5}{8}$	$\frac{5}{8}$	$\frac{3}{4}$	1	1
Per dozen.....	\$0.50	.50	.50	.75	.75	.75
Weight per gross, lbs.....	$1\frac{1}{2}$	$2\frac{5}{8}$	$2\frac{1}{2}$	$2\frac{7}{8}$	$2\frac{1}{2}$	$5\frac{1}{4}$

One gross in a package.

DEEP FLANGES FOR TUBING—1852-C.

Nickel-Plated.

Code.....	Prosequor	Proseranno	Proseribat
Size, inches.....	1$\frac{1}{4}$	1$\frac{1}{2}$	$\dagger 2$
Diameter of hole, inches.....	$1\frac{1}{4}$	$1\frac{1}{2}$	2
Diameter of base, inches.....	3	3	$3\frac{3}{4}$
Depth, inches.....	1	1	$1\frac{1}{2}$
Per dozen.....	\$0.75	.75	1.20
Weight per gross, lbs.....	$5\frac{3}{8}$	$5\frac{1}{2}$	6

One gross in a package.

†Carried in San Francisco only.

In Orders and Specifications give Plate Numbers and Sizes.

BASIN CLAMPS.

SUPERIOR.

STAR.

No. 3.

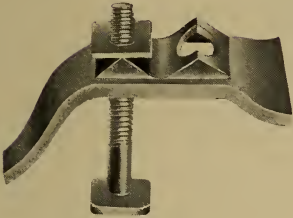

1855-C.

Polished Sheet Brass.

Adjusts itself to any basin and is guaranteed not to slip, break or bend.

Code.....	Prosertos
Per dozen	\$1.00
Weight per dozen, lbs..	¾
Three dozen in a box.	

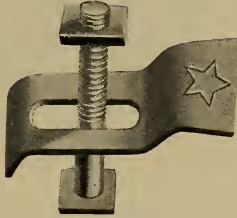

1856-C.

Heavy Finished Brass.

The Star will do the work of most adjustable clamps.

Code.....	Proserunt
Per dozen.....	\$0.50
Weight per dozen, lbs..	⅝
Twelve dozen in a box.	

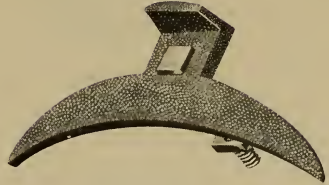

† 1857-C.

Cast Brass.

Code.....	Prosettore
Per dozen.....	\$1.00
Weight per dozen, lbs..	1¼
Loose.	

SLIP JOINT LAVATORY SUPPLY PIPE ELBOWS.

POLISHED BRASS NICKEL-PLATED.

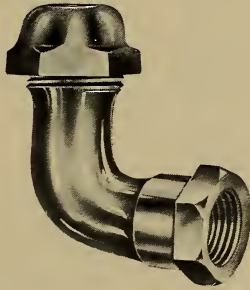

† 1860-C.

These Slip Joints are furnished with Rubber Washers and Brass Chafing Ring.

Code.....	Prosevero	Prosiate
Size, inches.....	¾-in. I. P.x ½-in. Tube	½-in. I. P.x ½-in. Tube
Each.....	\$0.55	.60
Weight each, lbs.....	⅜	¾

For Straight Slip Joints, see page 204.

† Carried in San Francisco only.

In Orders and Specifications give Plate Numbers and Sizes.

NAUGATUCK SEAMLESS COPPER BALLS.



1865-C.
Without Stem.

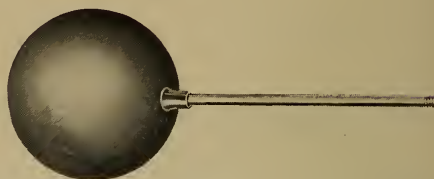

1866-C.
With Stem.

NAUGATUCK COPPER BALLS WITHOUT STEM—1865-C.

Code.....	Prosigias	Prosigue	Prosisto	Prosocrus	Prosodical	Prosodist	Prosoma	Prosopide
Size, inches.....	3	4	5	6	7	8	10	12
Per dozen.....	\$5.25	6.25	7.25	8.25	17.00	27.00	47.00	60.00
Weight per dozen, lbs.....	2½	5	8	9	15	22	38	40

3, 4, 5, 6, 7 and 8-inch Naugatuck Balls have socket threaded $\frac{1}{32}$ inch, 24 threads to the inch.
10 and 12-inch Naugatuck Balls have socket threaded for $\frac{1}{8}$ -inch Iron Pipe.

NAUGATUCK COPPER BALLS WITH STEM—1866-C.

Code.....	Prosopeon	Prospectif	Prospecto	Prosperado
Size, inches.....	4	6	7	8
Per dozen.....	\$7.25	10.25	18.50	30.00
Weight per dozen, lbs.....	7¼	10¼	19	26

Stems for Naugatuck Balls are 8 inches long, both ends threaded $\frac{1}{32}$ inch, 24 threads to the inch.

CORRUGATED COPPER BALLS.



1867-C.

SPUN COPPER BALLS.



1868-C.

Code.....	Prospicuos	Prostabunt	Code.....	Prostadem	Prostadis	Prostasi
Size, inches.....	5	6	Size, inches.....	7	8	10
Per dozen.....	\$5.50	6.25	Per dozen.....	\$9.75	14.00	22.50
Weight per dozen, lbs.....	3	5½	Wt. per doz., lbs.....	9	13	21

5, 6 and 7-inch Balls have Sockets threaded $\frac{1}{36}$ inch, 20 threads to the inch.
8-inch Balls have Sockets threaded $\frac{1}{4}$ inch, 20 threads to the inch.
10-inch Balls have Sockets threaded $\frac{5}{16}$ inch, 20 threads to the inch.

In Orders and Specifications give Plate Numbers and Sizes.

SPUN ZINC BALLS.

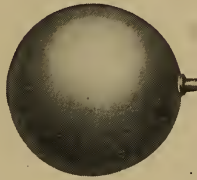

1869-C.

Sockets Threaded, $\frac{7}{32}$ inch; 20 Threads to the Inch.

Code.....	Prostata	Prostemion
Size, inches.....	5	6
Per dozen.....	\$4.50	5.25
Weight per dozen, lbs.....	9	10½

**BRASS STEMS OR RODS FOR CORRUGATED
COPPER, SPUN COPPER AND
ZINC BALLS.**

THESE STEMS HAVE 20 THREADS TO THE INCH.



1870-C.

Code.....	Prosterno	Prosthesis	Prostheto
Length, inches.....	11	13	14
Size rod, inches.....	$\frac{1}{4}$	$\frac{5}{16}$	$\frac{3}{8}$
Thread, inch.....	$\frac{7}{32}$	$\frac{1}{4}$	$\frac{5}{16}$
For balls, inches.....	3, 4, 5, 6, 7	8	10
Per dozen.....	\$1.80	4.50	4.50
Weight per dozen, lbs.....	2¼	4	6

GLASS BALLS OR FLOATS.

WITH STEMS OR RODS.



†1871-C.

Stems Threaded, $\frac{7}{32}$ inch; 24 Threads to the Inch.

Code.....	Prostlaub	Prostluggi
Size, inches.....	5	6
Per dozen.....	\$8.00	9.00
Weight per dozen, lbs.....	15	17

†Carried in San Francisco only.

In Orders and Specifications give Plate Numbers and Sizes.

L BURNER GAS COCKS.

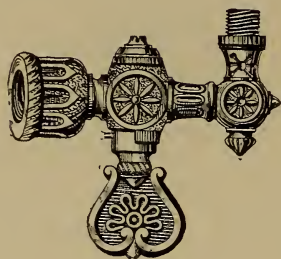

† 1880-C.

Code.....	Prostrada	Prostrador	Prostyle	Prostylus
Size, inch.....	1/2	3/8	1/4	1/8
Per dozen.....	\$6.20	5.20	4.55	4.25

INDEPENDENT COCKS.

FOR RUBBER HOSE.

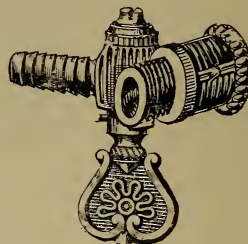

1881-C.

Code.....	Prosubigo	Prosumni	Prosummus	Prosupant
Size, inch...	1/2	3/8	1/4	1/8
Per dozen...	\$8.00	6.50	6.00	5.50

HOSE GAS COCKS.

FEMALE.

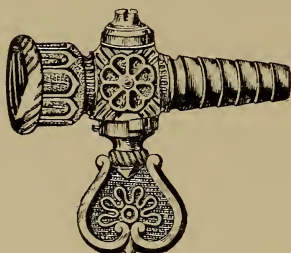

1882-C.

Code.....	Prosupes	Prosuppas	Prosymna	Protadius
Size, inch....	1/2	3/8	1/4	1/8
Per dozen...	\$5.25	4.90	4.55	4.25

GAS STOP COCKS.

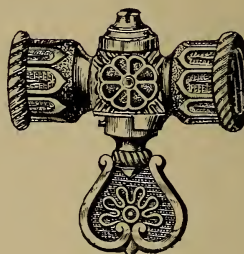

†1883-C.

Code.....	Protagia	Protagon	Protandry	Protaster
Size, inch....	1/2 x 1/2	3/8 x 3/8	1/4 x 1/4	1/8 x 1/8
Per dozen...	\$5.60	4.90	4.55	3.90

TWO-LIGHT BRACKET BODIES.

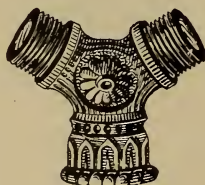

†1884-C.

Code.....	Protaulam
Size, inch.....	3/8
Per dozen.....	\$3.90

† Carried in San Francisco only.

BRASS PILLARS.



†1885-C.

Code.....	Protean
Per dozen.....	\$0.20

In Orders and Specifications give Plate Numbers and Sizes.

STIFF GAS BRACKETS.

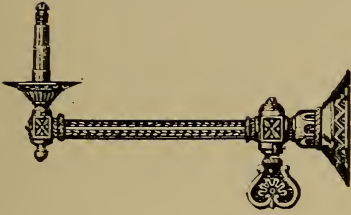

†1890-C.

STRAIGHT 3/8-INCH FIGURED GILT TUBE.

Code	Proteger
Length, inches.....	6
Each.....	\$0.40

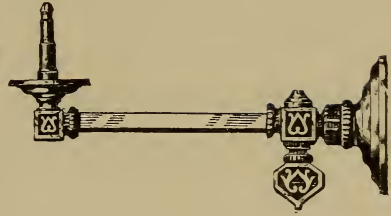

†1891-C.

STRAIGHT SQUARE POLISHED BRASS TUBE.

Code	Protego
Length, inches.....	7
Each.....	\$0.65



†1892-C.

STRAIGHT SQUARE TWIST POLISHED BRASS.

Code	Protegerido
Each.....	\$0.70



†1893-C.

CURVE 3/8-INCH FIGURED GILT TUBE.

Code	Proteginus
Each.....	\$0.45

SINGLE SWING GAS BRACKETS.

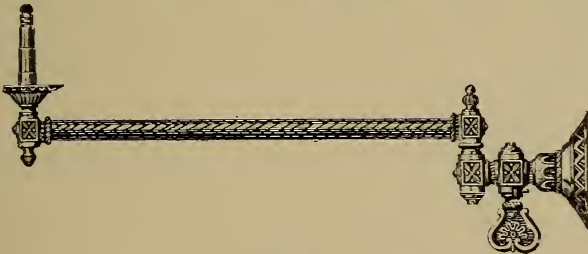

†1894-C.

1894-C.

1 SWING 3/8-INCH FIGURED GILT TUBE.

Code	Proteginus
Each.....	\$0.50

1895-C.

1 SWING SQUARE POLISHED BRASS TUBE.

Code	Protelabis
Each.....	\$0.90

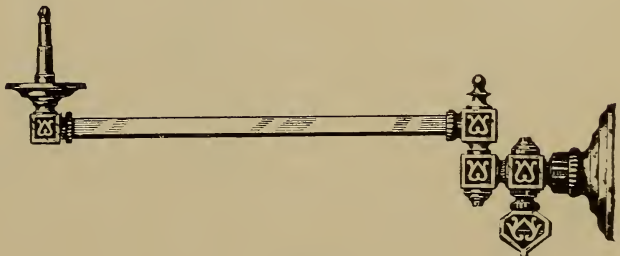

†1895-C.

†Carried in San Francisco only.

In Orders and Specifications give Plate Numbers.

DOUBLE SWING GAS BRACKETS.

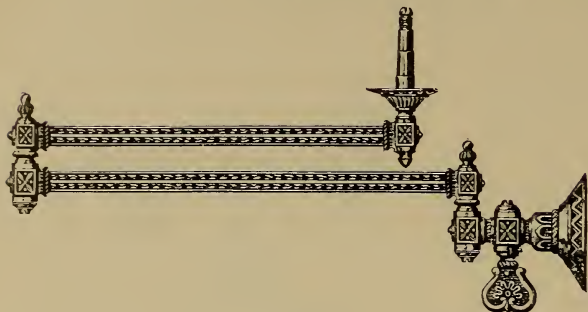

† 1896-C.

1896-C.

2-swing 3/8-inch Figured Gilt Tube.

Code..... Protelavit
 Each..... \$0.80

1897-C.

2-swing Square Polished Brass Tube.

Code..... Protello
 Each..... \$1.35

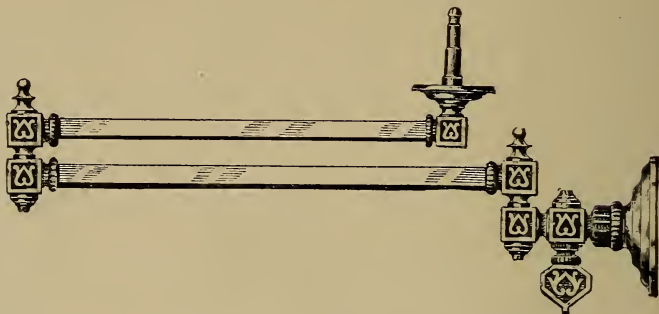

†1897-C.

TRIPLE SWING GAS BRACKETS.

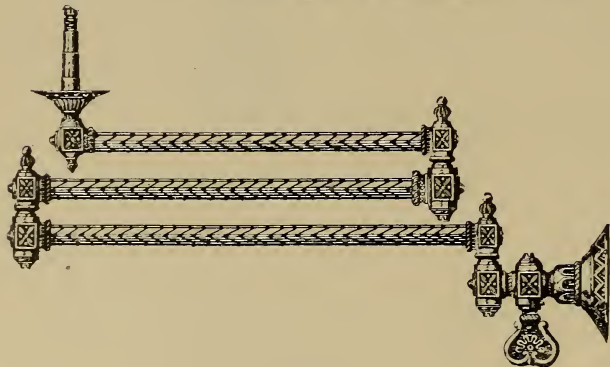

†1898-C.

1898-C.

3-swing 3/8-inch Figured Gilt Tube.

Code..... Protelorum
 Each..... \$1.15

1899-C

3-swing Square Polished Brass Tube.

Code..... Protendero
 Each..... \$1.85

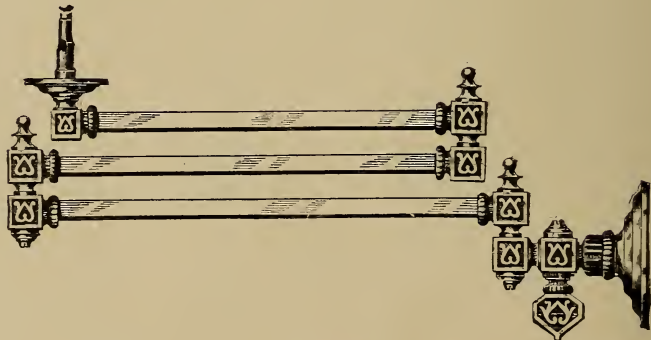

†1899-C.

†Carried in San Francisco only.

In Orders and Specifications give Plate Numbers.

GAS PENDANTS.

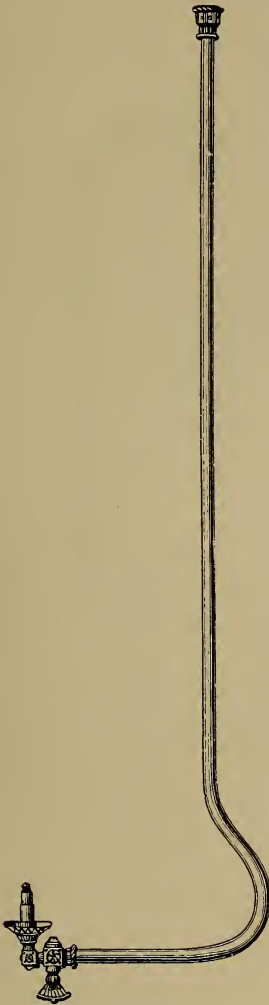

1902-C.

CURVED 3/8-INCH GILT TUBE WITH COCK.
LENGTH, 30 INCHES.

Code..... Protendes
Each..... \$0.75



1903-C.

CURVED 1/8-INCH IRON PIPE FRENCH BRONZED
WITH COCK. LENGTH, 30 INCHES.

Code..... Protenomes
Each..... \$0.68

LAVA GAS TIPS.



Code.....	Proteo	Protuvia	Protestar	Protestdag
Capacity, feet.....	3	4	5	6
Per gross.....	\$1.75	1.75	1.75	1.75

One gross in a box.

1904-C.

ALUMINUM GAS TIPS.

Code.....	Protheite	Prothoos	Prothorax	Prothyme	Prothymia
Capacity feet.....	2	3	4	5	6
Per gross.....	\$3.50	3.50	3.50	3.50	3.50

One gross in a box.



1905-C.

In Orders and Specifications give Plate Numbers.

STORK NECKS.



†1908-C.

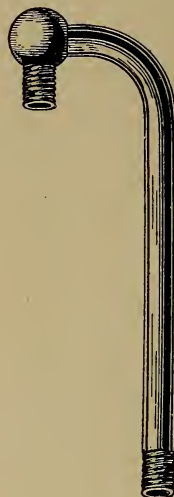

†1909-C.

Polished Brass Combination Stork Neck. Connects with Pillar Burner by removing gas tip. Can be used with rubber-tipped gas tubing or with threaded connections.

Code	Protinam
Number	82
Per dozen	\$3.00

Polished Brass Stork Neck for use with threaded connections only.

Code	Protinus
Number	990
Per dozen	\$3.60

BOX PLATES.

Polished Brass.

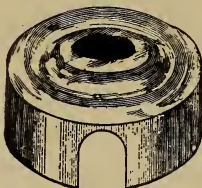

†1910-C.

Diameter, 2½ inch for ¾-inch Iron Pipe.

Code	Protista
Per dozen	\$1.00
Weight per dozen, lbs

†Carried in San Francisco only.

In Orders and Specifications give Plate Numbers.

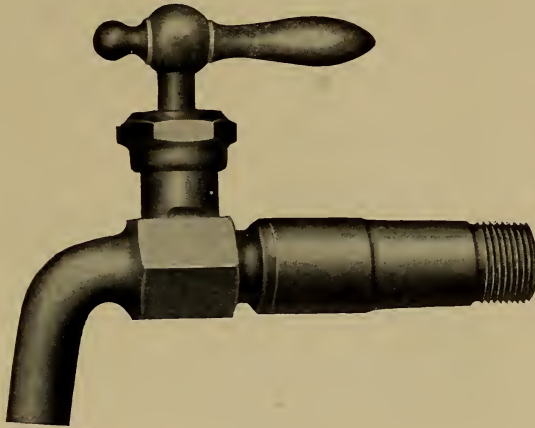
FULLER PLAIN BIBBS.**1925-C.****SCREW ON TAIL FOR IRON PIPE.**

Size, Inches.	Weight Per Dozen, Lbs.	Finished.		Nickel-Plated.	
		Code.	Per Dozen.	Code.	Per Dozen.
	12½	Protocolo	\$23.00	Protokoll	\$27.00
† 5/8 x 1/2	12½	Protofillo	27.00	Protollis	31.00
5/8 x 3/4	13	Protogala	27.00	Protollunt	31.00
	17	Protogenis	34.00	Protologia	40.00
†1	27½	Protogyny	54.00	Protomante	64.00

One-half dozen in a box.

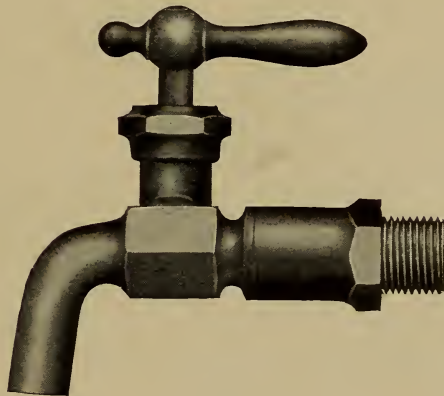
**†1926-C.****WITH SHOULDER FOR IRON PIPE.**

Size, Inches.	Weight Per Dozen, Lbs.	Finished.		Nickel-Plated.	
		Code.	Per Dozen.	Code.	Per Dozen.
1/2	12	Protonabis	\$21.00	Protopine	\$25.00
5/8 x 1/2	12½	Protonie	24.00	Protoplasm	28.00
5/8 x 3/4	13	Protopapa	24.00	Protopope	28.00

One-half dozen in a box.

† Carried in San Francisco only.

In Orders and Specifications give Plate Numbers and Sizes.

FULLER HOSE BIBBS.

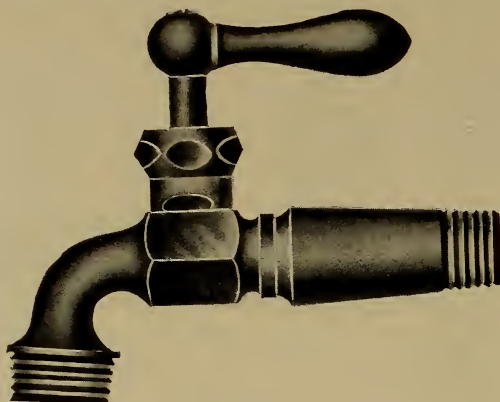

1927-C.

SCREW ON TAIL FOR IRON PIPE.

Size, Inches.	Weight Per Dozen, Lbs.	Finished.		Nickel-Plated.	
		Code.	Per Dozen.	Code.	Per Dozen.
1/2	13	Protosalt	\$26.00	Protozoon	\$30.00
† 5/8 x 1/2	14	Protoslave.....	31.00	Protract	35.00
5/8 x 3/4	14	Protospore	31.00	Protraggo	35.00
3/4	17 1/2	Protossido	38.00	Protrahir	44.00
† 1	25	Prototipia	58.00	Protritos.....	68.00

One-half dozen in a box.

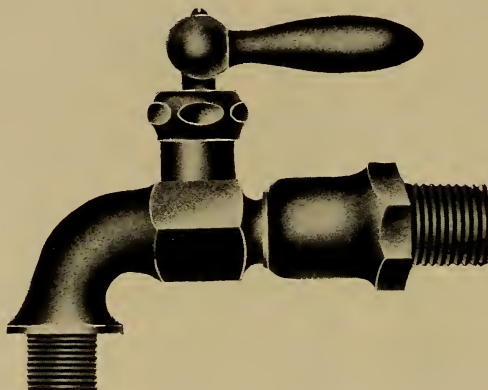

† 1928-C.

WITH SHOULDER FOR IRON PIPE.

Size, Inches.	Weight Per Dozen, Lbs.	Finished.		Nickel-Plated.	
		Code.	Per Dozen.	Code.	Per Dozen.
1/2	12 1/2	Protropa	\$24.00	Protrude.....	\$28.00
5/8 x 1/2	12 1/2	Protropis	28.00	Protrudunt	32.00
5/8 x 3/4	13 1/2	Protropum	28.00	Protrusile.....	32.00

One-half dozen in a box.

† Carried in San Francisco only.

In Orders and Specifications give Plate Numbers and Sizes.

“MONARCH” FULLER BIBBS.

BEST QUALITY RED METAL. EXTRA HEAVY PATTERN. HIGHLY POLISHED AND FINISHED
NON-HAMMERING AND ANTI-RATTLING. ARTISTIC DESIGN.
TESTED AND GUARANTEED.

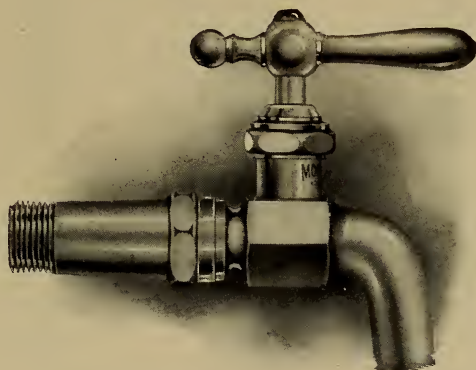

1930-C.

“MONARCH” FULLER PLAIN BIBBS. SCREW ON TAIL FOR IRON PIPE.

Size, Inches.	Weight Per Dozen, Lbs.	Finished.		Nickel-Plated.	
		Code.	Per Dozen.	Code.	Per Dozen.
$\frac{1}{2}$	12	Protrygea	\$23.00	Protumidos	\$27.00
$\frac{5}{8} \times \frac{1}{2}$	$12\frac{3}{4}$	Prottosi	27.00	Proturbes	31.00
$\frac{3}{8} \times \frac{3}{4}$	$14\frac{1}{2}$	Protules	27.00	Protutela	31.00

One-half dozen in a box.

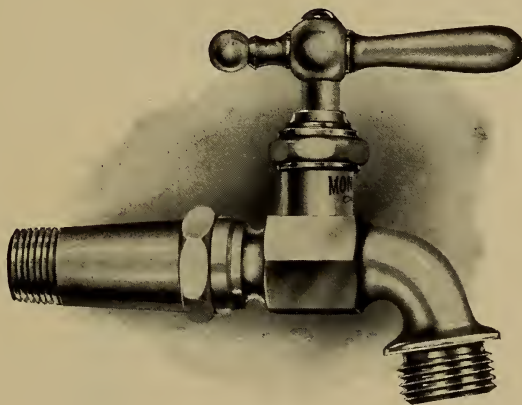

1931-C.

“MONARCH” FULLER HOSE BIBBS. SCREW ON TAIL FOR IRON PIPE.

Size, Inches.	Weight Per Dozen, Lbs.	Finished.		Nickel-Plated.	
		Code	Per Dozen.	Code.	Per Dozen.
$\frac{1}{2}$	$12\frac{3}{4}$	Protzig	\$26.00	Protzrad	\$30.00
$\frac{5}{8} \times \frac{1}{2}$	$13\frac{1}{2}$	Protzkette	31.00	Protzring	35.00
$\frac{5}{8} \times \frac{3}{4}$	$15\frac{1}{4}$	Protznagel	31.00	Protzwagen	35.00

One-half dozen in a box.

In Orders and Specifications give Plate Numbers and Sizes.

TRIMMINGS FOR FULLER WORK.

FANCY HANDLES.

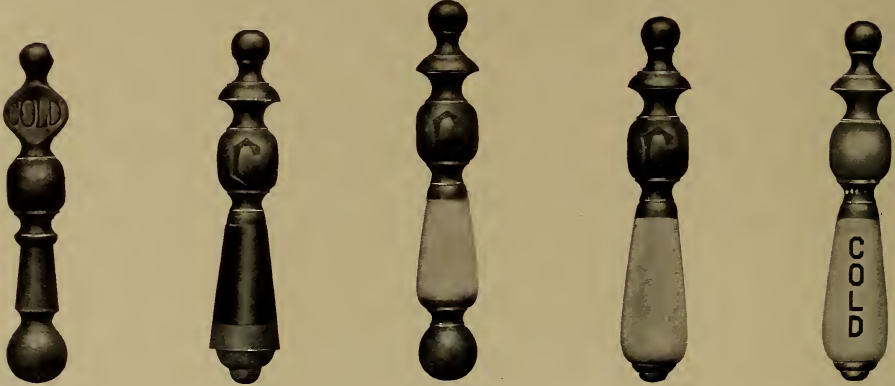

†1950-C. Brass, Marked Hot and Cold.	†1951-C. Ebony or Ivory.	†1952-C. Short China.	†1953-C. Long China.	†1954-C. China, Marked Hot and Cold.
Code	Code	Code	Code	Code
Plate number	Plate number	Plate number	Plate number	Plate number
Add to price of Cocks, per dozen.....	Add to price of Cocks, per dozen.....	Add to price of Cocks, per dozen.....	Add to price of Cocks, per dozen.....	Add to price of Cocks, per dozen.....
	\$2.00	12.00	15.00	15.00
				15.00

If wanted separately, without Cocks, add \$4.00 per dozen to above prices.

ECCENTRICS. STEMS AND BALLS. RUBBER BALLS.



1955-C.



1956-C.



1957-C.

† ECCENTRICS—1955-C.

Code	Provacao	Provadura	Provanca	Provarle
Size, inches.....	1/2	3/8	3/4	1
Per dozen	\$3.00	3.00	4.00	6.00

† STEMS AND BALLS—1956-C.

Code.....	Provativo	Provatore	Provavel	Provechas
Size, inches.....	1/2	3/8	3/4	1
Per dozen.....	\$3.00	3.00	4.00	6.00

RUBBER BALLS—1957-C.

Code.....	Provecta	Proveditor	Provedoria	Provenance	Provençal
Size, inches.....	1/2	3/8	3/4	1	1 1/4
Per dozen.....	\$0.75	.75	1.00	1.25	2.00
Weight per gross, lbs.....	1 1/2	2	3 3/4	6

† RUBBER BALLS (FOR HOT WATER).

Code	Provender	Provenida	Provento
Size, inches.....	1/2	3/8	3/4
Per dozen	\$0.75	.75	1.00
Weight per gross, lbs.....	1 1/2	2	3 3/4

†Carried in San Francisco only.

In Orders and Specifications give Plate Numbers and Sizes.

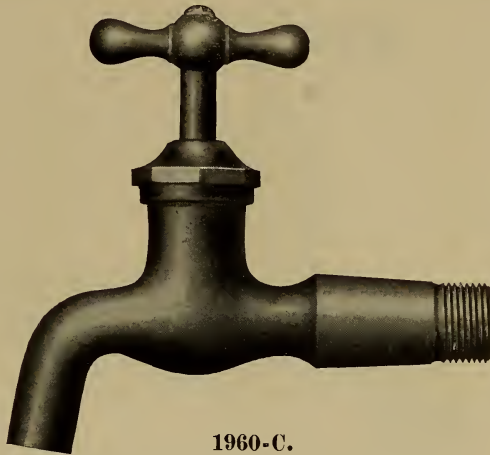
COMPRESSION PLAIN BIBBS.**1960-C.****SCREW ON TAIL FOR IRON PIPE.**

Size, Inches.	Weight Per Dozen, Lbs.	Rough.		Finished.		Nickel-Plated.	
		Code.	Per Dozen.	Code.	Per Dozen.	Code.	Per Dozen.
$\frac{1}{2}$	11	Proxying	\$14.50	Prudishly	\$ 15.00	Pruegeln	\$17.50
$\frac{3}{8} \times \frac{1}{2}$	14 $\frac{1}{4}$	Proxyship.....	Pruefbar	19.00	Prueggio.....	21.50
$\frac{5}{8} \times \frac{3}{4}$	15	Prozent.....	18.00	Pruefen	19.00	Prugnolo	21.50
$\frac{3}{4}$	16 $\frac{1}{4}$	Prozenten.....	23.00	Prueffing.....	24.00	Pruido.....	26.50
1	30	Prude	42.00	Pruefstein.....	46.00	Pruikenet.....	49.00
$1\frac{1}{4}$	49	Prudencio.....	Pruefung.....	73.00	Pruikerig.....
$1\frac{1}{2}$	54	Prudencio.....	Pruefzeit	110.00	Pruimers.....

 $\frac{1}{2}$ to 1-inch, one half-dozen in a package ; larger than 1-inch, loose.**1961-C.****WITH SHOULDER FOR IRON PIPE.**

Size, Inches.	Weight Per Dozen, Lbs.	Rough.		Finished.		Nickel-Plated.	
		Code.	Per Dozen.	Code.	Per Dozen.	Code.	Per Dozen.
$\frac{1}{2}$	11	Proverbes.....	\$12.50	Provicaire	\$13.00	Provinz.....	\$15.50
$\frac{3}{8} \times \frac{1}{2}$	11 $\frac{1}{2}$	Proverbial	Providebis.....	16.00	Provisour.....	18.50
$\frac{5}{8} \times \frac{3}{4}$	12	Proverbium.....	Provienes.....	16.00	Provisivo.....	18.50
$\frac{3}{4}$	16	Proversum.....	19.00	Provient.....	20.00	Provisora.....	22.50
1	30	Provianda	36.00	Provigner.....	40.00	Provistas.....	43.00

One-half dozen in a box.

In Orders and Specifications give Plate Numbers and Sizes.

COMPRESSION HOSE BIBBS.

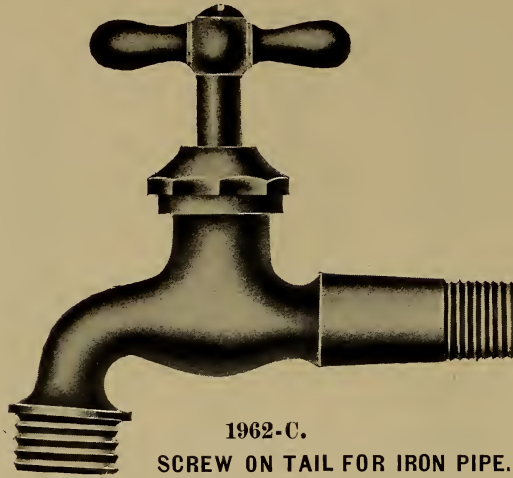

1962-C.
SCREW ON TAIL FOR IRON PIPE.

Size, Inches.	Weight Per Dozen, Lbs.	Rough.		Finished.		Nickel-Plated.	
		Code.	Per Dozen.	Code.	Per Dozen.	Code.	Per Dozen.
1/2	12	Pruinose.....	\$ 16.50	Prunella	\$17.00	Prunkhalle.....	\$19.50
5/8 x 1/2	15	Pruinosos.....	20.00	Prunelles	21.00	Prunkliebe.....	23.50
5/8 x 3/4	15	Pruinosum.....	20.00	Prunetto	21.00	Prunklos	23.50
3/4	17	Pruivel	25.00	Pruniceum.....	26.00	Prunksaal.....	28.50
1	33 1/2	Prullig	45.00	Pruniforme.....	49.00	Prunkspeil.....	52.00
1 1/4	54	Prumnides.....	69.00	Prunkbett	Prunksucht
1 1/2	60	Prumulace	104.00	Prunkend.....	Prunktitel.....
2	...	Pruneaux	210.00	Prunkhaft.....	Prunkvoll.....

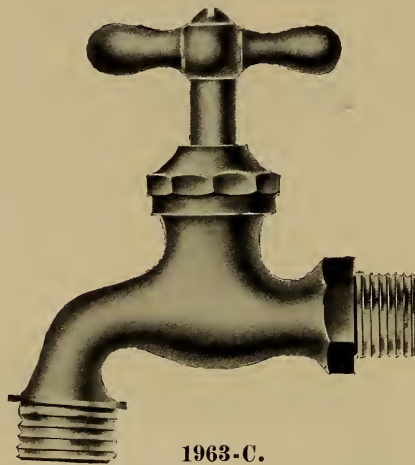

1963-C.
WITH SHOULDER FOR IRON PIPE.

Size, Inches.	Weight Per Dozen, Lbs.	Rough.		Finished.		Nickel-Plated.	
		Code.	Per Dozen.	Code.	Per Dozen.	Code.	Per Dozen.
1/2	11 1/2	Provocable.....	\$14.50	Provocola.....	\$15.00	Provulgas.....	\$17.50
5/8 x 1/2	14	Provocamos.....	Provulgabo.....	Provulgen.....
5/8 x 3/4	15 1/2	Provocante.....	17.00	Provolgés.....	18.00	Prowess.....	20.50
3/4	16 1/2	Provocarlo.....	21.00	Provolutos.....	22.00	Proxene.....	24.50
1	33	Provocarón.....	39.00	Provolvis.....	43.00	Proxenos.....	46.00
1 1/4	50	Provocatif	61.00	Provomunt.....	Proximal.....
1 1/2	55	Provocava	94.00	Provoquer.....	Proximista.....
2	Provoces	190.00	Provostry.....	Proximo.....

All on this page 1/2 to 1-inch, one-half dozen in a box; larger, loose.

In Orders and Specifications give Plate Numbers and Sizes.

COMPRESSION PLAIN BIBBS.

† 1967-C.

SHOULDER FOR IRON PIPE WITH STUFFING BOX.

Size, Inches.	Weight Per Dozen, Lbs.	Finished.		Nickel-Plated.	
		Code.	Per Dozen.	Code.	Per Dozen.
$\frac{1}{2}$	12	Prunkwerk	\$16.00	Prunulis	\$18.50
$\frac{3}{4}$	18 $\frac{3}{4}$	Prunophore	24.00	Prusianos	26.50
1	40	Prunosa	46.00	Prusica	49.00

One-half dozen in a box.



† 1968-C.

SCREW ON TAIL FOR IRON PIPE WITH STUFFING BOX.

Size, Inches.	Weight Per Dozen, Lbs.	Finished.		Nickel-Plated.	
		Code.	Per Dozen.	Code.	Per Dozen.
$\frac{1}{2}$	12 $\frac{1}{4}$	Prussiates	\$18.00	Pruttelig	\$20.50
$\frac{3}{4}$	19 $\frac{1}{2}$	Prussique	28.00	Prutzeln	30.50
1	41	Prutenic	52.00	Prymnesia	55.00

One-half dozen in a box.

† Carried in San Francisco only.

In Orders and Specifications give Plate Numbers and Sizes.

“MONARCH” COMPRESSION BIBBS.

BEST QUALITY RED METAL, HIGHLY POLISHED AND FINISHED. FULL SIZED WATER WAY. RAISED AND COUNTER-SUNK SEAT. SQUARE, WELL FITTED THREADS. ARTISTIC DESIGN.

We Guarantee “Monarch” Bibbs.

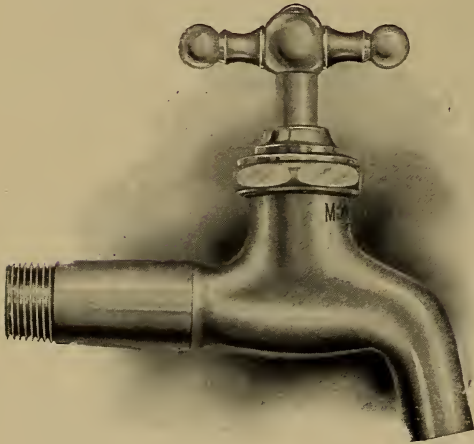

1971-C.



1972-C.

“MONARCH” COMPRESSION PLAIN BIBBS—1971-C.

Screw on Tail for Iron Pipe.

Size, Inches.	Weight Per Dozen, Lbs.	Finished.		Nickel-Plated.	
		Code.	Per Dozen.	Code.	Per Dozen.
1/2	13 1/2	Psacalion.....	\$15.00	Psadiroma	\$17.50
5/8 x 1/2	14 1/4	Psacastes.. ..	19.00	Psalidio	21.50
5/8 x 3/4	Psacum	19.00	Psallebet	21.50

One-half dozen in a box.

“MONARCH” COMPRESSION HOSE BIBBS—1972-C.

Screw on Tail for Iron Pipe.

Size, Inches.	Weight Per Dozen, Lbs.	Rough.		Finished.		Nickel-Plated.	
		Code.	Per Dozen.	Code.	Per Dozen.	Code.	Per Dozen.
1/2	14	Psallendum.....	\$16.50	Psallimus	\$17.00	Psalmata.....	\$19.50
5/8 x 1/2	15 1/2	Psallerunt	20.00	Psallist	21.00	Psalmatis	23.50
5/8 x 3/4	Psallette	20.00	Psallunt.....	21.00	Psalmatum.....	23.50

One-half dozen in a box.

In Orders and Specifications give Plate Numbers and Sizes.

NICKEL-PLATED BATH BIBBS.

COMPRESSION.

FULLER.

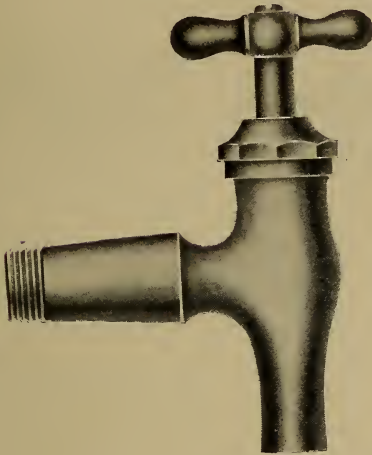

1976-C.

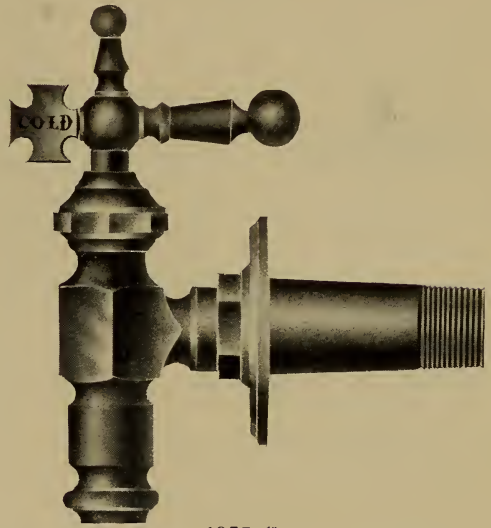

1977-C.

†Screw on Tail for Iron Pipe.

†Screw on Tail for Iron Pipe with Adjustable Flange.

Code	Psalmbock	Psalmbuch
Size, inches.....	½	⅝ x ¾
Per dozen.....	\$21.50	26.50
Weight per dozen, lbs.....	11	16½

Code.....	Psalmear	Psalmicen	Psalmique
Size, inches.....	⅝ x ½	⅝ x ¾	¾
Per dozen.....	\$45.00	45.00	56.00
Wt. per doz., lbs...	15½	18	23

One-half dozen in a box.

BRASS EXTENSION PIECES.

MALE AND FEMALE I. P. THREADS.



1978-C.

Length, 2 Inches.

Finished.

†Nickel-Plated.

Code.....	Psalmista	Psalmistis
Size, inches.....	½	¾
Per dozen.....	\$6.00	12.00
Weight per dozen, lbs.....	2¼	3

Code.....	Psalmodiari	Psalmodize
Size, inches.....	½	¾
Per dozen.....	\$8.00	14.00
Weight per dozen, lbs.....	2¼	3

One dozen in a package.

†Carried in San Francisco only.

In Orders and Specifications give Plate Numbers and Sizes.

TRIMMINGS FOR COMPRESSION WORK.

FANCY HANDLES.



† 1981-C.
Four Arm.



† 1982-C.
Plain Wheel.



† 1983-C.
Tee.



† 1984-C.
China Plate—Four Arm.

Code.....	Psalteria	Psamathos	Psamma	Psammenit
Plate number.....	1981-C.	1982-C.	1983-C.	1984-C.
Per dozen.....	\$4.00	5.00	2.00	14.00
Add to price of Tee Handle Cocks, per dozen.....	\$2.00	3.00	12.00

BIBB WASHERS.



1985-C.

BOSS BIBB WASHERS.

Code.....	Psammode	Psammodus	Psammures	Psaphis	Psaphon
Size, inches.....	3/8	1/2	5/8	3/4	1
Per dozen.....	\$0.20	.20	.20	.25	.30

One hundred in a box.

† **VULCANIZED FIBER BIBB WASHERS.**

Code.....	Psarani	Psaranos	Psarisome	Psarolite	Psaronio
Size, inches.....	3/8	1/2	5/8	3/4	1
Per dozen.....	\$0.30	.30	.30	.35	.40

One gross in a box.

† Carried in San Francisco only.

In Orders and Specifications give Plate Numbers and Sizes.

LEVER BIBBS.

GROUND KEY. CAST HANDLE.

**1990-C.****PLAIN, FOR LEAD PIPE.**

Size, Inches.	Weight Per Dozen, Lbs.	Finished.		Nickel-Plated.	
		Code.	Per Dozen.	Code.	Per Dozen.
¼	4	Psatura	\$13.50	Pselions	\$15.00
⅜	7½	Psautier	15.50	Psellisme	17.00
½	12	Pseboa	18.00	Psenerus	20.00
⅝	13	Psecade	21.50	Psephisme.....	24.00
¾	16	Pselafu	29.00	Psephite	32.00
†1	26	Pselchis	41.00	Psephobole	45.00

One-half dozen in a package.

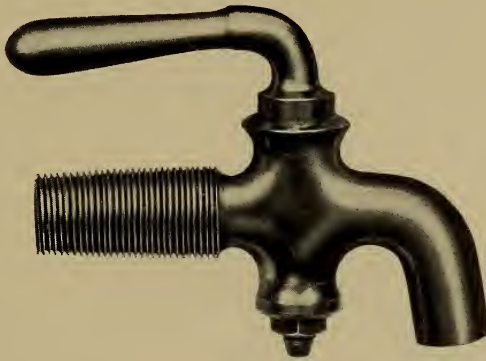
**†1991-C.****PLAIN, SCREWED FOR WOOD.**

Size, Inches.	Weight Per Dozen, Lbs.	Finished.		Nickel-Plated.	
		Code.	Per Dozen.	Code.	Per Dozen.
¼	4	Psesques	\$14.50	Pseudaspis	\$16.00
⅜	7½	Psettarum	16.50	Pseudehis	18.00
½	12	Psettis.....	20.00	Pseudelaps	22.00
⅝	13	Pseudanthe	24.50	Pseuderyx	27.00
¾	16	Pseudarade	33.00	Pseudiosma.....	36.00

One-half dozen in a package.

† Carried in San Francisco only.

In Orders and Specifications give Plate Numbers and Sizes.

LEVER PLAIN BIBBS.

GROUND KEY. CAST HANDLE.



1992-C.



† 1993-C.

SCREW ON TAIL FOR IRON PIPE—1992-C.

Size, Inches.	Weight Per Dozen, Lbs.	Rough.		Finished.		Nickel-Plated.	
		Code.	Per Dozen.	Code.	Per Dozen.	Code.	Per Dozen.
¼	4	Pseudocato	\$.....	Pseudopape.....	\$14.50	Pseutes	\$16.00
⅜	7 ½	Pseudodox.....	15.00	Pseudopata	16.50	Psiadia	18.00
½	12 ½	Pseudogyne.....	18.00	Pseudopsis.....	20.00	Psiathium.....	22.00
† ⅝ x ½	13 ½	Pseudolien.....	22.00	Pseudornis.....	24.50	Psiche	27.00
⅝ x ¾	14	Pseudology.....	22.00	Pseudosmia.....	24.50	Psichico.....	27.00
¾	16	Pseudome.....	30.00	Pseudova.....	33.00	Psichine	36.00
† 1	27 ½	Pseudomeno.....	43.00	Pseudovum.....	47.00	Psidium.....	51.00
† 1 ¼	46	Pseudomops	Pseudozene	78.00	Psilagie.....	88.00

One-half dozen in a package.

WITH SHOULDER FOR IRON PIPE—1993-C.

Size, Inches.	Weight Per Dozen, Lbs.	Rough.		Finished.		Nickel-Plated.	
		Code.	Per Dozen.	Code.	Per Dozen.	Code.	Per Dozen.
¼	4	Psilarum.....	\$.....	Psilopogon.....	\$13.50	Psoadic.....	\$15.00
⅜	7	Psiletas	14.00	Psiloptere.....	15.50	Psodymes.....	17.00
½	12	Psilobon	16.00	Psilosomes	18.00	Psomeles.....	20.00
⅝ x ½	13	Psiloceres.....	19.00	Psilostome.....	21.50	Psophides.....	24.00
⅝ x ¾	15	Psilomydes	19.00	Psilothre.....	21.50	Psophis.....	24.00
¾	16	Psilonotes	26.00	Psilothris.....	29.00	Psychical	32.00
1	26	Psilopes.....	37.00	Psilothron	41.00	Psychicos.....	45.00
1 ¼	44	Psilopiles.....	60.00	Psilothrum	70.00	Psychicum
1 ½	50	Psilopodes.....	90.00	Psilures.....	110.00	Psychology
2	53	Psilopofar.....	180.00	Psimithia	210.00	Psychosis.....

¼-inch to 1-inch, one-half dozen in a package.

† Carried in San Francisco only.

In Orders and Specifications give Plate Numbers and Sizes.

LEVER HOSE BIBBS.

GROUND KEY. CAST HANDLE.

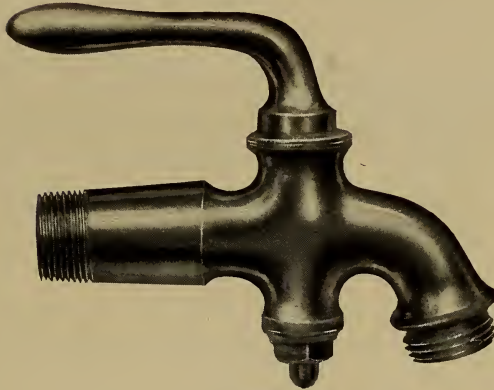

1994-C.

SCREW ON TAIL FOR IRON PIPE.

Size, Inches.	Weight Per Dozen, Lbs.	Rough.		Finished.		Nickel-Plated.	
		Code.	Per Dozen.	Code.	Per Dozen.	Code.	Per Dozen.
1/2	13	Ptarmico.....	\$ 20.00	Puberal	\$22.00	Publicorne.....	\$24.00
† 5/8 x 1/2	13	Ptarmigan	Puberdade	26.50	Pubiflore	29.00
5/8 x 3/4	13 1/2	Ptarmique	24.00	Pubertas	26.50	Pubigere.....	29.00
3/4	17	Ptanteur.....	33.00	Pubertatis	36.00	Publiable	39.00
1	30	Publicano	48.00	Puberty.....	52.00	Publicaba.....	56.00
1 1/4	50	Publicare	74.00	Puberulent.....	Publicador.....
† 1 1/2	52	Publicava.....	108.00	Pubescente	Publicamos
† 2	55	Publico	215.00	Pubescunt	Publicar

1/2-inch to 1-inch, one-half dozen in a box.

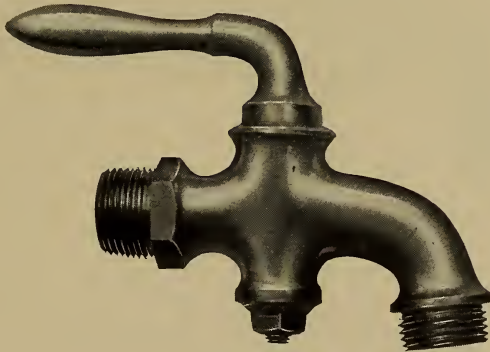

†1995-C.

WITH SHOULDER FOR IRON PIPE.

Size, Inches.	Weight Per Dozen, Lbs.	Rough.		Finished.		Nickel-Plated.	
		Code.	Per Dozen.	Code.	Per Dozen.	Code.	Per Dozen.
1/2	12	Publicaron.....	\$18.00	Publicness	\$20.00	Publicurs	\$22.00
5/8 x 3/4	15 1/2	Publiciano	21.00	Publicola	23.50	Publikum	26.00
3/4	16	Publicista.....	29.00	Publicorum	32.00	Publipor	35.00
1	24 1/2	Publicitus	42.00	Publierons	46.00	Publiporem	50.00

One-half dozen in a package.

†Carried in San Francisco only.

In Orders and Specifications give Plate Numbers and Sizes.

LEVER WASH TRAY BIBBS.

GROUND KEY. CAST HANDLE.



†1998-C.

Cut Shows Right Hand.

WITH SCREW ON TAIL FOR IRON PIPE.

Size, Inches.	Weight Per Dozen, Lbs.	Finished.		Nickel-Plated.	
		Code.	Per Dozen.	Code.	Per Dozen.
3/8	8 1/2	Publiporis.....	\$17.00	Pucelles.....	\$18.50
1/2	11 1/2	Publique.....	22.00	Puchapat.....	24.00
5/8 x 1/2	13	Pucarinha.....	27.00	Puchar.....	29.50
5/8 x 3/4	15	Pucaro.....	27.00	Pucheras.....	29.50
3/4	18	Puccoon.....	37.00	Pucheux.....	40.00

One each Right and Left Hand always sent unless otherwise specified.

One-half dozen in a box.

FULLER WASH TRAY BIBBS.

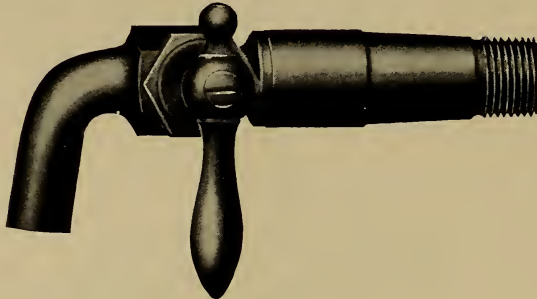

1999-C.

Cut Shows Right Hand.

WITH SCREW ON TAIL FOR IRON PIPE.

Size, Inches.	Weight Per Dozen, Lbs.	Finished.		Nickel-Plated.	
		Code.	Per Dozen.	Code.	Per Dozen.
1/2	12 1/2	Puchoir.....	\$25.00	Puddelst.....	\$29.00
† 5/8 x 1/2	12 1/2	Puckerred.....	30.00	Puddlage.....	34.00
5/8 x 3/4	13 1/2	Puckering.....	30.00	Puddleurs.....	34.00
3/4	18	Puddeln.....	38.00	Pudebunt.....	44.00

One each Right and Left Hand always sent unless otherwise specified.

One-half dozen in a box.

†Carried in San Francisco only.

In Orders and Specifications give Plate Numbers and Sizes.

COMPRESSION WASH TRAY BIBBS.



2000-C.

STRAIGHT PATTERN WITH SCREW ON TAIL FOR IRON PIPE.

Size, Inches.	Weight Per Dozen, Lbs.	Finished.		Nickel-Plated.	
		Code.	Per Dozen.	Code.	Per Dozen.
1/2	10	Pudefactos.....	\$16.00	Pudelnass.....	\$18.50
† 5/8 x 1/2	12 1/2	Pudefactum.....	20.00	Pudendus.....	22.50
5/8 x 3/4	14	Pudelhund.....	20.00	Puderig.....	22.50
3/4	16 1/2	Pudelkopf.....	25.00	Pudescit.....	27.50

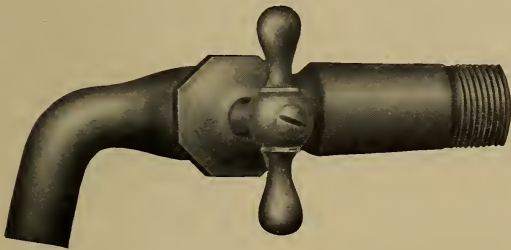

† **2001-C.**

Cut shows Right Hand.

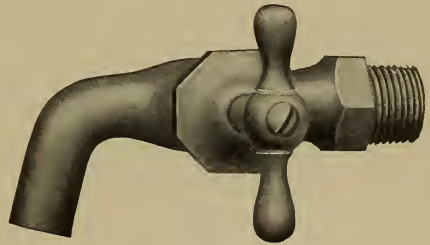

† **2002-C.**

Cut shows Right Hand.

SIDE HANDLE PATTERN WITH SCREW ON TAIL FOR IRON PIPE—2001-C.

Size, Inches.	Weight Per Dozen, Lbs.	Finished.		Nickel-Plated.	
		Code.	Per Dozen.	Code.	Per Dozen.
1/2	10	Pudeur.....	\$18.00	Pudibondas.....	\$20.50
† 5/8 x 1/2	13	Pudibile.....	22.00	Pudibundo.....	24.50
5/8 x 3/4	14 1/2	Pudibillis.....	22.00	Pudique.....	24.50
3/4	17 1/2	Pudibond.....	27.00	Pudleaba.....	29.50

One each Right and Left Hand always sent unless otherwise specified.

SIDE HANDLE PATTERN WITH SHOULDER FOR IRON PIPE—2002-C.

Size, Inches.	Weight Per Dozen, Lbs.	Finished.		Nickel-Plated.	
		Code.	Per Dozen.	Code.	Per Dozen.
1/2	9 1/2	Pudleador.....	\$16.00	Pudlearian.....	\$18.50
5/8 x 3/4	12 1/2	Pudleamos.....	19.00	Pudleos.....	21.50

One each Right and Left Hand always sent unless otherwise specified.

All this page, one-half dozen in a box.

† Carried in San Francisco only.

In Orders and Specifications give Plate Numbers and Sizes.

“MONARCH” COMPRESSION WASH TRAY BIBBS.

BEST QUALITY RED METAL. HIGHLY POLISHED AND FINISHED. RAISED AND COUNTER-SUNK SEAT FULL SIZED WATERWAY. SQUARE, WELL-FITTING THREADS. ARTISTIC DESIGN. TESTED AND GUARANTEED.

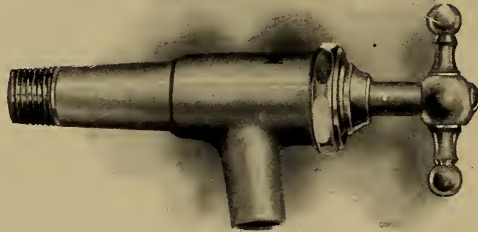

2005-C.

STRAIGHT PATTERN WITH SCREW ON TAIL FOR IRON PIPE.

Size, Inches.	Weight Per Dozen, Lbs.	Finished.		Nickel-Plated.	
		Code.	Per Dozen.	Code.	Per Dozen.
1/2 5/8 x 3/4	12	Pudoratos	\$16.00	Pudorosas	\$18.50
	13 1/2	Pudoratum	20.00	Pudrian	22.50

One-half dozen in a box.

“MONARCH” FULLER WASH TRAY BIBBS.

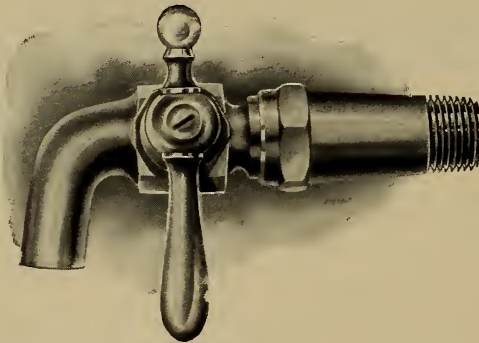

2006-C.

Cut Shows Right Hand.

WITH SCREW ON TAIL FOR IRON PIPE.

Size, Inches.	Weight Per Dozen, Lbs.	Finished.		Nickel-Plated.	
		Code.	Per Dozen.	Code.	Per Dozen.
1/2 5/8 x 3/4	Pudridero	\$25.00	Puellitor.....	\$29.00
	Puellasco	30.00	Puellum	34.00

One each Right and Left Hand always sent unless otherwise specified.

One-half dozen in a box.

In Orders and Specifications give Plate Numbers and Sizes.

DOHERTY SELF-CLOSING BIBBS.

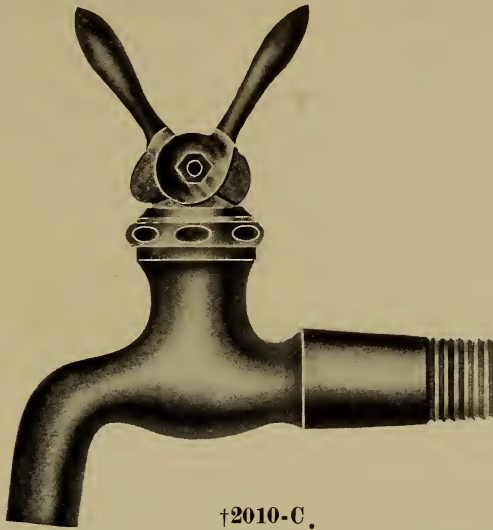

†2010-C.

PLAIN WITH SCREW ON TAIL FOR IRON PIPE.

Size, Inches.	Weight Per Dozen, Lbs.	Finished.		Nickel-Plated.	
		Code.	Per Dozen.	Code.	Per Dozen.
1/2	13 1/2	Puentes	\$29.00	Puerascunt.....	\$35.00
5/8 x 3/4	16 1/2	Puerasco	33.00	Puerculos.....	39.00

One-half dozen in a package.

MOORE'S SELF-CLOSING BIBBS.

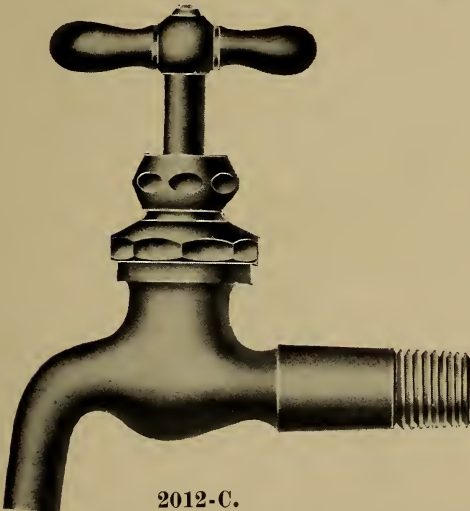

2012-C.

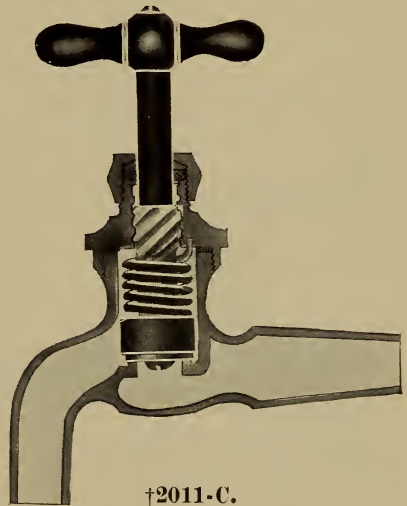

†2011-C.

PLAIN WITH SCREW ON TAIL FOR IRON PIPE.

Size, Inches.	Weight Per Dozen, Lbs.	Finished.		Nickel-Plated.	
		Code.	Per Dozen.	Code.	Per Dozen.
1/2	13	Puerility	\$29.00	Pueriliser.....	\$35.00
5/8 x 3/4	17	Puerilium	33.00	Puerilizam	39.00

One-half dozen in a box.

The above sectional cut illustrates the construction of Moore's Self-Closing Work. A peculiarity of this work is that the spring is operated both by Tension and Torsion, thus having a double power to close the valve to its seat.

†Carried in San Francisco only.

In Orders and Specifications give Plate Numbers and Sizes.

TELEGRAPH SELF-CLOSING BIBBS.

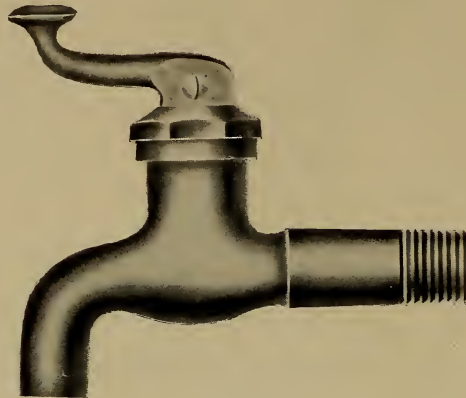

†2015-C.

PLAIN WITH SCREW ON TAIL FOR IRON PIPE.

Size, Inches.	Weight Per Dozen, Lbs.	Finished.		Nickel-Plated.	
		Code.	Per Dozen.	Code.	Per Dozen.
3/8	10	Puffender	\$.....	Puffwagen	\$21.00
1/2	11 1/2	Puffery	20.00	Pufferite	24.00
5/8 x 1/2	15	Puffingly	24.00	Puggi	28.00
5/8 x 3/4	16	Puffinure	24.00	Pugilabor	28.00
3/4	16 1/2	Puffspiel	32.00	Pugilamur	38.00

One-half dozen in a package.

TELEGRAPH SELF-CLOSING COOLER COCKS.

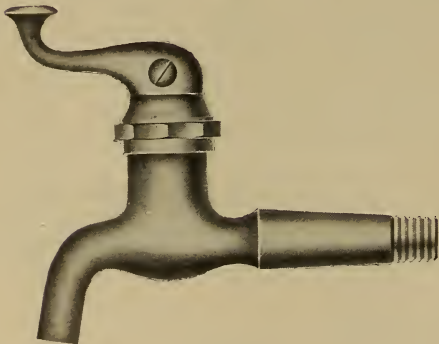

†2016-C.

WITH SCREW ON TAIL FOR IRON PIPE.

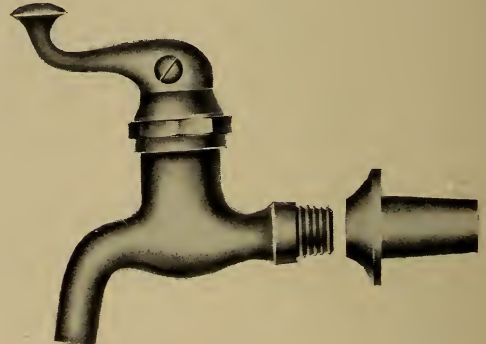

†2017-C.

WITH FLANGE TO SOLDER.

Code.....	Pugilato	Pugilista
Size, inches.....	1/2 x 3/8	5/8 x 1/2
Per dozen.....	\$17.50	20.50
Weight, per dozen, lbs.....	9	11 1/2

Code.....	Pugilistes	Pugillarem
Size, inches.....	3/8	1/2
Per dozen.....	\$16.00	18.50
Weight per dozen, lbs.....	9	10

One-half dozen in a package.

†Carried in San Francisco only.

In Orders and Specifications give Plate Numbers and Sizes.

PUSH AND PULL VALVES.

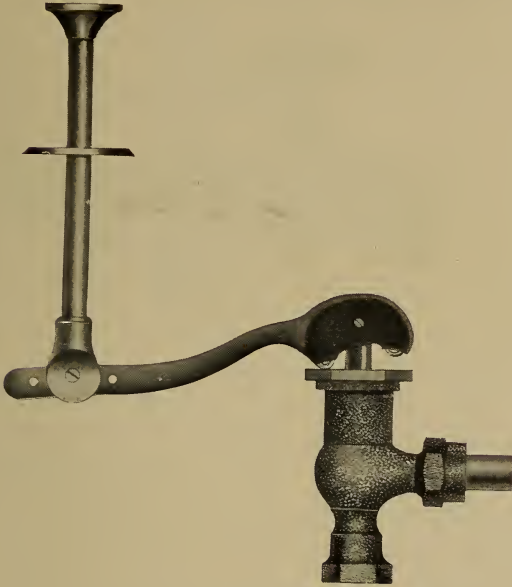

†2020-C.

FOR LEAD AND IRON PIPE WITH COUPLING AND FINISHED FLANGE AND HANDLE.

Code.....	Pugillaris
Size, inch.....	½
Per dozen.....	\$30.00
Weight per dozen, lbs.....	19

Loose.

HOPPER VALVES.

FOR LEAD AND IRON PIPE WITH COUPLING, AND FINISHED FLANGE AND HANDLE.

Code.....	Pugillator
Size, inch.....	½
Per dozen.....	\$30.00
Weight per dozen, lbs.....

Loose.

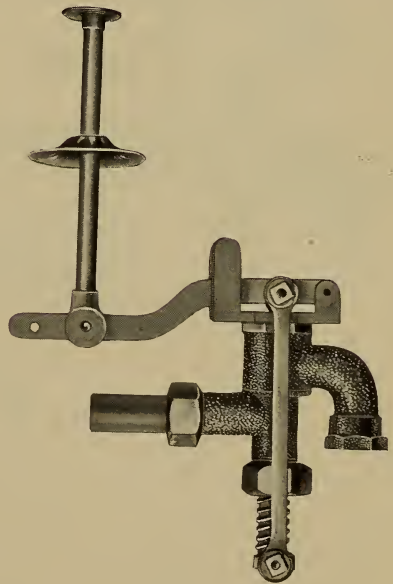

†2021-C.

†Carried in San Francisco only.

In Orders and Specifications give Plate Numbers.

RACKING COCKS.

GROUND KEY. NUT AND WASHER. FINISHED BRASS.

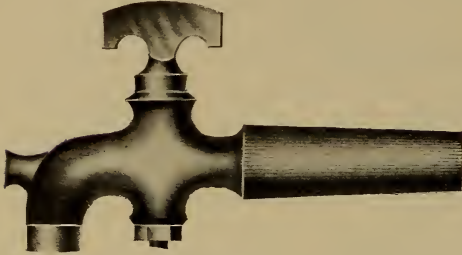

†2025-C.
To Drive.

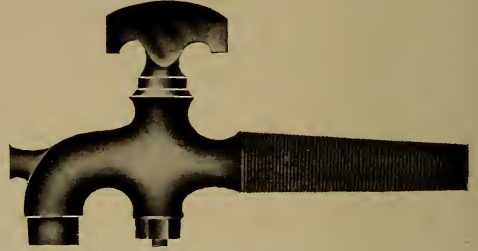

†2026-C.
To Screw.

RACKING COCKS TO DRIVE—2025-C.

Code	Pugille	Pugillum	Pugionem	Pugionies	Pugnabilis
Size, inches.....	¼	⅜	½	⅝	¾
Per dozen.....	\$10.00	12.00	15.00	20.00	29.00
Weight per dozen, lbs.....	3	6	8	11	12½

RACKING COCKS TO SCREW—2026-C.

Code	Pugnacious	Pugnacite	Pugnacula	Pugnalande	Pugnalassi
Size, inches.....	¼	⅜	½	⅝	¾
Per dozen	\$10.50	12.50	16.00	21.50	31.00
Weight per dozen, lbs.....	3	6	8	11	12½

One-half dozen in a box.

LOCK COCKS.

GROUND KEY. NUT AND WASHER. FINISHED BRASS.

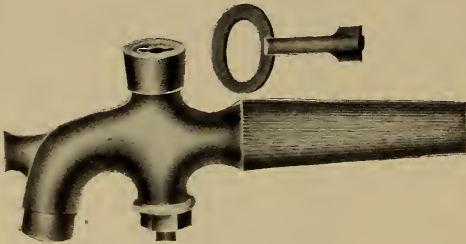

†2027-C.
To Drive.

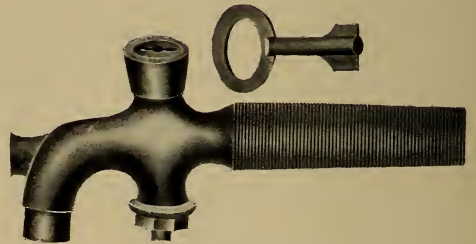

†2028-C.
To Screw.

LOCK COCKS TO DRIVE—2027-C.

Code.....	Pugnolato	Pugnalone	Pugnalocto	Pugnassi
Size, inches.....	⅜	½	⅝	¾
Per dozen	\$14.00	17.00	22.00	31.00
Weight per dozen, lbs.....	5½	8	10	15

LOCK COCKS TO SCREW—2028-C.

Code	Pugnatore	Pugnatrice	Pugnava	Pugnavano
Size, inches.....	⅜	½	⅝	¾
Per dozen	\$14.50	18.00	23.50	33.00
Weight per dozen, lbs.....	5½	8	10	15

One-half dozen in a package.

†Carried in San Francisco only.

In Orders and Specifications give Plate Numbers and Sizes.

URN COCKS.

NICKEL-PLATED. GROUND KEY.

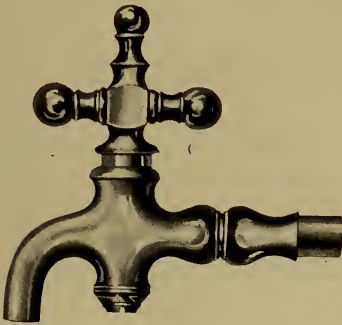

2031-C.

RUBBER TEE HANDLE.

Code	Pugnazzo	Pugnello	Pugniamo
Size, inches.....	¼	⅜	½
Per dozen.....	\$14.00	16.00	22.50
Weight per doz., lbs.	4	5½	9

One-half dozen in a box.

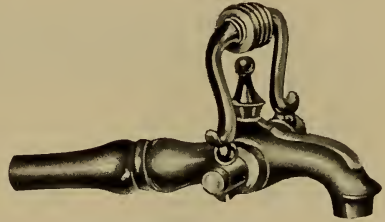

2032-C.

IVORY DROP HANDLE.

Code.....	Pugnitivo
Size, inches.....	⅜
Per dozen	\$34.00
Weight per dozen, lbs.....	5

One-half dozen in a box.

COMPRESSION OIL COCKS.

IRON TIN-PLATED.

Code.....	Pugnitopo
Size, inches.....	¼
Per dozen	\$4.50
Weight per dozen, lbs.....	2

One dozen in a box.



2033-C.

With Flange to Solder.

HOT MILK COCKS.



2034-C.

SIDE HANDLE WITH WOOD BAR.

Size, Inches.	Weight•Per Dozen, Lbs.	Finished.		Nickel-Plated.	
		Code.	Per Dozen.	Code.	Per Dozen.
½	Puissance.....	\$30.00	Pujaminto.....	\$33.50
⅜	Puissant	34.00	Pujanca.	37.50
¾	9½	Pujadores.....	43.00	Pujante.....	47.00

One-half dozen in a package.

These Cocks may be readily cleaned by removing the cap on the end, thus opening a passage through the entire body of the cock.

In Orders and Specifications give Plate Numbers and Sizes.

AIR COCKS.

POLISHED BRASS.



2037-C.

Threaded one end for Iron Pipe.

Code.....	Pujarais	Pujaremos	Pujavante	Pulcelaje
Size, inches..	1/8	1/4	3/8	1/2
Each.....	\$0.40	.40	.50	.60
Wt. per doz., lbs.

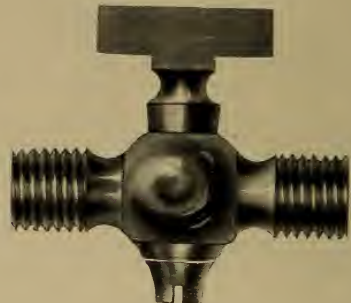

2038-C.

Threaded both ends for Iron Pipe.

Code.....	Pulcella	Pulcellum	Pulchello	Pulchellus
Size, inches..	1/8	1/4	3/8	1/2
Each.....	\$0.55	.55	.65	.90
Wt. per doz., lbs.

One dozen in a box.

AIR VALVES.

BRASS POLISHED AND NICKEL-PLATED.

PERFECTED DUPLEX.



† 2041-C.

Lock Shield Automatic Air Valve for Steam. Has a special key for adjusting the valve. Threaded for 1/8-inch pipe.

Code.....	Pulchresco
Number.....	6
Each.....	\$2.00
Weight per box, lbs.....	3 1/2

Twelve in a box.

† Carried in San Francisco only.

BADGE.



Perfect Duplex Air Valves carry the above trade mark and are guaranteed for five years. Will not leak water or steam. The only brand of Air Valves having a separate air tube (an essential feature) extending from the interior of the radiator to above the top of the float on inside of valves, which equalizes the pressure and causes the water to flow back into the radiator instead of on the floors and carpets.



† 2042-C.

Automatic Float and Expansion Air Valve. A cheap, but well made valve. Threaded for 1/8-inch pipe.

Code.....	Pulchritas
Each.....	\$1.00
Weight per box, lbs.....	2 1/2

Twelve in a box.

In Orders and Specifications give Plate Numbers and Sizes.

LEVER BALL COCKS.

GROUND KEY. NUT AND WASHER.



2055-C.

With Shoulder for Iron Pipe.



2056-C.

Screw on Tail for Iron Pipe.

† WITH SHOULDER FOR IRON PIPE—2055-C.

Code.....	Pulcino	Pulcras	Pulejatos	Pulejatam	Pulejum
Size, inches.....	$\frac{3}{8}$	$\frac{1}{2}$	$\frac{5}{8} \times \frac{3}{4}$	$\frac{3}{4}$	1
Per dozen	\$18.00	20.00	25.00	33.00	47.00
Weight per dozen, lbs.....	6	$9\frac{1}{2}$	12	14	26

WITH SCREW ON TAIL FOR IRON PIPE—2056-C.

Code.....	Pulendo	Pulgada	Pulgones	Pulgosas	Pulguenta
Size, inches.....	$\dagger \frac{3}{8}$	$\frac{1}{2}$	$\frac{5}{8} \times \frac{3}{4}$	$\frac{3}{4}$	1
Per dozen	\$19.00	22.00	28.00	37.00	53.00
Weight per dozen, lbs.....	6	9	12	14	26

IMPROVED COMPRESSION BALL COCKS.

WITH STEMS AND SPUDS.



2057-C.

WITH SCREW ON TAIL FOR IRON PIPE.

Code.....	Pulguillas	Puliamos	Pulicibus	Pulicide	Pulicosum	Pulidez
Size, inches	$\frac{1}{2}$	$\frac{3}{4}$	1	$\dagger 1\frac{1}{4}$	$\dagger 1\frac{1}{2}$	$\dagger 2$
Per dozen.....	\$16.00	28.00	42.00	68.00	100.00	190.00
Weight per dozen, lbs.....	10	14	18	38	50	100

$\frac{1}{2}$ -inch to 1-inch inclusive have stems 10 inches long, thread $\frac{7}{16}$ -inch, 20 threads to the inch.

$1\frac{1}{4}$ -inch to 2-inch inclusive have stems 12 inches long, $\frac{1}{8}$ -inch Iron Pipe.

†Carried in San Francisco only.

In Orders and Specifications give Plate Numbers and Sizes.

“FOSTER” PATENT BALL COCK OR FLOAT VALVE.

BRASS. HIGH AND LOW PRESSURE.

Used in receiving and supply tanks, or wherever the flow of water is to be controlled **auto-**
matically. No springs.

Pressures varying from 5 to 250 lbs. per square inch are successfully controlled by the “Foster”
Ball Cock. A 4-inch Ball is sufficiently large to operate the largest sizes made, as it is only used to
open or close the auxiliary valve.

Positive in action. Works easily and noiselessly.

A strainer keeps out sediment. Corrugations on the little wheel at the side hold the ball rod
firmly at any angle—you don’t have to bend the rod.

A variation of but half an inch in the water level will cause the valve to open full or close.

How they operate: When both the main valve and auxiliary valve are closed, the pressure
in the upper part of the valve chamber is substantially the same as in the inlet pipe.

If the auxiliary valve be opened by falling of the float or any other means, the pressure in the
upper part of the valve chamber is at once relieved and reduced below the pressure in the inlet pipe.

The difference in the pressure on the upper side of the piston and the under side of the piston,
causes the piston to be lifted to its highest position in the valve chamber, thus opening the main valve.

When the auxiliary valve is closed by the rising of the float or any other means, the water is
forced into the upper part of the valve chamber, between the piston and body of the valve, until the
pressures in the two parts of the valve chamber are equalized.

Then the piston is caused to move in the opposite direction and the valve is closed.

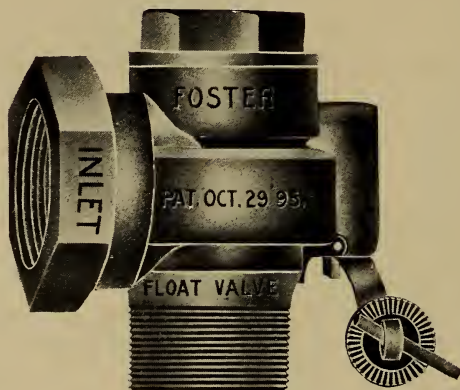

†2061-C.

FOR IRON PIPE.

Code	Puliran	Puliremo	Pulisse	Pulitore	Pulitura
Size, inches.....	$\frac{3}{4}$	1	$1\frac{1}{4}$	$1\frac{1}{2}$	2
Each.....	\$3.75	5.75	7.75	9.75	17.50
Weight each, lbs.....	$1\frac{1}{8}$	$1\frac{1}{2}$	$2\frac{1}{4}$	$3\frac{1}{4}$	$5\frac{3}{4}$

†Carried in San Francisco only.

In Orders and Specifications give Plate Numbers and Sizes.

COMPRESSION STOPS.

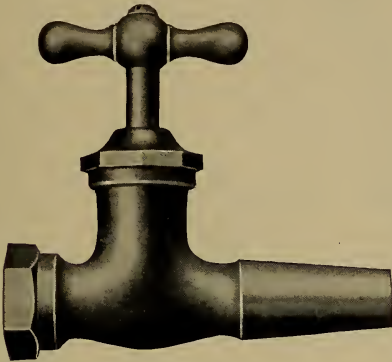

†2070-C.

Straight for Lead and Iron Pipe.

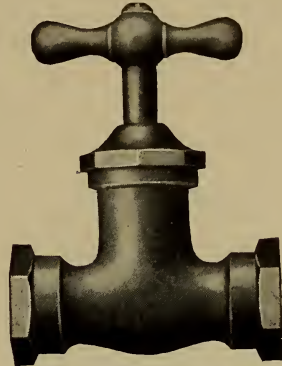

2071-C.

Straight for Iron Pipe.

†FOR LEAD AND IRON PIPE—2070-C.

Size, Inches.	Weight Per Dozen, Lbs.	Rough.		Finished.		Nickel-Plated.	
		Code.	Per Dozen.	Code.	Per Dozen.	Code.	Per Dozen.
1/2	11	Pullabunt.....	\$13.50	Pullaminis.....	\$14.00	Pullanen.....	\$16.50
3/4	16	Pullamina.....	23.00	Pullaminum....	24.00	Pullario.....	26.50

One-half dozen in a box.

FOR IRON PIPE—2071-C.

Size, Inches.	Weight Per Dozen, Lbs.	Rough.		Finished.		Nickel-Plated.	
		Code.	Per Dozen.	Code.	Per Dozen.	Code.	Per Dozen.
3/8	7 1/2	Pullastre.....	\$.....	Pullavit.....	\$.....	Pullicat.....	†\$15.00
1/2	9	Pullastris.....	†13.50	Pullback.....	14.00	Pullicenos.....	16.50
3/4	17	Pullatione.....	†23.00	Pullebroer.....	†24.00	Pullicenum.....	26.50
1	26 1/2	Pullavamus....	Pullejaceo.....	†43.00	Pulliginis.....	† 46.00

One-half dozen in a box.

†FOR IRON PIPE WITH ADJUSTABLE FLANGE.



†2072-C.

For Iron Pipe, With Adjustable Flange.

†Carried in San Francisco only.

Size, Inches.	Weight Per Dozen, Lbs.	Finished Flange and Handle.		Nickel-Plated Flange and Handle.	
		Code.	Per Dozen.	Code.	Per Dozen.
1/2	10	Pullinos.....	\$25.00	Pullities.....	\$27.50
3/4	21	Pullista.....	39.00	Pullulabis.....	41.50

One-half dozen in a box.

In Orders and Specifications give Plate Numbers and Sizes.

“MONARCH” COMPRESSION ANGLE STOPS.

BEST QUALITY RED METAL. HIGHLY POLISHED AND FINISHED. SQUARE, WELL-FITTED THREADS. ARTISTIC DESIGN.

We Guarantee “Monarch” Goods.



2075-C.

FINISHED FOR IRON PIPE.

Code.....	Pullulante
Size, inches.....	$\frac{3}{8} \times \frac{3}{4}$
Per dozen.....	\$17.00
Weight, per dozen, lbs.....

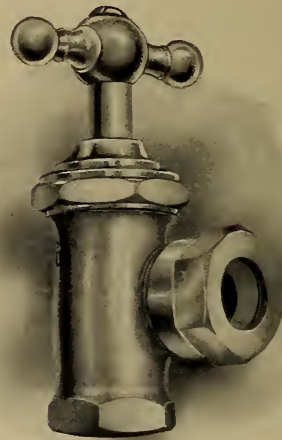

2076-C.

ONE END IRON PIPE, ONE END SLIP JOINT.

	Finished.	Nickel-Plated.
Code.....	Pullulatio	Pullulavit
Size, inches...	$\frac{1}{2}$ -in. I. P. x $\frac{1}{16}$ -in. slip	$\frac{1}{2}$ -in. I. P. x $\frac{1}{16}$ -in. slip
Per dozen.....	\$17.00	19.50
Wt. per doz., lbs..	12	12
	$\frac{1}{16}$ -inch slip takes $\frac{3}{8}$ -inch I. P.	

One-half dozen in a box.

LOOSE KEY COMPRESSION STOPS.

STRAIGHT FOR IRON PIPE.

	Finished.	
Code.....	Pullulos	Pullulum
Size, inches.....	$\frac{1}{2}$	$\frac{3}{4}$
Per dozen.....	\$20.00	31.00
Weight, per dozen, lbs.....	11	16

	Nickel-Plated.	
Code.....	Pulmograda	Pulmonaire
Size, inches.....	$\frac{1}{2}$	$\frac{3}{4}$
Per dozen.....	\$22.50	33.50

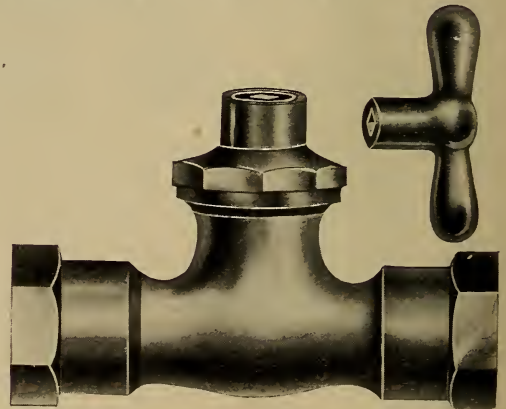

† 2080-C.

† Carried in San Francisco only.

In Orders and Specifications give Plate Numbers and Sizes.

DOHERTY SELF-CLOSING STOPS.

†2085-C.

FOR IRON PIPE.

Size, Inches.	Weight Per Dozen, Lbs.	Finished.		Nickel-Plated.	
		Code.	Per Dozen.	Code.	Per Dozen.
$\frac{1}{2}$ $\frac{5}{8} \times \frac{3}{4}$	13 $\frac{1}{2}$	Pulmonelle.....	\$30.00	Pulmonico	\$36.00
	16 $\frac{1}{2}$	Pulmonium.....	33.00	Pulmonifer	39.00

One-half dozen in a box.

MOORE'S SELF-CLOSING STOPS.

†2086-C.

FOR IRON PIPE.

Size, Inches.	Weight Per Dozen, Lbs.	Finished.		Nickel-Plated.	
		Code.	Per Dozen.	Code.	Per Dozen.
$\frac{1}{2}$ $\frac{3}{4}$	13	Pulpabat.....	\$30.00	Pulpation	\$36.00
	24	Pulparemus.....	42.00	Pulpaverat	49.00

One-half dozen in a box.

See page 515 for construction of Moore's self-closing work.

†Carried in San Francisco only.

In Orders and Specifications give Plate Numbers and Sizes.

LEVER STOPS.

GROUND KEY. CAST HANDLES. NUT AND WASHER.

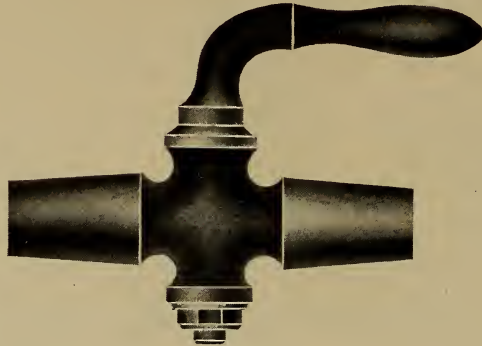

†2089-C.
For Lead Pipe.

†FOR LEAD PIPE—2089-C.

Size, Inches.	Weight Per Dozen, Lbs.	Finished.		Nickel-Plated.	
		Code.	Per Dozen.	Code.	Per Dozen.
3/8	6 1/2	Pulpemus.....	\$18.50	Pulpitamus.....	\$20.00
1/2	10	Pulpeux.....	21.00	Pulpiter.....	23.00
5/8	14	Pulpitabo.....	27.00	Pulpitical.....	29.50

One-half dozen in a box.

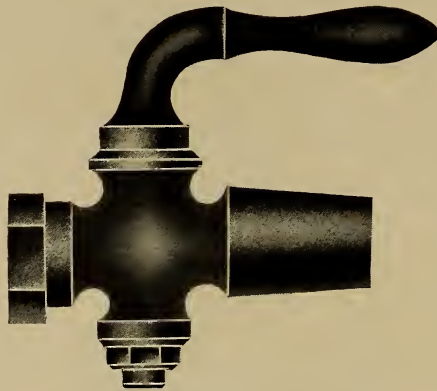

†2090-C,
For Lead and Iron Pipe.

†FOR LEAD AND IRON PIPE—2090-C.

Size, Inches.	Weight Per Dozen, Lbs.	Finished.		Nickel-Plated.	
		Code.	Per Dozen.	Code.	Per Dozen.
1/2	12	Pulpiting.....	\$21.00	Pulpitorum.....	\$23.00
3/4	15	Pulpitista.....	32.00	Pulpo.....	34.50

One-half dozen in a box.

†Carried in San Francisco only.

In Orders and Specifications give Plate Numbers and Sizes.

LEVER STOPS.

GROUND KEY. CAST HANDLES. NUT AND WASHER.

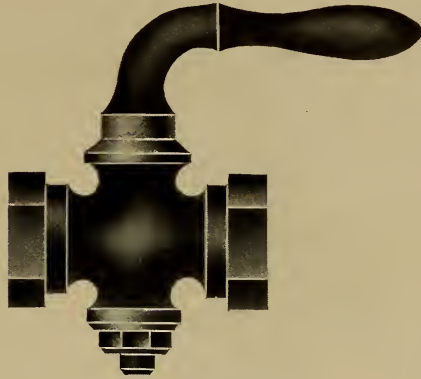

2091-C.
For Iron Pipe.

FOR IRON PIPE—2091-C.

Size, Inches.	Weight Per Dozen, Lbs.	Rough.		Finished.		Nickel-Plated.	
		Code.	Per Dozen.	Code.	Per Dozen.	Code.	Per Dozen.
3/8	6 1/2	Pulpolique.....	† \$15.00	Pultabant.....	† \$18.50	Pultifago.....	† \$20.00
1/2	10	Pulseless.....	† 17.00	Pultaceous.....	21.00	Pultifagus.....	23.00
5/8 x 3/4	14	Pulsific.....	22.00	Pultarium.....	† 27.00	Pultificos.....	29.50
3/4	16 1/2	Pulsiloge.....	† 26.00	Pultenee.....	32.00	Pultiphage.....	† 34.50
1	24	Pulsimeter.....	† 38.00	Pultibus.....	Pultium.....
1 1/4	36	Pulsiones.....	† 60.00	Pulticula.....	Pultlampe.....
1 1/2	48	Pulsuram.....	† 90.00	Pulticulis.....	Pultsitz.....

One-half dozen in a box.

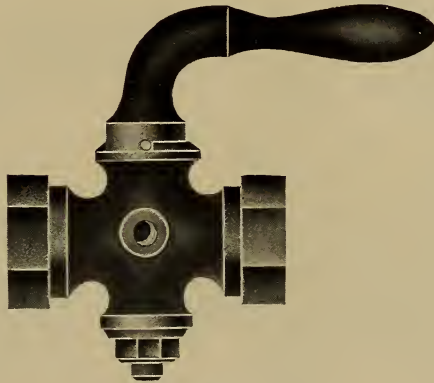

† **2092-C.**
For Iron Pipe with Waste.

† **FOR IRON PIPE WITH WASTE—2092-C.**

Size, Inches.	Weight Per Dozen, Lbs.	Rough.		Finished.		Nickel-Plated.	
		Code.	Per Dozen.	Code.	Per Dozen.	Code.	Per Dozen.
3/8	8 1/2	Pululaba.....	\$17.00	Pulver.....	\$20.50	Pulverholz.....	\$22.00
1/2	11	Pululamos.....	19.00	Pulverable....	23.00	Pulverhorn.....	25.00
5/8 x 3/4	13 1/2	Pululando.....	24.00	Pulverdamp....	29.00	Pulverig.....	31.50
3/4	18	Pulularon.....	28.00	Pulverfass.....	34.00	Pulverino.....	36.50
1	25 1/2	Pululeis.....	41.00	Pulvergang....	Pulverise.....	53.00

One-half dozen in a box.

† Carried in San Francisco only.

In Orders and Specifications give Plate Numbers and Sizes.

LEVER SHOWER STOPS.

GROUND KEY. ROUGH BODY WITH FLANGE AND HANDLE.

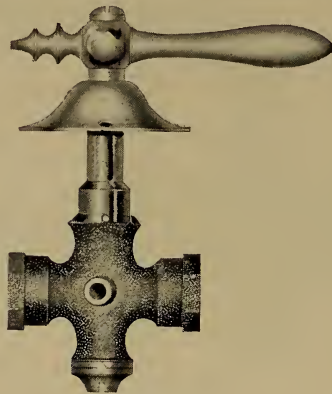

†2095-C.

FOR IRON PIPE WITH WASTE.

Size, Inches.	Weight Per Dozen, Lbs.	Finished Flange and Handle.		Nickel-Plated Flange and Handle.	
		Code.	Per Dozen.	Code.	Per Dozen.
1/2	19	Pulversack	\$26.00	Pulversieb	\$28.50
3/4	26	Pulversatz	38.00	Pulvesces	41.00

“MONARCH” COMBINATION STOP AND WASTE.

GROUND KEY. NUT AND WASHER. RIGHT OR LEFT HAND WITH INTERCHANGEABLE HANDLE.
MADE OF RED METAL. GUARANTEED TIGHT. TESTED 250 POUNDS PRESSURE.

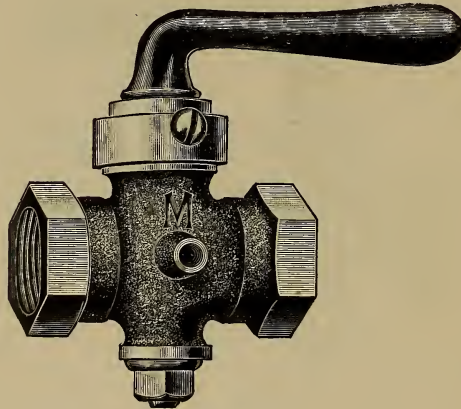

2096-C.

FLAT WAY FOR IRON PIPE WITH WASTE.

Rough Tee Handle.				Rough Lever Handle.			
Code.....	Pulvicles	Pulvifere	Pulvilled	Code.....	Pulvillo	Pulvinatum	Pulvinorum
Size, inches	1/2	†3/8 x 3/4	3/4	Size, inches.....	†1/2	†3/8 x 3/4	†3/4
Per dozen.....	\$19.00	24.00	28.00	Per Dozen	\$19.00	24.00	28.00
Weight per doz., lbs.	15	17 1/2	21 1/2	Weight per doz., lbs.	15	18	22 1/2

One-half dozen in a box.

†Carried in San Francisco only.

In Orders and Specifications give Plate Numbers and Sizes.

TEE HANDLE STOPS.

GROUND KEY. NUT AND WASHER.

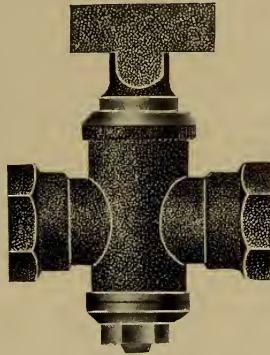

†2101-C.

ROUGH FLATWAY FOR IRON PIPE WITH STOP AND WASTE.

Code.....	Pulzelle	Pulzone	Pumaradas
Size, inches.....	1/2	3/4	1
Per dozen.....	\$19.00	28.00	41.00
Weight per dozen, lbs.....	11	16	23

One-half dozen in a package.

“H” PATTERN TEE HANDLE STOPS.

GROUND KEY. NUT AND WASHER.

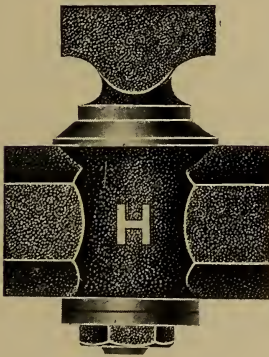

†2102-C.

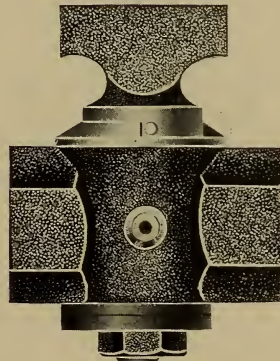

†2103-C.

ROUGH ROUNDWAY FOR IRON PIPE.

ROUGH ROUNDWAY FOR IRON PIPE WITH WASTE.

Code.....	Pumicabar	Pumicabunt
Size, inches.....	1/2	3/4
Per dozen.....	\$18.00	26.50
Weight per dozen, lbs.....	12	18

Code.....	Pumicamus	Pumicate
Size, inches.....	1/2	3/4
Per dozen.....	\$20.00	28.50
Weight per dozen, lbs.....	12	18

One-half dozen in a box.

†Carried in San Francisco only.

In Orders and Specifications give Plate Numbers and Sizes.

BRASS GAS SERVICE COCKS.

STANDARD.

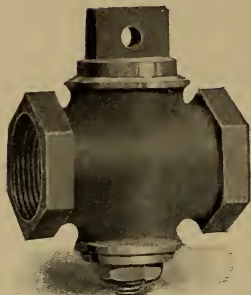

2110-C.
Flat Head.

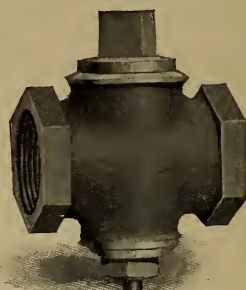

2111-C.
Square Head.

Code, Flat Head.....	Pumicose	Pummace	Pumpee	Pumpenro	Pumpensat	Pumphake
Code, Square Head.....	Punaisot	Puncante	Puncaao	Punchayot	Punchions	Puncta
Size, inches.....	$\frac{3}{8}$	$\frac{1}{4}$	$\frac{3}{8}$	$\frac{1}{2}$	$\frac{3}{4}$	1
Each.....	\$0.75	.75	.85	.95	1.15	1.50
Weight each, lbs.....	$\frac{3}{8}$	$\frac{1}{2}$	$\frac{3}{8}$	1	$1\frac{3}{4}$
Code, Flat Head.....	Pumphose	Pumpkin	Pumpsatt	Pumpwerk	Punados	
Code, Square Head.....	Punctiform	Punctilio	Punctillis	Punctio	Punctoar	
Size, inches.....	1 $\frac{1}{4}$	1 $\frac{1}{2}$	2	2 $\frac{1}{2}$	3	
Each.....	\$2.25	3.10	5.00	11.00	16.00	
Weight each, lbs.....	$2\frac{1}{2}$	$2\frac{7}{8}$	$5\frac{3}{4}$	$9\frac{1}{8}$	$14\frac{3}{4}$	

Square Head Service Cocks will be sent unless otherwise specified.

BRASS STEAM SERVICE COCKS.

STANDARD.



2112-C.
Flat Head.



2113-C.
Square Head.

Code, Flat Head.....	Puncturos	Pundib	Pundonor	Punendeli	Punetazos	Pungamos	Pungebat
Code, Square Head.....	Pungisteis	Pungled	Pungolassi	Pungolato	Punhado	Punhetes	Punian
Size, inches.....	$\frac{3}{8}$	$\frac{1}{4}$	$\frac{3}{8}$	$\frac{1}{2}$	$\frac{3}{4}$	1	1 $\frac{1}{4}$
Each.....	\$0.85	.85	1.00	1.25	1.70	2.35	3.70
Weight each, lbs.....
Code, Flat Head.....	Pungently	Pungetto	Pungidor	Pungimos	Pungir	Pungiran	
Code, Square Head.....	Punibile	Punicanos	Punidora	Punigione	Puniness	Punirian	
Size, inches.....	1 $\frac{1}{2}$	2	2 $\frac{1}{2}$	3	3 $\frac{1}{2}$	4	
Each.....	\$4.85	7.30	14.50	22.50	38.50	50.00	
Weight each, lbs.....	2	

Square Head Service Cocks will be sent unless otherwise ordered.

†Carried in San Francisco only.

In Orders and Specifications give Plate Numbers and Sizes.

BRASS STEAM SERVICE COCKS.

EXTRA HEAVY.

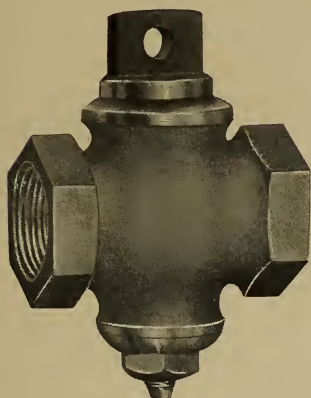

†2118-C.
Flat Head.

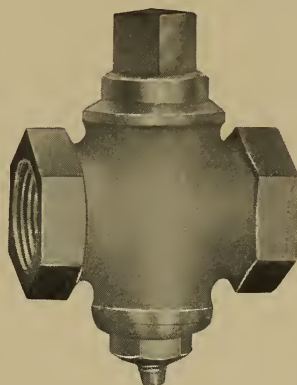

†2119-C.
Square Head.

Code, Flat Head.....	Punitivo	Punitoris	Punivano	Punivimus	Punjum	Punkabs
Code, Square Head.....	Puntadores	Puntaglia	Puntal	Puntapie	Puntarla	Puntboor
Size, inches.....	¼	⅜	½	¾	1	1¼
Each	\$1.30	1.50	2.00	2.85	4.00	6.75
Weight each, lbs
Code, Flat Head.....	Punktum	Punorum	Punschglas	Punschlied	Punster	Puntachtig
Code, Square Head.....	Puntdeur	Puntdicht	Punteggia	Puntellano	Puntellare	Punteloos
Size, inches.....	1½	2	2½	3	3½	4
Each	\$8.50	13.50	25.00	37.00	54.00	75.00
Weight each, lbs

Square Head Service Cocks will be sent unless otherwise ordered.

IRON SERVICE COCKS.

ALL IRON. STANDARD. SCREWED.

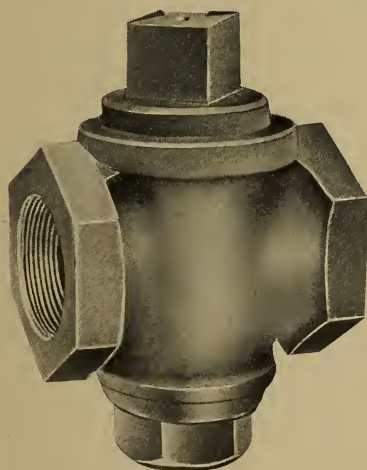

†2120-C.

Code.....	Punterola	Punthaak	Punthaken	Punthoed	Puntiamola
Inches.....	½	¾	1	1¼	1½
Each	\$0.90	1.05	1.30	1.60	1.95
Weight each, lbs...
Code.....	Puntiglio	Puntillazo	Puntillero	Puntolino	Puntosas
Inches.....	2	2½	3	3½	4
Each	\$2.70	4.40	6.75	12.00	15.50
Weight each, lbs...

The illustration sets forth quite clearly improvements made in Standard Iron Cocks wherein added strength, an opening full area of pipe, and, on account of the large plug and body, an increased bearing affording a tight seal under excessive pressures, are obtained.

†Carried in San Francisco only.

In Orders and Specifications give Plate Numbers and Sizes.

CHABOT COCKS.

BRASS. FLAT HEAD.

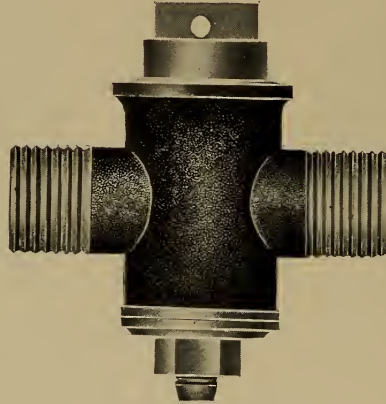

†2127-C.

SCREWED OUTSIDE FOR IRON PIPE.

Code	Puntrede	Puntuadas	Puntuale	Puntualizo	Puntuamos	Puntuaron
Size, inches	½	¾	1	1¼	1½	2
Per dozen.....	\$16.20	28.80	46.20	93.60	124.80	208.80
Weight per dozen, lbs						

Loose.

JEFFRESS' COCKS.

BRASS. FLAT HEAD. WITH STOP AND WASTE.

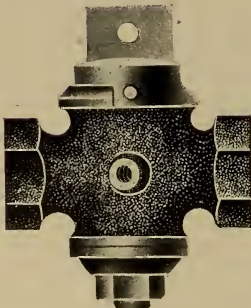

†2128-C.

Code.....	Punturetta	Puntuto
Size, inches.....	½	¾
Per dozen	\$19.00	28.00
Weight per dozen, lbs.....	9	13½

Loose.

METER COCKS.

BRASS. FLAT HEAD.

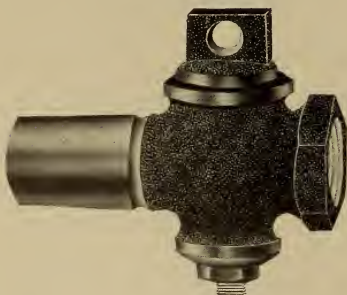

2129-C.

Code.....	Punzabamos	Punzadas
Size, inches.....	½	¾
Each.....	\$1.30	1.40
Weight each, lbs.....		

Loose.

†Carried in San Francisco only.

In Orders and Specifications give Plate Numbers and Sizes.

CORPORATION COCKS.

BRASS. ROUND FULL WAY. GROUND KEY. NUT AND WASHER.

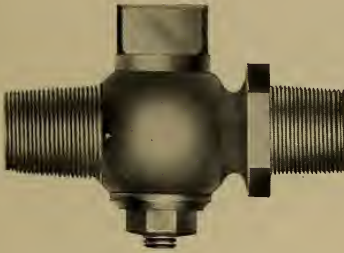

2135-C.

Standard Pattern.
Both Ends Threaded Outside for I. P.

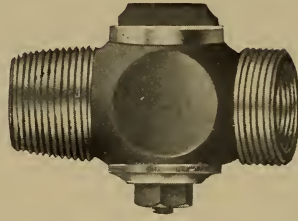

†**2136-C.**

For Mueller Tapping Machine.
For Male Screw Plug. No Couplings

STANDARD CORPORATION COCKS—2135-C.

Code.....	Punzadura	Punzaria	Punzecchia	Punzello	Punzione	Punzoneria
Size, inches.....	½	¾	1	1¼	1½	2
Per dozen.....	\$16.20	28.80	46.20	93.60	124.80	208.80
Weight per dozen, lbs.....	12	19	27

†**“MUELLER” CORPORATION COCKS—2136-C.**

Code.....	Punzones	Pupalies	Puparial
Size, inches.....	½	¾	1
Each.....	\$1.35	2.40	3.85
Weight each, lbs.....



†**2137-C.**

For Payne's Tapping Machine.
Male for Iron Pipe.



2137-C.

Showing Opposite End
of Payne's Corporation Cock.

PAYNE'S PATENT CORPORATION COCKS—2137-C.

Code.....	Puparzia	Pupilage	Pupilares	Pupillary	Pupillar
Size, inches.....	½	¾	1	1¼	1½
Per dozen.....	\$12.00	23.00	36.00	80.00	100.00
Weight per dozen, lbs.....	...	12

Any of above corporation cocks can be furnished with straight or bent couplings for lead pipe.
Prices upon application.

We can furnish Corporation Cocks for any make of tapping machine and any style desired.

† Carried in San Francisco only.

In Orders and Specifications give Plate Numbers and Sizes.

GARDEN HOSE VALVES.

BRASS.

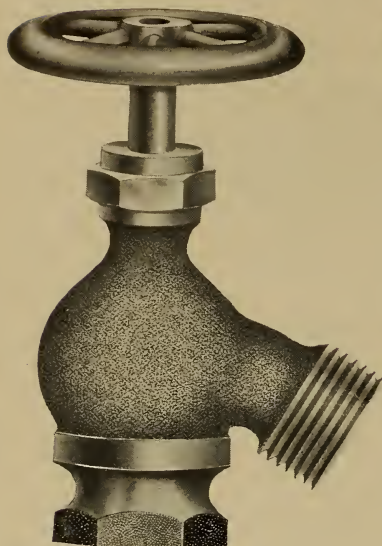

2144-C.
Bent.

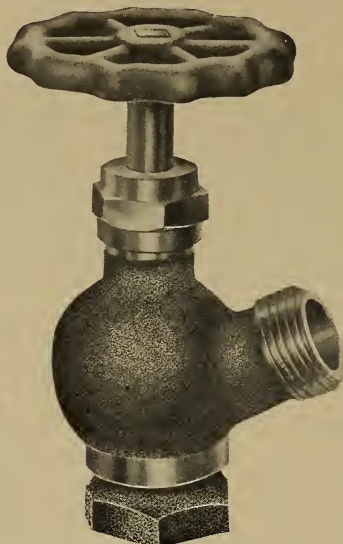

†2145-C.
Inverted.

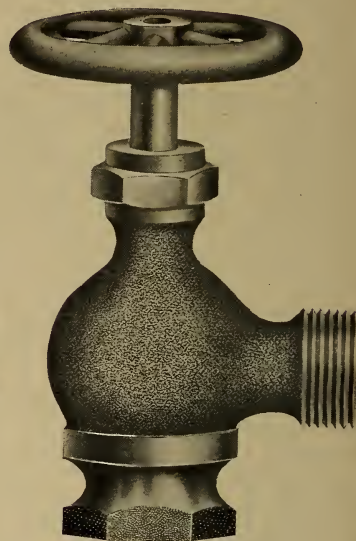

2146-C.
Straight.

BENT GARDEN VALVES—2144-C.

Code	Pupilles	Pupinos	Pupinium	Pupionner	Pupipare	Pupitres	Pupivore
Size, inches.....	½	¾	1	1¼	1½	2	2½
Each	\$1.65	1.65	2.20	3.40	4.75	7.00	12.00
Weight each, lbs	1	1¼	1½	2¾	4¼	6	11

INVERTED GARDEN VALVES—2145-C.

Code.....	Pupiwaste
Size, inch.....	¾
Each	\$1.65
Weight each, lbs.....	1¼

†STRAIGHT GARDEN VALVES—2146-C.

Code	Puposa	Puppenhaft	Puppenkopf	Puppenkram	Puppentand	Puppetish
Size, inches.....	½	¾	1	1¼	1½	2
Each.....	\$1.65	1.65	2.20	3.40	4.75	7.00
Weight each, lbs.....	1	1¼	1¾	3	4½	6

½ to 1-inch, 6 in a package ; other sizes loose.

These Valves have standard iron pipe thread on bottom, and are made with California hose thread on side.

†Carried in San Francisco only.

In Orders and Specifications give Plate Numbers and Sizes.

COMPRESSION SILL COCKS.

ANGLE PATTERN.

**2149-C.**WHEEL HANDLE. FEMALE IRON PIPE THREAD AND $\frac{3}{4}$ -INCH HOSE THREAD.

Size, Inches.	Weight Per Dozen, Lbs.	Rough Nickel-Plated.		Finished.		Nickel-Plated.	
		Code.	Per Dozen.	Code.	Per Dozen.	Code.	Per Dozen.
$\frac{1}{2}$	17	Puppetman	\$25.00	Pupugero	\$28.00	Pupulant.....	\$31.00
$\frac{3}{4}$	21	Puppyism	25.00	Pupugimus.....	28.00	Pupulum	31.00

One-half dozen in a box.

**2150-C.**LOOSE KEY. FEMALE IRON PIPE THREAD AND $\frac{3}{4}$ -INCH HOSE THREAD.

Size, Inches.	Weight Per Dozen, Lbs.	Rough Nickel-Plated.		Finished.		Nickel-Plated.	
		Code.	Per Dozen.	Code.	Per Dozen.	Code.	Per Dozen.
$\frac{1}{2}$	15	Puramente	\$28.00	Puraques.....	\$31.00	Purblind	\$34.00
$\frac{3}{4}$	19	Puranic	28.00	Puravero.....	31.00	Purcon	34.00

One-half dozen in a box.

One Key furnished with each Loose Key Pattern Cock.

In Orders and Specifications give Plate Numbers and Sizes.

STEAM METAL VALVES.

STANDARD. BRASS.



2160-C.

Globe Valve.



2161-C.

Angle Valve.

GLOBE VALVES—2160-C.

Code.....	Purefactos	Purefactum	Purezza	Purflewed	Purfing	Purgaban
Size, inches.....	1/8	1/4	3/8	1/2	3/4	1
Each.....	\$0.72	.72	.77	1.00	1.26	1.80
Weight each, lbs.....	3/8	5/8	3/4	1	1 1/2	2
Code.....	Purgabile	Purgabunt	Purgador	Purgamina	Purgarem	Purgarono
Size, inches.....	1 1/4	1 1/2	2	† 2 1/2	† 3	† 4
Each.....	\$2.52	3.50	5.30	10.00	14.40	36.00
Weight each, lbs.....	3 1/4	4	6	10	17

1/8 to 3/4-inch, 6 in a package; 1-inch, 4 in a package; other sizes loose.

ANGLE VALVES—2161-C.

Code.....	Purgativos	Purgatos	Purgatrice	Purgavamo	Purgement
Size, inches.....	1/8	1/4	3/8	† 1/2 x 3/8	1/2
Each.....	\$0.72	.72	.77	1.00	1.00
Weight each, lbs.....	5/8	3/4	7/8	1
Code.....	Purgeoir	Purghero	Purghetto	Purgitabo	Purgonal
Size, inches.....	3/4	1	1 1/4	1 1/2	2
Each.....	\$1.26	1.80	2.52	3.50	5.30
Weight each, lbs.....	1 1/2	2	3 1/4	4	6

1/4 to 3/4-inch, 6 in a package; 1-inch, 4 in a package; other sizes loose.

† Carried in San Francisco only.

In Orders and Specifications give Plate Numbers and Sizes.

STEAM METAL VALVES.

STANDARD. BRASS.



2165-C.

Globe Valve.
Finished Brass Wheel.
Nickel-Plated all over.



†2166-C.

Globe Valve.
Cross Handle.
Nickel-Plated all over.



2167-C.

Angle Valve.
Iron Wheel.
Rough Nickel-Plated.



2168-C.

Angle Valve.
Cross Handle.
Nickel-Plated all over.

IRON WHEEL GLOBE VALVE, ROUGH NICKEL-PLATED—2165-C.

Code.....	Puridade	Purifasse	Purificado	Puriferas
Size, inches.....	$\frac{3}{8}$	$\frac{1}{2}$	$\frac{3}{4}$	†1
Each.....	\$1.00	1.25	1.70	2.20
Weight each, lbs.....	$\frac{3}{4}$	1	1½	2

†BRASS WHEEL GLOBE VALVES, FINISHED AND NICKEL-PLATED ALL OVER—2165-C.

Code.....	Purifiques	Puriforme	Purigaret
Size, inches.....	$\frac{3}{8}$	$\frac{1}{2}$	$\frac{3}{4}$
Each.....	\$2.40	2.65	3.20
Weight each, lbs.....	$\frac{3}{4}$	1	1½

CROSS HANDLE GLOBE VALVES, FINISHED AND NICKEL-PLATED ALL OVER—2166-C.

Code.....	Purimfest	Purimorum	Purimos
Size, inches.....	$\frac{3}{8}$	$\frac{1}{2}$	$\frac{3}{4}$
Each.....	\$2.40	2.65	3.20
Weight each, lbs.....	$\frac{3}{4}$	1	1½

IRON WHEEL ANGLE VALVE, ROUGH NICKEL-PLATED—2167-C.

Code.....	Purisima	Purismus	Puristic	Puritain	Puritanic
Size, inches.....	$\frac{3}{8}$	$\frac{1}{2} \times \frac{3}{8}$	$\frac{1}{2}$	† $\frac{3}{4}$	†1
Each.....	\$1.00	1.25	1.25	1.70	2.20
Weight each, lbs.....	$\frac{3}{4}$	$\frac{3}{4}$	1	1½	2

CROSS HANDLE ANGLE VALVES, FINISHED AND NICKEL-PLATED ALL OVER—2168-C.

Code.....	Puritanism	Puritanize	Purlicue	Purline
Size, inches.....	$\frac{3}{8}$	† $\frac{1}{2} \times \frac{3}{8}$	$\frac{1}{2}$	$\frac{3}{4}$
Each.....	\$2.40	2.65	2.65	3.20
Weight each, lbs.....	$\frac{3}{4}$	$\frac{3}{4}$	1	1½

All on this page, six in a package.

†Carried in San Francisco only.

In Orders and Specifications give Plate Numbers and Sizes.

GAS LOG VALVES.

BRASS WITH FINISHED AND NICKEL-PLATED HANDLES AND STEMS.



† 2173-C.



† 2174-C.

GAS LOG GLOBE VALVES.

Code.....	Purloined
Size, inch	½
Each.....	\$2.80
Weight each, lbs.....	1¼

GAS LOG ANGLE VALVES.

Code.....	Purpart
Size, inch.....	½
Each.....	\$2.80
Weight each, lbs.....	1¼

The stems on above valves measure 1⅞-inch in the clear.

† Carried in San Francisco only.

In Orders and Specifications give Plate Numbers.

STEAM METAL VALVES.

WITH JENKINS' DISC. BRASS.



2179-C.
Globe Valve.



† **2180-C.**
Angle Valve.



† **2181-C.**
Globe Valve. Jenkins Bros.'
Genuine.

† GLOBE VALVES WITH JENKINS' DISC—2179-C.

Code.....	Purpling	Purplish	Purpoint	Purported	Purposeful	Purposive	Purpurace	Purpurados
Size, inches.....	¼	⅜	½	¾	1	1¼	1½	2
Each.....	\$1.10	1.25	1.60	2.20	2.80	4.00	5.50	8.75
Weight each, lbs.....	⅝	⅞	1	1¼	2¼	4¾	6½	10½

† ANGLE VALVES WITH JENKINS' DISC—2180-C.

Code.....	Purpuramos	Purpurasco	Purpurblut
Size, inches.....	½	¾	1
Each.....	\$1.60	2.20	2.80
Weight each, lbs.....	1¾	1½	2½

† JENKINS BROS.' GENUINE GLOBE VALVES—2181-C.

Code.....	Purpurear	Purpureo	Purpurhell	Purpurholz	Purpurico	Purpurique	Purpurisso	Purpurizar	Purpurkop
Size, inches.....	¼	⅜	½	¾	1	1¼	1½	2	2½
Each.....	\$1.10	1.25	1.60	2.20	2.80	4.00	5.50	8.75	15.75
Weight each, lbs.	⅞	1	1½	2¾	3½	5¼	6¾	11	17½

¼ to ¾-inch, 6 in a package; 1 to 1½-inch, 2 in a package; other sizes loose.

† JENKINS' DISCS FOR VALVES.

Code.....	Purpurlack	Purpurope	Purpurroth	Purpursaft	Purrock	Purseful	Pursiness	Pursive	Purslane
Size, inches.....	¼	⅜	½	¾	1	1¼	1½	2	2½
Each.....	\$0.03	.04	.04	.05	.06	.09	.12	.18	.24

† Carried in San Francisco only.

In Orders and Specifications give Plate Numbers and Sizes.

STEAM METAL CHECK VALVES.

BRASS.

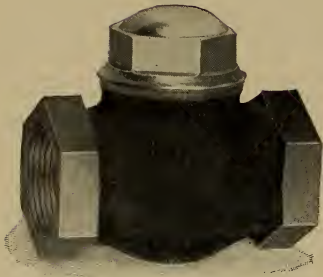

2187-C.
Horizontal.



2188-C.
Vertical.



†2189-C.
Horizontal.
Jenkins' Disc.

HORIZONTAL CHECK VALVES—2187-C.

Code	Pursuable	Pursual	Pursuing	Purtenance	Purulence	Purulentos	Purveyors	Purview	Pusarum	Puscinos
Size, inches.....	¼	⅜	½	¾	1	1¼	1½	2	†2½	†3
Each	\$0.65	.70	.90	1.15	1.60	2.25	3.15	4.75	9.00	13.00
Weight each, lbs.	¼	⅜	½	¾	1¼	2½	2¾	4¼	8	14

VERTICAL CHECK VALVES—2188-C.

Code.....	Puscinum	Puseyism	Puseyistic	Puseyite	Pushpin	Pushtoo	Pusieron
Size, inches.....	⅜	½	¾	1	1¼	1½	2
Each.....	\$0.77	1.00	1.26	1.80	2.52	3.50	5.30
Weight each, lbs.....	⅜	½	¾	1¼	1¼	2¾	4⅞

†HORIZONTAL CHECK VALVES WITH JENKINS' DISC—2189-C.

Code.....	Pusignando	Pusillorum	Pussulam	Pussulis	Pustawolf	Pustoloso
Size, inches.....	½	¾	1	1¼	1½	2
Each.....	\$1.30	1.90	2.60	3.60	5.00	7.50
Weight each, lbs.....	⅞	1¾	2	3⅞	4¾	8

¼ to 1-inch, 6 in a package; 1¼-inch, 3 in a package; other sizes loose.

† Carried in San Francisco only.

In Orders and Specifications give Plate Numbers and Sizes.

“DETROIT” RADIATOR VALVES.

IMPROVED QUICK-OPENING. FOR HOT WATER. CAN BE PACKED WITHOUT DRAWING THE WATER.



2195-C.

“Detroit” Quick-Opening Hot Water Radiator Valve, with Wood Wheel and Male Union. made from Steam Metal; threaded Right Hand on Union and Right Hand on Bottom.

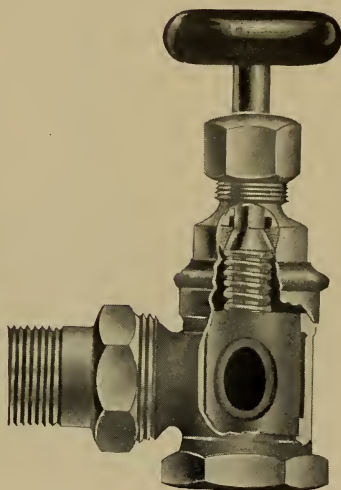

2196-C.

Sectional View.

One-quarter turn of the handle opens or closes the passage, an arrow on the top of the handle indicating the position of the valve. The openings are of full area, with no obstruction to the free passage of water.

Circulation is maintained at all times, thus obviating danger of freezing. The valve proper, or rotating disc, is practically a piston ring, and therefore readily adjusts itself to any variation in size, due to expansion and contraction.

The conical projection on stem at A forms a perfectly tight joint at this point, and allows the stem to be repacked without drawing off the water. Note also the recess at B, between valve body and circular disc. This passage prevents dirt or sediment from sticking between these parts and causing disc to bind.

Code.....	Pustulesco	Pustuletta	Pustulosas
Size, inches.....	$\frac{3}{4}$	1	1$\frac{1}{4}$
Rough Body Nickel-Plated all over, each.....	\$2.85	3.65	5.05
Weight each, lbs.....

†Carried in San Francisco only

In Orders and Specifications give Plate Numbers and Sizes

RADIATOR VALVES.

STEAM MEAL. JENKINS' DISC.

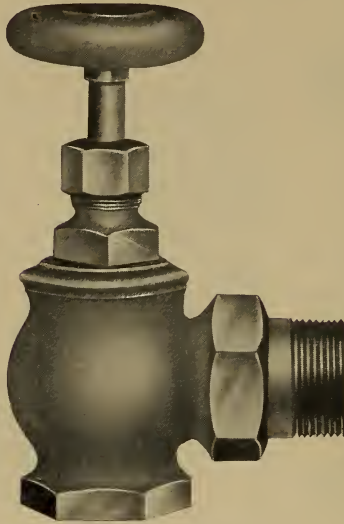

2200-C.

RADIATOR VALVE WITH JENKINS' DISC, WOOD WHEEL AND MALE UNION, THREADED RIGHT HAND ON UNION AND RIGHT HAND ON BOTTOM.

Code	Pusulati	Putamus	Putaretis	Putatifs	Putativa
Size, inches	$\frac{3}{4}$	1	1$\frac{1}{4}$	1$\frac{1}{2}$	2
Rough body, nickel-plated all over.....	\$3.80	4.75	6.40	8.10	13.10
Weight each, lbs.....	3 $\frac{1}{2}$	5

UNION RADIATOR ELBOWS.

FOR UNION RADIATOR VALVES.

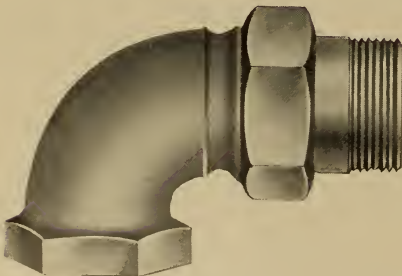

2201-C.

Code	Putativum	Putatorem	Putavimus
Size, inches	$\frac{3}{4}$	1	1$\frac{1}{4}$
Rough body, nickel-plated all over	\$2.00	2.50	3.20
Weight each, lbs.....	$\frac{3}{4}$	1 $\frac{1}{4}$	1 $\frac{3}{4}$

Code.....	Putbaas	Putboor
Size, inches.....	1$\frac{1}{2}$	2
Rough body, nickel-plated all over.....	\$4.00	7.00
Weight each, lbs.	2 $\frac{1}{4}$

Both threads right hand.

In Orders and Specifications give Plate Numbers and Sizes.

HOSE FIRE VALVE.

WHARF HYDRANT.

BRASS. ROUGH BODY. FINISHED TRIMMINGS.

IRON BODY. BRASS MOUNTED.

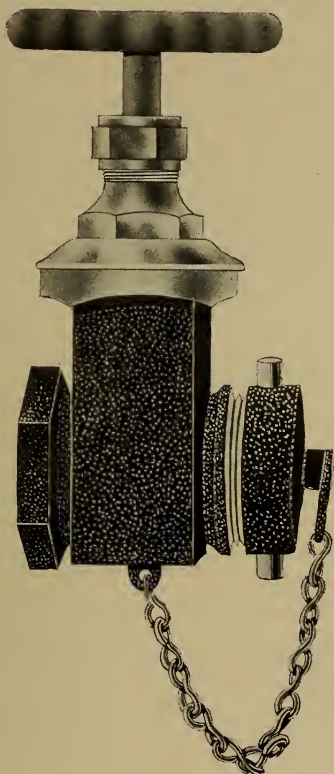

†2205-C.

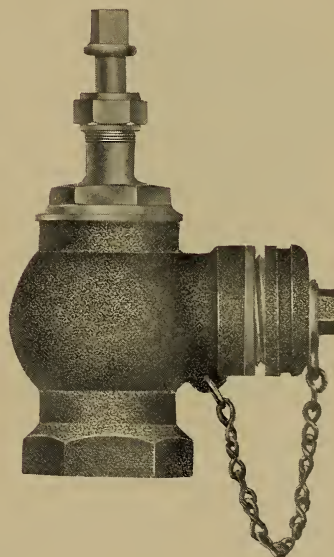

†2206-C.

†HOSE FIRE VALVES WITH CAP AND CHAIN—2205-C.

Code.....	Putchock	Putdelyer	Putefacta	Puterhahn
Size, inches.....	1¼	1½	2	2½
Each.....	\$4.85	6.50	9.25	16.50
Weight each, lbs.....	9	16¼

†HOSE FIRE VALVES WITHOUT CAP AND CHAIN.

Code.....	Putgalg	Putgraver	Puticules	Putidorum
Size, inches.....	1¼	1½	2	2½
Each.....	\$3.50	5.00	7.50	14.00
Weight each, lbs.....	8¼	14½

These Valves have iron pipe thread on the bottom and 2½-inch Standard Pacific Coast Hose Thread on side. They have a non-rising stem and loose revolving discs. No grinding between face of valve and discs.

†WHARF HYDRANT WITH CAP AND CHAIN—2206-C.

Code.....	Putolente	Putorem
Size, inches.....	2½	3
Each.....	\$15.00	16.00
Weight each, lbs.....	21

These Hydrants have iron pipe thread on the bottom and 2½-inch Standard Pacific Coast Hose Thread on side.

†Carried in San Francisco only.

In Orders and Specifications give Plate Numbers and Sizes.

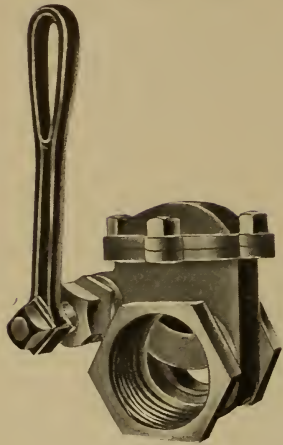

2210-C.

“READY” THROTTLE VALVES.

ALL BRASS. STEAM METAL. STANDARD.

Code.....	Putorias	Putoribus	Putramina	Putrabile	Putridame	Putridendo
Size, inches.....	½	¾	1	1¼	1½	2
Each.....	\$1.60	1.80	2.50	3.50	5.00	7.50
Weight each, lbs.	⅞	1¼	1¾	2½	4	6

These Valves are suitable for laundry machinery, railroad tanks, water motors, refineries, paper mills, breweries, tanneries, oil and gas works, or wherever a reliable quick action is required under moderate pressure.

STRAIGHTWAY U. S. GATE VALVES.

RISING STEM STEAM METAL. DOUBLE DISCS. STANDARD PRESSURE. SCREWED ENDS.

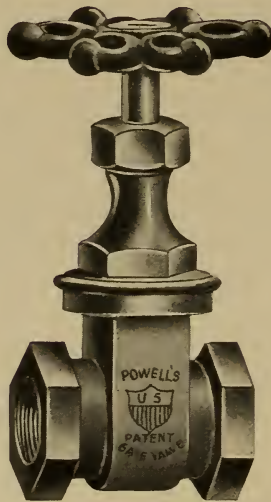

2213-C.

Code.....	Putridiva	Putridus	Putrificar	Putrilagem	Putrivores	Putruosi	Puttella	Puttina	Puttyer	Putwater
Size, inches.....	¼	⅜	½	¾	1	1¼	1½	2	2½	3
Each.....	\$1.25	1.25	1.30	1.75	2.50	3.50	5.00	7.50	14.00	20.00
Weight each, lbs.	⅝	¾	1	1½	2¾	3¾	6	8½	13	18

These Valves embody all the desirable features of a first-class valve of this character. Made of best Steam Metal, and are tested and warranted.

In Orders and Specifications give Plate Numbers and Sizes.

IRON BODY SCOTT STRAIGHTWAY GATE VALVES.

BRONZE MOUNTED. STANDARD WEIGHT. FOR STEAM WORKING PRESSURE OF 100 POUNDS. OPEN LEFT.



2218-C.

Screwed Ends with Packing Nut.

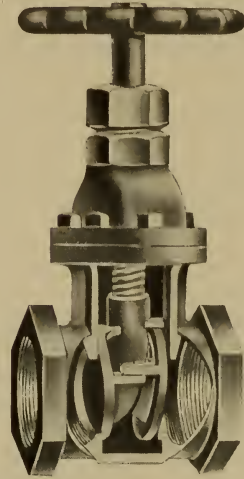

2219-C.

Showing Sectional View.

Code	Putzdame	Putzkasten	Putzladen	Putzladden	Putzmachen
Inches	2	2½	3	4	6
Each	\$10.00	12.00	15.00	20.00	30.00
Weight each, lbs.....	25	30	32½	53

DIMENSIONS.

Diameter of port, inches.....	2	2½	3	4	6
Face to face, inches	5¾	6¾	7¾	8¾	10½
Center of port to top of wheel, inches.....	8	10	10¾	13½	19¾
Diameter of wheel, inches	5	6	6¾	8½	11

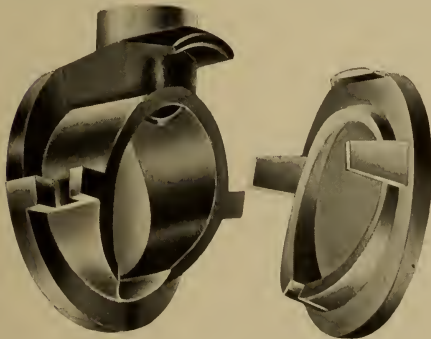

2220-C.

Scott's Patent Cylinder Wedge.

On account of the peculiar construction of the patent **cylinder wedge** and the **full circular bearing** upon the back of the disc or gate, the wear is taken from the face and seat, thus insuring a **perfect seating** and the impossibility of the discs springing, bending or getting out of shape. The discs are raised by their lugs coming in contact with corresponding shoulders on the wedge. By the peculiar arrangement of the lugs, the bearing of one disc slightly rotates upon the other, so that the least movement on the stem releases one disc slightly in advance of the other, thereby causing the valve to open easily under the heaviest pressures.

Please note that the Scott Gate Valve has no special **inlet** side, it can be connected in any way, horizontally, vertically or otherwise, with either side to the pressure, so no expensive mistakes can be made.

All stem threads are cut square. All parts are interchangeable and can be supplied upon short notice. Some of the best mechanical engineers claim that a solid disc in a valve does not allow for unequal expansion, consequently the disc expands more in one place than another, causing the valve to leak.

In Orders and Specifications give Plate Numbers and Sizes.

LUDLOW VALVES.

Ludlow Valves are made by the oldest established and largest Valve and Hydrant Manufacturers in the world, who make but one grade of goods—the best that can be produced, as to design, material and workmanship. We caution purchasers against imitations. All genuine Ludlow Valves are made exclusively by the Ludlow Valve Manufacturing Co., and have the word “Ludlow” cast or stamped upon them.

We are prepared to furnish estimates for Valves of any size and for any service, and shall be pleased to mail special catalogue of Ludlow Valves on application.

Fig. 70.

A—Case.

B—Cover or Bonnet.

C—Stem or Spindle.

D—Packing Plate or Stuffing Box.

E—Stuffing Box Gland or Follower.

F—Stem Nut.

GG—Gates.

H—Gate Rings.

I—Case Rings.

J—Top Wedge.

K—Bottom Wedge.

L—Throat Flange Bolts.

M—Stuffing Box or Follower Bolts.

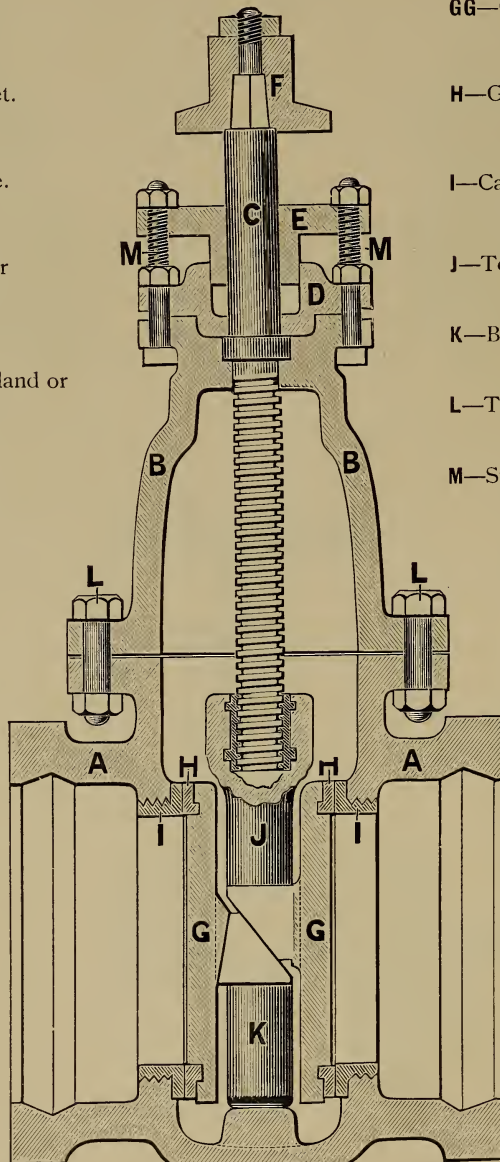

†2230-C.

LUDLOW BRONZE-MOUNTED DOUBLE GATE VALVE WITH BOLTED STUFFING BOX.
 When ordering stems for repairs state whether wanted with single or double thread.
 †Carried in San Francisco only.

In Orders and Specifications give Plate Numbers and Sizes.

LUDLOW DOUBLE GATE STRAIGHTWAY VALVES.

Ludlow Valves are constructed on scientific principles.

The metal used, both iron and bronze, is of the highest grade.

The workmanship is unsurpassed.

The construction of the gates and wedges, and method of wedging, is such that there is

No locking or wedging of gates in closing until they are directly opposite port or valve opening.

No grinding or dragging faces of gates on seats in either locking or unlocking gates.

No binding of stem in wedge.

No stripping thread from stems, by gates canting to either side in closing and wedging.

There is less wear on the faces of gates and seats in opening and closing than on valves of any other make.

They work equally well with pressure either side of gate, and, without exception, they last longer and give better satisfaction than valves of other makes, and their record proves the assertion.

Fig. 84.

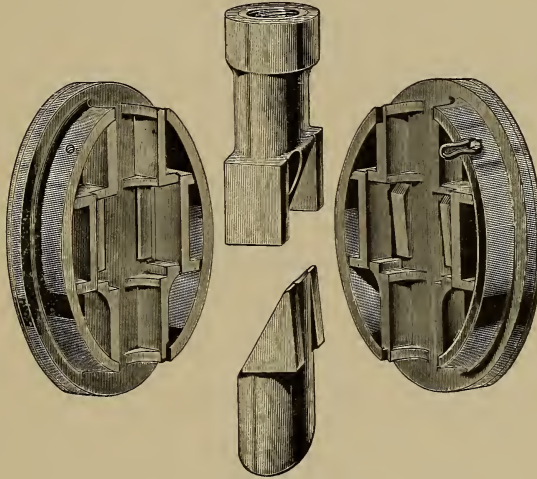

2231-C.

Style of Gates and Wedges for Double Gate Valves.

METHOD OF OPENING, CLOSING AND WEDGING OR LOCKING GATES.

The internal mechanism of Valve consists of the stem, two gates, and two bevel-faced wedges, the wedges being entirely independent of the gates (or discs) and working between them.

Closing and Wedging.—By the action of the stem, which works through the nut in the upper wedge, the gates descend parallel with their seats until the lower wedge strikes the stop (or boss) in the bottom of case—the gates and upper wedge continuing their downward movement until the face or bevel of upper wedge comes in contact with face or bevel of lower wedge. The gates then being down opposite port or valve opening, the face of the upper wedge moves across the face of the lower wedge, bringing pressure to bear on the backs of both gates, **from central bearings**, thus forcing them apart and squarely against their seats.

Opening.—In opening Valve, the first turn of the stem releases the upper wedge from contact with the lower wedge, thereby instantly releasing both gates (or discs) from their seats **before they commence to rise.** This is not possible in any other make of valve.

There is less wear on the faces of gates and seats in opening and closing, as there is not the grinding which must necessarily follow in valves of other makes in drawing one or both gates off their seats before obtaining any relief.

The nut through which the stem (or spindle) works forms part of the upper wedge, which has center bearings, and there is therefore no possibility of the gates being canted to either side in closing and wedging, thereby binding or stripping thread from stem, as is the case in other makes, where the nut is independent and rests loosely in extreme top of gates.

Our method of wedging or locking gates, and construction of wedges, as now applied, was adopted only after years of test and experience, and is superior to anything yet put on the market, and Ludlow Valves will work easier under any pressure and with less wear than those of any other make.

All our Double Gate Valves work equally well **with the pressure either side of gate.**

The superiority of Ludlow Valves, and their method of operating, is attested by the fact that there are more of them made and sold than any other make of valve, and the majority of our competitors making paralleled faced valves imitate them as far as they possibly can without infringing our patents.

In Orders and Specifications give Plate Numbers and Sizes.

DIRECTIONS FOR ORDERING.

TO ENABLE US TO FILL ORDERS PROMPTLY AND CORRECTLY, IT IS NECESSARY THAT THE FOLLOWING INFORMATION BE GIVEN:

Size.

Number of List (1, 4, 6,7, etc.)

Whether Bronze Mounted or All Iron.

Whether Screwed, Flanged, Hub, or Spigot Ends.

Whether to turn to the right to open



or whether to turn to the Left to open.



Number of pounds pressure or head under which Valves are to work.

Whether to be used for steam, water, gas, etc.

If with Gearing.

Whether with Spur Gearing or with Bevel Gearing.

If with By-Pass.

The size of By-pass desired.

Unless otherwise ordered, all Hub and Spigot Valves will have Nut on Spindle (or Stem) for wrench. All others will have Hand Wheel.

If not to stand upright, state whether Valve is to lie on edge or on its flat side. (A Valve placed in a vertical pipe lies on its flat side.)

Valves without gearing will be sent with Inside Screw, unless otherwise specified.

When ordering Flanged Valves, please note changes in diameters of End Flanges, Lists Nos. 1, 4 and 6, which now conform to schedule of Standard Flanges adopted July 18, 1894, by Master Steam and Hot Water Fitters' Association and American Society of Mechanical Engineers, and at Manufacturers' meeting, June 28, 1901.

When ordering Flanged End Valves with the end Flanges drilled, if not to be drilled to our templet, give diameter of bolt circle, size and number of holes, and state whether stem (or center) line passes through the top bolt hole (Fig. 1), or between two top bolt holes (Fig. 2).



Fig. 1.



Fig. 2.

In Orders and Specifications give Plate Numbers and Sizes.

LIST No. 7. BRONZE VALVES, DOUBLE GATE.

Tested { 6 inches and under at 300 lbs. pressure } per square inch, water pressure.
 { 7 inches and above at 250 lbs. pressure } Test guaranteed.

FOR STEAM OR WATER. OPEN LEFT.

These Valves are strictly first-class, both as to material and workmanship. The metal used is equal to that called for in government work, and both as to tensile and transverse strength is superior to that used in any other make of valve.

For finish and durability they are unsurpassed. They are made to bear a heavy working pressure.

They work equally well with the pressure either side of gate.

The gates and seats have ground faces, thus insuring steam-tight and water-tight joints. The gates have parallel faces and the method of closing and wedging is such that there is less wear on the faces of gates and seats than on any other make of valve.

For method of closing and wedging gates, see page 547.

All sizes up to six inches have the screwed stuffing-box and follower-nut, unless otherwise ordered.

All sizes above six inches have the bolted packing gland and follower.

We can also furnish Valves of all sizes and for all pressures of either deoxidized or phosphor bronze. Prices given upon application.

Fig. 85.



† 2233-C.

Screwed Ends.

With Screwed Cover and Rising Stem.

Style of Sizes, 3/8, 1/2, 3/4 and 1 Inch.

Fig. 86.

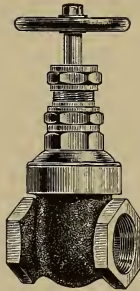

† 2234-C.

Screwed Ends.

With Screwed Cover and Screwed Stuffing-Box.

Style of Sizes, 1 1/4, 1 1/2 and 2 Inches.

Fig. 87.

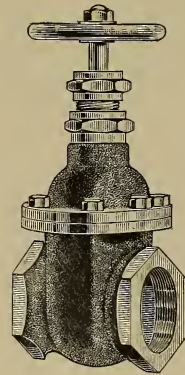

† 2235-C.

Screwed Ends.

With Bolted Cover and Screwed Stuffing-Box.

Style of Sizes, 2 1/2 to 6 Inches, Inclusive.

Code	Pyanepsia	Pyanisies	Pycme	Pycnidia	Pyenite	Pycnitidis
Size, inches	3/8	1/2	3/4	1	1 1/4	1 1/2
Face to face of screwed ends, inches.....	2 1/4	2 1/4	2 1/2	2 7/8	3 3/8	3 3/4
Screwed ends, each.....	\$1.40	1.40	1.80	2.35	3.40	4.40
For slide stem and lever, add to list.....	\$0.80	.80	.80	.80	1.00	1.00
Weight each, lbs.....	1 1/4	1 1/2	2 1/2	3 1/4	4 3/4	5 1/2
Code	Pynocarpe	Pynocomis	Pyncycle	Pynodes	Pyncodis	
Size, inches.	2	2 1/2	3	3 1/2	4	
Face to face of screwed ends, inches.....	4 1/8	4 3/16	5	5 5/8	6 1/4	
Screwed ends, each.....	\$6.25	13.75	15.50	23.50	34.00	
For slide stem and lever, add to list.....	\$1.25	1.75	2.00	2.00	2.00	
Weight each, lbs.....	9 1/4	15 1/2	19	30	44 1/2	

Sizes 3/8, 1/2, 3/4 and 1-inch of our regular Screw Stem Bronze Valves have rising stem; all other sizes have non-rising stem. We, however, will furnish these sizes, if so ordered, with non-rising stem at a slightly increased cost over the rising stem valves. Unless otherwise specified, we will continue sending these sizes with rising stem.

Valves with removable gate and seat rings furnished if desired. Prices given upon application.

† Carried in San Francisco only.

In Orders and Specifications give Plate Numbers and Sizes.

LIST NO. 4. DOUBLE GATE VALVES.

IRON BODY WITH BRONZE MOUNTINGS, AND ALL IRON. FOR WATER, STEAM, GAS, OIL, AMMONIA ETC. BRONZE MOUNTED, FLANGED, SCREWED, HUB OR SPIGOT ENDS.

Tested at 300 pounds pressure per square inch, water pressure. Test guaranteed. For heavy working pressures either side of gate. These Valves are constructed on scientific principles. For method of construction, see page 546.

Fig. 96.

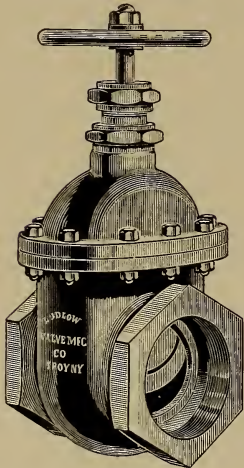

† 2236-C.

Screwed End Valve.
With Bronze Screwed Packing Box and Follower Nut.
Style of sizes up to and including 6 inches.

Fig. 97.

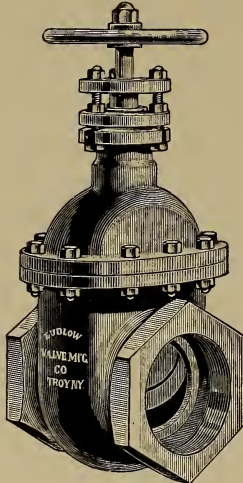

† 2237-C.

Screwed End Valve.
With Bolted Packing Plate and Follower.
Style of sizes above 6 inches.

Fig. 98.

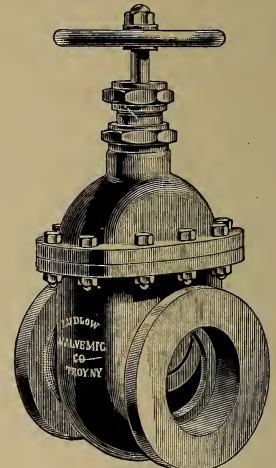

† 2238-C.

Flanged End Valve.
With Bronze Screwed Packing Box and Follower Nut.
Style of sizes up to and including 6 inches.

Fig. 11.

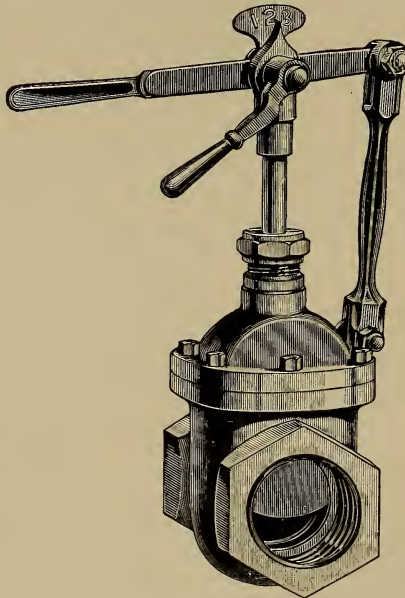

† 2240-C.

Showing style of Sliding Stem and Lever. For either Screwed or Flanged End Valves.

Fig. 3.

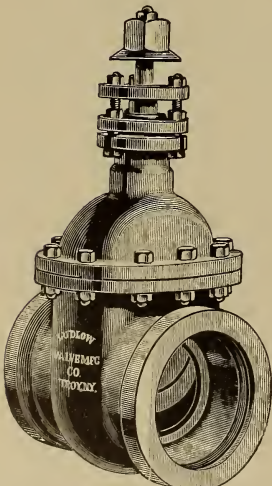

† 2239-C.

Hub or Bell End Water or Gas Valve.
Style of all sizes.

† Carried in San Francisco only.

Fig. 5.



† 2241-C.

Flanged End Valve. With Bolted Packing Plate and Follower. Style of sizes above 6 in.

Write for Special Catalogue.

In Orders and Specifications give Plate Numbers and Sizes.

†LIST NO. 4. DOUBLE GATE VALVES.

IRON BODY WITH BRONZE MOUNTINGS.

Screwed and Flanged Ends open left. Hub or Bell Ends open right.

Tested at 300 pounds pressure per square inch, water pressure. Test guaranteed.

For Heavy Working Pressures Either Side of Gate.

Size, inches.....	1½	2	2½	3	3½	4	
Code.....	Pycnomon	Pycnosore	Pycnostyle	Pycnotique	Pyctam	Pydna	
Screwed Ends, each.....	\$6.00	7.00	10.25	12.25	16.50	18.00	
Weight each, lbs.....	8	14	22½	29½	55	62	
Code.....	Pygela	Pygmea	Pygmies	Pygomele	Pygopage	Pygopodes	
Flanged Ends, each.....	\$6.25	7.50	10.75	13.25	17.50	18.50	
Weight each, lbs.....	14	23	32	43	69½	76	
Code.....		Pylenor	Pyleus	Pyloride	Pymatus	Pyoning	
Hub or Bell Ends, each.....		7.00	10.00	14.50	16.00	17.00	
Weight each, lbs.....		25	38	67		80	
Code.....				Pyrrhico		Pyrrhonia	
Screwed Ends for Casing, each.....				\$12.25		18.00	
Weight each, lbs.....				29½		62	
For Slide Stem and Lever, add to list.....	\$1.00	1.25	1.75	2.00	2.00	2.00	
For Outside Screw and Yoke, add to list.....	\$.....			8.50	9.25	10.00	
Size, inches.....	4½	5	6	7	8	10	12
Code.....	Pyeli	Pygarg	Pygargum	Pygastres	Pygathrix	Pygaulas	Pygedium
Screwed Ends, each.....	\$23.00	25.00	30.50	38.00	45.00	64.00	82.50
Weight each, lbs.....	103	130	160	210	239	391	530
Code.....	Pygopus	Pygoscele	Pygure	Pyjama	Pylada	Pylagoras	Pylartes
Flanged Ends, each.....	\$23.50	25.50	31.00	38.00	43.50	64.50	80.00
Weight each, lbs.....	111	131	166	220	236	406	513
Code.....	Pyoplanie	Pyragres	Pyralida	Pyrame	Pyramide	Pyrgite	Pyrgomes
Hub or Bell Ends, each.....	\$22.00	24.00	28.00	37.00	42.00	60.00	76.00
Weight each, lbs.....		142	180	208	244	384	490
Code.....		Pyrrhoses	Pyrrhule				
Screwed Ends for Casing, each.....		\$25.00	30.50				
Weight each, lbs.....		130	160				
For Slide Stem and Lever, add to list.....	\$2.25	2.25	2.25	2.25	2.25	3.25	4.00
For Outside Screw and Yoke, add to list.....	\$11.00	12.00	14.00	16.00	18.00	23.00	27.00

Dimensions—Inches.

Size, inches.....	1½	2	2½	3	3½	4	4½	5	6	7	8	10	12
Face to Face of Screwed Ends.....	4	4⅞	5⅜	5½	7¼	7¼	9½	11	11¼	12	12⅞	13⅝	13⅝
Face to Face of Flanges.....	5½	5⅝	6⅞	6⅞	8¼	8¼	9¾	10¾	11⅞	11¼	11	13¾	14⅝
Diameter of Standard Flanges.....	5½	6	7	7½	8½	9	9¼	10	11	12½	13½	16	19
End to End of Hubs or Bells.....	7	7¾	8⅝	9⅜	9⅜	11	12	12½	13⅞	14⅞	14⅞	15	
Depth of Hubs or Bells.....	2¼	2¼	2½	2⅝	2¾	3¼	3½	3⅞	4	4	4	4	4

We can also furnish these Valves with one end Hub and other end Spigot, or any other combination of above styles, as desired.

See page 550 for Description and Cuts. See page 548 for Directions for Ordering.

†Carried in San Francisco only.

In Orders and Specifications give Plate Numbers and Sizes.

LIST NO. 1. SINGLE GATE VALVES.

IRON BODY WITH BRONZE MOUNTINGS. OPEN LEFT.

Tested { 6 inches and under at 150 lbs. pressure } per square inch, water pressure.
 { 7 inches and over at 100 lbs. pressure } Test guaranteed.

For Medium Working Pressures.

SCREWED ENDS. FOR WATER, STEAM, GAS, ETC.

These Valves are intended for use in places where Double Gate Valves are not necessary or desirable, or where the pressure is not excessive. When used where the pressure is in but one direction they should be so placed that the pressure comes on the back of the gate.

The Iron-Bodied Valves have all bearings fully bronze mounted.

The seat ring is screwed in. The gate ring is dovetailed and riveted on. The stem is made of solid bronze.

Both the gate ring and seat ring have ground faces, thus making a steam-tight and water-tight joint.

These Valves have been manufactured for the past thirty years. They are giving perfect satisfaction, and we believe them to be the best Single Gate Valves made.

Fig. 96.

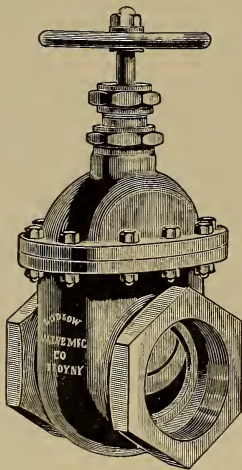

†2236-C.

Screwed End Valve.

With Bronze Screwed Packing Box and Follower Nut.

Style of sizes up to and including 6 inches.

Fig. 97.

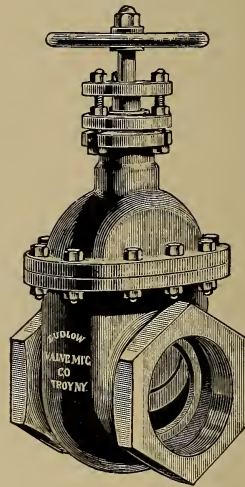

†2237-C.

Screwed End Valve.

With Bolted Packing Plate and Follower.

Style of sizes above 6 inches.

Code.....	Quabbe	Quabbeln	Quacha	Quackery	Quackler	Quader	Quaderno	Quaderputz	Quaderwerk
Sizes, inches.....	3	3½	4	5	6	7	8	10	12
Face to face of Screwed Ends, inches.....	5½	7¼	7¼	11	11¼	11⅝	12⅝	12⅝	13¼
Each.....	\$11.00	15.00	16.25	23.75	28.00	35.25	40.00	58.00	74.00
Weight each, lbs.....	29½	54	59	124	151	204	231	365

See page 548 for Directions for Ordering.

†Carried in San Francisco only.

In Orders and Specifications give Plate Numbers and Sizes.

LIST No. 6. DOUBLE GATE VALVES.

IRON BODY WITH BRONZE MOUNTINGS. FOR WATER, STEAM, GAS, ETC. TESTED AT 300 POUNDS PRESSURE PER SQUARE INCH, WATER PRESSURE. TEST GUARANTEED. FOR HEAVY WORKING PRESSURES EITHER SIDE OF GATE.

These Valves are intended for use in all places where Double Gate Valves are desired to work under heavy pressure.

The metal—both iron and bronze—is of the highest grade, and the workmanship is unsurpassed. They are constructed on scientific principles.

The bearings on the Iron-bodied Valves are fully bronze mounted.

The gates are adjustable, with center bearings, and cannot become stuck in the case.

The gates and seats have ground faces, thus insuring water-tight and steam-tight joints.

They work equally well with the pressure either side of gate.

For method of closing and wedging gates, see page 547.

A test of the tensile and transverse strength of the metal used—both iron and bronze—and a comparison with other valves as to the ease with which they can be opened and closed under pressure, will prove their superiority over any other in the market.

HUB OR SPIGOT ENDS, FOR WATER.

These Valves are superior to all other Water-Works Valves, for the reason that there is less wear on the face of the gates and seats in opening and closing, they work easier under heavy pressure, last longer, require fewer repairs, and give better general satisfaction, and their record proves the assertion.

There are more of these Valves in use in the water-works systems of the United States than of any other make.

FLANGED ENDS, FOR STEAM.

These Valves are arranged especially for steam, but work equally well for water.

The gearings and gear brackets on all Geared Valves are heavy and substantial.

By-passes of any size furnished as desired. Prices given upon application.

Fig. 107.

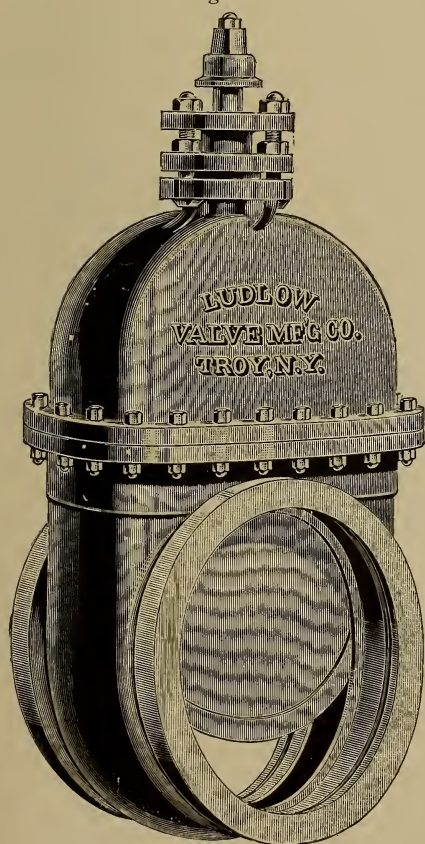

† 2245-C.

† Carried in San Francisco only.

DOUBLE GATE VALVE.

WITHOUT GEARING.

HUB OR BELL ENDS.

Made with either hub, flanged or spigot ends.

Made with either hand-wheel or nut for wrench.

Made with outside screw and yoke.

Made with or without by-pass.

Made for water or steam.

Made in any way desired.

Made to work equally well with pressure either side of gate.

Made for hard service.

Made to give satisfaction.

Prices for special designs given upon application.

For prices, see page 554.

See page 548 for Directions for Ordering.

In Orders and Specifications give Plate Numbers and Sizes.

† **LIST NO. 6. DOUBLE GATE VALVES.**

IRON BODY WITH BRONZE MOUNTINGS. OPEN LEFT.

Tested at 300 pounds pressure per square inch, water pressure. Test guaranteed. For Heavy Working Pressures Either Side of Gate.

Size, inches.....	14	15	16	17	18	20	22
Code.....	Quadrabile	Quadratura	Quadrage	Quadrammo	Quadramus	Quadrantal	Quadrassi
Flanged Ends, each.....	\$130.00	148.00	153.00	184.00	215.00	254.00	325.00
Weight each, lbs.....	770	890	963	1260	1650
Code.....	Quadraste	Quadratim	Quadratore	Quadrezza	Quadriceps	Quadricorn
Hub or Bell Ends, each.....	\$122.00	138.00	143.00	205.00	242.00	315.00
Weight each, lbs.....	705	820	875	1203	1585
Code.....	Quadrifido	Quadrifore	Quadriga	Quadrigato	Quadrigona
Spigot Ends, each.....	\$127.00	146.00	152.00	217.00	254.00
Weight each, lbs.....
For Spur Gearing add to list..	\$26.00	26.00	26.00	16.00	16.00	16.00	20.00
For Bevel Gearing add to list	28.00	28.00	28.00	18.00	18.00	18.00	24.50
Weight each, lbs.....	114	114	114	68	68

Dimensions, Inches.

Face to face of Flanges.....	15¾	15¾	16	17	17¾	20¼
Diam. of Standard Flanges..	21	22¼	23½	25	27½	29
End to end of Hubs or Bells..	15¾	15½	15¾	18	19½	19½
Depth of Hubs.....	4½	4	4½	5	5	5½

Size, inches.....	24	28	30	36	40	42	48
Code.....	Quadriloge	Quadrin	Quadrupear	Quadruplex	Quadruplo	Quadrussis	Quaeler
Flanged Ends, each.....	\$390.00	625.00	690.00	1060.00	1560.00	1670.00	2425.00
Weight each, lbs.....	2580	4260	8600	11650	18970
Code.....	Quaerunt	Quaesamur	Quaesivit	Quaestoren	Quaffed	Quaggy	Quagmire
Hub or Bell Ends, each.....	\$375.00	600.00	650.00	1020.00	1520.00	1630.00	2375.00
Weight each, lbs.....	2461	4425	8500	11500	12160	18550
Code.....	Quailing	Quaintly	Quakerish	Quakernest	Qualcosa	Qualcuno	Qualesso
Spigot Ends, each.....	\$390.00	625.00	660.00	1068.00	1590.00	1710.00	2500.00
Weight each, lbs.....
For Spur Gearing add to list	\$20.00	70.00	70.00	90.00	90.00	90.00	160.00
For Bevel Gearing add to list	24.50	95.00	95.00	125.00	125.00	125.00	200.00
Weight each, lbs.....	104	200

Dimensions, Inches.

Face to face of Flanges.....	21	26½	26½	28	34½	34½	42½
Diam. of Standard Flanges..	32	37	39	45	51	53	59
End to end of Hubs or Bells	22¼	24½	26	26¾	33	33	39
Depth of Hubs.....	6¼	6½	6¾	5¾	5½	5½	6¼

The above Valves can be furnished with By-pass, the price varying according to size and style of Valve.

The addition of a By-pass to a Valve usually lengthens the distance from face to face of Flanges, or from end to end of Hubs, the distance varying according to size of By-pass desired.

For Description and cut, see page 553. See page 548 for Directions for Ordering.

† Carried in San Francisco only.

In Orders and Specifications give Plate Numbers and Sizes.

†LIST NO. 75. LUDLOW FIRE HYDRANTS.

BRONZE MOUNTED.

RUBBER FACED GATES.

DESCRIPTION AND METHOD OF OPERATING.

The Ludlow Fire Hydrant is of the Gate type, and its construction was undertaken with the view of meeting the demand for a strictly first-class non-freezing Hydrant, strong in every part, simple in construction, and one that would give a practically unobstructed flow of water, perform its work easily and satisfactorily under all sorts and conditions of soil and weather, produce no water hammer in closing, remain tight under all pressures, with a positive drip that would drain hydrant barrel completely, and so arranged that all the working parts could be taken out without doing any digging or disturbing the hydrant barrel, and judging from the number of cities and towns now using them (they being now in use in over 1800 different places), the thousands annually sold and the numerous testimonials received regarding its merits, we feel justified in claiming it has no equal in the market.

CLOSING AND OPENING HYDRANT GATE AND DRIP VALVE.

In closing, the gate is moved downward by the action of the stem through the threaded bronze wedge nut in the back of gate until it strikes the stop at the bottom of the projection in the back of hydrant (see cut page 557), when by the action of the bronze wedge nut, moving along the incline on the back of gate, it is forced squarely against its seat without any grinding movement on either the rubber gasket with which gate is faced or on the bronze seat ring, against which it closes, the projection at the top and bottom of gate keeping the rubber gasket away from the seat ring until it is forced squarely against it by the action of the wedge nut.

The final turn of the stem, after the gate is closed and wedged, opens the drip valve.

In opening Hydrant, the first turn of the stem closes the drip valve, after which the bronze wedge nut in back of gate is loosened, thus relieving the gate from its seat.

When the gate is fully opened, the face of the gate lies directly against the front of hydrant barrel, and is thus protected from injury by any foreign substance passing through the hydrant.

Drip Valve.—The Drip Valve, which is of bronze, faced with rubber, is screwed to lower end of hydrant stem, and works in a bronze cup set in the extreme bottom of hydrant.

It is adjustable and will always seat properly.

It is positive in its action.

It allows hydrant barrel to drain completely, leaving no water standing in it to freeze.

It opens only after the gate is closed and wedged.

It closes before the gate is released from its seat or any water enters barrel of hydrant.

It cannot become clogged, as it never leaves the Drip cup, and revolves with every movement of the stem.

There is no wear or grinding on the Rubber with which it is faced, as the lower part ceases to move as soon as Valve comes to its seat, the upper part only continuing to revolve with stem until the Gate is forced to its seat.

The best Hydrant Drip Valve made.

Where Hydrants are placed in wet ground and water enters the stand pipe or barrel, we have a simple arrangement for keeping the Drip Valve closed, which can be easily attached without shutting off the pressure and without digging.

Rubber.—Both the Gate and Drip Valve are faced with heavy solid special rubber gaskets, which we believe are far superior to either leather or metal for this purpose.

An experience of over 30 years with Rubber-faced Hydrants has proved that the elasticity of our special quality of rubber is not appreciably lessened by use or time. Profiting by our experience, several of our competitors, formerly using leather have lately adopted Rubber-faced Valves.

Bronze Mountings.—All the bearings are fully bronze mounted, the mountings consisting of the following parts: Seat Ring, Drip Cup, Drip Valve, lower or threaded section of Stem, Wedge Nut, Plate holding Rubber Gasket in Gate, Beveled Nut in back of Gate, Sleeve fitting on top of Stem and Nozzle.

See page 557 for cuts and Directions for Ordering. See page 558 for Prices.

†Carried in San Francisco only.

In Orders and Specifications give Plate Numbers and Sizes.

Fig. 130.

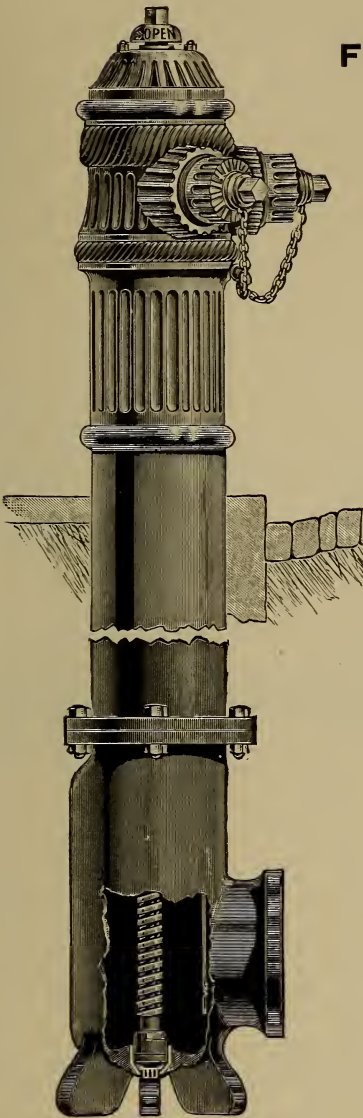

2255-C.

With bottom cut away, showing Gate open, and Drip Valve, which is in the extreme bottom of Hydrant, closed.

Fig. 131.

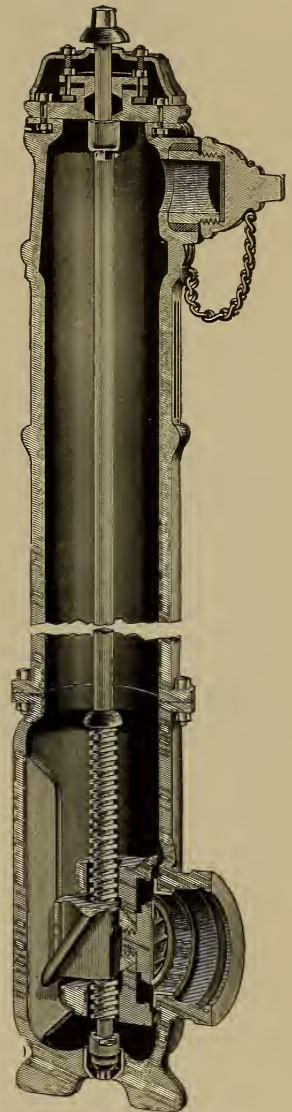

2256-C.

Sectional cut, showing Gate closed and locked, and Drip Valve, in extreme bottom of Hydrant, open.

DIRECTIONS FOR ORDERING.

- 1st. Give size of Valve Opening or inside diameter of Stand Pipe.
 - 2d. Give length from surface of ground to bottom of Connecting Pipe.
 - 3d. Give size of bottom Connecting Pipe. Regular Hydrants have Hub or Bell Ends. If wanted with Flange or Screwed Ends, so state.
 - 4th. Give number and size of Nozzles.
 - 5th. Give exact diameter of Nozzle Threads at top and bottom and number of Threads to the inch, or send either a Nozzle Cap, a Hose Coupling or a sample Nozzle for sizer.
 - 6th. Give size and style of Nut for Wrench—whether square or five-sided (or otherwise), length on side, and whether straight or taper.
 - 7th. State whether to open by turning to the left or to the right.
- See page 558 for prices and page 556 for Description.
Send for special catalogue Fire Hydrants.

In Orders and Specifications give Plate Numbers and Sizes.

†LIST NO. 75. LUDLOW FIRE HYDRANTS.

BRONZE MOUNTED. RUBBER-FACED GATE.

Tested at 300 pounds pressure per square inch, water pressure. Test guaranteed.

Prices are based on a length of five feet from surface of ground to bottom of connecting pipe.

Diameter of Seat Ring or Valve Opening.	Inside Diameter of Stand Pipe or Hydrant Barrel.	Hub End Bottom Connection Size of Connecting Pipe.	One 2-inch Nozzle.	One 2½-inch Nozzle.	Two 2½-inch Nozzles.	Three 2½-inch Nozzles.	Four 2½-inch Nozzles.	Six 2½-inch Nozzles.	One Steamer Nozzle.	One Steamer and One 2½-inch Nozzle.	One Steamer and Two 2½-inch Nozzles.	One Steamer and Three 2½-inch Nozzles.
Inches.	Inches.	Inches.										
2	3	2	\$17.00									
3	4 5/8	3 or 4		\$28.00								
4	5 3/4	3 or 4		31.00	\$33.00				\$33.00	\$35.00		
4	5 3/4	6		31.50	33.50				33.50	35.50		
4 1/2	6 1/4	6			35.50	\$37.50			35.50	37.50		
5	7	6			40.50	42.50	\$44.50		40.50	42.50		
6	8	6			50.00	52.00	54.00		50.00	52.00		\$46.50
6	8	8			51.25	53.25	55.25		51.25	53.25		56.00
8	10	8 or 10						\$130.00				57.25

Diameter of Seat Ring or Valve Opening.	One Steamer and Four 2½-inch Nozzles.	Two Steamer Nozzles.	For Each 6 Inches increase or decrease in length, add or deduct from list.	2½-inch Independent Nozzle Gate, each.	4-inch Independent Nozzle Gate, each.	Secondary Gate with Valve Box.	Outer Jackets or Frost Cases with the Ludlow Hydrant are entirely unnecessary, and therefore a useless expense. For those desiring Frost Cases, however, we quote list prices as follows :	Frost Case for 5-foot or Standard Length Hydrants.	For each 6 inches increase or decrease in length, add or deduct from list.
Inches.									
2			\$0.45			\$ 9.25			
3			.60			12.50		\$ 4.50	\$0.44
4			.75	\$3.50		12.50		5.00	.50
4			.75	3.50		12.50		5.00	.50
4 1/2			.80	3.50		15.50		5.60	.58
5			.85	3.75		15.50		6.50	.70
6	\$58.00	\$54.00	1.00	3.75	\$7.25	18.50		7.50	.90
6	59.25	55.25	1.00	3.75	7.25	19.50		7.50	.90
8			2.25	4.50		27.00		11.00	1.30

The size of Secondary Gate Valves, as quoted above, corresponds to size of Seat Ring or Valve Opening of Hydrant.

See page 556 for Description, and page 557 for Cuts and Directions for Ordering.

†Carried in San Francisco only.

In Orders and Specifications give Plate Numbers and Sizes.

RELIABLE WATER PRESSURE REGULATOR.

BRASS.

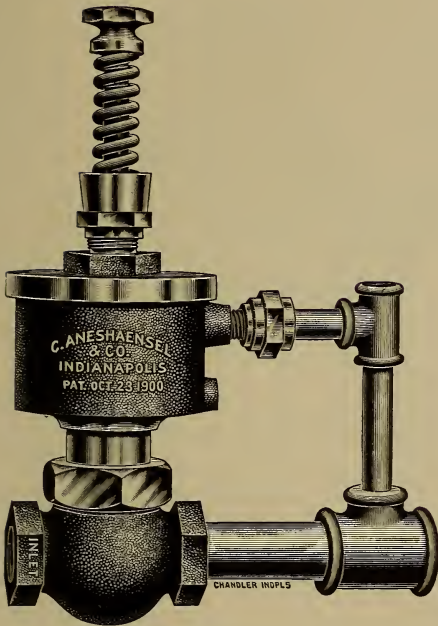

2260-C.

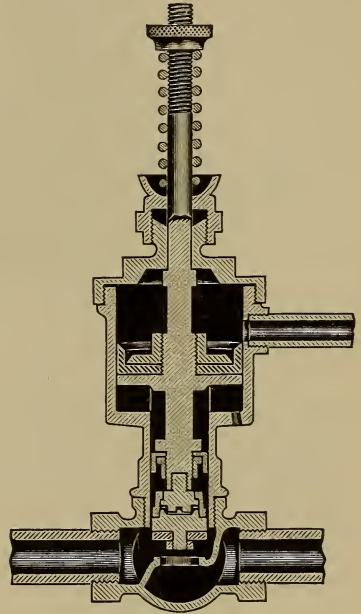

2261-C.

Sectional View of Reliable Water Pressure Regulator.

Code.....	Qualify	Qualle	Qualm	Qualort	Qualvall
Size, inches.....	1/2	3/4	1	1 1/4	1 1/2
Each	\$5.60	5.60	7.15	13.10	17.65
Weight each, lbs.....

The Reliable Water Pressure Regulator on the service pipe will keep the pressure uniform, regardless of varying pressure in the city mains.

To be used where water pressure is high, or where pressure is increased suddenly for fire purposes.

Prevents hammering and bursting of pipes and rattling of faucets.

Prevents opening of spring faucets and float valves in closet flush tanks.

Avoids splashing and overflows.

A saving of water where meter rates exist.

Water companies can protect their pressure during fires when their house services are provided with this reducing valve.

Connect city water service pipe with end marked "Inlet."

Thoroughly flush out all pipes before connecting the Regulator to prevent dirt, grit, red lead, solder and iron chips from getting into the Regulator Valve.

In Orders and Specifications give Plate Numbers and Sizes.

HERSEY DISC WATER METERS.

THOROUGHLY ACCURATE AND ENTIRELY RELIABLE.

Exterior.

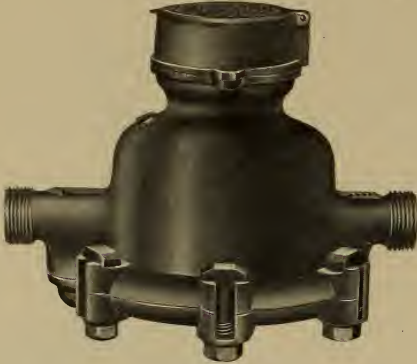

2270-C.

Interior.

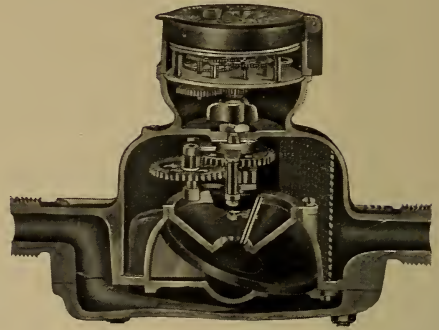

2271-C.

The Hersey Disc Meter is constructed of the very best non-corrosive materials. All screws, spindles and shafts are of phosphor bronze, and the piston of highest grade hard rubber, making the meter practically indestructible, all parts being interchangeable.

Each Meter is provided with a perforated strainer located in such a position as to exclude all foreign matter from the working parts.

The superior workmanship, quality of material and accuracy of registration have made this meter most popular.

Code.....	Quanto	Quandary	Quandel	Quando	Quantos	Quantulos	Quapalier	Quarkes
Size, inches.....	5/8	3/4	1	1 1/2	2	3	4	6
Each.....	\$8.00	12.00	16.00	30.00	50.00	90.00	175.00	375.00
Connections40	.60	.80	No Charge	No Charge	No Charge	No Charge	No Charge
Capacity per min., cu. ft..	2	4	8	12	20	36	72	120
“ “ “ gals...	15	30	60	90	150	270	540	900
Length, inches.....	7 3/8	9	10 7/8	12 5/8	15 1/4	24	29	36 1/2
Width, inches.....	5 1/2	7	8	11 1/8	12 1/8	18 1/8	22	27 3/4
Height, inches.....	6 1/4	7	7 1/4	8 1/4	11	16 3/8	19 3/4	25
Net weight, lbs.....	8	12	16	44	69	226	387	775
Gross weight, lbs.....	12	19	28	65	96	277	461	863

For economy in transportation, 5/8, 3/4 and 1-inch meters are packed five in a case when orders will permit. Such packages weigh 57, 87 and 115 lbs. respectively.

Hersey Disc Meters 5/8, 3/4 and 1-inch have Bronze Metal Cases; 1 1/2-inch and larger have Galvanized Iron Cases.

All 5/8, 3/4 and 1-inch Hersey Disc Meters are provided with male thread connections.

All 1 1/2 and 2-inch Hersey Disc Meters are provided with female thread connections. Galvanized iron unions or flange connections are provided when requested, without extra cost.

All 3, 4 and 6-inch Hersey Disc Meters are cast with flange connections. Corresponding flanges for wrought iron pipe or bell and spigot connections for cast iron pipe are furnished, when requested, without extra charge.

All Hersey Disc Meters from 5/8-inch to 2-inch inclusive are provided with inside Strainers.

All Hersey Disc Meters from 3-inch to 6-inch inclusive have no strainers.

All Hersey Disc Meters are provided with ordinary round registers adjusted to cubic feet, unless otherwise ordered, and are tested on the basis of 62.27 lbs. per cubic foot.

Hersey Disc Meters 5/8, 3/4 and 1-inch can be furnished with Galvanized Iron cases. Prices upon application.

In Orders and Specifications give Plate Numbers and Sizes.

NAMES AND NUMBERS OF HERSEY DISC METER PARTS.

MODEL F.

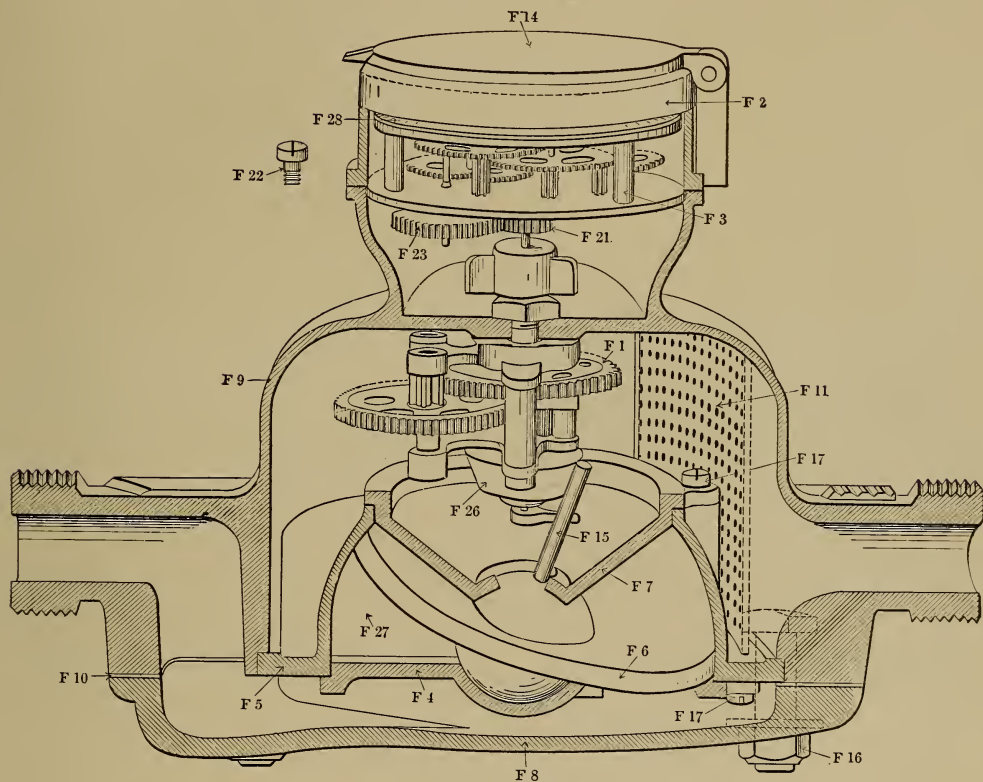

2272-C.

Code		Code	
Quartado.....	F 1 Intermediate Train.	Quarzfels	F 14 Lid.
Quartaine.....	F 2 Bonnet.	Quarzfluss	F 15 Piston Spindle.
Quartanos.....	F 3 Clock.	Quarzmehl	F 16 Flange Bolts.
Quartasse.....	F 4 Bottom Plate.	Quarzstein	F 17 Plate Screws.
Quartaut.....	F 5 Ring.	Quasimente.....	F 18 Bell Connection.
Quartel.....	F 6 Hard Rubber Disc.	Quasimodo.....	F 19 Flange Connection.
Quartelot.....	F 7 Top Plate.	Quassabar	F 20 Spigot Connection.
Quarterone.....	F 8 Bottom Case.	Quassabulo	F 21 Intermediate Train Gear.
Quartmass.....	F 9 Top Case.	Quassabunt	F 22 Bonnet Screws.
Quartprobe.....	F 10 Flange Packing.	Quassamus.....	F 23 Clock Gear.
Quarttridge.....	F 11 Strainer.	Quassandos.....	F 26 Hard Rubber Control.
Quartseite.....	F 12 Leather Washer.	Quassation	F 27 Abutment.
Quartzosa.....	F 13 Coupling.	Quassatura	F 28 Clock Dial.

All parts of Meters are made to interchange.

All Meters have a shop number which is stamped on the lid.

In ordering parts always give the shop number of the meter that the parts are wanted for, and also the name and number of the part.

In Orders and Specifications give Plate Numbers and Sizes.

NAMES AND NUMBERS OF HERSEY DISC METER PARTS.

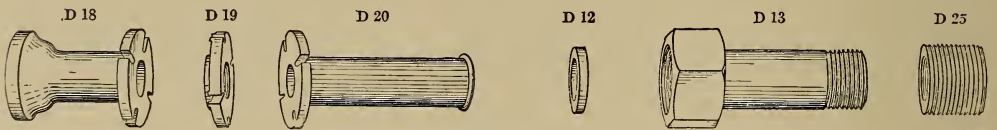
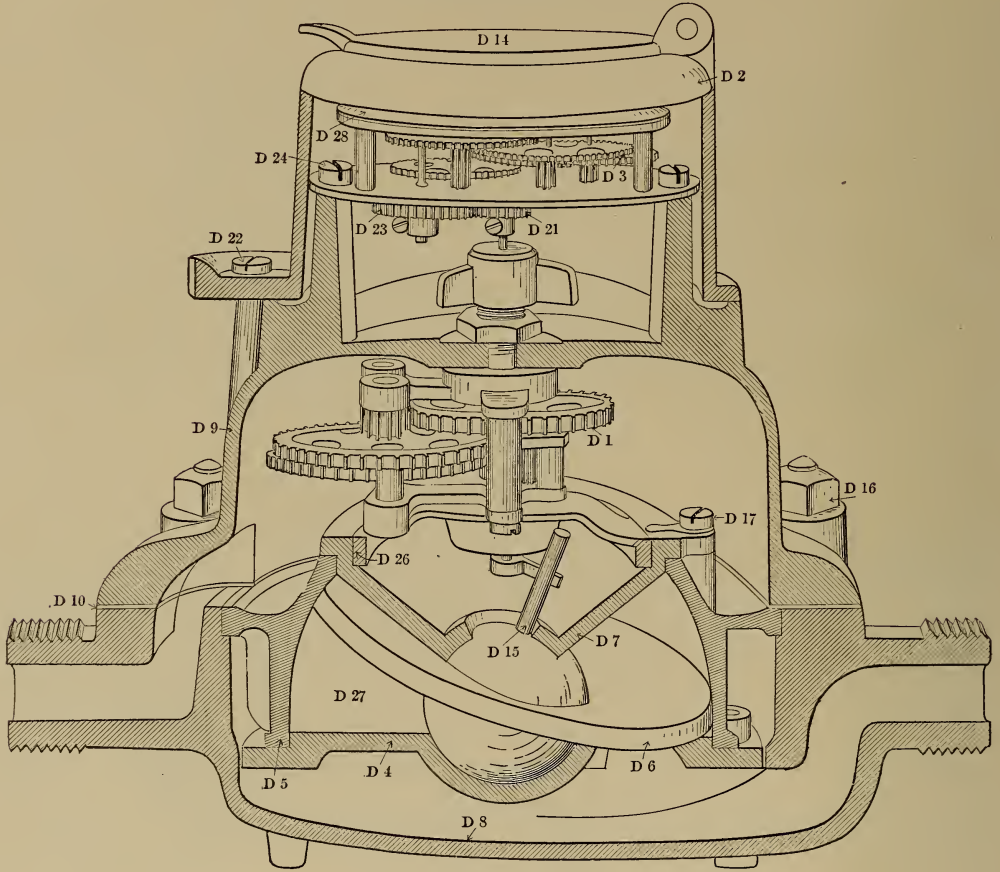

2273-C.

Code		
Quassier.....	D 1	Intermediate Train.
Quassorum	D 2	Bonnet.
Quatefacio.....	D 3	Clock.
Quatefacta	D 4	Bottom Plate.
Quateles	D 5	Ring.
Quatember	D 6	Hard Rubber Disc.
Quaternate	D 7	Top Plate.
Quatiunt	D 8	Bottom Case.
Quatorzain	D 9	Top Case.
Quatrain	D 10	Flange Packing.
Quatralvo	D 12	Leather Washer.
Quatriduo	D 13	Coupling.
Quatrim.....	D 14	Lid.
Quatrinca.....	D 15	Piston Spindle.

Code		
Quatschen.....	D 16	Flange Bolts.
Quatschige	D 17	Plate Screws.
Quavemire.....	D 18	Bell Connection.
Quaxabor	D 19	Flange Connection.
Quaxamur	D 20	Spigot Connection.
Quaxavisti.....	D 21	Intermediate Train Gear.
Quaxeris.....	D 22	Bonnet Screws.
Quayage	D 23	Clock Gear.
Queachy.....	D 24	Clock Screws.
Queasily.....	D 25	Nipple.
Queatur	D 26	Control.
Quebrable	D 27	Abutment.
Quebrador	D 28	Clock Dial.

All parts of Meters are made to interchange.

All Meters have a shop number, which is stamped on the lid.

In ordering parts always give the shop number of the Meter that the parts are wanted for, and also the name and number of the part.

In Orders and Specifications give Plate Numbers and Sizes.

NAMES AND NUMBERS OF HERSEY ROTARY METER PARTS.

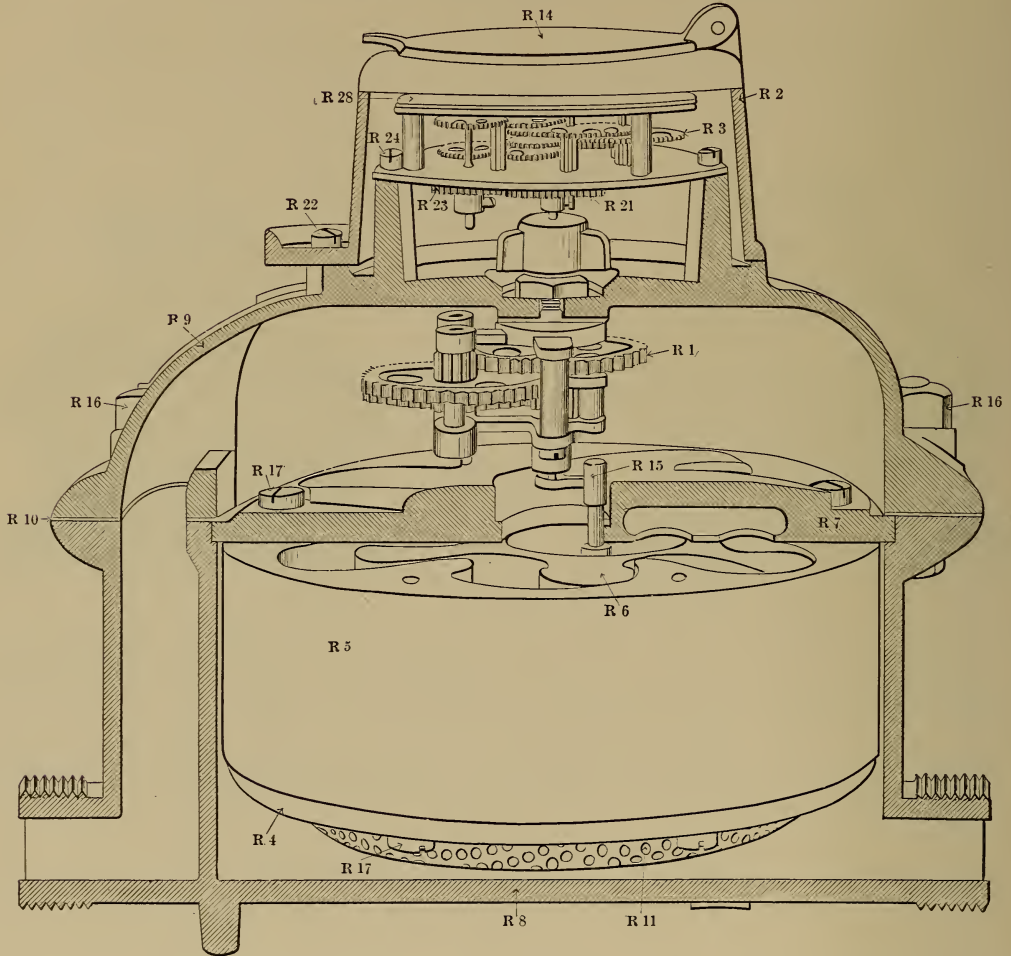

2276-C.

Code		Code	
Queenites	R 1	Quellader	R 14
Queenlike	R 2	Quellchen	R 15
Queenly ..	R 3	Quellgrund	R 16
Queenpost	R 4	Quellmoos	R 17
Queenship	R 5	Quellpunkt	R 18
Queerish	R 6	Quellreich	R 19
Queerity..	R 7	Quellsalz	R 20
Quehacer	R 8	Quellstock	R 21
Quejando	R 9	Quelques	R 22
Quejasen	R 10	Quemadero	R 23
Quejemos	R 11	Quemander	R 24
Quejicoso	R 12	Quemasas	R 25
Quejigal	R 13	Quemazon	R 28
		Quellader	R 14
		Quellchen	R 15
		Quellgrund	R 16
		Quellmoos	R 17
		Quellpunkt	R 18
		Quellreich	R 19
		Quellsalz	R 20
		Quellstock	R 21
		Quelques	R 22
		Quemadero	R 23
		Quemander	R 24
		Quemasas	R 25
		Quemazon	R 28
		Lid.	
		Piston Spindle.	
		Flange Bolts.	
		Plate Screws.	
		Bell Connection.	
		Flange Connection.	
		Spigot Connection.	
		Intermediate Train Gear.	
		Bonnet Screws.	
		Clock Gear.	
		Clock Screws.	
		Nipple.	
		Clock Dial.	

All parts of Meters are made to interchange.

All Meters have a shop number, which is stamped on the lid.

In ordering parts always give the shop number of the Meter that the parts are wanted for, and also the name and number of the part.

In Orders and Specifications give Plate Numbers and Sizes.

HERSEY TORRENT WATER METERS.

EXTERIOR

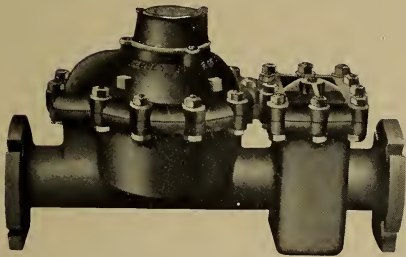

2279-C.

INTERIOR.

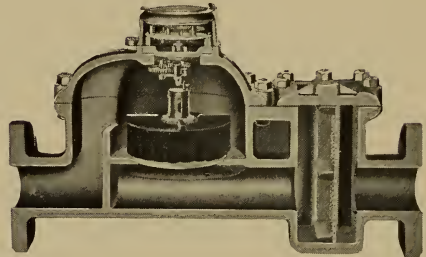

2280-C.

The Hersey Torrent Meter is designed especially with a view to measuring large volumes of water and delivering the same practically without retardation or loss of pressure. It is a current meter operating by the impact of the water upon a wheel which is extremely sensitive, insuring accuracy of registration on small flows. All working parts are non-corrosive, and bearings are heavy and substantial to withstand the most severe service. It is adapted for railroad tanks, elevators and fire services, water motors, and on all services requiring large volumes of water.

Code.....	Quemeful	Quenched	Quenching	Quenelle	Quengeln	Quennecon	Quennons
Size, inches.....	2	3	4	6	8	10	12
Each.....	\$40.00	80.00	160.00	350.00	650.00	800.00	1000.00
Connections.....	No Charge	No Charge	No Charge	No Charge	No Charge	No Charge	No Charge
Capacity per min., cu. ft.....	32	72	128	238	512	800	1152
“ “ “ gallons.....	240	540	960	2160	3840	6000	8640
Length, inches.....	15¼	24	29	36½	48¾	57	68
Width, inches.....	8¾	11	13½	17	20	24	30
Height, inches.....	11½	14¾	18¼	21¾	26½	32	39
Net weight, lbs.....	60	136	230	439	806	1400	2100
Gross weight, lbs.....	87	184	309	543	944	1570	2380

All 2-inch Hersey Torrent Meters are provided with female thread connections. Galvanized iron unions or flange connections are provided, when requested, without extra cost.

All Hersey Torrent Meters from 3 inches to 12 inches inclusive are cast with flanges. Corresponding flanges for wrought iron pipe or bell and spigot connections for cast iron pipe are furnished, when requested, without extra charge.

All Hersey Torrent Meters have strainers forming part of the case.

All Hersey Torrent Meters are provided with ordinary round reading registers adjusted to Cubic Feet, unless otherwise ordered, and are tested on the basis of 62.27 lbs. per Cubic Foot.

In Orders and Specifications give Plate Numbers and Sizes.

NAMES AND NUMBERS OF HERSEY TORRENT METER PARTS.

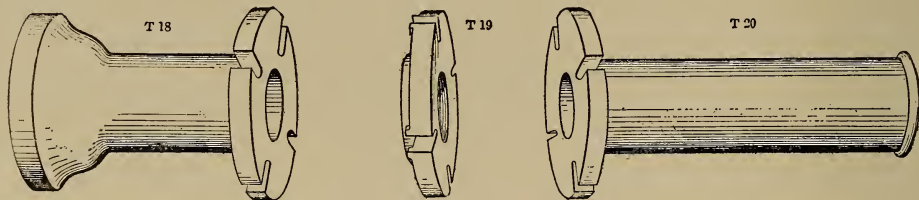
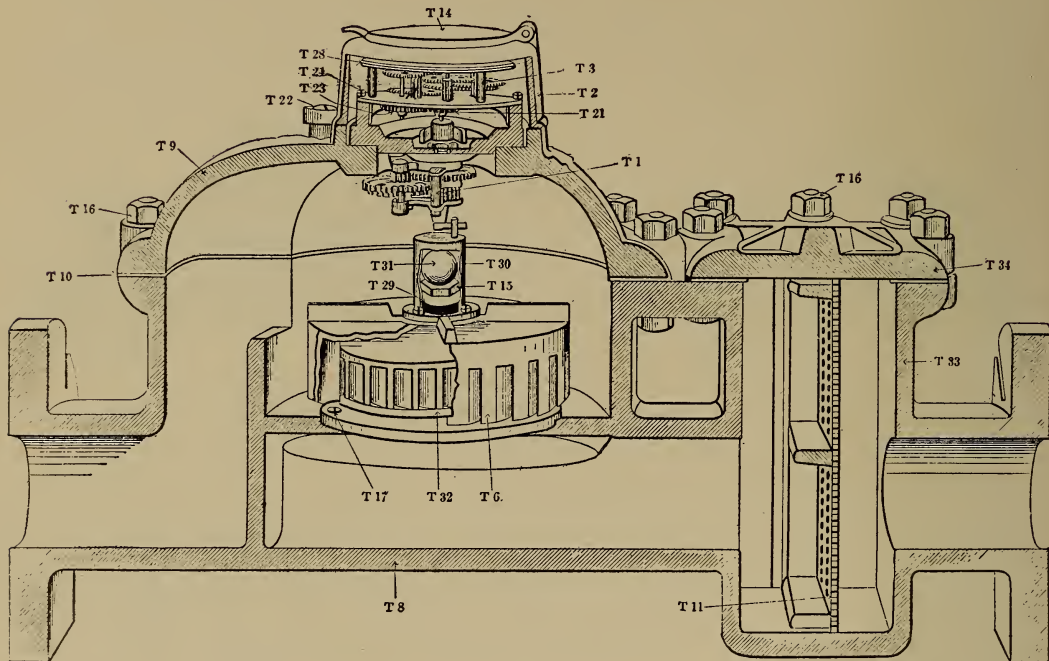

2281-C.

Code.		
Quenotte	T 1	Intermediate Train.
Quentchen	T 2	Bonnet.
Quentura	T 3	Clock.
Quepa	T 6	Hard Rubber Wheel.
Quepais	T 8	Bottom Case.
Quepamus.....	T 9	Top Case.
Querable.....	T 10	Flange Packing.
Queralle.....	T 11	Fish Trap Strainer.
Queraxe	T 14	Lid.
Querband.....	T 15	Spindle.
Querbartes.....	T 16	Flange Bolts.
Querbinden	T 17	Deflector Screws.
Querblick.....	T 18	Bell Connection.

Code.		
Querbogen.....	T 19	Flange Connection.
Querceta	T 20	Spigot Connection.
Quercitron	T 21	Intermediate Train Gear.
Quercubus	T 22	Bonnet Screws.
Quercula.....	T 23	Clock Gear.
Querdamm	T 24	Clock Screws.
Querdurch.....	T 28	Clock Dial.
Querelador.....	T 29	Spindle Bushing.
Querelante.....	T 30	Spindle Cap.
Querelava.....	T 31	Hard Rubber Ball.
Querelis.....	T 32	Deflector.
Querelosi	T 33	Fish Trap Body.
Querenca	T 34	Fish Trap Cover.

All parts of meters are made to interchange.

All meters have a shop number, which is stamped on the lid.

In ordering parts always give the shop number of the meter that the parts are wanted for, and also the name and number of the part.

In Orders and Specifications give Plate Numbers and Sizes.

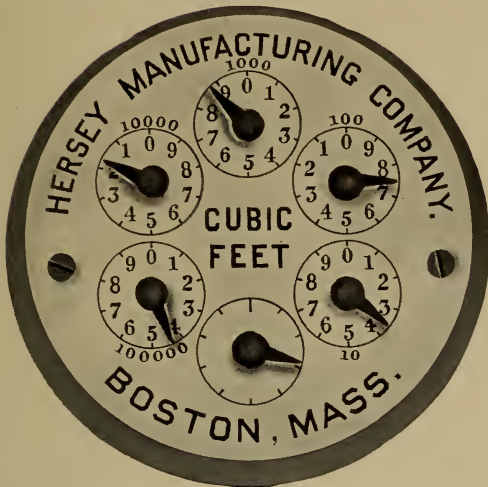
HERSEY METER REGISTERS.**2282-C.**

ROUND READING REGISTER INDICATING 41,873
CUBIC FEET.

Meters are provided with round reading registers adjusted to Cubic Feet, unless otherwise ordered.

Registers can be adjusted to other units of measurement when requested, such as U. S. Gallons, Imperial Gallons, or Litres.

Meters registering in Cubic Feet are tested on the basis of 62.27 lbs. per Cubic Foot.

Meters registering in U. S. Gallons are tested on the basis of 8.34 lbs per Gallon.

Meters registering in Imperial Gallons are tested on the basis of 10 lbs. per Gallon.

Meters registering in Litres are tested on the basis of 2.2 lbs. per Litre.

STRAIGHT READING REGISTER INDICATING 41,873
CUBIC FEET.

All straight reading registers are provided with tight bonnets, making them entirely water, dust and vermin proof, thus insuring non-liability to becoming clogged or corroded.

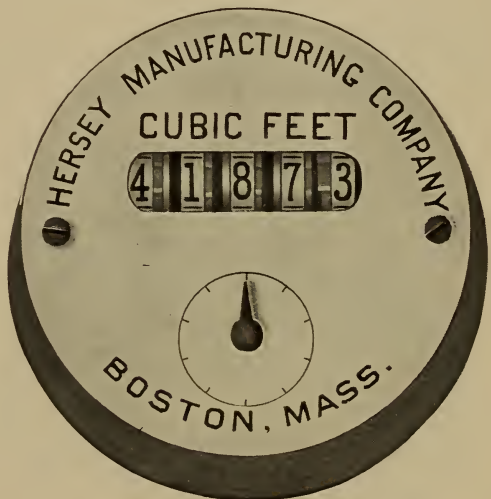
**2283-C.**

Always specify the kind of register and the unit of measurement wanted.

In Orders and Specifications give Plate Numbers.

HERSEY STRAINERS OR FISH TRAPS.

FOR USE BETWEEN METERS AND CONNECTIONS.

SIMPLEX STRAINER.



2284-C.

Consisting of a bronze composition cylindrical shell with a tinned perforated copper removable strainer.

One end is provided with female thread to connect with meter spud; the other end is provided with male I. P. thread.

Code.....	Querfahrt	Querfeld	Querfrage
Size, inches.....	$\frac{5}{8}$	$\frac{3}{4}$	1
Each.....	\$0.50	.75	1.00

CROSSWAY STRAINERS.



2285-C.

This is a galvanized cast iron cylindrical shell with removable heads and perforated brass removable strainer. By removing the heads this strainer can be thoroughly cleaned without removing it from the pipe.

It is provided with female threads.

Code.....	Quergang	Quergasse	Querhaus	Querholz	Querholzes
Size, inches.....	$\frac{5}{8}$	$\frac{3}{4}$	1	1 1/2	2
Each.....	\$2.00	3.00	4.00	5.00	6.00

POT STRAINERS.

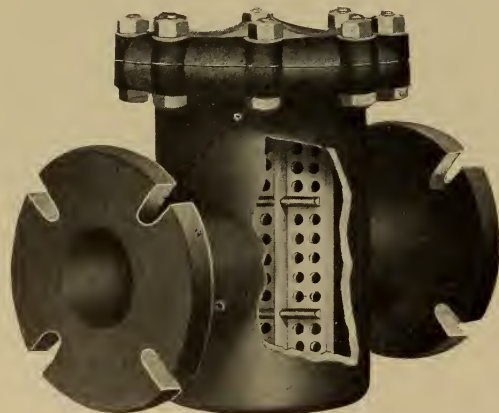

2286-C.

This is a substantial galvanized cast iron pot with perforated removable strainer. It can be cleaned out without removing it from the pipe. It is provided with flanges to match the meter for which it is intended, and when so desired we can supply them with flange on one end and hub or bell on the other, adapted for use with cast iron pipe.

We recommend, especially for large meters, the use of strainers where there is a liability of stones, fish or other foreign bodies passing into the meter. They will prove economical by protecting the meter from serious damage, and thereby avoid repairs.

Code.....	Querima	Querjoch	Querkanal	Querkluft	Querkopf	Querlinie
Size, inches.....	2	3	4	6	8	10
Each.....	\$10.00	15.00	20.00	40.00	100.00	150.00

In Orders and Specifications give Plate Numbers and Sizes.

CONCERNING THE ORDERING OF METERS.

Always specify the **kind** of meter wanted.

Always specify the **size** of meter wanted.

Always specify the **kind of register** and the **unit** of measurement wanted.

Always specify the **kind of connections** you want.

In ordering parts always give the shop number of the meter that the parts are wanted for, and also the name and number of the part.

Always specify whether you want shipment by freight or express, and also the route if you have any preference.

CONCERNING THE SETTING OF METERS.

Blow out supply pipe before putting on a meter.

Set **Meter Level**.

All meters are injured more or less by the action of frost. Care should be taken to set meters so that they are protected thoroughly from freezing.

All meters except hot water meters are injured by the action of heat. When meters are set in connection with boiler supply or where hot water or steam can back into the working parts, care should be taken to place a check valve to protect the meter.

Any substance that is soft or sticky will clog the working parts of a meter ; therefore, red or white lead should not be used in making meter connections.

Meters are designed to measure water and will not pass foreign substances. Supply pipes usually contain accumulation of scale, gravel and dirt, so it is absolutely necessary to blow out supply pipe thoroughly before putting a meter on the pipe.

When meters are open for inspection or repair, see that they are thoroughly cleaned before replacing, and that the moving parts operate freely when they are in their proper place.

In Orders and Specifications give Plate Numbers.

FIDELITY STEAM TRAPS.

FOR HIGH OR LOW PRESSURE.

On the market since 1889. Thousands in use in the largest Mills, Factories and Power Plants in this country.

These Traps are designed to work on a pressure ranging from 30 to 150 pounds per square inch. The Fidelity Trap has no closed floats, levers, cams, diaphragms or expansion plugs.

They will lift water any height, according to the pressure carried, approximately two feet for every pound of pressure.

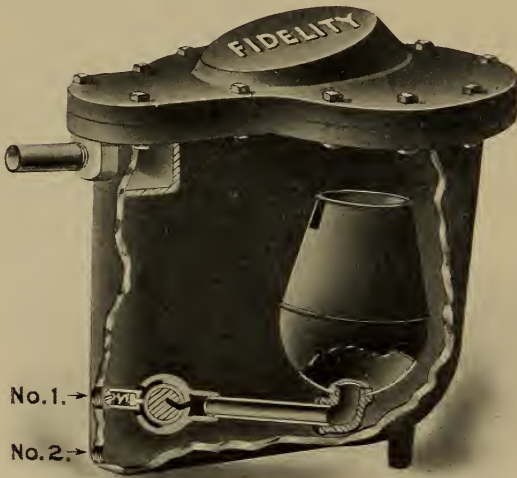

1672-C.

EVERY TRAP GUARANTEED.

The Fidelity Steam Trap is provided with an open float, to which is attached the hollow valve arm, ground to fit the outlet plug.

The valve and valve seat together are a simple rotary valve (as used in all Corliss engines.) It continues to wear its own seat and remains tight; hence it never needs grinding.

The operation is as follows: When the Trap nearly fills with water the float rises to the top closing the outlet valve. The water will then overflow into the float. As soon as the float becomes partially filled with water, it continues to sink, and thus opens the valve, and such water will be forced out at the discharge through the passage way leading from the bottom of the float. The particular feature is that float does not drop to the bottom of the Trap when it is forced down as in other devices of this class, but the downward movement is retarded on

account of the increasing floating power of the float, consequently the Trap discharges the water only as fast as it enters, and in order that the valve may open to a greater extent more water must enter the trap to sink the float proportionately.

CONDENSING CAPACITIES BASED ON A PRESSURE OF 80 POUNDS.

Code.	Nos.	Capacity Lin'l Feet, 1-in. Pipe.	Capacity Sq. Feet Radiation.	Inlet.	Outlet.	Floor to Inlet.	Floor to Outlet.	Net Weight.	Price.
Porphirio	00S	500	200	¾ in.	½ in.	50 lbs.	\$20.00
Porphyr.....	00	1,000	350	1 " "	¾ " "	10 in.	3 in.	100 "	22.00
Porpita	0	2,000	700	1 " "	¾ " "	10 " "	3 " "	100 "	26.00
Porporses.....	1	3,000	1,000	1 " "	¾ " "	10 " "	3 " "	100 "	30.00
Porpora	2	5,000	1,550	1¼ " "	1 " "	11½ " "	3¼ " "	125 "	40.00
Porporine.....	3	10,000	3,000	1½ " "	1¼ " "	12 " "	3¾ " "	150 "	55.00

Always state the pressure under which you wish to use this Trap.

In Orders and Specifications give Plate Numbers and Sizes.

SECTION 8

IRON PIPE AND FITTINGS,

SOIL PIPE AND FITTINGS,

DRAINAGE FITTINGS, ETC.



HOLBROOK, MERRILL & STETSON,
INCORPORATED.

SAN FRANCISCO, LOS ANGELES AND NEW YORK.

WROUGHT PIPE.

We carry a large stock of Standard Pipe up to 6-inch, and can furnish Extra Heavy, Double Extra Heavy and Casing at market prices. Orders for cutting and threading promptly executed.

MALLEABLE PIPE FITTINGS.

Our stock is of Thomas Devlin & Co. make, and guaranteed to be of approved patterns and the most perfect fittings made as to material, construction, etc.

CAST IRON THREADED FITTINGS.

Are of Standard pattern, weight and quality.

CAST IRON SOIL PIPE AND FITTINGS.

We call your special attention, and we consider it of the utmost importance from a sanitary point of view, that **Our Soil Pipe and Fittings** are of superior quality **throughout, sound, uniform in thickness, smooth surface inside and outside**, and can be cut without splitting.

DRAINAGE FITTINGS.

These are threaded and constructed so that when they are screwed to standard pipe a perfect joint is formed and there is no obstruction or unevenness on interior of wastes and vents as there are with the ordinary standard soil pipe. Drainage fittings are used for installing the Durham System of plumbing.

In ordering goods from this section by telegraph, it is only necessary to use the code over or opposite the number or size of the article wanted, preceded by words from code in front of this book.

Example:—Criticum anadido rabbetted and abianus raddrizza and abendzug rainblume.

Translation:—Ship at once two hundred and fifty feet three-quarter-inch Galvanized Pipe and thirty-five three-quarter Galvanized Beaded Elbows and twenty-five Galvanized Beaded Tees.

STANDARD STEAM, GAS AND WATER PIPE.

BLACK AND GALVANIZED.

1-inch and smaller are proved to 300 pounds per square inch hydraulic pressure.

1 1/2-inch and larger are proved to 500 pounds per square inch hydraulic pressure.

Code, Black.	Code, Galvanized.	Code, Dipped.	Sizes, Inches.	Nominal Weight Per Foot, Lbs.	Average Feet in One Bundle.	Thickness, Inches.	* Per Foot.	No. of Threads Per Inch of Screw.
Rababuz.....	Rabanus.....	Rabbrevia.....	1/8	\$0.24	500	.068	\$0.05 1/2	27
Rabacal.....	Rabatage.....	Rabbrusca.....	1/4	0.42	300	.088	.05 1/2	18
Rabacaria.....	Rabbah.....	Rabbuffo.....	3/8	0.56	250	.091	.05 1/2	18
Rabachage.....	Rabbelire.....	Rabeador.....	1/2	0.84	200	.109	.08 1/2	14
Rabachait.....	Rabbetted.....	Raccomuna.....	3/4	1.12	125	.113	.11 1/2	14
Rabacheur.....	Rabbiche.....	Racconsola.....	1	1.67	90	.134	.16 1/2	11 1/2
Rabachions.....	Rabbinado.....	Raccontano.....	1 1/4	2.24	55	.140	.22 1/2	11 1/2
Rabadana.....	Rabbiner.....	Raccontava.....	1 1/2	2.63	55	.145	.27	11 1/2
Rabadanes.....	Rabbunica.....	Raccoppia.....	2	3.61	19	.154	.36	11 1/2
Rabalde.....	Rabbinista.....	Raccorcica.....	2 1/2	5.74	19	.204	.57 1/2	8
Rabalva.....	Rabbioso.....	Raccord.....	3	7.54	19	.217	.75 1/2	8
Rabaneras.....	Rabbitry.....	Raccorder.....	3 1/2	9.00	19	.226	.95	8
Rabanho.....	Rabbonita.....	Raccoupler.....	4	10.66	19	.237	1.08	8
Rabanillo.....	Rabbordare.....	Raccours.....	5	14.50	20	.259	1.45	8
Rabaniza.....	Rabbordo.....	Raccoutre.....	6	18.76	20	.280	1.88	8

* Price List Adopted February 15, 1900.

TABLE OF DIMENSIONS, WEIGHTS, ETC., OF STANDARD STEAM, GAS AND WATER PIPE.

Nominal Internal, Inches.	Diameter.		Circumference.		Area.		Length of Pipe Per Square Foot of External Surface, Feet.	Square Feet of Surface Per Foot in Length.	Length of Pipe Containing One Cubic Foot, Feet.	Contents in *Gallons Per Foot.	Weight of Water Per Foot of Length, Lbs.
	Actual External, Inches.	Actual Internal, Inches.	External, Inches.	Internal, Inches.	External, Square Inches.	Internal, Square Inches.					
1/8	.405	.27	1.272	.848	.129	.0573	9.44	0.106	2500.	.0006	.005
1/4	.54	.364	1.696	1.144	.229	.1041	7.075	0.141	1385.	.0026	.021
3/8	.675	.494	2.121	1.552	.358	.1917	5.657	0.177	751.5	.0057	.047
1/2	.84	.623	2.639	1.957	.554	.3048	4.547	0.220	472.4	.0102	.085
3/4	1.05	.824	3.299	2.589	.866	.5333	3.637	0.275	270.	.0230	.190
1	1.315	1.048	4.131	3.292	1.357	.8626	2.904	0.344	166.99	.0408	.349
1 1/4	1.66	1.38	5.215	4.335	2.164	1.496	2.301	0.434	96.25	.0638	.527
1 1/2	1.9	1.611	5.969	5.061	2.835	2.038	2.01	0.497	70.65	.0918	.760
2	2.375	2.067	7.461	6.494	4.430	3.356	1.608	0.621	42.36	.1632	1.356
2 1/2	2.875	2.468	9.032	7.753	6.491	4.784	1.328	0.753	30.11	.2550	2.116
3	3.5	3.067	10.996	9.636	9.621	7.388	1.091	0.916	19.49	.3673	3.049
3 1/2	4.	3.548	12.566	11.146	12.566	9.887	.955	1.047	14.56	.4998	4.155
4	4.5	4.026	14.137	12.648	15.904	12.73	.849	1.178	11.31	.6528	5.405
5	5.563	5.045	17.477	15.849	24.299	19.99	.687	1.456	7.20	1.020	8.500
6	6.625	6.065	20.813	19.054	34.471	28.888	.577	1.734	4.98	1.469	12.312

* The Standard U. S. Gallon of 231 Cubic Inches.

Black Pipe in random lengths, with threads and couplings, will be shipped unless otherwise ordered. An extra charge will be made for cut lengths or for Plugged and Reamed Pipe.

† Carried in San Francisco only.

In Orders and Specifications give Plate Numbers and Sizes.

STANDARD STEAM, GAS AND WATER PIPE.

ASPHALTUM DIPPED.

Size, inches.....	½	¾	1	1¼	1½	2
Dipping only per 100 feet.....	\$1.50	1.50	1.50	2.00	2.40	3.00
Weight per 100 feet, lbs.....
Size, inches.....	2½	3	3½	4	5	6
Dipping only per 100 feet.....	\$4.00	4.50	5.25	6.00	7.50	9.00
Weight per 100 feet, lbs.....

LIST ON PIPE THREADING.

STANDARD LENGTH THREADS.

Size, inches.....	⅛	¼	⅜	½	¾	1	1¼	1½
Length of thread, inches.....	½	½	½	½	½	1	1	1
Each.....	\$0.05	.05	.05	.05	.05	.06	.07	.08
Size, inches.....	2	2½	3	3½	4	5	6	
Length of thread, inches.....	1½	1½	1½	1½	1½	1¾	1¾	
Each.....	\$0.10	.15	.20	.25	.35	.55	.70	

Cutting Pipe without threads half of above prices.

THREADS LONGER THAN STANDARD LENGTH.

Size, inches.....	⅛	¼	⅜	½	¾	1	1¼	1½
Lengths of threads, 2 inches, each.....	\$0.10	.10	.10	.10	.10	.11	.13	.15
“ “ 3 “ “.....	.14	.14	.14	.14	.14	.16	.19	.22
“ “ 4 “ “.....	.18	.18	.18	.18	.18	.21	.25	.29
“ “ 5 “ “.....	.22	.22	.22	.22	.22	.26	.31	.36
“ “ 6 “ “.....	.26	.26	.26	.26	.26	.31	.37	.43
“ “ 7 “ “.....	.30	.30	.30	.30	.30	.36	.43	.50
“ “ 8 “ “.....	.34	.34	.34	.34	.34	.41	.49	.57
“ “ 9 “ “.....	.38	.38	.38	.38	.38	.46	.55	.64
“ “ 10 “ “.....	.42	.42	.42	.42	.42	.51	.61	.71
“ “ 12 “ “.....	.50	.50	.50	.50	.50	.61	.73	.85
Each additional inch.....	.04	.04	.04	.04	.04	.05	.06	.07
Size, inches.....	2	2½	3	3½	4	5	6	
Lengths of threads, 2 inches, each.....	\$0.15	.20	.27	.33	.45	.61	.77	
“ “ 3 “ “.....	.23	.30	.40	.49	.65	.86	1.07	
“ “ 4 “ “.....	.31	.40	.53	.65	.85	1.11	1.37	
“ “ 5 “ “.....	.39	.50	.66	.81	1.05	1.36	1.67	
“ “ 6 “ “.....	.47	.60	.79	.97	1.25	1.61	1.97	
“ “ 7 “ “.....	.55	.70	.92	1.13	1.45	1.86	2.27	
“ “ 8 “ “.....	.63	.80	1.05	1.29	1.65	2.11	2.57	
“ “ 9 “ “.....	.71	.90	1.18	1.45	1.85	2.36	2.87	
“ “ 10 “ “.....	.79	1.00	1.31	1.61	2.05	2.61	3.17	
“ “ 12 “ “.....	.95	1.10	1.44	1.93	2.45	3.11	3.47	
Each additional inch.....	.08	.10	.13	.16	.20	.25	.30	

Two threads charged for each piece of pipe cut and threaded.

We invariably charge for cutting threads on any pieces of pipe left over. For example: A customer orders one piece of pipe four feet long, both ends threaded. We charge him four feet of pipe and cutting two threads (one thread on the piece shipped and one thread on the piece cut off).

Give all measurements from center to center.

In Orders and Specifications give Plate Numbers and Sizes.

CLASSIFICATION AND LIST.

ADOPTED BY MANUFACTURERS JUNE 19, 1895.

Revised Nov. 4, 1901, and April 10, 1903.

Class.....	A	B	C	*D	**E
Black, per lb.....	\$0.40	.26	.16	.13	.11
Galvanized, per lb.....	.50	.35	.23	.20	.18
Elbows.....	$\left\{ \begin{matrix} \frac{1}{8} \times \frac{1}{8} \\ \frac{1}{4} \times \frac{1}{8} \\ \frac{3}{8} \times \frac{1}{8} \end{matrix} \right\}$	$\left\{ \begin{matrix} \frac{3}{8} \times \frac{1}{4} \\ \frac{1}{2} \times \frac{1}{4} \\ \frac{1}{4} \\ \frac{3}{8} \end{matrix} \right\}$	$\frac{1}{2}$ $\frac{1}{2} \times \frac{3}{8}$	$\frac{3}{4}$ 1	1 $\frac{1}{4}$ and larger
Elbows, R. & L.....	$\frac{1}{4}, \frac{3}{8}$	$\frac{1}{2}$ and smaller	$\frac{3}{4}$ and 1	1 $\frac{1}{4}$ and larger	
Elbows, 60°, 45°.....		$\frac{1}{4}$ and $\frac{3}{8}$	$\frac{3}{4}$ to 2 incl.	2 $\frac{1}{2}$ and larger	
Elbows, Street.....		$\frac{1}{2}$	$\frac{1}{2}, \frac{3}{4}$ to 1x $\frac{3}{4}$	1 and larger	
Elbows, Side Outlet.....		$\frac{1}{2}$ and smaller	$\frac{3}{4}$ and larger		
Elbows, Drop.....		$\frac{1}{2}$ and smaller	$\frac{3}{4}$ and larger		
Tees.....	$\left\{ \begin{matrix} \frac{1}{8} \times \frac{1}{8} \\ \frac{1}{8} \times \frac{1}{4} \\ \frac{1}{4} \times \frac{1}{8} \\ \frac{3}{8} \times \frac{1}{8} \end{matrix} \right\}$	$\left\{ \begin{matrix} \frac{3}{8}, \frac{1}{4} \\ \frac{1}{4} \times \frac{3}{8} \\ \frac{3}{8} \times \frac{1}{4} \times \frac{1}{4} \\ \frac{3}{8} \times \frac{1}{4} \\ \frac{3}{8} \times \frac{1}{4} \times \frac{3}{8} \end{matrix} \right\}$	$\frac{1}{2}$ $\frac{1}{2}$ reduc.	$\frac{3}{4}$ 1	1 $\frac{1}{4}$ and larger
Tees, Four Way.....		$\frac{1}{2}$ and smaller	$\frac{3}{4}$ and larger		
Tees, Drop.....		$\frac{1}{2}$ and smaller	$\frac{3}{4}$ and larger		
Crosses.....		$\frac{1}{4}, \frac{3}{8}$ and $\frac{1}{2}$	$\frac{3}{4}$ and 1	1 $\frac{1}{4}$ and larger	
Crosses, Reducing.....		1 and smaller	1 $\frac{1}{4}$ and larger	
Return Bends.....		$\frac{3}{8}$ and $\frac{1}{2}$	$\frac{3}{4}$ and 1	1 $\frac{1}{4}$ and larger	
Return Bends, R. & L.....	$\frac{3}{8}, \frac{1}{2}$	$\frac{3}{4}$ and 1	1 $\frac{1}{4}$ and larger		
Couplings, R. H.....	$\frac{1}{8}$	$\frac{3}{8}$ and $\frac{1}{4}$	$\frac{1}{2}$ and $\frac{3}{4}$	1 and 1 $\frac{1}{4}$	1 $\frac{1}{2}$ and larger
Couplings, R. & L.....	$\frac{1}{8}$	$\frac{3}{8}$ and $\frac{1}{4}$	$\frac{1}{2}$ and $\frac{3}{4}$	1 and larger	
Couplings, Reducing.....	$\left\{ \begin{matrix} \frac{1}{4} \times \frac{1}{8} \\ \frac{3}{8} \times \frac{1}{8} \end{matrix} \right\}$	$\frac{3}{8} \times \frac{1}{4}$ to $\frac{3}{4} \times \frac{3}{8}$	$\frac{3}{4} \times \frac{1}{2}$ to 1 } inclusive }	1 $\frac{1}{4}$ and larger	
Caps.....		$\frac{3}{8}$ and $\frac{1}{4}$	$\frac{1}{2}, \frac{3}{4}$ and 1	1 $\frac{1}{4}$ and larger	
Locknuts.....		$\frac{1}{4}, \frac{3}{8}$ and $\frac{1}{2}$	$\frac{3}{4}, 1, 1 \frac{1}{4}$	1 $\frac{1}{2}$ and larger	
Extension Pieces.....		$\frac{3}{8}$ and $\frac{1}{2}$	$\frac{3}{4}$ and larger		
Offsets.....		All sizes.		
Waste Nuts.....		$\frac{3}{4}$ and smaller	1 and larger		
Chandelier Hooks.....		All sizes.			
Y's, 45°, 60° or Double.....		$\frac{3}{4}$ and $\frac{1}{2}$	1 and larger		

* Such fittings in Class D as have one or more openings smaller than $\frac{3}{4}$ to be Class C.

** Such fittings in Class E as have one or more openings smaller than 1 inch to be Class D.

The run of tees gives the sizes for the purpose of classification; the outlet being larger does not change it.

In ordering be particular to state whether beaded or plain.

An extra charge will be made for fittings not enumerated in standard list.

In Orders and Specifications give Plate Numbers and Sizes.

MALLEABLE ELBOWS.



2301-C.

Plain.



2302-C.

Beaded.

PLAIN BLACK ELBOWS—2301-C.

Code.....	Racimales	Racimamos	Racimar	Racimo	Racimolare	Racimolo	Racimudos	Racinage	Racineux
Size, inches.....	1/8	1/4	3/8	1/2	3/4	1	1 1/4	1 1/2	2
Class.....	A	B	B	C	D	D	E	E	E
Each.....	\$0.10	.10	.12	.13	.15	.21	.31	.46	.65
Weight per 100, lbs..	9	12	16	24	38	54	90	135	190

PLAIN BLACK RIGHT AND LEFT ELBOWS—2301-C.

Code.....	Racionar	Rackoons	Racktau	Raclement	Racleront	Racleurs	Racloir	Racodiace
Size, inches.....	1/4	3/8	1/2	3/4	1	1 1/4	1 1/2	2
Class.....	A	A	B	C	C	D	D	D
Each.....	\$0.17	.21	.22	.25	.30	.45	.70	1.00
Weight per 100, lbs.....	12	16	24	38	54	90	135	190

BEADED BLACK ELBOWS—2302-C.

Code.....	Racodion	Racoforo	Racolage	Racoma	Racomitra	Racontable	Racontages
Size, inches.....	1/8	1/4	3/8	1/2	3/4	1	1 1/4
Class.....	A	B	B	C	D	D	E
Each.....	\$0.12	.12	.15	.16	.17	.27	.34
Weight per 100, lbs.....	...	13	20	28	44	70	100

Code.....	Racontais	Raconteur	Raconto	Racontons	Racoonda	Racopiles	Racoplaca	Racornira
Size, inches.....	1 1/2	2	2 1/2	3	3 1/2	4	5	6
Class.....	E	E	E	E	E	E	E	E
Each.....	\$0.48	.78	1.60	2.50	3.50	4.50	7.00	12.00
Weight per 100, lbs.....	140	230	425	660	930	1160	1900	3200

PLAIN GALVANIZED ELBOWS—2301-C.

Code.....	Racquetano	Racquetare	Racquitter	Radariste	Radarm	Radazza	Radbeslag	Radbraken
Size, inches.....	1/4	3/8	1/2	3/4	1	1 1/4	1 1/2	2
Class.....	B	B	C	D	D	E	E	E
Each.....	\$0.15	.16	.17	.23	.33	.50	.73	1.00
Weight per 100, lbs.....	12	17	25	40	57	95	140	200

BEADED GALVANIZED ELBOWS—2302-C.

Code.....	Raddia	Raddoppi	Raddossare	Raddrizza	Radeaux	Radeloozer
Size, inches.....	1/4	3/8	1/2	3/4	1	1 1/4
Class.....	B	B	C	D	D	E
Each.....	\$0.17	.20	.21	.26	.42	.55
Weight per 100, lbs.....	15	21	26	45	73	106

Code.....	Raderbalk	Raderkast	Raderloop	Raderworm	Radevicus	Radevore
Size, inches.....	1 1/2	2	2 1/2	3	3 1/2	4
Class.....	E	E	E	E	E	E
Each.....	\$0.78	1.25	2.60	4.00	6.00	7.00
Weight per 100, lbs.....	150	240	450	700	980	1220

In Orders and Specifications give Plate Numbers and Sizes.

MALLEABLE ELBOWS.



2303-C.

Plain Reducing.



2304-C.

Plain 45°.



2305-C.

Beaded 45°.

PLAIN BLACK REDUCING ELBOWS—2303-C.

Code	Radfelge	Radgarn	Radhaspel	Radiadas	Radiancy	Radiately	Radiatule
Size, inches.....	$\frac{3}{4} \times \frac{1}{4}$	$\frac{1}{2} \times \frac{3}{8}$	$\frac{3}{4} \times \frac{3}{8}$	$\frac{3}{4} \times \frac{1}{2}$	1x$\frac{1}{2}$	1x$\frac{3}{4}$	1$\frac{1}{4}$ x $\frac{3}{4}$
Class.....	B	C	C	C	C	D	D
Each.....	\$0.15	.16	.17	.17	.27	.27	.34
Weight per 100, lbs.....	16	24	38	38	54	54	90

Code	Radicabar	Radicabunt	Radicada	Radicalism	Radicamos	Radicularian	Radicavit	Radicchio
Size, inches.....	1$\frac{1}{4}$ x 1	1$\frac{1}{2}$ x $\frac{3}{4}$	1$\frac{1}{2}$ x 1	1$\frac{1}{2}$ x 1$\frac{1}{4}$	2x$\frac{3}{4}$	2x1$\frac{1}{4}$	2x1$\frac{1}{2}$	2$\frac{1}{2}$ x 2
Class.....	E	D	E	E	D	E	E	E
Each.....	\$0.34	.48	.48	.48	.78	.78	.78	1.60
Weight per 100, lbs...	90	135	135	130	190	190	190	425

PLAIN GALVANIZED REDUCING ELBOWS—2303-C.

Code.....	Radicelle	Radichella	Radicibus	Radiform	Radicivore	Radicone	Radicosas
Size, inches.....	$\frac{1}{2} \times \frac{3}{8}$	$\frac{3}{4} \times \frac{1}{2}$	1x$\frac{3}{4}$	1$\frac{1}{4}$ x 1	1$\frac{1}{2}$ x 1$\frac{1}{4}$	2x1$\frac{1}{4}$	2x1$\frac{1}{2}$
Class.....	C	C	D	E	E	E	E
Each.....	\$0.21	.26	.42	.55	.78	1.25	1.25
Weight per 100, lbs.....	25	40	57	95	140	200	200

PLAIN GALVANIZED 45° ELBOWS—2304-C.

Code.....	Radicular	Radiculode	Radigast	Radimadia
Size, inches.....	1$\frac{1}{4}$	1$\frac{1}{2}$	2	2$\frac{1}{2}$
Class.....	C	C	C	D
Each.....	\$0.60	.65	1.10	2.00
Weight per 100, lbs.....	80	90	150	260

BEADED BLACK 45° ELBOWS—2305-C.

Code.....	Radiola	Radiolos	Radiometro	Radiosus	Radique	Radkranz	Radlaufen
Size, inches.....	$\frac{1}{4}$	$\frac{3}{8}$	$\frac{1}{2}$	$\frac{3}{4}$	1	1$\frac{1}{4}$	1$\frac{1}{2}$
Class.....	B	B	B	C	C	C	C
Each.....	\$0.12	.14	.18	.19	.33	.45	.55
Weight per 100, lbs.....	10	14	22	36	63	86	100

Code.....	Radloch	Radnaaf	Radoter	Radoub	Radres	Radreif	Radslot
Size, inches.....	2	2$\frac{1}{2}$	3	3$\frac{1}{2}$	4	5	6
Class.....	C	D	D	D	D	D	D
Each.....	\$0.85	1.50	2.00	4.00	5.00
Weight per 100, lbs.....	160	260	350	700	950	1250

BEADED GALVANIZED 45° ELBOWS—2305-C.

Code.....	Radspaak	Radsparre	Rad sprung	Radspur	Radstock	Radstoss
Size, inches.....	$\frac{1}{4}$	$\frac{3}{8}$	$\frac{1}{2}$	$\frac{3}{4}$	1	1$\frac{1}{4}$
Class.....	B	B	B	C	C	C
Each.....	\$0.13	.16	.26	.28	.47	.65
Weight per 100, lbs.....	11	15	24	38	65	90

Code.....	Radules	Radulpho	Radunassi	Radunata	Raduniata	Radunt
Size, inches.....	1$\frac{1}{2}$	2	2$\frac{1}{2}$	3	3$\frac{1}{2}$	4
Class.....	C	C	D	D	D	D
Each.....	\$0.76	1.25	2.10	3.00	6.00	8.00
Weight per 100, lbs.....	105	170	270	360	730	1000

In Orders and Specifications give Plate Numbers and Sizes.

MALLEABLE ELBOWS.



2308-C.
Plain 60°.



2309-C.
Street Elbow.



2310-C.
Side Outlet.

PLAIN GALVANIZED 60° ELBOWS—2308-C.

Code.....	Radwelle	Radzapfen	Raesaces	Raethin
Size, inches.....	1 1/4	1 1/2	2	2 1/2
Class.....	C	C	C	D
Each.....	\$0.60	.65	1.10	2.00
Weight per 100, lbs.....	80	90	150	260

BLACK STREET ELBOWS—2309-C.

Code.....	Raethsel	Raetos	Raebur	Rafael	Rafalant	Rafanella	Rafanino	Rafeling	Rafeo
Size, inches.....	1/4	3/8	1/2	3/4	*3/4 x 1/2	1	1 1/4	1 1/2	2
Class.....	B	B	C	C	C	D	D	D	D
Each.....	\$0.12	.13	.18	.23	.23	.33	.45	.65	1.00
Weight per 100, lbs.	12	16	24	44	44	76	100	150	230

*3/4-inch Female by 1/2-inch Male.

GALVANIZED STREET ELBOWS—2309-C.

Code.....	Raffaello	Raffammo	Raffando	Raffarono	Raffassimo	Raffaux	Raffavate	Raffendes
Size, inches.....	1/4	3/8	1/2	3/4	1	1 1/4	1 1/2	2
Class.....	B	B	C	C	D	D	D	D
Each.....	\$0.16	.17	.26	.36	.50	.67	1.00	1.60
Weight per 100, lbs.....	12	16	25	48	80	105	158	240

BLACK SIDE OUTLET ELBOWS—2310-C.

Code.....	Rafferemo	Raffermir	Raffgut	Raffholz	Raffica	Raffigura	Raffilasse
Size, inches.....	3/8	1/2	3/4	1	1 1/4	1 1/2	2
Class.....	B	B	C	C	C	C	C
Each.....	\$0.16	.30	.34	.38	.70	.94	1.50
Weight per 100, lbs.....	16	30	40	60	110	150	230

GALVANIZED SIDE OUTLET ELBOWS—2310-C.

Code.....	Raffinage	Raffineur	Raffinons	Rafflesia	Raffolait	Raffoleras	Raffoliez
Size, inches.....	3/8	1/2	3/4	1	1 1/4	1 1/2	2
Class.....	B	B	C	C	C	C	C
Each.....	\$0.24	.40	.48	.55	1.00	1.40	2.00
Weight per 100 lbs.....	18	32	42	63	115	160	240

In Orders and Specifications give Plate Numbers and Sizes.

MALLEABLE ELBOWS.



2313-C.

Female Drop Elbow.



2314-C.

Long Male and Female.



2315-C.

Short Male and Female.

BLACK FEMALE DROP ELBOWS—2313-C.

Code.....	Rafforzare	Rafforzato	Rafforzava	Rafforzo	Raffossano
Size, inches.....	† $\frac{1}{4}$	$\frac{3}{8}$	$\frac{1}{2}$	† $\frac{3}{4}$	†1
Class.....	B	B	B	C	C
Each.....	\$0.13	.18	.30	.40	.50
Weight per 100, lbs.....	13	18	30	45	75

†GALVANIZED FEMALE DROP ELBOWS—2313-C.

Code.....	Raffranca	Raffranchi	Raffronta
Size, inches.....	$\frac{3}{8}$	$\frac{1}{2}$	$\frac{3}{4}$
Class.....	B	B	C
Each.....	\$0.25	.45	.60
Weight per 100, lbs.....	19	32	47

BLACK SHORT MALE AND FEMALE DROP ELBOWS—2315-C.

Code.....	Raffubler	Raffzahn
Size, inches.....	$\frac{3}{8}$	$\frac{1}{2} \times \frac{3}{8}$
Class.....	B	B
Each.....	\$0.26	.40
Weight per 100, lbs.....	26	40

BLACK LONG MALE AND FEMALE DROP ELBOWS—2314-C.

Drop 2½ Inches Long.

Code.....	Rafid'a
Size, inches.....	$\frac{3}{8}$
Class.....	B
Each.....	\$0.35
Weight per 100, lbs.....	32

†GALVANIZED LONG MALE AND FEMALE DROP ELBOWS—2314-C.

Drop 2½ Inches Long.

Code.....	Rafinar
Size, inches.....	$\frac{3}{8}$
Class.....	B
Each.....	\$0.45
Weight per 100, lbs.....	33

†Carried in San Francisco only.

In Orders and Specifications give Plate Numbers and Sizes.

MALLEABLE Y'S.



†2318-C.

Beaded 45° Y's.

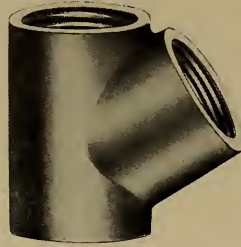

†2319-C.

Plain 60° Y's.



†2320-C.

Plain 45° Double Y's.

†PLAIN GALVANIZED 45° Y'S.

Code	Rafade	Rafleux	Raftsman	Ragache	Ragarum	Ragazza	Rageful
Size, inches.....	3/4	1	1 1/4	1 1/2	2	2x1 1/2	2x1 1/2x1 1/2
Class	B	C	C	C	C	C	C
Each.....	\$1.10	1.20	1.30	2.00	2.50	2.50	2.50
Weight per 100, lbs.....	100	160	180	260	350	350	350
Code.....				Raggedly	Raggles	Raggravo	Raggrotta
Size, inches.....				2x1 1/2x2	2 1/2	2 1/2x2	3
Class.....				C	C	C	C
Each.....				\$2.50	5.00	5.00	10.00
Weight per 100, lbs.....				350	650	600	1400

†BEADED BLACK 45° Y'S—2318-C.

Code	Raggruppa	Ragingly	Ragnachar	Ragnahild	Ragnatela	Ragnitello	Ragnuola
Size, inches.....	3/4	1	1 1/4	1 1/2	2	2 1/2	3
Class	B	C	C	C	C	C	C
Each	\$0.80	.85	.90	1.30	1.80	3.50	7.00
Weight per 100, lbs.....	100	150	170	250	350	600	1300

†PLAIN GALVANIZED 60° Y'S—2319-C.

Code.....		Ragodia	Ragondin	Ragosse	Ragouner
Size, inches		1 1/2	2	2x1 1/2	2x1 1/2x2
Class.....		C	C	C	C
Each.....		\$2.00	2.50	2.50	2.50
Weight per 100, lbs		190	290	225	275

†PLAIN GALVANIZED 45° DOUBLE Y'S—2320-C.

Code.....		Ragoutant	Ragrafer	Ragrement
Size, inches.....		1 1/2	2	2x1 1/2
Class.....		C	C	C
Each		\$3.00	4.00	4.00
Weight per 100, lbs		400	500	500

†Carried in San Francisco only.

In Orders and Specifications give Plate Numbers and Sizes.

MALLEABLE TEES.



2323-C.

Plain.



2324-C.

Beaded.

In describing Tees the Run is first named, then the Outlet, thus:

$$\frac{1}{2} T \frac{3}{8} = \frac{1}{2} \times \frac{3}{8} \times \frac{3}{4}.$$

$$\frac{1}{2} T \frac{1}{2} = \frac{1}{2} \times \frac{3}{8}.$$

PLAIN BLACK TEES—2323-C.

Code.....	Ragstone	Raguettes	Ragusano	Raguseas	Ragweed	Ragwool	Ragwork	Rahezado	Rahezar
Size, inches.....	$\frac{1}{8}$	$\frac{1}{4}$	$\frac{3}{8}$	$\frac{1}{2}$	$\frac{3}{4}$	1	1$\frac{1}{4}$	1$\frac{1}{2}$	2
Class.....	A	B	B	C	D	D	E	E	E
Each.....	\$0.11	.11	.15	.16	.18	.26	.40	.55	.80
Weight per 100, lbs.....	10	14	20	32	46	66	120	160	230

BEADED BLACK TEES—2324-C.

Code.....	Rahezeis	Rahmens	Rahmholz	Rahmkaese	Rahmleiste	Rahmsack	Rahmtorte	Rahsegel	Raidimes
Size, inches.....	$\frac{1}{8}$	$\frac{1}{4}$	$\frac{3}{8}$	$\frac{1}{2}$	$\frac{3}{4}$	1	1$\frac{1}{4}$	1$\frac{1}{2}$	2
Class.....	A	B	B	C	D	D	E	E	E
Each.....	\$0.13	.13	.18	.19	.20	.32	.48	.60	.90
Weight per 100, lbs.....	15	24	34	50	80	140	180	270

Code.....	Raidir	Raidiront	Raidissant	Raifort	Raigales	Raigambre
Size, inches.....	2 $\frac{1}{2}$	3	3 $\frac{1}{2}$	4	5	6
Class.....	E	E	E	E	E	E
Each.....	\$1.80	2.80	3.80	5.00	9.50	13.00
Weight per 100, lbs.....	480	740	1000	1350	2400	3300

PLAIN GALVANIZED TEES—2323-C.

Code.....	Raigeoir	Raigota	Raigotoso	Raigrases	Raiguiser	Raillardes	Raillerront	Raillons
Size, inches.....	$\frac{1}{8}$	$\frac{1}{4}$	$\frac{3}{8}$	$\frac{1}{2}$	$\frac{3}{4}$	1	1 $\frac{1}{4}$	2
Class.....	A	B	B	C	D	D	E	E
Each.....	\$0.16	.16	.19	.20	.27	.40	.65	.85
Weight per 100, lbs.....	15	20	30	47	70	125	160

BEADED GALVANIZED TEES—2324-C.

Code.....	Raillure	Raimondite	Rainbeat	Rainbeere	Rainblume	Rainbow
Size, inches.....	$\frac{1}{8}$	$\frac{1}{4}$	$\frac{3}{8}$	$\frac{1}{2}$	$\frac{3}{4}$	1
Class.....	A	B	B	C	D	D
Each.....	\$0.18	.18	.24	.25	.32	.50
Weight per 100, lbs.....	15	25	35	55	85

Code.....	Rainfall	Rainfarn	Rainkohl	Rainulf	Rainweide	Raiponce	Raisonnant
Size, inches.....	1 $\frac{1}{4}$	1 $\frac{1}{2}$	2	2 $\frac{1}{2}$	3	3 $\frac{1}{2}$	4
Class.....	E	E	E	E	E	E	E
Each.....	\$0.75	1.00	1.45	3.00	4.50	7.00	8.00
Weight per 100, lbs.....	145	190	280	500	780	1180	1400

† Carried in San Francisco only.

In Orders and Specifications give Plate Numbers and Sizes.

MALLEABLE TEES.

PLAIN BLACK REDUCING TEES.

Code.....	Raitammo	Raitarono	Raitasse	Raitavate	Raizame	Rajadillo	Rajadizas	Rajagrih
Size, inches.....	¼ x 1½	¼ x ¾	¾ x ¼ x ¼	¾ x ¼ x ¾	¾ x ¼	¾ x ½	½ x ¼	½ x ¾ x ¾
Class.....	A	B	B	B	B	B	C	C
Each	\$0.13	.13	.18	.18	.18	.18	.19	.19
Weight per 100, lbs...	12	14	14	17	14	20	21	22
Code.....	Rajahship	Rajanies	Rajoutait	Rajput	Rajustais	Rajuste	Rajustons	Rakelstok
Size, inches.....	½ x ¾	½ x ¾ x ½	½ x ¾ x ¾	½ x ¾	¾ x ¾ x ¾	¾ x ¾ x ½	¾ x ½ x ¾	¾ x ½ x ½
Class.....	C	C	C	C	C	C	C	C
Each	\$0.19	.19	.19	.19	.20	.20	.20	.20
Weight per 100, lbs...	24	28	32	32	39	42	39	43
Code.....	Rakestale	Raketbal	Raketchen	Raketslag	Raketspel	Raketrots	Rakshasa	
Size, inches.....	¾ x ¼	¾ x ¾	¾ x ½	¾ x ¾ x ¾	¾ x ¾ x ¾	¾ x ½ x 1	¾ x 1	
Class.....	C	C	C	C	C	C	D	
Each	\$0.20	.20	.20	.20	.20	.20	.20	
Weight per 100, lbs...	36	37	41	45	46	48½	46	
Code.....	Ralamente	Raleando	Ralentiras	Raleona	Raleurs	Ralhos	Ralinghi	
Size, inches.....	¾ x 1¼	1 x ¾ x ½	1 x ¾ x ¾	1 x ½ x ¾	1 x ½ x ¾	1 x ½ x ¾	1 x ¾ x ¾	
Class.....	D	C	C	C	D	C	C	
Each	\$0.20	.32	.32	.32	.32	.32	.32	
Weight per 100, lbs...	54	51	65	63	66	56	57	
Code.....	Rallaban	Rallargo	Ralleggia	Rallentano	Rallento	Rallevia	Rallones	
Size, inches.....	1 x ½ x ½	1 x ¾ x ½	1 x ¾ x 1	1 x ½ x 1	1 x ¾ x 1	1 x ¼	1 x ¾	
Class.....	C	C	C	C	D	C	C	
Each	\$0.32	.32	.32	.32	.32	.32	.32	
Weight per 100, lbs...	61	60	64½	61	62	54	59	
Code.....	Rallonger	Rallumer	Ramagem	Ramagious	Ramailler	Ramalhada	Ramalhudo	
Size, inches.....	1 x ½	1 x ¾	1 x ¾ x 1¼	1 x ½ x 1¼	1 x ¾ x 1¼	1 x 1¼	1 x ½	
Class.....	C	D	C	D	D	D	D	
Each	\$0.32	.32	.32	.32	.32	.32	.32	
Weight per 100, lbs...	62	66	75	78¼	81¼	84½	100	
Code.....	Ramalines	Ramaliun	Ramames	Ramandot	Ramassage	Ramastique	Ramatella	
Size, inches.....	1¼ x 1 x ¾	1¼ x 1 x ½	1¼ x 1 x ¾	1¼ x ¾ x ¾	1¼ x 1 x 1	1¼ x ¾ x 1	1¼ x ½ x 1	
Class.....	D	D	D	D	E	D	D	
Each	\$0.48	.48	.48	.48	.48	.48	.48	
Weight per 100, lbs...	79	79	89	89	101	101	98	
Code.....	Ramazan	Rambades	Rambeh	Ramberge	Ramblazo	Ramblok	Rambootan	
Size, inches.....	1¼ x ¾ x 1	1¼ x ¾	1¼ x ½	1¼ x ¾	1¼ x 1	1¼ x ½ x 1¼	1¼ x ¾ x 1¼	
Class.....	D	D	D	D	E	D	D	
Each	\$0.48	.48	.48	.48	.48	.48	.48	
Weight per 100, lbs...	98	76	80	95	104	120	116	
Code.....	Rambooze	Rambotim	Rambour	Rameal	Rameggia	Ramelles	Ramenable	
Size, inches.....	1¼ x 1 x 1¼	1¼ x 1½	1¼ x 2	1½ x 1 x 1	1½ x 1¼ x 1	1½ x 1 x 1¼	1½ x 1¼ x 1¼	
Class.....	E	E	E	E	E	E	E	
Each	\$0.48	.48	.48	.60	.60	.60	.60	
Weight per 100, lbs...	120	122	156¼	163	160	155	152	
Code.....	Ramendage	Ramenons	Ramentace	Ramentos	Ramentum	Rameous	Ramequin	
Size, inches.....	1½ x ¾	1½ x ½	1½ x ¾	1½ x 1	1½ x 1¼	1½ x ½ x 1	1½ x ¾ x 1¼	
Class.....	D	D	D	E	E	D	D	
Each	\$0.60	.60	.60	.60	.60	.60	.60	
Weight per 100, lbs...	102	97	117	132	147	162	157	
Code.....	Ramescent	Rameurs	Ramhout	Ramiferes	Ramiflore	Ramify	Ramilaf	
Size, inches.....	1½ x 1¼ x ¾	1½ x 1¼ x 1½	1½ x 2	2 x 1¼ x 1¼	2 x 1½ x 1¼	2 x 1½ x 1	2 x 1½ x 2	
Class.....	D	E	E	E	E	E	E	
Each	\$0.60	.60	.60	.90	.90	.90	.90	
Weight per 100, lbs...	137	160	192	211	214	194	254	
Code.....	Ramilhete	Ramillon	Raminghi	Ramingue	Ramipare	Ramist	Ramitibus	
Size, inches.....	2 x ¾	2 x ½	2 x ¾	2 x 1	2 x 1¼	2 x 1½	2 x 2½	
Class.....	D	D	D	E	E	E	E	
Each	\$0.90	.90	.90	.90	.90	.90	.90	
Weight per 100, lbs...	155	170	183	197	214	230	250	

In Orders and Specifications give Plate Numbers and Sizes.

MALLEABLE TEES.

BEADED BLACK REDUCING TEES.

Code	Rammish	Rammklotz	Rammoli	Ramonti	Ranneos	Rammer	Ramognato
Size, inches.....	½x¼	½x¾	¾x¾	¾x½	1x¾	1x½	1x¾
Class	C	C	C	C	C	C	D
Each	\$0.19	.19	.20	.20	.32	.32	.32
Weight per 100, lbs.	30	34	45	50	73	75	80
Code	Ramolir	Ramorage	Ramondies	Ramonelle	Ramoneur	Ramoon	Ramoruto
Size, inches	1¼x¾	1¼x½	1¼x¾	1¼x1	1½x½	1½x¾	1½x1
Class	D	D	D	E	D	D	E
Each.....	\$0.48	.48	.48	.48	.60	.60	.60
Weight per 100, lbs.	108	112	130	140	124	146	163
Code	Ramoscello	Ramosorum	Rampacious	Rampante	Rampantly	Ramparts	Rampeau
Size, inches	1½x1¼	2x¾	2x½	2x¾	2x1	2x1¼	2x1½
Class	E	D	D	D	E	E	E
Each.....	\$0.60	.90	.90	.90	.90	.90	.90
Weight per 100, lbs.	180	182	199	215	221	255	270
Code	Ramphides	Ramphine	Rampholite	Rampicava	Rampichet	Rampicone	Ramplonas
Size, inches	2½x1	2½x1¼	2½x1½	2½x2	3x1	3x1¼	3x1½
Class	E	E	E	E	E	E	E
Each	\$1.80	1.80	1.80	1.80	2.80	2.80	2.80
Weight per 100, lbs.....	400	410	440	480	750	730	720
Code.....		Rampogni	Rampojo	Ramponeau	Rampostan	Ramshoorn	
Size, inches.....		3x2	3x2½	4x2	4x2½	4x3	
Class.....		E	E	E	E	E	
Each.....		\$2.80	2.80	5.00	5.00	5.00	
Weight per 100, lbs.		770	740	1000	940	1000	

PLAIN GALVANIZED REDUCING TEES.

Code.....	Ramskin	Ramswag	Ramtil	Ramulous	Ramuncule	Ramusculo	Rananite
Size, inches.....	½x¾	½x¾	¾x½x½	¾x½	¾x½x¾	¾x1	1x¾x¾
Class.....	C	C	C	C	C	D	D
Each.....	\$0.25	.25	.32	.32	.32	.32	.50
Weight per 100, lbs.....	30	38	43	41	47	57	62
Code.....		Ranatra	Ranboada	Rancajo	Rancauca	Rancava	Rancebunt
Size, inches.....		1x¾x½	1x¾x1	1x½	1x¾	1x1¼	1¼x1x1
Class.....		D	D	C	D	D	E
Each.....		\$0.50	.50	.50	.50	.50	.75
Weight per 100, lbs.....		54	70	54	58	89	92
Code.....	Rancettes	Rancheaba	Rancheamos	Rancheases	Ranchiamo	Rancidura	
Size, inches.....	1¼x½	1¼x¾	1¼x1	1¼x1x1¼	1¼x1½	1¼x2	
Class.....	D	D	E	E	E	E	
Each.....	\$0.75	.75	.75	.75	.75	.75	
Weight per 100, lbs.....	71	85	94	110	125	156¼	
Code.....		Ranciando	Rancidabo	Rancidavit	Rancidity	Rancido	Rancisse
Size, inches.....		1½x1¼x1¼	1½x½	1½x¾	1½x1	1½x1¼	2x1½x1½
Class.....		E	D	D	E	E	E
Each.....		\$1.00	1.00	1.00	1.00	1.00	1.45
Weight per 100, lbs.....		164	110	130	145	160	233
Code.....		Rancorem	Rancoroso	Rancorous	Rancoura	Rancune	Rancunier
Size, inches.....		2x1½x2	2x½	2x¾	2x1	2x1¼	2x1½
Class.....		E	D	D	E	E	E
Each.....		\$1.45	1.45	1.45	1.45	1.45	1.45
Weight per 100, lbs.....		253	170	183	197	224	240

In Orders and Specifications give Plate Numbers and Sizes.

MALLEABLE TEES.



†2327-C.

Female Drop Tee.



†2328-C.

Male and Female Drop Tee.



†2329-C.

Side Outlet Tee.

†PLAIN BLACK FEMALE DROP TEES—2327-C.

Code	Randagio	Randalies	Randanite	Randlos	Randnoot	Randolfo	Randomly	Randstab
Size, inches.....	3/8	1/2 x 3/8 x 3/8	1/2 x 3/8	1/2	3/4 x 1/2 x 3/8	3/4 x 3/8	3/4 x 1/2	3/4
Class	B	B	B	B	C	C	C	C
Each	\$0.20	.33	.33	.33	.35	.35	.35	.35
Weight per 100, lbs..	20	29	31	35	41	39	44	50

†PLAIN GALVANIZED FEMALE DROP TEES—2327-C.

Code.....	Randvoll	Ranfasto	Ranfione	Rangedor
Size, inches.....	3/8	1/2	3/4 x 1/2	3/4
Class.....	B	B	C	C
Each.....	\$0.27	.48	.50	.50
Weight per 100, lbs.....	21	37	44	55

†PLAIN BLACK MALE AND FEMALE DROP TEES—2328-C.

Code	Rangeons	Rangeur	Rangfolge	Rangifero	Rangloge	Rangolosa	Rangomela
Size, inches.....	3/8	*3/8 Long	1/2 x 3/8 x 3/8	1/2 x 3/8	3/4 x 1/2 x 3/8	3/4 x 3/8	1 x 3/8
Class	B	B	B	B	C	C	C
Each	\$0.22	.26	.30	.30	.32	.32	.35
Weight per 100, lbs..	22	26	29	30	40	40	55

*Drop 2 1/2 inches long.

PLAIN BLACK SIDE OUTLET TEES—2329-C.

Code	Rangorde	Rangstolz	Rangstufe	Ranhosa	Ranhura	Ranilhas	Ranimant
Size, inches.....	†3/8	1/2	3/4	†1	†1 1/4	†1 1/2	†2
Class	B	B	C	C	C	C	C
Each	\$0.22	.30	.37	.45	.80	1.10	1.60
Weight per 100, lbs..	22	30	40	70	130	180	230

†PLAIN GALVANIZED SIDE OUTLET TEES—2329-C.

Code	Ranivores	Rankheid	Rankig	Rankling	Rannesto	Rannosa	Ranankels
Size, inches.....	3/8	1/2	3/4	1	1 1/4	1 1/2	2
Class.....	B	B	C	C	C	C	C
Each	\$0.30	.45	.55	.65	1.25	1.70	2.25
Weight per 100, lbs..	23	32	42	74	140	190	260

†Carried in San Francisco only.

In Orders and Specifications give Plate Numbers and Sizes.

MALLEABLE CROSSES.



2332-C.
Plain.



2333-C.
Beaded.

PLAIN BLACK CROSSES—2332-C.

Code.....	Ranpike	Ransack	Ranseling	Ranterism	Ranular	Ranunkel	Rapace	Rapaceria
Size, inches.....	† $\frac{1}{4}$	$\frac{3}{8}$	$\frac{1}{2}$	$\frac{3}{4}$	1	$1\frac{1}{4}$	$1\frac{1}{2}$	2
Class.....	B	B	B	C	C	D	D	D
Each.....	\$0.13	.17	.23	.28	.39	.61	.74	1.20
Weight per 100, lbs....	15	20	28	54	75	140	170	270
Code.....	Rapacite	Rapadura	Rapagao	Rapailler	Rapaisant	Rapapies		
Size, inches.....	† $\frac{1}{2} \times \frac{3}{8} \times \frac{3}{8} \times \frac{3}{8}$	† $\frac{1}{2} \times \frac{3}{8}$	† $\frac{3}{4} \times \frac{1}{2} \times \frac{3}{8} \times \frac{3}{8}$	† $\frac{3}{4} \times \frac{1}{2} \times \frac{1}{2} \times \frac{1}{2}$	† $\frac{3}{4} \times \frac{3}{8}$	† $\frac{3}{4} \times \frac{1}{2}$		
Class.....	B	B	B	B	B	B		
Each.....	\$0.23	.23	.28	.28	.28	.28		.28
Weight per 100, lbs....	27	28	54	54	51	54 $\frac{1}{2}$		
Code.....	Rapapolyvo	Rapariga	Rapassier	Rapassome	Rapatelle	Rapelho	Rapendos	
Size, inches.....	† $1 \times \frac{3}{4} \times \frac{1}{2} \times \frac{1}{2}$	† $1 \times \frac{3}{4} \times \frac{3}{4} \times \frac{3}{4}$	† $1 \times \frac{3}{8}$	† $1 \times \frac{1}{2}$	$1 \times \frac{3}{4}$	† $1 \frac{1}{4} \times 1 \times \frac{3}{4}$	† $1 \frac{1}{4} \times \frac{1}{4} \times 1 \times \frac{3}{8}$	
Class.....	B	B	B	B	B	D	C	
Each.....	\$0.39	.39	.39	.39	.39	.61	.61	
Weight per 100, lbs....	77	77	69	74	75	148	130	
Code.....	Rapetasser	Rapeux	Raphaim	Raphanie	Raphanus	Raphidia	Raphilite	
Size, inches.....	† $1 \frac{1}{4} \times \frac{1}{2}$	† $1 \frac{1}{4} \times \frac{3}{4}$	$1 \frac{1}{4} \times 1$	† $1 \frac{1}{2} \times \frac{3}{8}$	† $1 \frac{1}{2} \times \frac{1}{2}$	† $1 \frac{1}{2} \times \frac{3}{4}$	$1 \frac{1}{2} \times 1$	
Class.....	C	D	D	C	C	D	D	
Each.....	\$0.61	.61	.61	.74	.74	.74	.74	
Weight per 100, lbs....	138	144	140	93	100	114	124	
Code.....	Raphipodes	Raphon	Rapidez	Rapidolite	Rapidulos	Rapiforme	Rapimmo	
Size, inches.....	† $1 \frac{1}{2} \times 1 \frac{1}{4}$	† $1 \frac{1}{2} \times 1 \frac{1}{4} \times 1 \frac{1}{4} \times 1 \frac{1}{4}$	† $2 \times \frac{1}{2}$	† $2 \times \frac{3}{4}$	2x1	2x1$\frac{1}{4}$	2x1$\frac{1}{2}$	
Class.....	D	D	C	D	D	D	D	
Each.....	\$0.74	.74	1.20	1.20	1.20	1.20	1.20	
Weight per 100, lbs....	170	154	178	198	228	254	270	

†BEADED BLACK CROSSES—2333-C.

Code.....	Rapinabas	Rapinador	Rapinante	Rapinaran	Rapineux	Rapingacho		
Size, inches.....	$\frac{3}{8}$	$\frac{1}{2}$	$\frac{3}{4}$	1	$1\frac{1}{4}$	$1\frac{1}{2}$		
Class.....	B	B	C	C	D	D		
Each.....	\$0.17	.23	.28	.39	.61	.74		
Weight per 100, lbs....	21	32	54	84	140	189		
Code.....		Rapinbar	Rapiquer	Rapiremo	Rapirono	Rapissimo		
Size, inches.....		2	$2\frac{1}{2}$	3	$3\frac{1}{2}$	4		
Class.....		D	D	D	D	D		
Each.....		\$1.20	2.50	3.00	5.00	6.00		
Weight per 100, lbs....		294	550	700	1050	1400		
Code.....		Rapistres	Rapitore	Rapitrice	Rapivate	Raploch	Rapointir	
Size, inches.....		$2\frac{1}{2} \times 1$	$2\frac{1}{2} \times 1\frac{1}{4}$	$2\frac{1}{2} \times 1\frac{1}{2}$	$2\frac{1}{2} \times 2$	$3 \times 1\frac{1}{4}$	$3 \times 1\frac{1}{2}$	
Class.....		D	D	D	D	D	D	
Each.....		\$2.50	2.50	2.50	2.50	3.00	3.00	
Weight per 100, lbs....		500	550	550	540	450	490	
Code.....			Raponchigo	Raponcos	Raponcule	Raponibus		
Size, inches.....			3x1	3x2	3x2$\frac{1}{2}$	4x2$\frac{1}{2}$		
Class.....			D	D	D	D		
Each.....			\$3.00	3.00	3.00	6.00		
Weight per 100, lbs....			500	500	700	1400		

†PLAIN GALVANIZED CROSSES—2332-C.

Code.....	Rapontico	Rapparato	Rapparo	Rappelait	Rappelig	Rappiccola	Rappiglia	Rappists	Rapport
Size, inches.....	$\frac{3}{8}$	$\frac{1}{2}$	$\frac{3}{4}$	1	$1\frac{1}{4}$	$1\frac{1}{2}$	2	$2\frac{1}{2}$	3
Class.....	B	B	C	C	D	D	D	D	D
Each.....	\$0.23	.32	.42	.58	.96	1.15	1.80	4.00	5.00
Weight per 100, lbs....	21	30	58	80	150	180	280	600	800

†Carried in San Francisco only.

In Orders and Specifications give Plate Numbers and Sizes.

MALLEABLE REDUCING COUPLINGS.



2336-C.
Plain.



2337-C.
Beaded.



†2338-C.
Offset.

PLAIN BLACK REDUCERS—2336-C.

Code.....	Rappozzi	Rapsabar	Rapsabo	Rapsamus	Rapsaret			
Size, inches.....	† $\frac{1}{4} \times \frac{1}{8}$	† $\frac{3}{8} \times \frac{1}{8}$	$\frac{3}{8} \times \frac{1}{4}$	† $\frac{1}{2} \times \frac{1}{4}$	$\frac{1}{2} \times \frac{3}{8}$			
Class.....	A	A	B	B	B			
Each.....	\$0.10	.15	.15	.17	.17			
Weight per 100, lbs.....	6	12	12	14	15			
Code.....	Rapsen	Rapsfeld	Rapsitabo	Rapsitamus				
Size, inches.....	† $\frac{3}{4} \times \frac{1}{4}$	$\frac{3}{4} \times \frac{3}{8}$	$\frac{3}{4} \times \frac{1}{2}$	† $1 \times \frac{3}{8}$				
Class.....	B	B	C	C				
Each.....	\$0.19	.19	.19	.22				
Weight per 100, lbs.....	22	20	21	38				
Code.....	Rapsitaret	Rapsmark	Rapsodia	Rapsodista	Rapswasser			
Size, inches.....	$1 \times \frac{1}{2}$	$1 \times \frac{3}{4}$	† $1 \frac{1}{4} \times \frac{1}{2}$	$1 \frac{1}{4} \times \frac{3}{4}$	$1 \frac{1}{4} \times 1$			
Class.....	C	C	C	D	D			
Each.....	\$0.22	.22	.27	.27	.27			
Weight per 100, lbs.....	41	41	44	44	50			
Code.....	Rapszeit	Raptando	Raptatura	Raptemur	Raptoras			
Size, inches.....	† $1 \frac{1}{2} \times \frac{1}{2}$	$1 \frac{1}{2} \times \frac{3}{4}$	$1 \frac{1}{2} \times 1$	$1 \frac{1}{2} \times 1 \frac{1}{4}$	$1 \frac{1}{2} \times \frac{3}{8}$			
Class.....	C	D	D	D	C			
Each.....	\$0.32	.32	.32	.32	.32			
Weight per 100, lbs.....	68	64	70	72	70			
Code.....	Raptorem	Raptorial	Rapturist	Rapturize	Rapuglio	Rapulati	Rapulatos	Rapulatum
Size, inches.....	† $2 \times \frac{1}{2}$	$2 \times \frac{3}{4}$	2×1	$2 \times 1 \frac{1}{4}$	$2 \times 1 \frac{1}{2}$	$2 \frac{1}{2} \times 2$	3×2	$3 \times 2 \frac{1}{2}$
Class.....	C	D	D	D	D	D	D	D
Each.....	\$0.55	.55	.55	.55	.55	.90	1.50	1.50
Weight per 100, lbs.....	129	125	118	122	125	175	234 $\frac{1}{2}$	250

BEADED BLACK REDUCERS—2337-C.

Code.....	Rapuncio	Rapunzel	Rapuroir	Raqueras	Raquetier	Raqueidos
Size, inches.....	† $1 \frac{1}{4} \times 1$	† $3 \frac{1}{2} \times 3$	† 4×2	$4 \times 2 \frac{1}{2}$	4×3	† $4 \times 3 \frac{1}{2}$
Class.....	D	D	D	D	D	D
Each.....	\$0.27	2.00	2.50	2.50	2.50	2.50
Weight per 100, lbs.....	60	450	570	590	552	550

PLAIN GALVANIZED REDUCERS—2336-C.

Code.....	Rarebit	Rareeshow	Rarefactif	Rarefazer	Rarefier	Rarekiek	Rareness
Size, inches.....	† $\frac{3}{8} \times \frac{1}{4}$	$\frac{1}{2} \times \frac{3}{8}$	$\frac{3}{4} \times \frac{1}{2}$	$1 \times \frac{3}{4}$	$1 \frac{1}{4} \times 1$	$1 \frac{1}{2} \times 1 \frac{1}{4}$	$2 \times 1 \frac{1}{2}$
Class.....	B	B	C	C	D	D	D
Each.....	\$0.18	.20	.25	.32	.40	.50	.85
Weight per 100, lbs.....	12	16	22	43	53	75	130

†BLACK OFFSET REDUCERS, MALE AND FEMALE.

Code.....	Rarescence	Rarescendo	Rarescent	Rarescible	Rarescimous
Size, inches.....	$1 \times \frac{3}{4}$	$1 \frac{1}{4} \times 1$	$1 \frac{1}{2} \times 1 \frac{1}{4}$	$2 \times 1 \frac{1}{2}$	$2 \frac{1}{2} \times 2$
Each.....	\$0.60	.70	.90	1.10	1.80
Weight per 100, lbs.....	38	70	75	100	140

†Carried in San Francisco only.

In Orders and Specifications give Plate Numbers and Sizes.

MALLEABLE COUPLINGS.



2341-C.
Plain Malleable.

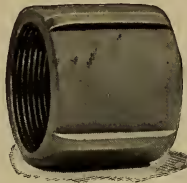

2342-C.
Right and Left—Malleable.

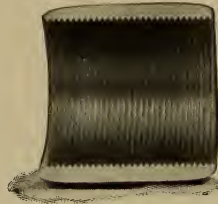

2343-C.
Plain Wrought.

PLAIN BLACK MALLEABLE COUPLINGS—2341-C.

Code	Rarete	Rarezas	Raridade	Rarifico	Rarifloros
Size, inches.....	1/8	1/4	3/8	1/2	3/4
Class	A	B	B	C	C
Each	\$0.08	.08	.09	.12	.16
Weight per 100, lbs	3	6	10	15	30
Code	Rarifolie	Rarifile	Rarifilum	Rarifilisse	Rarifitidine
Size, inches.....	1	1 1/4	1 1/2	2	2 1/2
Class	D	D	E	E	E
Each	\$0.22	.30	.40	.55
Weight per 100, lbs.....	50	70	80	140	250

PLAIN GALVANIZED MALLEABLE COUPLINGS—2341-C.

Code.....	Raritudo	Rarity	Rarosch	Rasabais	Rasados	Rasaminis	Rasbutos	Rascadura
Size, inches.....	1/4	3/8	1/2	3/4	1	1 1/4	1 1/2	2
Class.....	B	B	C	C	D	D	E	E
Each.....	\$0.10	.12	.17	.23	.34	.48	.53	.87
Weight per 100, lbs	7	11	16	32	53	75	90	150

RIGHT AND LEFT BLACK MALLEABLE COUPLINGS—2342-C.

Code.....	Rascaldom	Rascalism	Rascamono	Rascareis	Rascazon	Rascheln	Raschheit
Size, inches.....	3/8	1/2	3/4	1	1 1/4	1 1/2	2
Class.....	B	C	C	D	D	D	D
Each.....	\$0.16	.18	.20	.29	.52	.57	.80
Weight per 100, lbs ...	16	23	32	55	100	110	150

†RIGHT AND LEFT GALVANIZED MALLEABLE COUPLINGS—2342-C.

Code.....	Raschiollo	Rascunhar	Rasenbahn	Rasenbank	Rasengrund	Rasenleger
Size, inches	1/2	3/4	1	1 1/4	1 1/2	2
Class.....	C	C	D	D	D	D
Each.....	\$0.26	.30	.46	.85	.92	1.25
Weight per 100, lbs	25	35	60	110	120	160

BLACK WROUGHT COUPLINGS—2343-C.

Code.....	Rasenmal	Rasenplan	Rasenplatz	Rasenrain	Rasensitz	Rasentassi
Size, inches.....	1/4	3/8	1/2	3/4	1	1 1/4
Each.....	\$0.05	.06	.07	.10	.13	.17
Weight per 100, lbs.....	8 3/4	11 1/4	15	25	40	55
Code	Rasentato	Rasentavo	Rasentorf	Rasengeweg	Rasears	
Size, inches.....	1 1/2	2	2 1/2	3	4	
Each	\$0.21	.28	.40	.60	1.00	
Weight per 100, lbs.....	82 1/2	130	183 3/4	290	350	

†GALVANIZED WROUGHT COUPLINGS—2343-C.

Code.....	Rasgado	Rasgarias	Rasgunada	Rasgunaras	Rasgunos	Rasblings
Size, inches.....	1/4	3/8	1/2	3/4	1	1 1/4
Each.....	\$0.06	.08	.10	.13	.18	.25
Weight per 100, lbs	8 3/4	11 1/4	15	25	40	55
Code	Rashness	Rasilibus	Rasiliium	Rasimus	Rasisset	
Size, inches.....	1 1/2	2	2 1/2	3	4	
Each.....	\$0.32	.40	.55	.80	1.40	
Weight per 100, lbs.....	82 1/2	130	183 3/4	290	350	

†Carried in San Francisco only.

In Orders and Specifications give Plate Numbers and Sizes.

MALLEABLE RETURN BENDS.



† 2346-C.
Close Pattern—Banded.



† 2347-C.
Open Pattern—Banded.



2348-C.
Close Pattern—Plain.

† BLACK BANDED CLOSE PATTERN RETURN BENDS—2346-C.

Code.....	Rasitabis	Rasitatos	Rasitavit	Rasoribus	Rasourar	Raspadillo	Raspailar
Size, inches.....	3/8	1/2	3/4	1	1 1/4	1 1/2	2
Between Centers, inches...	7/8	1 1/4	1 3/4	1 3/4	2 1/8	2 1/2	3
Class.....	B	B	C	C	D	D	D
Each.....	\$0.25	.35	.45	.70	.95	1.30	2.00
Weight per 100, lbs.....	25	30	70	112	180	233	375

† BLACK BANDED OPEN PATTERN RETURN BENDS—2347-C.

Code.....	Raspajo	Raspantes	Raspaseis	Raspatino	Raspavano	Raspberry
Size, inches.....	1/2	3/4	1	1 1/4	1 1/2	2
Between Centers, inches...	1 1/2	2	2 1/2	3	3 1/2	4 1/2
Class.....	B	C	C	D	D	D
Each.....	\$0.45	.50	.80	1.00	1.50	3.50
Weight per 100, lbs.....	45	80	130	190	225	450

† GALVANIZED BANDED OPEN PATTERN RETURN BENDS—2347-C.

Code.....	Raspeando	Raspebrot	Raspe-span	Rasphuis	Raspiano
Size, inches.....	3/4	1	1 1/4	1 1/2	2
Between Centers, inches...	2	2 1/2	3	3 1/2	4 1/2
Class.....	C	C	D	D	D
Each.....	\$0.75	1.20	1.50	2.25	5.00
Weight per 100, lbs.....	84	130	200	280	460

PLAIN BLACK CLOSE PATTERN RETURN BENDS—2348-C.

Code.....	Raspilha	Raspzaag	Rasqueta
Size, inches.....	1/2	3/4	1
Between Centers, inches...	1	1 1/4	1 1/2
Class.....	B	C	C
Each.....	\$0.35	.40	.50
Weight per 100, lbs.....	32	50	80

† PLAIN GALVANIZED CLOSE PATTERN RETURN BENDS—2348-C.

Code.....	Rassaggia	Rassalisse	Rassaltano	Rassaltare
Size, inches.....	1/2	3/4	1	1 Right and Left.
Between Centers, inches...	1	1 1/4	1 1/2	1 1/2
Class.....	B	C	C	B
Each.....	\$0.52	.60	.75	1.10
Weight per 100, lbs.....	40	55	85	85

† Carried in San Francisco only.

In Orders and Specifications give Plate Numbers and Sizes.

MALLEABLE RETURN BENDS.



2349-C.

Close Pattern—Beaded.



2350-C.

Open Pattern—Beaded.

BEADED BLACK OPEN PATTERN RETURN BENDS—2350-C.

Code.....	Rassalto	Rassapora
Size, inches.....	¾	1
Between Centers, inches.....	2	2½
Class.....	C	C
Each.....	\$0.50	.80
Weight per 100, lbs.	80	130

† **BEADED GALVANIZED OPEN PATTERN RETURN BENDS—2350-C.**

Code.....	Rassasiant	Rassegando	Rassegare	Rassegato
Size, inches.....	1	1¼	1½	2
Between Centers, inches.....	2½	3	3½	4
Class.....	C	D	D	D
Each.....	\$1.20	1.50	2.25	4.00
Weight per 100, lbs.....	130	200	280	420

BEADED BLACK CLOSE PATTERN RETURN BENDS—2349-C.

Code.....	Rasselmaus	Rasselwerk	Rassembleur	Rassembrà	Rassicura	Rassigner
Size, inches.....	1½	1¾	1	1¼	1½	2
Between Centers, inches.....	1¼	1½	1¾	2¼	2½	3¼
Class.....	B	C	C	D	D	D
Each.....	\$0.40	.45	.60	.80	1.30	2.00
Weight per 100, lbs.....	40	60	90	150	210	400

BEADED BLACK CLOSE PATTERN RETURN BENDS, RIGHT AND LEFT—2349-C.

Code.....	Rassodarla
Size, inches.....	†1
Between Centers, inches.....	1¾
Class.....	B
Each.....	\$0.85
Weight per 100, lbs.....	90

† **BEADED GALVANIZED CLOSE PATTERN RETURN BENDS—2349-C.**

Code.....	Rassodasse	Rassodata	Rassodero	Rassodolla	Rassomare
Size, inches.....	¾	1	1¼	1½	2
Between Centers, inches.....	1½	1¾	2¼	2½	3¼
Class.....	C	C	D	D	D
Each.....	\$0.70	.90	1.20	1.95	3.25
Weight per 100, lbs.....	60	95	155	210	400

BEADED BLACK MEDIUM PATTERN RETURN BENDS. (Not shown)

Code.....	Rassurant	Rassurons
Size, inches.....	¾	†¾ Right and Left.
Between Centers, inches.....	1¼	1¾
Class.....	C	B
Each.....	\$0.45	.65
Weight per 100, lbs.....	60	60

†Carried in San Francisco only.

In Orders and Specifications give Plate Numbers and Sizes.

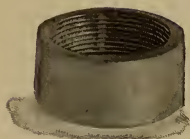

2352-C.
Plain Cap.



2353-C.
Square Head Cap.



2354-C.
Extension Piece.

PLAIN BLACK CAPS—2352-C.

Code.....	Rastejar	Rastellite	Rastiarla	Rastiolla	Rastlager
Size, inches.....	1/8	1/4	3/8	1/2	3/4
Class.....	A	B	B	C	C
Each.....	\$0.07	.07	.08	.11	.14
Weight per 100, lbs.....	4	5	10	15	25

Code.....	Rastloser	Rastolhal	Rastolyte	Rastorten	Rastrallo
Size, inches.....	1	1 1/4	1 1/2	2	2 1/2
Class.....	C	D	D	D	D
Each.....	\$0.17	.26	.33	.44	1.00
Weight per 100, lbs.....	33	60	75	100	200

PLAIN GALVANIZED CAPS—2352-C.

Code.....	Rastrejar	Rastrojo	Rastrop	Rasttag	Rasttagen
Size, inches.....	1/4	3/8	1/2	3/4	1
Class.....	B	B	C	C	C
Each.....	\$0.10	.12	.16	.20	.25
Weight per 100, lbs.....	6	11	16	27	35

Code.....	Rasuracion	Rasuramos	Rasuraste	Ratably	Rataconer
Size, inches.....	1 1/4	1 1/2	2	†2 1/2	†3
Class.....	D	D	D	D	D
Each.....	\$0.40	.50	.68	1.60	2.30
Weight per 100, lbs.....	64	80	106	210	300

PLAIN SQUARE HEAD BLACK CAPS—2353-C.

Code.....	Rataplán	Ratapoil	Ratazana
Size, inches.....	3	†3 1/2	4
Class.....	D	D	D
Each.....	\$1.50	2.00	3.00
Weight per 100, lbs.....	265	350	540

BLACK EXTENSION PIECES—2354-C.

Code.....	Ratelait	Ratelkous	Ratelmond	Ratelons	Ratenloos	Ratepayer	Rathbar
Size, inches.....	†3/8	1/2	3/4	†1	†1 1/4	†1 1/2	†2
Class.....	B	B	C	C	C	C	C
Each.....	\$0.10	.20	.21	.22
Weight per 100, lbs.....	9	20	28	34	70	100	120

GALVANIZED EXTENSION PIECES—2354-C.

Code.....	Rathgeber	Rathhaus	Rathripe	Rathsam
Size, inches.....	†3/8	1/2	3/4	†1
Class.....	B	B	C	C
Each.....	\$0.13	.28	.31	.35
Weight per 100, lbs.....	10	22	30	40

†Carried in San Francisco only.

In Orders and Specifications give Plate Numbers and Sizes.



2357-C.

Lock-nuts,
Showing both Faces.

2358-C.

†2359-C.

Female Chandelier Hook.

2360-C.

Offset.

BLACK LOCK-NUTS—2357-C.

Code.....	Rathsbote	Rathsherr	Rathstagen	Rathswahl	Rathumus	Rathymes	Ratifiers	Ratigada
Size, inches.....	1/8	1/4	3/8	1/2	3/4	1	1 1/4	1 1/2
Class.....	A	B	B	B	C	C	C	D
Each.....	\$0.06	.06	.06	.07	.10	.12	.17	.20
Weight per 100, lbs....	3	4	5	8	18	24	32	44

Code.....	Ratiguen	Ratillon	Ratineuse	Rational	Rationary
Size, inches.....	2	2 1/2	3	†3 1/2	4
Class.....	D	D	D	D	D
Each.....	\$0.33	.60	.75	1.10	1.25
Weight per 100, lbs.....	75	140	170	250	280

GALVANIZED LOCK-NUTS—2357-C.

Code.....	Rationell	Rationnes	Ratissage	Ratline	Ratmara	Ratoncules	Ratonescas
Size, inches.....	†1/4	†3/8	1/2	3/4	1	1 1/4	1 1/2
Class.....	B	B	B	C	C	C	D
Each.....	\$0.09	.09	.10	.15	.18	.26	.32
Weight per 100, lbs.....	5	6	9	20	25	35	50

Code.....	Ratonice	Ratooned	Ratouwen	Ratsbane	Rattaches
Size, inches.....	2	†2 1/2	†3	†3 1/2	†4
Class.....	D	D	D	D	D
Each.....	\$0.50	1.00	1.20	1.70	2.00
Weight per 100, lbs.....	80	147	180	260	300

†BLACK CHANDELIER HOOKS, FEMALE.

Code.....	Rattarpano	Rattarpo
Size, inches.....	3/8	1/2
Class.....	B	B
Each.....	\$0.20	.30
Weight per 100, lbs.....	20	30

PLAIN BLACK OFFSETS.

Code.....	Rattenknip	Rattenloch
Size, inches.....	3/4	†1
Center to Center, inches.....	1 1/2	2 1/2
Class.....	C	C
Each.....	\$0.50	.70
Weight per 100, lbs.....	65	110

†Carried in San Francisco only.

In Orders and Specifications give Plate Numbers and Sizes.



2362-C.
Waste Nuts.

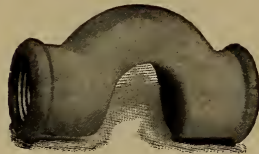

† **2363-C.**
Cross-Overs.



† **2364-C.**
Hydrant Clamps.

BLACK WASTE NUTS—2362-C.

Code.....	Rattentod	Rattenuta	Rattenvolk	Rattenzahn	Rattlewort
Size, inches.....	† ¼	⅜	½	¾	1
Class.....	B	B	B	B	C
Each.....	\$0.08	.09	.11	.14	.17
Weight per 100, lbs.....	6	9	10	14	20

TINNED WASTE NUTS—2362-C.

Code.....	Rattoppo	Rattornia	Rattorzola	Rattostilo	Ratraggo
Size, inches.....	† ¼	⅜	½	¾	1
Class.....	B	B	B	B	C
Each.....	\$0.12	.13	.15	.20	.25
Weight per 100, lbs.....	6	10	11	15	21

† **GALVANIZED CROSS-OVERS—2363-C.**

Code.....	Ratrapes	Ratrista	Rattulo
Size, inches.....	¾	¾	1
Crosses pipe, inches.....	¾	1	1
Each.....	\$0.32	.50	.49
Weight per 100, lbs.....	106	110	115

† **BLACK HYDRANT CLAMPS FOR PIPE—2364-C.**

Code.....	Ratumena
Tapped for pipe, inch.....	¾
Each.....	\$0.10
Weight per 100, lbs.....	30

ASPHALTUM DIPPED FITTINGS.

We can furnish any fittings shown in this catalogue dipped to order.

Prices on application.

† Carried in San Francisco only.

In Orders and Specifications give Plate Numbers and Sizes.

CIRCULATING BOILER FITTINGS.



2368-C.
Boiler Elbows.

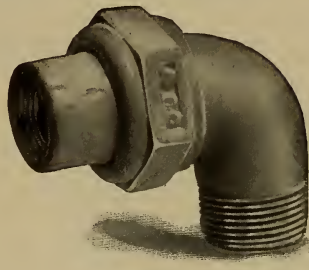

2369-C.
Union Boiler Elbows.

GALVANIZED BOILER ELBOWS—2368-C.

Code.....	Raturait	Ratureras
Size, inches.....	* $\frac{3}{4} \times \frac{1}{2} \times \frac{3}{4}$	** $1 \times \frac{3}{4} \times \frac{3}{4}$
Each.....	\$0.15	.15
Weight per 100, lbs.....	45	42½
* Male end Threaded $\frac{3}{4}$ -inch and Tapped $\frac{1}{2}$ -inch; Outlet Tapped $\frac{3}{4}$ -inch.		
** Male " " 1 " " " $\frac{3}{4}$ " " " $\frac{3}{4}$ " "		

GALVANIZED UNION BOILER ELBOWS—2369-C.

Code.....	Raubadel	Raubbau
Size, inches.....	* $1 \times \frac{1}{2} \times \frac{3}{4}$	** $1 \times \frac{3}{4} \times \frac{3}{4}$
Each.....	\$0.45	.45
Weight per 100, lbs.....	98	96
* Male end Threaded 1-inch and Tapped $\frac{1}{2}$ -inch with $\frac{3}{4}$ -inch Union.		
** Male " " 1 " " " $\frac{3}{4}$ " " " $\frac{3}{4}$ " " "		

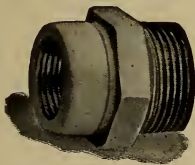

2370-C.
Hexagon Boiler Socket.

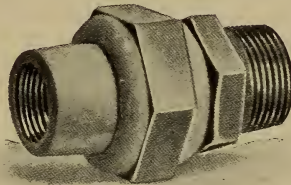

2371-C.
Union Boiler Socket.

GALVANIZED HEXAGON BOILER SOCKETS—2370-C.

Code.....	Raubfisch	Raubfuss	Raubgut
Size, inches.....	* $1 \times \frac{1}{2} \times \frac{3}{4}$	** $1 \times \frac{3}{4} \times \frac{3}{4}$	** * $1 \times \frac{1}{2} \times \frac{1}{2}$
Each.....	\$0.15	.15	.15
Weight per 100, lbs.....	35	30	32½
* Male end Threaded 1-inch and Tapped $\frac{1}{2}$ -inch; Outlet Tapped $\frac{3}{4}$ -inch.			
** Male " " 1 " " " $\frac{3}{4}$ " " " $\frac{3}{4}$ " "			
* * Male " " 1 " " " $\frac{1}{2}$ " " " $\frac{1}{2}$ " "			

GALVANIZED UNION BOILER SOCKETS—2371-C.

Code.....	Raubkrieg	Raubleben	Raubmahl
Size, inches.....	* $1 \times \frac{1}{2} \times \frac{3}{4}$	** $1 \times \frac{3}{4} \times \frac{3}{4}$	** * $1 \times \frac{1}{2} \times \frac{1}{2}$
Each.....	\$0.45	.45	.40
Weight per hundred, lbs.....	80	75	77
* Male end Threaded 1-inch and Tapped $\frac{1}{2}$ -inch with $\frac{3}{4}$ -inch Union.			
** Male " " 1 " " " $\frac{3}{4}$ " " " $\frac{3}{4}$ " "			
* * Male " " 1 " " " $\frac{1}{2}$ " " " $\frac{1}{2}$ " "			

In Orders and Specifications give Plate Numbers and Sizes.

UNION ELBOWS.



2374-C.

With Female Sleeve.



2375-C.

With Male Sleeve.

† **BLACK UNION ELBOWS WITH FEMALE SLEEVE—2374-C.**

Code.....	Raubmaus	Raubmord	Raubnest	Raubpfahl	Raubrecht	Raubritt
Size, inches.....	½	¾	1	1¼	1½	2
Each.....	\$0.42	.54	.63	.90	1.05	1.55
Weight per 100, lbs.....	49	80¼	116	190	262	384

GALVANIZED UNION ELBOWS WITH FEMALE SLEEVE—2374-C.

Code.....	Raubschiff	Raubstaat	Raubsucht	Raubsystem	Raubthier	Raubvogel
Size, inches.....	†½	¾	†1	†1¼	†1½	†2
Each.....	\$0.63	.81	.95	1.35	1.58	2.35
Weight per 100, lbs.....	49	80¼	116	190	262	384

† **BLACK UNION ELBOWS WITH MALE SLEEVE—2375-C.**

Code.....	Raubvolk	Raubwespen	Raubwild	Raubwolf	Raubzuegen	Raubzug
Size, inches.....	½	¾	1	1¼	1½	2
Each.....	\$0.48	.62	.72	1.05	1.20	1.80
Weight per 100, lbs.....	65	88¾	128¾	211¼	282	410½

GALVANIZED UNION ELBOWS WITH MALE SLEEVE—2375-C.

Code.....	Raucabar	Raucabo	Raucabunt	Raucamente	Raucavero	Raucavisti
Size, inches.....	†½	¾	†1	†1¼	†1½	†2
Each.....	\$0.72	.93	1.08	1.60	1.80	2.70
Weight per 100, lbs.....	65	88¾	128¾	211¼	282	410½

†Carried in San Francisco only.

In Orders and Specifications give Plate Numbers and Sizes.

UNION TEES.



2378-C.

With Female Sleeve.



2379-C.

With Male Sleeve.

†BLACK UNION TEES WITH FEMALE SLEEVE—2378-C.

Code	Raucedinem	Raucedinis	Raucedo	Raucemus	Raucesco	Raucescunt
Size, inches	½	¾	1	1¼	1½	2
Each	\$0.45	.57	.70	.95	1.15	1.70
Weight per 100, lbs.....	55½	87	135	216	304	444

GALVANIZED UNION TEES WITH FEMALE SLEEVE—2378-C.

Code	Rauchabzug	Rauchaltar	Rauchdicht	Rauchender	Rauchfahne	Rauchfang
Size, inches	†½	¾	†1	†1¼	†1½	†2
Each	\$0.68	.86	1.05	1.45	1.75	2.55
Weight per 100, lbs.....	55½	87	135	216	304	444

†BLACK UNION TEES WITH MALE SLEEVE—2379-C.

Code.....	Rauchgarbe	Rauchgelb	Rauchgluth	Rauchgrau	Rauchhafer	Rauchholz
Size, inches.....	½	¾	1	1¼	1½	2
Each	\$0.52	.65	.80	1.10	1.30	1.95
Weight per 100, lbs	62	96¼	148¾	236	323½	470

GALVANIZED UNION TEES, MALE SLEEVE—2379-C.

Code.....	Rauchkoble	Rauchkopf	Rauchkugel	Rauchleder	Rauchlock	Rauchlokal
Size, inches.....	†½	¾	†1	†1¼	†1½	†2
Each	\$0.78	1.00	1.20	1.65	1.95	2.95
Weight per 100, lbs.....	62	96¼	148¾	236	323½	470

†Carried in San Francisco only.

In Orders and Specifications give Plate Numbers and Sizes.

MALLEABLE UNIONS.



2382-C.
Standard.

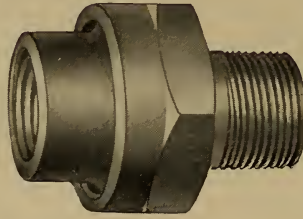

2383-C.
Male and Female.

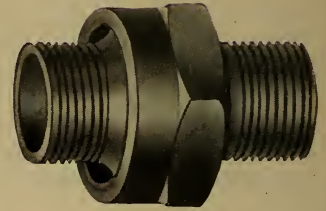

2384-C.
Male.

BLACK UNIONS—2382-C.

Code.....	Rauchnest	Rauchhobel	Rauchopfer	Rauchqualm	Rauchrohr	Rauchstaub	Rauchstube
Size, inches.....	1/8	1/4	3/8	1/2	3/4	1	1 1/4
Each.....	\$0.18	.18	.20	.22	.27	.33	.46
Weight per 100, lbs.....	7	15	22	33	57	80	122
Code.....	Rauchtabak	Rauchton	Rauchtopas	Rauchwerk	Rauchwolke	Rauchzunge	
Size, inches.....	1 1/2	2	2 1/2	3	†3 1/2	4	
Each.....	\$0.58	.75	1.55	2.10	3.65	4.35	
Weight per 100, lbs.....	176	242	385	530	692	843	

GALVANIZED UNIONS—2382-C.

Code.....	Rauciamus	Raucidule	Raucidulos	Raucidulum	Rauciebat	Raucisona	Raucous
Size, inches.....	†1/8	1/4	3/8	1/2	3/4	1	1 1/4
Each.....	\$0.27	.27	.30	.33	.40	.50	.70
Weight per 100, lbs.....	7	15	22	33	57	80	122
Code.....	Raudales	Raudanite	Rauderibus	Raudiva	Rauduscula	Raufbold	
Size, inches.....	1 1/2	2	†2 1/2	†3	†3 1/2	†4	
Each.....	\$0.90	1.15	2.35	3.15	5.50	6.50	
Weight per 100, lbs.....	176	242	385	530	692	843	

† GALVANIZED MALE AND FEMALE UNIONS—2383-C.

Code.....	Raufen	Raufhandel	Raufstüg
Size, inches.....	1/2	3/4	1
Each.....	\$0.40	.48	.60
Weight per 100, lbs.....

† GALVANIZED MALE UNIONS—2384-C.

Code.....	Raufmesser	Raufwinkel	Raugraefin
Size, inches.....	1/2	3/4	1
Each.....	\$0.40	.48	.60
Weight per 100, lbs.....

† Carried in San Francisco only.

In Orders and Specifications give Plate Numbers and Sizes.

MALLEABLE UNIONS.

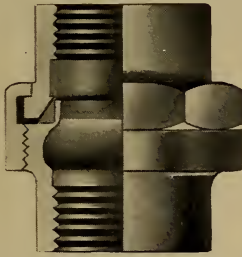

2387-C.
National.

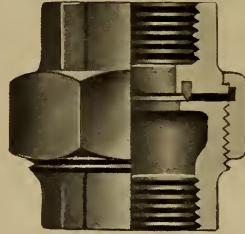

2388-C.
Erie.

*** BLACK IMPROVED NATIONAL UNIONS—2387-C.**

Code.....	Rauhbank	Rauhbart	Rauherten	Raufelsig	Rauhrost
Size, inches.....	†¼	†¾	½	¾	1
Each.....	\$0.20	.24	.28	.35	.40
Weight per 100, lbs.....	15	20	35	60	90

Code.....	Rauhigkeit	Raumlinde	Rauhkalk	Rauhkorn	Raummauer
Size, inches.....	†1¼	†1½	†2	†2½	†3
Each.....	\$0.56	.80	.95	2.00	2.75
Weight per 100, lbs.....	140	190	270	430	540

*** GALVANIZED IMPROVED NATIONAL UNIONS—2387-C.**

Code.....	Rauhreifen	Rauhstein	Rauhwacke	Raumlim	Raumanker
Size, inches.....	†¼	†¾	½	¾	1
Each.....	\$0.24	.28	.35	.46	.55
Weight per 100, lbs.....	15	20	35	60	90

Code.....	Raumbett	Raumbobrer	Raumeisen	Raumihano	Raumiliare
Size, inches.....	1¼	1½	†2	†2½	†3
Each.....	\$0.78	1.12	1.35	2.90	3.75
Weight per 100, lbs.....	140	190	270	430	540

*National Unions have a ring of Anti-corrosive metal as shown in sectional cut above.

† BLACK ERIE UNIONS—2388-C.

WITH COPPER PACKING.

Code.....	Raumliava	Raumilio	Rauminhalt	Raumite	Raumlaenge	Raummeter
Size, inches.....	¼	¾	½	¾	1	1¼
Each.....	\$0.20	.24	.28	.35	.40	.56
Weight per 100, lbs.....	10	30	50	80	100	162½

Code.....	Raumnadel	Raumweite	Raunata	Rauncinato	Raupe
Size, inches.....	1½	2	2½	3	4
Each.....	\$0.80	.95	2.00	2.75	5.00
Weight per 100, lbs.....	200	320	540	750

†Carried in San Francisco only.

In Orders and Specifications give Plate Numbers and Sizes.

BUSHINGS.

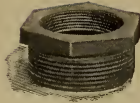

2391-C.

Style of Regular Sizes.

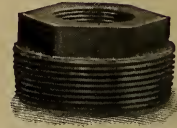

2394-C.

Style of Odd Sizes.

BLACK BUSHINGS.

Code.....	Raupennest	Raupenvolk	Raupig	Rauquant	Rauque	Rauracorum	Rauracos	Raurarum	Rauschen
Size, inches.....	* $\frac{1}{4} \times \frac{1}{8}$	* $\frac{3}{8} \times \frac{1}{8}$	* $\frac{3}{8} \times \frac{1}{4}$	$\frac{1}{2} \times \frac{1}{8}$	$\frac{1}{2} \times \frac{1}{4}$	* $\frac{1}{2} \times \frac{3}{8}$	$\frac{3}{4} \times \frac{1}{4}$	$\frac{3}{4} \times \frac{3}{8}$	* $\frac{3}{4} \times \frac{1}{2}$
Each.....	\$0.04	.04	.04	.04	.04	.04	.05	.05	.05
Weight per 100, lbs.	1 $\frac{1}{4}$	3	2 $\frac{1}{2}$	6	6	4 $\frac{1}{4}$	10	10	7

Code.....	Rauschgold	Rauschkorn	Rauseramus	Rausimus	Rausisset	Rausso	Rautenglas	Rautenoel	Rautmast
Size, inches.....	1x$\frac{1}{4}$	1x$\frac{3}{8}$	1x$\frac{1}{2}$	* 1x$\frac{3}{4}$	1$\frac{1}{4}$ x $\frac{3}{8}$	1$\frac{1}{4}$ x $\frac{1}{2}$	1$\frac{1}{4}$ x $\frac{3}{4}$	* 1$\frac{1}{4}$ x 1	1$\frac{1}{2}$ x $\frac{3}{8}$
Each.....	\$0.06	.06	.06	.06	.07	.07	.07	.07	.09
Weight per 100, lbs.	15 $\frac{3}{4}$	17	19	12	25	28 $\frac{3}{4}$	29 $\frac{3}{4}$	20	34 $\frac{1}{2}$

Code.....	Ravage	Ravageons	Ravageras	Ravageriez	Ravageront	Ravaging	Ravaghone	Ravailleac
Size, inches.....	1$\frac{1}{2}$ x $\frac{1}{2}$	1$\frac{1}{2}$ x $\frac{3}{4}$	1$\frac{1}{2}$ x 1	* 1$\frac{1}{2}$ x 1$\frac{1}{4}$	2x$\frac{3}{8}$	2x$\frac{1}{2}$	2x$\frac{3}{4}$	2x1
Each.....	\$0.09	.09	.09	.09	.14	.14	.14	.14
Weight per 100, lbs.	37 $\frac{1}{2}$	40 $\frac{3}{4}$	43 $\frac{3}{4}$	22	50	53 $\frac{1}{4}$	57 $\frac{3}{4}$	64

Code.....	Ravalement	Ravanese	Ravanger	Ravastello	Ravaudeur	Ravebek	Ravekop	Ravelijnen
Size, inches.....	2x1$\frac{1}{4}$	* 2x1$\frac{1}{2}$	2$\frac{1}{2}$ x $\frac{3}{4}$	2$\frac{1}{2}$ x 1	2$\frac{1}{2}$ x 1$\frac{1}{4}$	2$\frac{1}{2}$ x 1$\frac{1}{2}$	2$\frac{1}{2}$ x 2	3x$\frac{3}{4}$
Each.....	\$0.14	.14	.21	.21	.21	.21	.21	.30
Weight per 100, lbs.	50	45	81 $\frac{1}{4}$	87 $\frac{1}{2}$	87 $\frac{1}{2}$	90 $\frac{3}{4}$	65 $\frac{3}{4}$	131 $\frac{1}{4}$

Code.....	Ravelins	Ravelment	Ravenaard	Ravenaas	Ravenelle	Ravener	Ravening	Ravenkool
Size, inches.....	3x1	3x1$\frac{1}{4}$	3x1$\frac{1}{2}$	3x2	3x2$\frac{1}{2}$	3$\frac{1}{2}$ x 1$\frac{1}{2}$	3$\frac{1}{2}$ x 2	3$\frac{1}{2}$ x 2$\frac{1}{2}$
Each.....	\$0.30	.30	.30	.30	.30	.40	.40	.40
Weight per 100, lbs.	125	125	134 $\frac{1}{2}$	125	130	178 $\frac{1}{4}$	156 $\frac{1}{4}$	175

Code.....	Ravenkost	Ravennatem	Ravenesse	Ravenous	Ravensara	Ravenstone	Ravenzwart	Raverusto
Size, inches.....	3$\frac{1}{2}$ x 3	4x1$\frac{1}{2}$	4x2	4x2$\frac{1}{2}$	4x3	4x3$\frac{1}{2}$	5x4	6x5
Each.....	\$0.40	.50	.50	.50	.50	.50	.93	1.25
Weight per 100, lbs.	170	212 $\frac{1}{2}$	193 $\frac{3}{4}$	222	222	230	318 $\frac{3}{4}$	559 $\frac{1}{2}$

† GALVANIZED BUSHINGS.

Code.....	Ravevlerk	Raviceli	Ravicelos	Ravicelum	Raviebam	Raviebatis	Ravigotant
Size, inches.....	* $\frac{3}{8} \times \frac{1}{4}$	* $\frac{1}{2} \times \frac{3}{8}$	* $\frac{3}{4} \times \frac{1}{2}$	1x$\frac{3}{8}$	1x$\frac{1}{2}$	* 1x$\frac{3}{4}$	1$\frac{1}{4}$ x $\frac{3}{4}$
Each.....	\$0.08	.08	.10	.12	.12	.12	.14
Weight per 100, lbs.....		2 $\frac{1}{2}$	4 $\frac{1}{4}$	7	17	19	29 $\frac{3}{4}$

Code.....	Ravigote	Ravinala	Ravines	Ravirons	Ravisement	Ravissable	Ravissais
Size, inches.....	* 1$\frac{1}{4}$ x 1	1$\frac{1}{2}$ x 1	* 1$\frac{1}{2}$ x 1$\frac{1}{4}$	2x1$\frac{1}{4}$	* 2x1$\frac{1}{2}$	2$\frac{1}{2}$ x 2	3x2$\frac{1}{2}$
Each.....	\$0.14	.18	.18	.28	.28	.42	.60
Weight per 100, lbs.....		20	43 $\frac{3}{4}$	22	50	45	65 $\frac{3}{4}$

* Sizes marked with an asterisk are Malleable, all others are Grey Iron.

† Carried in San Francisco only.

In Orders and Specifications give Plate Numbers and Sizes.



2398-C.
Plugs.

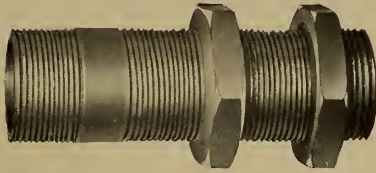

† **2399-C.**
Tank Lock Thread.

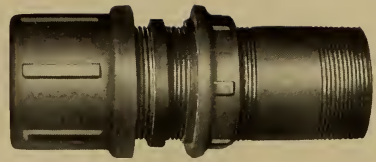

† **2400-C.**
American Long Screw.

BLACK PLUGS—2398-C.

Code.....	Ravissant	Ravisses	Ravisseur	Ravissons	Ravotten	Ravulorum	Ravulum	Ravvalora
Size, inches.....	1/8	1/4	3/8	1/2	3/4	1	1 1/4	1 1/2
Each.....	\$0.02	.02	.02	.02	.03	.04	.05	.07
Weight per 100, lbs.....	1 1/2	3 1/2	4 1/2	9	12 1/2	21	31	44
Code.....	Ravvelena	Ravviammo	Ravviando	Ravviarono	Ravviassi	Rivviavamo	Ravvicina	
Size, inches.....	2	2 1/2	3	†3 1/2	4	†5	†6	
Each.....	\$0.10	.18	.25	.38	.42	.88	1.20	
Weight per 100, lbs.....	61	80	140	180	228	456	602	

† **GALVANIZED PLUGS—2398-C.**

Code.....		Ravvierai	Ravvilirei	Ravviliro	Ravvilisci	Ravvilita	
Size, inches.....		1/4	3/8	1/2	3/4	1	
Each.....		\$0.04	.04	.04	.06	.08	
Weight per 100, lbs.....		3 1/2	4 1/2	9	12 1/2	21	
Code.....	Ravviluppa	Ravvincere	Ravvinco	Ravvio	Ravvisata	Ravvinceva	Rawbone
Size, inches.....	1 1/4	1 1/2	2	2 1/2	3	3 1/2	4
Each.....	\$0.10	.14	.20	.36	.50	.76	.84
Weight per 100, lbs.....	31	44	61	80	140	180	228

† **BLACK TANK LOCK THREADS—2399-C.**

6 inches long. With one Thread 4 inches long.

Code.....		Rawhead	Rawhides	Rawish	Rawly	Rayabamos	Rayaban
Size, inches.....		1/2	3/4	1	1 1/4	1 1/2	2
Each.....		\$0.65	.75	1.00	1.25	1.50	2.00
Weight per 100, lbs.....		55	80	130	170	190	315

† **GALVANIZED TANK LOCK THREADS—2399-C.**

6 inches long. With one Thread 4 inches long.

Code.....		Rayamos	Rayando	Rayar	Rayariamos	Rayarian	Rayaron
Size, inches.....		1/2	3/4	1	1 1/4	1 1/2	2
Each.....		\$0.98	1.13	1.50	1.88	2.25	3.00
Weight per 100, lbs.....		55	80	130	170	190	315

† **BLACK AMERICAN LONG SCREWS—2400-C.**

Require no Packing and make a Joint that will not Leak.

Code.....		Rayasteis	Raygras	Raymundo	Rayol	Rayonnage	Rayonnait
Size, inches.....		1/2	3/4	1	1 1/4	1 1/2	2
Length, inches { from.....		4	4	4 1/2	5	5	5
{ to.....		5 1/2	6	6	6 1/2	6 1/2	6 1/2
Each.....		\$0.40	.55	.75	1.00	1.30	1.70

† Carried in San Francisco only.

In Orders and Specifications give Plate Numbers and Sizes.



2405-C.
Close Nipple.



2406-C.
Shoulder Nipple.

BLACK WROUGHT NIPPLES.

Length in Inches.						Size Pipe.	Prices.		Length and Prices, Extra Long Nipples.											
Close.	Short.	Long.					Close or Short.	Long.	Inches.											
						4			5	6	7	8	9	10	11	12				
3/4	1 1/2	2	2 1/2	3	3 1/2	1/8	.04	.06	.07	.08	.10	.12	.14	.15	.17	.18	.19			
7/8	1 1/2	2	2 1/2	3	3 1/2	1/4	.04	.06	.07	.08	.10	.12	.14	.15	.17	.18	.19			
1	1 1/2	2	2 1/2	3	3 1/2	3/8	.04	.06	.07	.08	.10	.12	.14	.15	.17	.18	.19			
1 1/8	1 1/2	2	2 1/2	3	3 1/2	1/2	.05	.07	.08	.10	.12	.14	.16	.18	.20	.22	.23			
1 3/8	2	2 1/2	3	3 1/2	4	3/4	.06	.0911	.13	.17	.18	.20	.22	.24	.26			
1 1/2	2	2 1/2	3	3 1/2	4	1	.08	.1315	.18	.23	.25	.28	.31	.34	.36			
1 5/8	2 1/2	3	3 1/2	4	4 1/2	1 1/4	.11	.1720	.24	.29	.33	.36	.40	.44	.47			
1 3/4	2 1/2	3	3 1/2	4	4 1/2	1 1/2	.13	.2025	.29	.36	.40	.45	.50	.54	.59			
2	2 1/2	3	3 1/2	4	4 1/2	2	.18	.2732	.38	.50	.54	.59	.65	.72	.77			
2 1/2	3	3 1/2	4	4 1/2	5	2 1/2	.39	.5968	.90	.97	1.06	1.17	1.26	1.35				
2 1/2	3	3 1/2	4	4 1/2	5	3	.48	.7285	1.08	1.20	1.33	1.45	1.58	1.70				
2 3/4	4	4 1/2	5	5 1/2	6	3 1/2	.75	1.05	1.30	1.45	1.60	1.75	1.90	2.05				
3	4	4 1/2	5	5 1/2	6	4	.85	1.20	1.52	1.69	1.87	2.05	2.22	2.40				
3 1/2	4 1/2	5	5 1/2	6	6 1/2	5	1.55	2.45	2.58	2.83	3.10	3.35	3.60	3.85				
3 1/2	4 1/2	5	5 1/2	6	6 1/2	6	1.85	2.90	3.05	3.35	3.70	4.00	4.30	4.65				

For Telegraphic Code see next page.

GALVANIZED WROUGHT NIPPLES.

Length in Inches.						Size Pipe.	Prices.		Length and Prices, Extra Long Nipples.											
Close.	Short.	Long.					Close or Short.	Long.	Inches.											
						4			5	6	7	8	9	10	11	12				
3/4	1 1/2	2	2 1/2	3	3 1/2	1/8	.06	.11	.12	.15	.17	.21	.24	.26	.29	.31	.34			
7/8	1 1/2	2	2 1/2	3	3 1/2	1/4	.06	.11	.12	.15	.17	.21	.24	.26	.29	.31	.34			
1	1 1/2	2	2 1/2	3	3 1/2	3/8	.06	.11	.12	.15	.17	.21	.24	.26	.29	.31	.34			
1 1/8	1 1/2	2	2 1/2	3	3 1/2	1/2	.06	.11	.13	.16	.18	.23	.26	.28	.31	.33	.36			
1 3/8	2	2 1/2	3	3 1/2	4	3/4	.08	.1418	.21	.26	.29	.32	.35	.38	.41			
1 1/2	2	2 1/2	3	3 1/2	4	1	.11	.1924	.28	.34	.38	.42	.47	.51	.55			
1 5/8	2 1/2	3	3 1/2	4	4 1/2	1 1/4	.17	.2932	.38	.45	.51	.57	.63	.69	.75			
1 3/4	2 1/2	3	3 1/2	4	4 1/2	1 1/2	.21	.3539	.46	.55	.63	.70	.77	.84	.91			
2	2 1/2	3	3 1/2	4	4 1/2	2	.27	.4752	.61	.74	.83	.93	1.03	1.13	1.23			
2 1/2	3	3 1/2	4	4 1/2	5	2 1/2	.56	.86	1.00	1.26	1.41	1.56	1.71	1.86	2.01			
2 1/2	3	3 1/2	4	4 1/2	5	3	.70	1.10	1.30	1.60	1.80	2.00	2.20	2.40	2.60			
2 3/4	4	4 1/2	5	5 1/2	6	3 1/2	1.20	1.70	2.10	2.35	2.60	2.85	3.15	3.40			
3	4	4 1/2	5	5 1/2	6	4	1.35	1.87	2.30	2.60	2.90	3.20	3.50	3.80			

For Telegraphic Code see next page.

In Orders and Specifications give Plate Numbers and Sizes.

†RIGHT AND LEFT BLACK NIPPLES.

LENGTH IN INCHES.					Size Pipe.	PRICES.		Length and Prices, Extra Long Nipples.									
Close.	Short.	Long.				Close or Short.	Long.	Inches.									
								4	5	6	7	8	9	10	11	12	
1 1/8	1 1/2	2	2 1/2	3	3 1/2	1/2	.07		.11	.13	.16	.18	.21	.24	.27	.29	.31
1 3/8	2	2 1/2	3	3 1/2	4	3/4	.08	15	.17	.23	.25	.27	.29	.32	.35
1 1/2	2	2 1/2	3	3 1/2	4	1	.11	20	.24	.31	.33	.37	.41	.45	.48
1 5/8	2 1/2	3	3 1/2	4	4 1/2	1 1/4	.15	27	.32	.39	.45	.50	.55	.60	.65
1 3/4	2 1/2	3	3 1/2	4	4 1/2	1 1/2	.18	34	.39	.48	.52	.60	.67	.72	.80
2	2 1/2	3	3 1/2	4	4 1/2	2	.24	43	.51	.67	.72	.80	.87	.96	1.03

Add 60 per cent to above prices for Galvanized Nipples, Right and Left.

TELEGRAPHIC CODE FOR BLACK, GALVANIZED AND RIGHT AND LEFT NIPPLES.

Size Pipe, Inches.	BLACK.			GALVANIZED.			RIGHT AND LEFT, BLACK.		
	Close.	Short.	Long.	Close.	Short.	Long.	Close.	Short.	Long.
1/8	Rayonneur	Reaccusar ..	Readopted ..	Reagreed ...	Reanoint ...	Rearward...	Reasuntos ..	Rebalade...	Rebasadero
1/4	Rayons	Reachable ..	Readorn	Reagreeing ..	Reanswer ...	Reascend ...	Reattach.....	Rebalajes ..	Rebasando..
3/8	Rayosas	Reachless ...	Readorning ..	Reagudas ...	Reaper	Reasonable ..	Reattain	Rebaleur ...	Rebasaria ..
1/2	Rayuela.....	Readjust.....	Readunatio ..	Reagudo.....	Reappeared ..	Reasoned....	Reattempt ..	Rebalsados ..	Rebassiner..
3/4	Razadas	Reactively ..	Readvance ..	Realisable... ..	Reappellant ..	Reasonist....	Reavow	Rebalsamos ..	Rebatator ..
1	Razago	Reactive.....	Readying	Realistic	Reapplied ..	Reasonless..	Reawowing ..	Rebanhada ..	Rebate.....
1 1/4	Razaremos ..	Reactur.....	Reaffirm	Realist.....	Reapply.....	Reaspire	Reawake	Rebanhar ...	Rebatador ..
1 1/2	Razaren	Readably	Reafforest ..	Realize	Reappoint ..	Reassemble ..	Rebadilha ..	Rebannir ...	Rebatiamos ..
2	Razarias.....	Readiness ..	Reagenos.....	Realge	Reapposer ..	Reassert	Rebaigner ..	Rebannites ..	Rebatias....
2 1/2	Razeil	Readjournal ..	Reagebamus ..	Realliance ..	Reapproach ..	Reassign ...	Rebaissier ..	Rebanos....	Rebatieras ..
3	Rea bonnais ..	Readjust.....	Reagentios ..	Really	Reargue	Reassumir ..	Rebaixar ...	Rebatitiser ..	Rebatifront ..
3 1/2	Reabonne	Readmettre ..	Reagentien ..	Realm	Rearmement ..	Reassumed ..	Rebajadas ..	Rebaptise ..	Rebatistas ..
4	Reabonnons ..	Readmission ..	Reagentium ..	Realmente ..	Rearmost	Reasumidos ..	Rebajadi.....	Rebarbatif ..	Rebatiste ..
5	Reabsorber ..	Readmit	Reagravare ..	Reamless ...	Rearpenter ..	Reasuncion ..	Rebajarian ..	Rebardeur ..	Rebatosas ..
6	Reacciones ..	Readmitted ..	Reaggrave ..	Reannex	Rearrange ..	Reasunta....	Rebajaron ..	Rebasaban ..	Rebatososo ..

BLACK. EXTRA LONG.

Size Pipe, Inches.	4 Inches.	5 Inches.	6 Inches.	7 Inches.	8 Inches.	9 Inches.	10 Inches.	11 Inches.	12 Inches.
1/8	Rebattoir ...	Rebellibus ..	Rebenmost ..	Rebinaban ..	Reblessons..	Rebocino ...	Rebordao ...	Rebouche ...	Rebramases ..
1/4	Rebaudir	Rebellies ...	Rebenpfahl ..	Rebinador ..	Rebleuten... ..	Rebolaria ...	Rebordons ..	Rebours.....	Rebrameis ..
3/8	Rebberg	Rebellious ..	Rebenque ..	Rebinage ...	Reblincado ..	Rebolindo ..	Reborner... ..	Rebouteur ..	Rebrasser ..
1/2	Rebebe	Rebellisch ..	Rebenrauke ..	Rebinarian ..	Rebolipast ..	Rebolipast ..	Rebosada ...	Rebozado ...	Rebreathe ..
3/4	Rebebidas ..	Rebellow.....	Rebensorte ..	Rebinaste... ..	Reblinques ..	Rebolique... ..	Rebosadura ..	Rebozarono ..	Rebridant... ..
1	Rebebidos ..	Rebelona.....	Rebensniet ..	Rebinetio... ..	Reblooming ..	Rebolir	Rebosareis ..	Rebozes.....	Rebrodais ..
1 1/4	Rebeca	Rebenacker ..	Rebenstock ..	Rebitimus ..	Rebllossom ..	Rebollo	Rebotaban ..	Rebozo	Rebrodies ..
1 1/2	Rebeccaism ..	Rebenbaum ..	Rebentina ..	Rebitunt	Reboabamus ..	Rebulludo ..	Rebotacion ..	Rebpfahl	Rebrodons ..
2	Rebelaras ..	Rebencazo ..	Rebequez ..	Reblanchir ..	Reboabunt ..	Rebombar... ..	Rebotador ..	Rebraced ..	Rebrouille ..
2 1/2	Rebelde	Rebandoldes ..	Rebezos	Reblaubes ..	Reboation... ..	Rebonabis ..	Rebotalho ..	Rebraco.....	Rebrousser ..
3	Rebeldom ..	Rebengabel ..	Rebhuehner ..	Reblaus.....	Reboatorum ..	Rebondonne ..	Rebotamos ..	Rebramaba ..	Rebruler
3 1/2	Rebelim	Rebengott ..	Rebhuhn	Reblechon ..	Reboavimus ..	Rebonneter ..	Rebotaria... ..	Rebramos... ..	Rebsieb
4	Rebellabar ..	Rebengruen ..	Rebicado	Reblessais ..	Rebocado	Reboquear ..	Rebotines ..	Rebramando ..	Rebstock....
5	Rebellamus ..	Rebenholz ..	Rebiffer.....	Reblessor ..	Rebocadura ..	Rebora	Rebotage	Rebramar... ..	Rebstueck... ..
6	Rebellar	Rebenlaub ..	Rebimba.....	Reblessiez ..	Rebocar	Rebordagem ..	Rebouchage ..	Rebramaron ..	Rebucous ...

GALVANIZED. EXTRA LONG.

Size Pipe, Inches.	4 Inches.	5 Inches.	6 Inches.	7 Inches.	8 Inches.	9 Inches.	10 Inches.	11 Inches.	12 Inches.
1/8	Rebudiaba..	Rebuffade...	Rebullimos ..	Reburujeis ..	Rebutement ..	Recaigamos ..	Recaleis.....	Recalvorum ..	Recand esco
1/4	Rebudiando ..	Rebuffing... ..	Rebullir	Reburujo ...	Rebutir	Recaimos... ..	Recaleniar ..	Recalvos	Recantabis..
3/8	Rebudiard ..	Rebufos	Rebulliran ..	Reburying ..	Rebutal.....	Recaisteis... ..	Recalente ..	Recalvum... ..	Recantarem ..
1/2	Rebudiaron ..	Rebuild	Rebullint... ..	Rebus	Recabada ...	Recalades ..	Recalceses ..	Recalzaras ..	Recantavit ..
3/4	Rebuenas... ..	Rebufabas... ..	Rebutadas ..	Rebuscadas ..	Recabarar... ..	Recalaron ..	Recalfater ..	Recalzaste ..	Recanted... ..
1	Rebueno	Rebufador ..	Rebutado	Rebusamos... ..	Recabarian ..	Recalcabas ..	Recaliento... ..	Recalzes	Recantones ..
1 1/4	Rebufabais ..	Rebufaj.....	Reburria	Rebuscar... ..	Recabedar... ..	Recalcar	Recall	Recalzones ..	Recapacito ..
1 1/2	Rebufafas ..	Rebufaron ..	Reburrium... ..	Rebuscaron ..	Recabedo... ..	Recalcaria ..	Recallable ..	Recamado... ..	Recapitule ..
2	Rebufafamos ..	Rebukable... ..	Reburrorum ..	Rebusco	Recacheter ..	Recalciner ..	Recalling ..	Recamara... ..	Recaptor
2 1/2	Rebufafarian ..	Rebuketul ..	Reburros... ..	Rebusque... ..	Recadar.....	Recalcitro... ..	Recallment... ..	Recambiar... ..	Recaptura... ..
3	Rebufafaron ..	Rebuking	Reburujado ..	Rebutamos... ..	Recadista ...	Recalculer ..	Recalmon... ..	Recambiar... ..	Recardant... ..
4	Rebuff	Rebullida... ..	Reburujar... ..	Rebutassas ..	Recado	Recalbat... ..	Recalcoir ..	Recambio... ..	Recarga.....

†Carried in San Francisco only.

In Orders and Specifications give Plate Numbers and Sizes.

†RAILING FITTINGS.

GLOBE PATTERN. FOR FENCES, ENCLOSING ENGINES AND MACHINERY, EXHIBITION SPACES, ETC



†2409-C.
Elbow.
A

†2410-C.
Side Outlet Elbow.
B

†2411-C.
Tee.
C

†2412-C.
Side Outlet Tee.
D

BLACK RAILING ELBOWS-A—2409-C.

Code.....	Recargaron	Recargasen	Recarnify	Recarried	Recarrying	Recasts
Size, inches.....	½	¾	1	1¼	1½	2
Each	\$0.15	.20	.25	.35	.45	.75
Weight per 100, lbs.....	28	43½	81	100	150	220

BLACK RAILING ELBOWS, SIDE OUTLET-B—2410-C.

Code.....	Recasuram	Recasuors	Recataban	Recatada	Recatonazo	Recatonia
Size, inches.....	½	¾	1	1¼	1½	2
Each	\$0.20	.25	.30	.40	.50	.80
Weight per 100, lbs.....	30	47	82	110	150	210

BLACK RAILING TEES-C—2411-C.

Code.....	Recaudando	Recaundanza	Recaudas	Recausais	Recavaste	Recavebunt
Size, inches.....	½	¾	1	1¼	1½	2
Each	\$0.20	.25	.30	.40	.50	.80
Weight per 100, lbs.....	30	47	81	100	150	210

BLACK RAILING TEES, WITH ONE LEFT-HAND THREAD—CC.

Code.....	Recavem	Recavarant	Recent
Size, inches.....	1	1¼	1½
Each.....	\$0.35	.45	.60
Weight per 100, lbs.....	81	100	150

BLACK RAILING TEES, SIDE OUTLET-D—2412-C.

Code.....	Recentabar	Recentada	Recental	Recentando	Recentaras	Recentaval
Size, inches.....	½	¾	1	1¼	1½	2
Each	\$0.30	.35	.40	.50	.60	1.00
Weight per 100, lbs.....	30	47	90	110	140	210

BLACK RAILING TEES, SIDE OUTLET—DD.

With One Left Hand Thread.

Code.....	Recentem	Recentibus	Recentium
Size, inches.....	1	1¼	1½
Each.....	\$0.45	.60	.70
Weight per 100, lbs.....	90	110	140

PLEASE READ THIS NOTE WITH CARE.

To construct a railing two pipes high, the upper outlet of all fittings used in lower pipes should be tapped with left-hand thread, but when orders are sent us without specifying how outlets are to be tapped, all fittings will invariably be furnished right-hand.

As the fittings do not need to be steam or water-tight, a sufficiently clean thread to screw up well and make a good job, can be made by running a left-hand tap into any outlet tapped right-hand.

†Carried in San Francisco only.

In Orders and Specifications give Size and Letter.

† **RAILING FITTINGS.**

GLOBE PATTERN



†2416-C.
Cross.
E



†2417-C.
Side Outlet Cross.
F

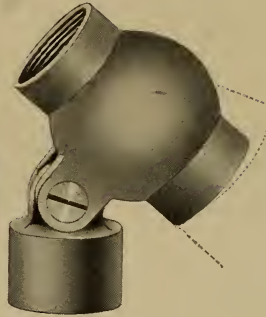

†2418-C.
Stair Hand Rail Tee.
G



†2419-C.
Hinge.
H

BLACK RAILING CROSSES-E—2416-C.

Code	Recently	Recentring	Recepage	Receper	Recepisse	Receptacle
Size, inches.....	½	¾	1	1¼	1½	2
Each	\$0.30	.35	.40	.50	.60	1.00
Weight per 100, lbs.....	30	47	90	100	140	220

BLACK RAILING CROSSES, SIDE OUTLET-F—2417-C.

Code	Receptador	Receptary	Receptasen	Recepteurs	Receptice	Reception
Size, inches.....	½	¾	1	1¼	1½	2
Each	\$0.35	.40	.45	.55	.75	1.35
Weight per 100, lbs.....	30	48½	90½	120	160	192

BLACK STAIR HAND RAIL TEES-G—2418-C.

Adjustable.

Code	Receptoras	Receptrix	Recessed
Size, inches.....	¾	1	1¼
Each	\$0.90	1.30	2.00
Weight per 100, lbs.....	60	90	160

BLACK HINGES FOR PIPE GATE-H—2419-C.

Code.....	Recessorum	Recessos	Recetadora	Recetero
Size, inches.....	½	¾	1	1¼
Each.....	\$0.70	.80	.90	1.10
Weight per 100, lbs.....	30	40	60	90

All Railing Fittings will be shipped with Right Hand Threads unless otherwise ordered.

†Carried in San Francisco only.

In Orders and Specifications give Size and Letter.

† **RAILING FITTINGS.**

GLOBE PATTERN.



† **2422-C.**
Double Foot Rail Bracket.
I



† **2423-C.**
Single Foot Rail Bracket.
J

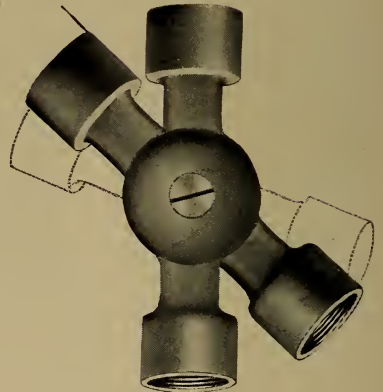

† **2424-C.**
Stair Hand Rail Cross.
K

BLACK DOUBLE FOOT RAIL BRACKETS-I—2422-C.

Grey Iron. 8½ inches length over all.

Code.....	Recetoria	Recettes	Recevait	Receveur
Size, inches.....	½	¾	1	1¼
Each.....	\$0.40	.50	.70	.80
Weight per 100, lbs.....	112	180	190	230

BLACK SINGLE FOOT RAIL BRACKETS-J—2423-C.

Grey Iron. 7¼ inches length over all.

Code.....	Recevoir	Receveziz	Rechabita	Rechacar
Size, inches.....	½	¾	1	1¼
Each.....	\$0.40	.40	.50	.60
Weight per 100, lbs.....	88	125	137½	188

BLACK STAIR HAND RAIL CROSSES-K—2424-C.

Adjustable.

Code.....	Rechaco	Rechamos	Rechampir
Size, inches.....	¾	1	1¼
Each.....	\$1.30	1.60	2.40
Weight per 100, lbs.....	115	200	300

All Railing Fittings will be shipped with Right Hand Threads unless otherwise ordered. As these fittings do not need to be steam or water tight, a sufficiently clean thread to screw up well and make a good job can be made by running a left-hand tap into any outlet tapped right-hand.

† Carried in San Francisco only.

In Orders and Specifications give Sizes and Letters.

RAILING FITTINGS.

GLOBE PATTERN.

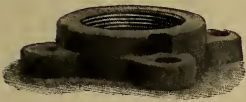

2427-C.
Square Flange—L.



2428-C.
Acorn—M.



2429-C.
End for Foot Rail—N.



2430-C.
Round Flange—S.

† **BLACK RAILING FLANGES, SQUARE-L—2427-C.**

Code.....	Rechamum	Rechange	Recharger	Rechasing	Rechassais	Rechassant	Rechassiez	Rechassons
Size, inches.....	¼	⅜	½	¾	1	1¼	1½	2
Each	\$0.10	.10	.10	.12	.18	.24	.30	.42
Weight per 100, lbs.....	18	18	25	31½	46½	109	130	165

† **BLACK RAILING ACORNS-M—2428-C.**

Code.....	Rechatas	Rechauffes	Rechasse	Rechazaban	Recharazen	Rechazo
Size, inches.....	½	¾	1	1¼	1½	2
Each	\$0.16	.18	.20	.25	.35	.90
Weight per 100, lbs.....	30	40	50	70	90	160

† **BRASS ENDS FOR FOOT RAIL-N—2429-C.**

Code.....	Reheadura	Rehear	Rechenbar	Rechenbuch	Rechenheft
Size, inches.....	½	¾	1	1¼	1½
Each	\$0.60	.70	.80	1.00	1.20
Weight per 100, lbs.....	9½	17¼	28

BLACK ROUND RAILING FLANGES-S—2430-C.

Code.....	Rechenmahl	Rechenstab	Recherches	Rechiflado	Rechiflar	Rechiffeis	Rechiflo	Rechignard
Size, inches.....	¼	⅜	½	¾	1	1¼	1½	2
Diameter of Flange, inches.....	2½	2¾	2⅞	3¼	3⅝	4⅞	4½	5
Each	\$0.14	.14	.15	.18	.22	.25	.36	.45
Weight per 100, lbs.....	30½	48	60	90	130	164½	208

† **GALVANIZED ROUND RAILING FLANGES-S—2430-C.**

Code.....	Rechigne	Rechigneux	Rechinabas	Rechinador	Rechinamos	Rechinante	Rechineis
Size, inches.....	¾	½	¾	1	1¼	1½	2
Diameter of Flange, inches.....	2⅞	2⅞	3¼	3⅝	4⅞	4½	5
Each	\$0.28	.30	.36	.44	.50	.72	.90
Weight per 100, lbs.....

† Carried in San Francisco only.

In Orders and Specifications give Sizes and Letters.

† **BRASS STEAM FITTINGS.**

IRON PIPE SIZES.



†2433-C.
Elbow.

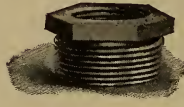

†2434-C.
Bushing.

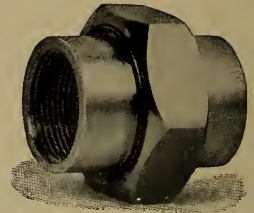

†2435-C.
Union.

ROUGH.

Size, inches..	1/8	1/4	3/8	1/2	3/4	1	1 1/4	1 1/2	2
Code.....	Rechino	Rechnung	Rechnungen	Rechodes	Rechonchas	Rechoncho	Rechoose	Rechoosing	Recht
Elbows	\$0.12	.17	.21	.28	.35	.50	.85	1.10	1.50
Code.....	Rechttraad	Rechteck	Rechteckig	Rechten	Rechterarm	Rechteroog	Rechterzak	Rechthaber	Rechtbol
45° Elbows ..	\$.....	.25	.30	.40	.50	.75	1.25	1.65	2.25
Code.....	Rechthoek	Rechtkamer	Rechtlich	Rechtlinig	Rechtmaken	Rechtsab	Rechtsache	Rechtsban	Rechtsbuch
Tees	\$0.15	.20	.30	.40	.50	.75	1.00	1.30	1.75
Code.....	Rechtsch	Rechtsfall	Rechtsform	Rechtsgang	Rechtsher	Rechtsjahr	Rechtslaan	Rechtsweg	Rechtuit
Crosses	\$0.20	.30	.40	.50	.60	.80	1.50	2.00	3.50
Code.....	Rechtszaak	Rechupete	Rechutes	Recibiais	Recibidero	Recibidora	Recibidou	Recibieron	Recibimos
Caps	\$0.15	.15	.20	.25	.35	.45	.60	.80	1.10
Code.....	Recibos	Recidebat	Reciditore	Reciditura	Recidivare	Recidive	Recidivous	Recidono	Recidunt
Plugs	\$0.09	.10	.12	.15	.20	.28	.40	.50	.90
Code.....	Recientes	Recifoso	Recimenter	Recinchado	Recinchar	Recincheis	Recincho	Recinctum	Recinebam
Lock-Nuts ...	\$0.10	.10	.12	.15	.20	.30	.45	.70	.95
Code.....	Recineron	Recineses	Recingebat	Recingeret	Recingimus	Reciniato	Reciniatus	Recinican	
Bushings, to reduce one size \$.....		.10	.12	.14	.21	.38	.50	.67	1.00
Code.....	Recipero	Recipiamus	Recipiancy	Recipiebat	Recipients	Recipitore	Recipiunt	Recipiam	
Reducers	\$.....	.16	.22	.32	.45	.65	.90	1.12	1.85
Code.....	Reciprocar	Reciproque	Recisarum	Recisionem	Recitaculo	Recitandos	Recitasen	Recitatisis	Recitavero
Couplings	\$0.10	.14	.16	.25	.37	.50	.60	.90	1.35
Code.....	Recitavit	Reciteriez	Reciting	Recitons	Recizalla	Reckenhaft			
Return Bends ..	\$.....			.60	.80	1.15	1.75	2.50	3.50

FINISHED.

Size, inches..	1/8	1/4	3/8	1/2	3/4	1	1 1/4	1 1/2	2
Code.....	Reckholder	Reckless	Reckling	Reckon	Reckoning	Reckzeng	Reclaim	Reclamabas	Reclamante
Elbows	\$0.24	.34	.42	.56	.70	1.00	1.70	2.20	3.00
Code.....	Redamaran	Reclamarlo	Reclamarlo	Reclamasse	Reclamero	Reclames	Reclameurs	Reclamiez	Reclamollo
45° Elbows ..	\$.....	.42	.50	.68	.85	1.25	2.10	2.75	3.75
Code.....	Reclamper	Reclanges	Reclangunt	Reclinado	Reclinar	Reclinatif	Reclinavit	Reclineis	Reclinorum
Tees	\$0.30	.40	.60	.80	1.00	1.50	2.00	2.60	3.50
Code.....	Reclivarum	Reclouait	Reclouyames	Recloueras	Recludebat	Recludimus	Recludo	Recludunt	Recluiamos
Crosses	\$0.40	.60	.80	1.00	1.20	1.60	3.00	4.00	7.00
Code.....	Recluiria	Reclusabor	Reclusamur	Reclusanda	Reclusatos	Recluse	Recluseris	Reclusuram	Recluta
Caps	\$0.30	.30	.40	.50	.70	.90	1.20	1.60	2.20
Code.....	Reclutammo	Reclutando	Reclutaron	Reclutassi	Reclutato	Reclutava	Recluyam	Recoasting	Recobradas
Plugs	\$0.18	.20	.24	.30	.40	.56	.80	1.00	1.80
Code.....	Recobramos	Recobrar	Recobro	Recoctions	Recocto	Recodabais	Recodadas	Recodarian	
Lock-Nuts ...	\$.....	.20	.24	.30	.40	.60	.90	1.40	1.90
Code.....	Recodas	Recogedera	Recogendos	Recogia	Recogites	Recognise	Recognitif	Recognitium	Recognized
Nipples, Close	\$0.12	.15	.20	.25	.30	.40	.60	.90	1.25
Code.....	Recognosco	Recoil	Recoinage	Recojamos	Recolabo	Recolados	Recolarias	Recolaste	
Bushings, to reduce one size \$.....		.20	.24	.28	.42	.76	1.00	1.35	2.00
Code.....	Recolectar	Recolecto	Recolhedor	Recolheito	Recolther	Recolhida	Recollect	Recolliger	
Reducers	\$.....	.32	.44	.64	.90	1.30	1.80	2.25	3.70
Code.....	Recollions	Recolrait	Recoltable	Recoltames	Recoltant	Recolteras	Recoltiez	Recombine	Recomblant
Unions, Ground									
Joint.....	\$0.32	.36	.50	.70	.90	1.25	1.70	2.50	3.60
Code.....	Recomende	Recomer	Recomienda	Recommence	Recommit	Recommoneo	Recompact	Recompsa	Recompile
Couplings ..	\$0.20	.28	.32	.50	.75	1.00	1.20	1.80	2.70
Code.....	Recomplete	Recompor	Recomposed	Recomptage	Recomptait	Reconcavo			
Return Bends ..	\$.....			1.20	1.60	2.30	3.50	5.00	7.00

†Carried in San Francisco only.

In Orders and Specifications give Names and Sizes.

† **CAST IRON ELBOWS.**

STANDARD.



2440-C.
Elbow.



2441-C.
Reducing Elbow.



2442-C.
45° Elbow.

STRAIGHT SIZES—2440-C.

Code.....	Reconcludo	Recondes	Recondidis	Reconduct	Reconduxit	Reconduzir	Reconfesse	Reconfirm	Reconjoin
Size, inches.....	1/2	3/4	1	1 1/4	1 1/2	2	2 1/2	3	3 1/2
Each.....	\$0.06	.08	.10 1/2	.16	.20	.28	.50	.75	1.05
Weight each, lbs....	.30	.55	.80	1.19	1.87	2.62	5	6.43	10

Code.....	Reconning	Reconozcas	Reconquers	Reconquest	Reconsider	Reconsigno	Reconslute	Recontando
Size, inches.....	4	4 1/2	5	6	7	8	10	12
Each.....	\$1.20	1.75	2.00	2.75	4.70	6.75	13.50	20.00
Weight each, lbs....	14.42	15.25	22.73	31.75	46.5	58	103.5	160

RIGHT AND LEFT HAND—2440-C.

Code.....	Reconvir	Reconvoyer	Recopilado	Recopilar	Recoquamus	Recoquebat
Size, inches.....	1/2	3/4	1	1 1/4	1 1/2	2
Each.....	\$0.07	.09	.12	.18	.23	.32
Weight each, lbs.....	.3	.55	.8	1.18	1.87	2.62

REDUCING SIZES—2441-C.

Code.....	Recontar	Recontemos	Recontento	Recontinue	Recontans	Reconvenir	Reconverts	Reconveyed	Reconvido
Size, inches.....	3/4 x 1/2	1 x 3/4	1 x 1/2	1 1/4 x 1	1 1/4 x 3/4	1 1/4 x 1/2	1 1/2 x 1 1/4	1 1/2 x 1	1 1/2 x 3/4
Each.....	\$0.09	.12	.12	.18	.18	.18	.23	.23	.23
Weight each, lbs....	.5	.77	1.12	1.37	1	1	1.75	1.5	1.43

Code.....	Recoquille	Recoquin	Recordabas	Recordacao	Recordador	Recordamur	Recordance	Recordar	Recordatos
Size, inches.....	2 x 1 1/2	2 x 1 1/4	2 x 1	2 1/2 x 2	2 1/2 x 1 1/2	3 x 2 1/2	3 x 2	4 x 3	4 x 2 1/2
Each.....	\$0.32	.32	.32	.60	.60	.85	.85	1.40	1.40
Weight each, lbs....	2.37	1.75	1.75	3.25	5.19	6.5	5.5	10.5	18

Code.....	Recorporo	Recorrente	Recorridos	Recortadas	Recortaria	Recortase
Size, inches.....	4 x 2	5 x 4	5 x 3	6 x 5	6 x 4	8 x 6
Each.....	\$1.40	2.30	2.30	3.15	3.15	7.75
Weight each, lbs.....	9.12	19.5	28	34.25	37.5	67

45° SIZES—2442-C.

Code.....	Recorte	Recorvada	Recorvan	Recorvaras	Recosidas	Recostarar	Recostaste	Recottoner
Size, inches.....	1/2	3/4	1	1 1/4	1 1/2	2	2 1/2	3
Each.....	\$0.07	.10	.12	.19	.24	.34	.60	.90
Weight each, lbs.....	.34	.51	.94	1.31	1.62	2.12	3.75	5.75

Code.....	Recouché	Recouleuse	Recoupait	Recouperas	Recouptions	Recoupplant	Recoupment
Size, inches.....	3 1/2	4	4 1/2	5	6	7	8
Each.....	\$1.25	1.45	2.20	2.50	3.45	5.90	8.50
Weight each, lbs.....	8.8	12.75	17	15.5	25.25	32	42

†Carried in San Francisco only.

In Orders and Specifications give Plate Numbers and Sizes.

† **CAST IRON TEES.**

STANDARD



2445-C.

Tee.



2446-C.

Reducing Tee.



2447-C.

Reducing Tee.

In describing Tees, the Rim is first named, then the Outlet, thus:

$$\frac{1}{2}T\frac{3}{8} = \frac{1}{2} \times \frac{3}{8} \times \frac{3}{4}.$$

STRAIGHT SIZES—2445-C.

Code.....	Recoupmers	Recoupmesk	Recoupmeth	Recoupmevi	Recoupmew	Recoupnaba
Size, inches.....	½	¾	1	1¼	1½	2
Each.....	\$0.09	.12	.15	.23	.29	.41
Weight each, lbs.....	.4	.7	1.1	1.5	2.6	3.3
Code.....	Recounpaco	Recounpadu	Recounpafi	Recounpag	Recounpaka	Recounpame
Size, inches.....	2½	3	3½	4	4½	5
Each.....	\$0.73	1.10	1.50	1.75	2.55	3.00
Weight each, lbs.....	6	12	13.2	19.7	22.1	35
Code.....	Recoupneat	Recoupnebs	Recoupneck	Recoupnot	Recoupos	
Size, inches.....	6	7	8	10	12	
Each.....	\$4.00	6.80	9.75	19.50	29.00	
Weight each, lbs.....	38.7	54	62.6	131.5	200	

REDUCING SIZES.

Code.	Size Pipe, Inches.	Weight Each, Lbs.	Each.	Code.	Size Pipe Inches.	Weight Each, Lbs.	Each.
Recourbait.....	½ x ½ x ¾	.7	\$0.10	Recresco.....	1 x1 x1¼	2.5	\$0.17
Recourbons.....	½ x ½ x1	.8	.10	Recriaba.....	1 x1 x1½	1.5	.17
Recourbure.....	¾ x ½ x ½	.8	.14	Recriadora.....	1 x1 x2	3.1	.17
Recourumes.....	¾ x ½ x ¾	.8	.14	Recriamos.....	1¼ x ½ x1¼	1.7	.27
Recouvrage.....	¾ x ½ x1	1.3	.14	Recriaron.....	1¼ x ½ x1½	2.2	.27
Recouvrais.....	¾ x ¾ x ½	.8	.14	Recribler.....	1¼ x ¾ x ¾	1.7	.27
Recova.....	¾ x ¾ x1	1.3	.14	Recriminar.....	1¼ x ¾ x1	2.	.27
Recovagem.....	¾ x ¾ x1¼	1.2	.14	Recrimino.....	1¼ x ¾ x1¼	1.7	.27
Recovered.....	¾ x ¾ x1½	1.8	.14	Recrossed.....	1¼ x ¾ x1½	2.2	.27
Recoveror.....	¾ x ¾ x2	3.6	.14	Recrotter.....	1¼ x ¾ x2	3.	.27
Recocer.....	1 x ½ x ½	1.1	.17	Recruit.....	1¼ x1 x ½	1.5	.27
Recran.....	1 x ½ x ¾	1.	.17	Recrujido.....	1¼ x1 x ¾	1.2	.27
Recreabas.....	1 x ½ x1	1.5	.17	Recrujiera.....	1¼ x1 x1	1.5	.27
Recreator.....	1 x ¾ x ½	1.	.17	Recrujimos.....	1¼ x1 x1¼	1.5	.27
Recreancy.....	1 x ¾ x ¾	1.6	.17	Recrutador.....	1¼ x1 x1½	2.2	.27
Recrearen.....	1 x ¾ x1	1.2	.17	Recrutar.....	1¼ x1 x2	3.	.27
Recreated.....	1 x ¾ x1¼	1.5	.17	Recruteras.....	1¼ x1¼ x ½	1.2	.27
Recremabo.....	1 x ¾ x1½	1.5	.17	Recruteurs.....	1¼ x1¼ x ¾	1.5	.27
Recrepabas.....	1 x ¾ x2	3.7	.17	Recrutons.....	1¼ x1¼ x1	1.5	.27
Recrepem.....	1 x1 x ½	1.	.17	Recrutume.....	1¼ x1¼ x1½	3.	.27
Recrescer.....	1 x1 x ¾	1.1	.17	Rectagona.....	1¼ x1¼ x2	3.	.27

† Carried in San Francisco only.

In Orders and Specifications give Plate Numbers and Sizes.

†CAST IRON REDUCING TEES—Continued.

Code.	Size Pipe, Inches.	Weight Each, Lbs.	Each.	Code.	Size Pipe, Inches.	Weight Each, Lbs.	Each.
Rectamente.....	1½ x ½ x 1¼	1.7	\$0.33	Recursabo.....	2½ x 2 x 2	4.6	\$0.83
Rectangle.....	1½ x ½ x 1½	2.2	.33	Recursites.....	2½ x 2 x 2½	7.5	.83
Recteur.....	1½ x ¾ x ¾	3.	.33	Recursito.....	2½ x 2 x 3	8.	.83
Recticorne.....	1½ x ¾ x 1	3.	.33	Recursos.....	2½ x 2½ x ½	3.5	.83
Rectidao.....	1½ x ¾ x 1¼	3.3	.33	Recurvabor.....	2½ x 2½ x ¾	5.1	.83
Rectificar.....	1½ x ¾ x 1½	3.3	.33	Recurvamur.....	2½ x 2½ x 1	4.2	.83
Rectifio.....	1½ x ¾ x 2	3.7	.33	Recurvandi.....	2½ x 2½ x 1¼	5.	.83
Rectifier.....	1½ x 1 x ½	1.8	.33	Recurve.....	2½ x 2½ x 1½	4.7	.83
Rectifions.....	1½ x 1 x ¾	2.	.33	Recurvity.....	2½ x 2½ x 2	6.7	.83
Rectiflore.....	1½ x 1 x 1	1.2	.33	Recurvor.....	2½ x 2½ x 3	8.5	.83
Rectifying.....	1½ x 1 x 1¼	2.	.33	Recurvous.....	2½ x 2½ x 4	17.	
Rectifgrade.....	1½ x 1 x 1½	2.2	.33	Recusable.....	3 x 1 x 3	7.2	1.25
Rectiligne.....	1½ x 1 x 2	2.8	.33	Recusadora.....	3 x 1¼ x 3	7.5	1.25
Rectilino.....	1½ x 1¼ x ½	1.2	.33	Recusamur.....	3 x 1½ x 2	10.	1.25
Rectinerne.....	1½ x 1¼ x ¾	2.1	.33	Recusancy.....	3 x 1½ x 2½	11.	1.25
Rectitude.....	1½ x 1¼ x 1	1.8	.33	Recusative.....	3 x 1½ x 3	10.	1.25
Recto.....	1½ x 1¼ x 1¼	1.7	.33	Recusavel.....	3 x 2 x 1	8.2	1.25
Rectorado.....	1½ x 1¼ x 1½	2.3	.33	Recuser.....	3 x 2 x 1¼	8.2	1.25
Rectoress.....	1½ x 1¼ x 2	2.7	.33	Recussion.....	3 x 2 x 1½	8.2	1.25
Rectors.....	1½ x 1½ x ½	1.5	.33	Recussus.....	3 x 2 x 2	6.	1.25
Rectorship.....	1½ x 1½ x ¾	2.	.33	Recutio.....	3 x 2 x 2½	8.5	1.25
Rectotomie.....	1½ x 1½ x 1	2.2	.33	Recutionem.....	3 x 2½ x 1	5.7	1.25
Rectrix.....	1½ x 1¼ x 1¼	1.7	.33	Recutionis.....	3 x 2½ x 1¼	7.5	1.25
Recuada.....	1½ x 1½ x 2	3.7	.33	Recutitos.....	3 x 2½ x 1½	5.2	1.25
Recuadeira.....	2 x ½ x 2	2.7	.47	Recutitum.....	3 x 2½ x 2	9.5	1.25
Recuadrar.....	2 x ¾ x 1½	3.2	.47	Redaccendo.....	3 x 2½ x 2½	7.5	1.25
Recuaje.....	2 x ¾ x 2	3.	.47	Redactadas.....	3 x 2½ x 3	8.2	1.25
Recuarta.....	2 x 1 x ¾	3.8	.47	Redactado.....	3 x 3 x ¾	6.5	1.25
Recubamus.....	2 x 1 x 1	3.7	.47	Redactamos.....	3 x 3 x 1	6.	1.25
Recudis.....	2 x 1 x 1¼	2.7	.47	Redactaron.....	3 x 3 x 1¼	8.	1.25
Recueces.....	2 x 1 x 1½	3.7	.47	Redacteurs.....	3 x 3 x 1½	8.	1.25
Recuentos.....	2 x 1 x 2	3.6	.47	Redaction.....	3 x 3 x 2	9.7	1.25
Recuerdos.....	2 x 1¼ x ¾	2.7	.47	Redacto.....	3 x 3 x 2½	8.5	1.25
Recuestan.....	2 x 1¼ x 1	2.5	.47	Redactora.....	3 x 3 x 3½	17.	1.25
Recuidar.....	2 x 1¼ x 1¼	3.7	.47	Redactores.....	3 x 3 x 4	12.	1.25
Recuisage.....	2 x 1¼ x 1½	3.	.47	Redada.....	3½ x 1 x 3½	10.7	1.75
Recuisimes.....	2 x 1¼ x 2	4.1	.47	Redadopto.....	3½ x 1¼ x 3½	10.7	1.75
Recuisson.....	2 x 1½ x ½	2.8	.47	Redadores.....	3½ x 1½ x 3½	11.	1.75
Recuit.....	2 x 1½ x ¾	2.7	.47	Redamapar.....	3½ x 2 x 3½	11.2	1.75
Reculaban.....	2 x 1½ x 1	3.	.47	Redamabunt.....	3½ x 2½ x 2	11.7	1.75
Reculames.....	2 x 1½ x 1¼	2.6	.47	Redamandos.....	3½ x 2½ x 2½	13.5	1.75
Reculasses.....	2 x 1½ x 1½	3.	.47	Redamaret.....	3½ x 2½ x 3	10.5	1.75
Reculbium.....	2 x 1½ x 2	4.5	.47	Redamatos.....	3½ x 3 x 1½	10.7	1.75
Reculerons.....	2 x 1½ x 2½	4.7	.47	Redamatura.....	3½ x 3 x 2	10.7	1.75
Reculeurs.....	2 x 2 x ½	2.2	.47	Redamavero.....	3½ x 3 x 2½	9.	1.75
Reculons.....	2 x 2 x ¾	2.7	.47	Redambules.....	3½ x 3 x 3	10.5	1.75
Recultiver.....	2 x 2 x 1	3.7	.47	Redambulo.....	3½ x 3½ x 1	8.5	1.75
Recultum.....	2 x 2 x 1¼	3.2	.47	Redamento.....	3½ x 3½ x 1¼	8.5	1.75
Reculturi.....	2 x 2 x 1½	3.1	.47	Redanho.....	3½ x 3½ x 1½	9.	1.75
Recumar.....	2 x 2 x 2½	4.5	.47	Redanimabo.....	3½ x 3½ x 2	9.	1.75
Recumbing.....	2 x 2 x 3	10.5	.47	Redanimes.....	3½ x 3½ x 2½	11.5	1.75
Recuperar.....	2½ x ¾ x 2½	7.	.83	Redanser.....	3½ x 3½ x 3	13.	1.75
Recurabas.....	2½ x 1 x 2½	7.	.83	Redardesco.....	3½ x 3½ x 4	13.8	1.75
Recurage.....	2½ x 1¼ x 2	5.	.83	Redargutos.....	4 x 1 x 4	16.5	2.00
Recurando.....	2½ x 1¼ x 2½	5.7	.83	Redarios.....	4 x 1¼ x 4	15.	2.00
Recuraran.....	2½ x 1½ x 1	6.5	.83	Redarium.....	4 x 1½ x 4	11.5	2.00
Recuratura.....	2½ x 1½ x 1¼	6.5	.83	Redarmarem.....	4 x 2 x 1½	19.5	2.00
Recuravit.....	2½ x 1½ x 1½	6.5	.83	Redarmas.....	4 x 2 x 2½	17.7	2.00
Recuremus.....	2½ x 1½ x 2	6.7	.83	Redarmato.....	4 x 2 x 3	16.	2.00
Recurramos.....	2½ x 1½ x 2½	6.8	.83	Redarmem.....	4 x 2 x 4	14.7	2.00
Recurrance.....	2½ x 2 x ½	4.	.83	Redarmemal.....	4 x 2½ x 1	13.5	2.00
Recurrent.....	2½ x 2 x ¾	4.	.83	Redarmemus.....	4 x 2½ x 1½	17.5	2.00
Recurrentis.....	2½ x 2 x 1	3.7	.83	Redauspico.....	4 x 2½ x 2	17.	2.00
Recurridas.....	2½ x 2 x 1¼	3.8	.83	Redbreast.....	4 x 2½ x 2½	17.	2.00
Recurring.....	2½ x 2 x 1½	3.7	.83	Redbud.....	4 x 2½ x 3	17.	2.00

†Carried in San Francisco only.

In Orders and Specifications give Plate Numbers and Sizes.

†CAST IRON REDUCING TEES—Continued.

Code.	Size Pipe, Inches.	Weight Each, Lbs.	Each.	Code.	Size Pipe, Inches.	Weight Each, Lbs.	Each.
Redburga.....	4 x2 1/2 x4	12.5	\$2.00	Redemptory.....	5 x3 x3	22.5	\$3.50
Redcoat.....	4 x3 x 3/4	13.	2.00	Redemptrix.....	5 x3 x4	37.	3.50
Reddebanus.....	4 x3 x1	13.	2.00	Redencion.....	5 x3 x5	23.	3.50
Reddendos.....	4 x3 x1 1/4	13.	2.00	Redensart.....	5 x4 x2	15.	3.50
Reddendum.....	4 x3 x1 1/2	15.	2.00	Redentora.....	5 x4 x2 1/2	18.7	3.50
Reddening.....	4 x3 x2	17.	2.00	Redentores.....	5 x4 x3	19.5	3.50
Redderen.....	4 x3 x2 1/2	12.2	2.00	Redentrice.....	5 x4 x4	32.	3.50
Reddidero.....	4 x3 x3	15.8	2.00	Redeposit.....	5 x4 x5	22.	3.50
Redeblume.....	4 x3 x3 1/2	19.	2.00	Redeprunk.....	5 x5 x1 1/4	22.5	3.50
Redebute.....	4 x3 x4	16.	2.00	Rederanger.....	5 x5 x1 1/2	20.5	3.50
Redecilla.....	4 x3 1/2 x2 1/2	16.	2.00	Rederang.....	5 x5 x2	18.2	3.50
Redecorons.....	4 x3 1/2 x3	14.	2.00	Redergues.....	5 x5 x2 1/2	25.	3.50
Rededicate.....	4 x3 1/2 x3 1/2	13.8	2.00	Rederguo.....	5 x5 x3	27.5	3.50
Redeemless.....	4 x3 1/2 x4	13.8	2.00	Rederos.....	5 x5 x3 1/2	30.	3.50
Redefait.....	4 x4 x 3/4	11.	2.00	Redesatz.....	5 x5 x4	33.	3.50
Redefertig.....	4 x4 x1	10.	2.00	Redesire.....	6 x3 x6	33.	4.60
Redefiant.....	4 x4 x1 1/4	10.	2.00	Redespiel.....	6 x4 x6	38.	4.60
Redefigur.....	4 x4 x1 1/2	10.5	2.00	Redestrom.....	6 x5 x6	41.	4.60
Redefiler.....	4 x4 x2	13.5	2.00	Redesturm.....	6 x6 x2	25.5	4.60
Redefluss.....	4 x4 x2 1/2	15.	2.00	Redeton.....	6 x6 x2 1/2	25.5	4.60
Redefolle.....	4 x4 x3	13.7	2.00	Redetwist.....	6 x6 x3	32.5	4.60
Redeform.....	4 x4 x3 1/2	16.5	2.00	Redeuntis.....	6 x6 x4	38.	4.60
Redekundig.....	4 x4 x5	23.5	2.00	Redevance.....	6 x6 x5	41.7	4.60
Redekunst.....	4 x4 x6	33.	2.00	Redevenir.....	7 x6 x7	7.80
Redelehre.....	4 1/2 x4 1/2 x2	14.	2.95	Redflower.....	7 x7 x6	7.80
Redelicht.....	4 1/2 x4 1/2 x2 1/2	16.5	2.95	Redhalabo.....	8 x6 x6	80.	11.25
Redelivery.....	4 1/2 x4 1/2 x3	11.7	2.95	Redhales.....	8 x6 x8	72.	11.25
Redelust.....	4 1/2 x4 1/2 x3 1/2	23.	2.95	Redhibeas.....	8 x8 x4	56.	11.25
Redelustig.....	4 1/2 x4 1/2 x4	13.	2.95	Redhibido.....	8 x8 x5	65.	11.25
Redemand.....	5 x2 x5	21.5	3.50	Redhibir.....	8 x8 x6	73.	11.25
Redemander.....	5 x2 1/2 x3	22.5	3.50	Redhibo.....	9 x9 x5	15.00
Redemising.....	5 x2 1/2 x4	37.	3.50	Redhostio.....	10 x8 x8	22.50
Redemisse.....	5 x2 1/2 x5	21.5	3.50	Redicebat.....	10 x10 x8	22.50
Redemptas.....	5 x3 x2	20.	3.50	Redichas.....	12 x 8 x10	33.50
Redempteur.....	5 x3 x2 1/2	20.	3.50	Redicho.....	12 x12 x10	33.50

Other sizes can be furnished on short notice.

†Carried in San Francisco only.

In Orders and Specifications give Plate Numbers and Sizes.

† **CAST IRON CROSSES.**

STANDARD.



2450-C.
Straight.



2451-C.
Reducing.

STRAIGHT SIZES—2450-C.

Code.....	Redichomat	Redichomus	Redichonal	Redichonam	Redichonek	Redichopam
Size, inches.....	½	¾	1	1¼	1½	2
Each.....	\$0.16	.22	.27	.42	.53	.75
Weight each, lbs.....	.54	.87	1.36	2	2.72	4.72
Code.....	Redichorut	Redichose	Redichotu	Redichook	Redichow	Redichpar
Size, inches.....	2½	3	3½	4	4½	5
Each.....	\$1.80	2.00	2.70	3.15	4.60	5.50
Weight each, lbs.....	7	13.5	15.5	23	28	35.5
Code.....		Redichpet	Redichpil	Redichpop	Redicket	Redickop
Size, inches.....		6	7	8	10	12
Each.....		\$7.25	12.25	17.50	35.00	52.50
Weight each, lbs.....		48.5	81	103	150	240

REDUCING SIZES—2451-C.

Code.	Size Pipe, Inches.	Weight Each, Lbs.	Each.	Code.	Size Pipe, Inches.	Weight Each, Lbs.	Each.
Redicter.....	¾ x ¾ x ½ x ½	1.	\$.25	Rediscover.....	3 x 3 x 2½ x 2½	11.	\$ 2.20
Redictons.....	1 x1 x ½ x ½	1.5	.30	Rediseuses.....	3½ x 3½ x 2½ x 2½	12.	3.00
Rediculo.....	1 x1 x ¾ x ¾	1.5	.30	Redissolve.....	3½ x 3½ x 3 x 3	17.	3.00
Redieram.....	1¼ x1¼ x ½ x ½	2.	.46	Reditones.....	4 x 4 x 1¼ x 1¼	9.	3.50
Rediezmo.....	1¼ x1¼ x ¾ x ¾	2.	.46	Redituable.....	4 x 4 x 1½ x 1½	9.5	3.50
Redigebar.....	1¼ x1¼ x1 x1	2.2	.46	Redituar.....	4 x 4 x 2 x 2	10.	3.50
Redigeons.....	1½ x1¼ x1 x1	3.3	.60	Redituro.....	4 x 4 x 2½ x 2½	16.	3.50
Redigimar.....	1½ x1½ x ½ x ½	3.	.60	Rediviam.....	4 x 4 x 3 x 3	15.	3.50
Redimidora.....	1½ x1½ x ¾ x ¾	3.2	.60	Redivise.....	4 x 4 x 3½ x 3½	17.	3.50
Redimamos.....	1½ x1½ x1 x1	3.1	.60	Redivision.....	5 x 5 x 2 x 2	23.	6.00
Redimessi.....	1½ x1½ x1¼ x1¼	3.	.60	Redizimar.....	5 x 5 x 2½ x 2½	24.	6.00
Redimevate.....	2 x2 x ¾ x ¾	4.5	.83	Redlich.....	5 x 5 x 3 x 3	25.	6.00
Redimiamo.....	2 x2 x1 x1	4.5	.83	Redlicher.....	5 x 5 x 4 x 4	33.	6.00
Redimiate.....	2 x2 x1¼ x1¼	3.2	.83	Redmiddel.....	6 x 6 x 2 x 2	8.00
Redimibile.....	2 x2 x1½ x1½	3.7	.83	Redner.....	6 x 6 x 2½ x 2½	8.00
Redimida.....	2½ x2 x1½ x1½	7.7	1.45	Redoblado.....	6 x 6 x 3 x 3	32.	8.00
Redimidora.....	2½ x2½ x ¾ x ¾	9.	1.45	Redoblante.....	6 x 6 x 3½ x 3½	1.45	8.00
Redimieron.....	2½ x2½ x1 x1	9.5	1.45	Redoblaron.....	6 x 6 x 4 x 4	39.	8.00
Rediminish.....	2½ x2½ x1¼ x1¼	9.7	1.45	Redoblo.....	6 x 6 x 5 x 5	8.00
Redimiran.....	2½ x2½ x1½ x1½	6.5	1.45	Redoblones.....	7 x 7 x 5 x 5	13.50
Redimitura.....	2½ x2½ x2 x2	7.5	1.45	Redobra.....	7 x 7 x 6 x 6	13.50
Redinduti.....	3 x3 x ¾ x ¾	8.	2.20	Redolebit.....	8 x 8 x 6 x 6	87.	19.25
Redingo.....	3 x3 x1 x1	8.2	2.20	Redolemos.....	8 x 8 x 7 x 7	19.25
Redinha.....	3 x3 x1¼ x1¼	8.5	2.20	Redoleras.....	10 x10 x 7 x 7	38.50
Rediront.....	3 x3 x1½ x1½	9.	2.20	Redolerian.....	12 x12 x 8 x 8	58.00
Redisburse.....	3 x3 x2 x2	8.	2.20	Redolores.....	12 x12 x10 x10	58.00

† Carried in San Francisco only.

In Orders and Specifications give Plate Numbers and Sizes.

CAST IRON FITTINGS.



† 2454-C.
Cap.



† 2455-C.
Lock-Nut.



† 2456-C.
Reducer.

CAST IRON CAPS—2454-C.

Code.....	Redoma	Redomas	Redomazos	Redomitos	Redomoinho	Redompter	Redonabunt
Size, inches.....	2	2½	3	3½	4	4½	5
Each.....	\$0.26	.40	.54	.75	.87	1.05	1.20
Weight each, lbs.....	7	8.5
Code.....	Redonamus	Redonandos	Redonatura	Redonavit	Redondance		
Size, inches.....	6	7	8	10	12		
Each.....	\$1.55	2.50	2.85	5.50	7.00		
Weight each, lbs.....	16	16.5	23	35.3	71.3		

CAST IRON LOCK-NUTS—2455-C.

Code.....	Redondeado	Redondear	Redondella	Redondilho	Redondo	Redonnais	Redonnant
Size, inches.....	2	2½	3	3½	4	4½	5
Each.....	\$0.25	.27	.34	.47	.64	.85	.90
Weight each, lbs.....
Code.....	Redonniez	Redonnons	Redopelo	Redoptavit	Redoptemur		
Size, inches.....	6	7	8	10	12		
Each.....	\$1.30	1.70	2.35	3.00	4.00		
Weight each, lbs.....		

CAST IRON REDUCERS—2456-C.

Code.....	Redorais	Redorasses	Redores	Redormimus	Redormir	Redormiunt	Redornabar	Redornart		
Size, inches.....	2x1½	2½x1	2½x1¼	2½x1½	2½x2	3x1	3x1¼	3x1½		
Each.....	\$0.43	.60	.60	.60	.60	.80	.80	.80		
Weight each, lbs.....		
Code.....	Redornatos	Redorons	Redotaton	Redoublais	Redouble	Redouca	Redoutable	Redoutais		
Size, inches.....	3x2	3x2½	3½x1½	3½x2	3½x2½	3½x3	4x1½	4x2		
Each.....	\$0.80	.80	1.00	1.00	1.00	1.00	1.35	1.35		
Weight each, lbs.....	7.5	6.5		
Code.....	Redoutes	Redoutiez	Redoutons	Redraft	Redramos	Redraramos	Redrarian	Redraron		
Size, inches.....	4x2½	4x3	4x3½	4½x4	5x3	5x3½	5x4	5x4½		
Each.....	\$1.35	1.35	1.35	1.85	2.00	2.00	2.00	2.00		
Weight each, lbs.....	7.4	6.4	7.75	13.5	10.7	10.5	10.5		
Code.....	Redrawing	Redressait	Redresse	Redressoir	Redrojo	Redrosaca	Redruger	Redruna	Redscheb	Redseard
Size, inches.....	6x2	6x2½	6x3	6x4	6x5	7x6	8x4	8x6	10x8	12x10
Each.....	\$2.70	2.70	2.70	2.70	2.70	5.35	6.75	6.75	10.00	15.00
Weight each, lbs.....	16	17	19	21	36

† Carried in San Francisco only.

In Orders and Specifications give Plate Numbers and Sizes.

CAST IRON PLUGS AND BUSHINGS.



†2459-C.
Plug.



†2460-C.
Bushing.

CAST IRON PLUGS—2459-C.

Code.....	Redselig	Redshank	Redster	Redstreak
Size, inches.....	7	8	10	12
Each.....	\$1.85	2.75	3.75	5.00
Weight each, lbs.....	11.5	15.5	27	41.5

Note—For smaller sizes see page 599.

CAST IRON BUSHINGS—2460-C.

Code.....	Redtails	Reddubber	Reducendum	Reductabo	Reductavit	Reductif	Reductives	Reduirai
Size, inches.....	3½ x 1	3½ x 1¼	4 x 1	4 x 1½	4½ x 2	4½ x 2½	4½ x 3	4½ x 3½
Each.....	\$0.40	.40	.50	.50	.75	.75	.75	.75
Weight each, lbs.....	3.25	4.62	2.25	3.25	3.25	4.12

Code.....	Reduisais	Reduit	Redujera	Redulceres	Redumes	Reduncorum	Reduncos	Redundabas
Size, inches.....	4½ x 4	5 x 2	5 x 2½	5 x 3	5 x 3½	5 x 4½	6 x 2	6 x 2½
Each.....	\$0.75	.93	.93	.93	.93	.93	1.25	1.25
Weight each, lbs.....	4.75	3.62	3.75	3.62	3.62	5.5	5.5	5.5

Code.....	Redundante	Redundaran	Redundaria	Redundemos	Reduplicar	Reduplique	Reduresco	Redusses
Size, inches.....	6 x 3	6 x 3½	6 x 4	6 x 4½	7 x 2	7 x 2½	7 x 3	7 x 3½
Each.....	\$1.25	1.25	1.25	1.25	1.87	1.87	1.87	1.87
Weight each, lbs.....	6	5.75	10	7.75	7.75	7.25	7	8.25

Code.....	Redussions	Reduviarum	Reduvides	Reduivio	Reduivole	Reduivosos	Redluxeram
Size, inches.....	7 x 4	7 x 4½	7 x 5	7 x 6	8 x 2	8 x 3	8 x 4
Each.....	\$1.87	1.87	1.87	1.87	2.75	2.75	2.75
Weight each, lbs.....	7.87	8.5	7.25	7.75	10	9.78

Code.....	Reduzca	Reduzicao	Reduzivel	Reeders
Size, inches.....	8 x 5	8 x 6	8 x 7	10 x 4
Each.....	\$2.75	2.75	2.75	3.75
Weight each, lbs.....	8	8.5	12

Code.....	Reedifant	Reedifcar	Reedificons	Reeditames	Reediton	Reedling	Reefbanden
Size, inches.....	10 x 5	10 x 6	10 x 7	10 x 8	12 x 6	12 x 8	12 x 10
Each.....	\$3.75	3.75	3.75	3.75	5.00	5.00	5.00
Weight each, lbs.....	16.5	17

Note—Other sizes listed on page P 598.

†Carried in San Francisco only.

In Orders and Specifications give Plate Numbers and Sizes.

CAST IRON FLANGE UNIONS.



†2463-C.

BLACK FLANGE UNIONS.

Faced. No Gasket.

Code.....	Reegeit	Reekslen	Reelaiah	Reencher	Reengagies
Size, inches.....	1/2	3/4	1	1 1/4	1 1/2
Number of bolts.....	3	3	3	3 or 4	3 or 4
Diameter of Flange, inches.....	2 1/16	3 3/16	3 3/8	4 1/8	4 3/16
Each.....	\$0.40	.46	.52	.64	.78
Weight each, lbs.....	1.2	1.3	1.8	2.5	5.8
Code.....	Reengancho	Reengendro	Reengrener	Reensayado	
Size, inches.....	2	2 1/2	3	3 1/2	
Number of bolts.....	4	4	4	4	
Diameter of Flange, inches.....	5 1/16	5 5/8	6 3/16	7	
Each.....	\$1.00	1.25	1.50	1.80	
Weight each, lbs.....	8	9.5	11	13.5	
Code.....	Reensayar	Reenter	Reenvidar	Reenvite	Reepangel
Size, inches.....	4	4 1/2	5	6	7
Number of bolts.....	5	4	5	6	6
Diameter of Flange, inches.....	7 1/2	8 3/8	9 1/8	10 5/16	11 7/8
Each.....	\$2.10	2.70	3.15	3.95	5.50
Weight each, lbs.....	16	19	23.5	30.5	43.5
Code.....			Reepmaker	Reepouser	Reepsake
Size, inches.....			8	10	12
Number of bolts.....			6 or 8	9	11
Diameter of Flange, inches.....			13	15 3/4	17 1/2
Each.....			\$7.00	11.50	16.00
Weight each, lbs.....			47.5	90	113

GALVANIZED FLANGE UNIONS.

Faced. No Gasket.

Code.....	Reermouse	Reeschaaf	Reescompte	Reesperar	Reespumas
Size, inches.....	3/4	1	1 1/4	1 1/2	2
Number of bolts.....	3	3	3 or 4	3 or 4	4
Diameter of Flange, inches.....	3 3/16	3 3/8	4 1/8	4 5/16	5 1/16
Each.....	\$0.92	1.04	1.28	1.56	2.00
Weight each, lbs.....	1.3	1.8	2.5	5.8	8
Code.....	Reevesia	Reevleesch	Reexamino	Reexhaler	
Size, inches.....	2 1/2	3	3 1/2	4	
Number of bolts.....	4	4	4	5	
Diameter of Flange, inches.....	5 5/8	6 3/16	7	7 1/2	
Each.....	\$2.50	3.00	3.60	4.20	
Weight each, lbs.....	9.5	11	13.5	16	

†Carried in San Francisco only.

In Orders and Specifications give Plate Numbers and Sizes.

† **CAST IRON FLANGES.**

SCREWED. NOT DRILLED.

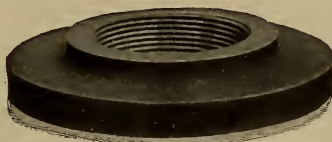

2465-C.

COMMON FLANGES. EACH.

Size of Pipe.	½	¾	1	1¼	1½	2	2½	3	3½	4	5	6	7	8	10
Outside Diameter of Flanges.	4 inches	.22	.22	.16	.16
	4½ "	.25	.25	.25	.25	.22
	5 "	.35	.30	.30	.30	.30	.35
	5½ "	.45	.45	.40	.40	.40	.35	.40
	6 "	.50	.50	.42	.40	.40	.42	.42	.50
	6½ "	.65	.60	.60	.60	.55	.50	.50	.50	.65
	7 "	.75	.75	.75	.70	.70	.62	.62	.62	.75
	7½ "	.90	.90	.90	.85	.85	.80	.80	.75	.85	.90
	8 "	1.00	1.00	1.00	.95	.95	.90	.90	.90	.90	.90
	8½ "	1.25	1.25	1.25	1.15	1.15	1.10	1.10	1.10	1.00	1.00
	9 "	1.35	1.35	1.35	1.30	1.25	1.15	1.15	1.15	1.40
	9½ "	1.90	1.90	1.75	1.75	1.60	1.60	1.50	1.50	1.50
	10 "	2.25	2.25	2.15	2.00	1.80	1.50	1.50	1.50	1.50
	11 "	2.50	2.50	2.25	2.25	2.00	1.75	1.75	2.20
12 "	3.00	3.00	2.75	2.50	2.20	2.20	2.20	2.80	
13 "	3.50	3.50	3.25	3.00	2.80	2.80	2.80	
14 "	4.00	4.00	3.75	3.50	3.25	3.25	3.25	

* **SERVICE CLAMPS OR SADDLES.**

FOR MAKING SERVICE CONNECTIONS WITH RIVETED OR WELDED WROUGHT IRON PIPE.



†2467-C.

Single Strap.

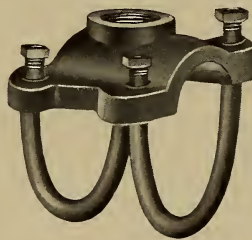

†2468-C.

Double Strap.

SINGLE STRAP—2467-C.

Code.....	Reexpecto	Reexpedier	Reexporto	Refabrics	Refachais	Refagoter	Refaisant	Refaiseur	Refaiuolo
Size, inches.....	2	2½	3	3½	4	5	6	7	8
Each.....	\$0.75	.80	1.00	1.00	1.00	1.25	1.50	1.75	2.00
Weight each, lbs.

DOUBLE STRAP—2468-C.

Code.....	Refajo	Refalsado	Refashion	Refasten	Refauchait	Refauchons	Refazedor
Size, inches.....	3	3½	4	5	6	7	8
Each.....	\$1.50	1.60	1.60	1.75	1.90	2.20	2.60
Weight each, lbs.

We make Saddles for all sizes Sheet Iron, Wrought Iron or Cast Iron Pipe, and tap and thread for any size outlet.

*In ordering state what size and kind of pipe Saddle is to be used on, and give size of tapping.

†Carried in San Francisco only.

In Orders and Specifications give Plate Numbers and Sizes.

CAST IRON RETURN BENDS.



†2470-C.

Return Bend—Close.



†2471-C.

Return Bend—Open.

RETURN BENDS—CLOSE—RIGHT HAND—2470-C.

Code.....	Refegada	Refellebat	Refendais	Referat	Refercies	Refercimus	Referciunt	Referebat
Size, inches.....	½	¾	1	1¼	1½	2	2½	3
Center to Center, inches...	1¼	1½	1¾	2¼	2½	3¼	3¾	4½
Each.....	\$0.18	.20	.22	.28	.40	.57	1.20	1.70
Weight each, lbs.....	.4	.8	1.2	2	2.6	4.5

RETURN BENDS—CLOSE—RIGHT AND LEFT HAND—2470-C.

Code.....	References	Referendar	Referiamos	Referible	Refermait	Refermasse	Refermiez	Refermions
Size, inches.....	½	¾	1	1¼	1½	2	2½	3
Center to Center, inches	1¼	1½	1¾	2¼	2½	3¼	3¾	4½
Each.....	\$0.21	.23	.26	.33	.46	.66	1.40	1.95

RETURN BENDS—OPEN—RIGHT HAND—2471-C.

Code.....	Referteira	Refertorum	Refertos	Refervebit	Referver	Refervida	Refestella
Size, inches.....	¾	1	1¼	1½	2	2½	3
Center to Center, inches.....	1⅞	2⅞	3	3½	4½	5½	6½
Each.....	\$0.26	.30	.40	.55	.80	1.35	2.20
Weight each, lbs.....	.82	1.3	2.3	4	5.7

RETURN BENDS—OPEN—RIGHT AND LEFT HAND—2471-C.

Code.....	Refestino	Refettorio	Reffkamm	Refibulabo	Refibules	Reficernt	Reficher
Size, inches.....	¾	1	1¼	1½	2	2½	3
Center to Center, inches.....	1⅞	2⅞	3	3½	4½	5½	6½
Each.....	\$0.30	.35	.46	.64	.92	1.55	2.50

†Carried in San Francisco only.

In Orders and Specifications give Plate Numbers and Sizes.

CAST IRON COUPLINGS AND Y-BENDS.

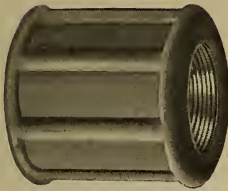

†2474-C.

Right and Left Coupling.



†2475-C.

Y Bend.

RIGHT AND LEFT COUPLINGS—2474-C.

Code.....	Reficiam	Reficiebam	Reficienda	Refigebar	Refigeris	Refigurado	Refigureis	Refilhar
Size, inches.....	1	1¼	1½	2	2½	3	3½	4
Each.....	\$0.35	.40	.55	.65	.75	1.20	1.50	2.00

Y BENDS, STRAIGHT SIZES—2475-C.

Code.....	Refilhos	Refilon	Refinabais	Refinacion	Refinado	Refinadura	Refinareis
Size, inches.....	½	¾	1	1¼	1½	2	2½
Each.....	\$0.20	.28	.34	.54	.66	.94	1.66

Code.....	Refinaria	Refinaron	Refind	Refinedly	Refinement	Refinerias	Refinery
Size, inches.....	3	3½	4	5	6	7	8
Each.....	\$2.50	3.50	4.00	7.00	9.20	15.60	22.50

Y BENDS, REDUCING SIZES—2475-C.

Code.....	Refingetis	Refingo	Refingunt	Refiriera	Refirmabo	Refirmaria	Refirmas
Size, inches.....	½	¾	1	1¼	1½	2	2½
Each.....	\$0.23	.33	.40	.62	.76	1.08	1.90

Code.....	Refirmem	Refixes	Refixistis	Refabrar	Refabile	Refabo	Refabunt
Size, inches.....	3	3½	4	5	6	7	8
Each.....	\$2.90	4.00	4.60	8.00	10.60	18.00	26.00

†Carried in San Francisco only.

In Orders and Specifications give Plate Numbers and Sizes.

CAST IRON LONG RADIUS FITTINGS.



†2478-C.
Long Radius Ell.



†2479-C.
Long Radius Double Branch Ell.



†2480-C.
Long Radius Tees.

LONG RADIUS ELLS—2478-C.

Code.....	Reflagito	Reflairer	Reflambant	Reflammas	Reflamus	Reflaret	Reflatter	Reflaturam
Size, inches.....	1	1¼	1½	2	2½	3	3½	4
Each.....	\$0.32	.40	.55	.80	1.20	2.25	3.25	3.50
Weight each, lbs.....	6.5	7.5	10.5	17	19.5

Code.....	Reflatueros	Reflaveris	Reflectado	Reflectais	Reflectir	Reflejada	Reflejando
Size, inches.....	4½	5	6	7	8	10	12
Each.....	\$5.50	6.50	8.75	13.00	17.00	30.00	40.00
Weight each, lbs.....	27	39.5	54.5	97	175

LONG RADIUS DOUBLE BRANCH ELLS—2479-C.

Code.....	Reflejar	Reflejo	Reflæssano	Reflæssare	Reflet	Refletant	Reflæxao	Reflæxe
Size, inches.....	1	1¼	1½	2	2½	3	3½	4
Each.....	\$0.64	.80	1.10	1.60	2.40	4.50	6.50	7.00
Weight each, lbs.....

Code.....	Reflæxible	Reflæxif	Reflæxiono	Reflæxity	Reflæxivio	Reflærebas	Reflæreos
Size, inches.....	4½	5	6	7	8	10	12
Each.....	\$11.00	13.00	17.50	26.00	34.00	60.00	80.00
Weight each, lbs.....

LONG RADIUS TEES—2480-C.

Code.....	Refloreret	Reflourish	Reflowers	Refluamen	Refluctuo	Refluebat	Refluement	Refluency
Size, inches.....	1	1¼	1½	2	2½	3	3½	4
Each.....	\$0.48	.60	.82	1.20	1.80	3.40	4.90	5.25
Weight each, lbs.....

Code.....	Refluente	Refluida	Refluimus	Refluirian	Reflunt	Refluxeram	Reflodies
Size, inches.....	4½	5	6	7	8	10	12
Each.....	\$8.25	9.75	13.25	19.50	25.50	45.00	60.00
Weight each, lbs.....

† Carried in San Francisco only.

In Orders and Specifications give Plate Numbers and Sizes.

† **BRANCH TEES.**



2483-C.

No. 1. For Circulation.



2484-C.

No. 2. For Circulation.



2485-C.

No. 3. For Box Coils.

All openings in Branch Tees for Circulation are tapped Right Hand.
Branch Tees for Box Coils are always tapped Left Hand in branches and Right Hand in Back Inlet.

No. of Branches.	1-Inch Branch Tees.			1¼-Inch Branch Tees.			1½-Inch Branch Tees.			2-Inch Branch Tees.		
	2½ Inches Center to Center.			3 Inches Center to Center.			3½ Inches Center to Center.			4½ Inches Center to Center.		
	1-In. or 1¼-In. Run.	1½-In. Run.	2-In. Run.	1¼-In. or 1½-In. Run.	2-In. Run.	2½-In. Run.	1½-In. or 2-In. Run.	2½-In. Run.	3-In. Run.	2-In. Run.	2½-In. or 3-In. Run.	3½-In. Run.
2	.90	1.00	1.15
3	1.05	1.15	1.35	1.65	1.90	2.40	2.70	3.45	3.80	5.25	5.75	6.25
4	1.15	1.30	1.60	2.00	2.40	2.85	3.35	4.15	4.60	6.40	7.00	7.75
5	1.35	1.45	1.85	2.40	2.90	3.55	4.00	5.00	5.50	7.65	8.50	9.25
6	1.60	1.75	2.10	2.80	3.30	3.95	4.65	5.75	6.25	8.80	9.75	10.75
7	1.90	2.20	2.45	3.20	3.90	4.20	5.25	6.50	7.25	10.60	11.75	13.00
8	2.20	2.45	2.75	3.60	4.50	4.95	5.85	7.00	7.75	11.50	12.75	14.00
9	2.65	2.90	3.40	4.30	5.25	6.15	6.50	8.25	9.00	12.25	13.50	15.00
10	3.30	4.00	4.80	5.85	6.85	7.60	9.25	10.00	13.50	15.00	16.50
11	4.50	4.80	5.00	6.25	7.25	8.00	9.75	10.75	14.25	15.75	18.00
12	4.75	5.10	5.25	6.50	7.65	8.50	10.50	11.50	15.00	16.50	20.00
13	5.50	6.00	6.00	7.00	8.25
14	7.00	7.25	6.75	7.75	9.00
15	7.50	7.75	7.50	8.50	9.75
16	8.00	8.25	8.50	9.50	10.75

1 -inch Branch Tees, 1 -inch or 1¼-inch run, are 1¾ inches Inside Diameter.
 1 " " " 1½ " " 2 " " " 2¼ " " "
 1¼ " " " " are all 2½ inches Inside Diameter.
 1½ " " " " " 2¾ " " "
 2 " " " " " 3½ " " "

Always order Branch Tees by size and number.

† Carried in San Francisco only.

In Orders and Specifications give Plate Numbers and Sizes.

CAST IRON HOOKS AND HOOK PLATES.

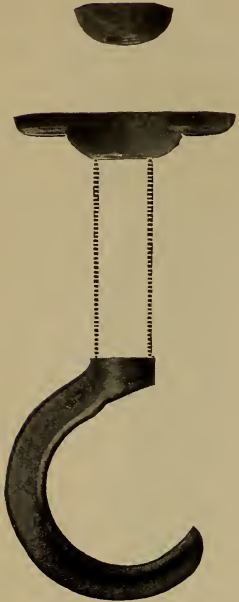

†2488-C.
Expansion Pipe Hangers
or Ring Hooks.



†2489-C.
Single Hooks.



†2490-C.
Hook Plates.

EXPANSION PIPE HANGERS—2488-C.

Code.....	Refogado	Refolding	Refolhado	Refolho	Refoment	Refoncage	Refondait	Refondiez
Size, inches.....	½	¾	1	1¼	1½	2	2½	3
Each	\$0.17	.17	.18	.19	.25	.29	.36	.44
Weight each, lbs.....6	.8	1.2	1.5	1.7	1.7	2.5

Code.....	Refont	Reforant	Reforcado	Reforgeras	Reforging	Reforma	Reformable
Size, inches.....	3½	4	4½	5	6	7	8
Each	\$0.55	.63	.90	1.12	1.35	1.80	2.25
Weight each, lbs.....	2.5	3.7	4	7.5

PARTS OF EXPANSION PIPE HANGERS.

Size, inches.....	½	¾	1	1¼	1½	2	2½	3
Plates, each	\$0.08	.08	.08	.08	.09	.09	.10	.10
Buttons, each06	.06	.06	.06	.07	.07	.08	.08
Rings, each.....	.08	.08	.12	.15	.20	.25	.30	.40

Size, inches.....	3½	4	4½	5	6	7	8
Plates, each	\$0.10	.10	.10	.10	.10	.10	.10
Buttons, each.....	.08	.08	.08	.08	.08	.08	.08
Rings, each.....	.50	.60	.85	1.00	1.25	1.70	2.15

Buttons and Rings for ½-inch to 2-inch, inclusive, are tapped for ⅜-inch pipe, larger sizes for ½-inch pipe.

HOOK PLATES—2489-C AND 2490-C.

Number of Hooks.....	1	2	3	4	5	6	7	8	9	10	11	12
For 1-inch Pipe	\$0.09	.18	.23	.26	.32	.38	.48	.59	.65	.70	.85	1.00
For 1¼-inch Pipe10	.21	.27	.32	.41	.52	.68	.80	.90	1.20	1.35	1.40
For 1½-inch Pipe.....	.15	.28	.43	.58	.72	.88	1.10	1.25	1.40	1.55	1.65	1.90
For 2-inch Pipe.....	.22	.43	.65	.90	1.15	1.35

†Carried in San Francisco only.

In Orders and Specifications give Plate Numbers and Sizes.

CEILING AND FLOOR PLATES.



2493-C.

Ceiling Plates in Halves.



†2494-C.

Ceiling Plates in One Piece.



†2495-C.

Floor Plates.

CAST IRON CEILING PLATES IN HALVES—2493-C.

Code	Reformaras	Reformarem	Reformavel	Reformist	Reformly	Reformons	Reformwerk	Refortify	Reforzabas
Size, inches.....	¾	1	1¼	1½	2	2½	3	3½	4
Each.....	\$0.22	.28	.32	.40	.50	.65	.90	1.00	1.20
Weight each, lbs	.4	.8	1.5	1.7	2	2.2	2.6

CAST IRON CEILING PLATES IN ONE PIECE—2494-C.

Code.....	Reforzando	Reforzara	Refosses	Refossuram	Refotos	Refotum	Refoturam
Size, inches.....	½	¾	1	1¼	1½	2	2½
Each.....	\$0.11	.13	.16	.18	.23	.27	.36
Weight each, lbs.....2	.3	.4	.5	.7	2

Code.....	Refoturi	Refoturos	Refouetter	Refouiller	Refoulage	Refoulait
Size, inches.....	3	3½	4	4½	5	6
Each.....	\$0.50	.55	.68	.95	.95	1.25
Weight each, lbs.....	1.4

CAST IRON FLOOR PLATES WITH COLLAR—2495-C.

Code.....	Refoulasse	Refouleur	Refounder	Refourrant	Refoveas	Refovebant
Size, inches.....	½	¾	1	1¼	1½	2
Each.....	\$0.06	.06	.08	.11	.14	.16
Weight each, lbs.....2	.3	.4	.5	.6

Code.....	Refovero	Refracted	Refragable	Refragumur
Size, inches.....	2½	3	3½	4
Each.....	\$0.24	.30	.35	.42
Weight each, lbs.....	.7	.8

This Floor Plate is made with grooves on the under side of the flange, as shown in cut, in order that it may be easily parted by a slight blow when required to be used in halves.

†Carried in San Francisco only.

In Orders and Specifications give Plate Numbers and Sizes.

† **CAST IRON DRAINAGE FITTINGS.**

SCREWED FOR IRON PIPE.

The necessity for better and safer House Drainage has induced Sanitary Engineers to recommend and adopt Wrought Iron Screwed-Jointed Pipes in place of the ordinary Cast-Iron Head-Jointed Soil Pipes, preventing thereby accumulation of Sewer Gas in houses, caused by leaky lead joints.

The following fittings are specially adapted to the Durham System of House Drainage.

These fittings have an interior shoulder, and are made with same inside capacity as the inside diameter of the Pipe, thus securing an unobstructed interior surface, allowing all solid matters to pass without choking up the pipes.

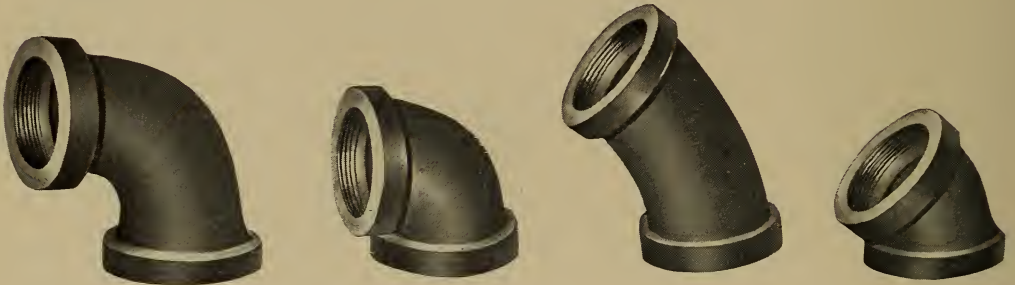

2500-C.

Long Turn Elbow.

2501-C.

Short Turn Elbow.

2502-C.

45° Long Turn Elbow.

2503-C.

45° Short Turn Elbow.

LONG TURN ELBOWS—2500-C.

Code	Refragando	Refragate	Refragia	Refrained	Refranchir	Refranes	Refranger	Refrangiez
Size, inches.....	1	1¼	1½	2	3	4	5	6
Each.....	\$0.45	.50	.60	.70	1.30	2.00	3.60	5.20

SHORT TURN ELBOWS—2501-C.

Code	Refransear	Refrappage	Refrappais	Refrappons	Refrescar	Refresco
Size, inches.....	1½	2	3	4	5	6
Each.....	\$0.50	.60	1.10	1.70	2.60	3.50

45° LONG TURN ELBOWS—2502-C.

Code	Refresh	Refreshing	Refresques	Refricabis
Size, inches.....	3	4	5	6
Each.....	\$1.45	2.25	4.00	5.75

45° SHORT TURN ELBOWS—2503-C.

Code	Refricamus	Refricaret	Refrices	Refriego	Refrieguen	Refrigerar	Refringent
Size, inches.....	1¼	1½	2	3	4	5	6
Each	\$0.40	.50	.60	1.10	1.70	2.60	3.50

Sizes differing from above can be furnished, but will be charged extra.

Galvanized Drainage Fittings double above list.

Prices for Brass Drainage fittings furnished on application.

†Carried in San Francisco only.

In Orders and Specifications give Plate Numbers and Sizes.

† **CAST IRON DRAINAGE FITTINGS.**

SCREWED FOR IRON PIPE



2506-C.
60° Elbow.

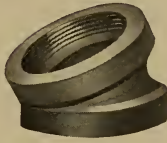

2507-C.
22½° Elbow.

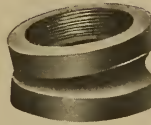

2508-C.
11¼° Elbow.

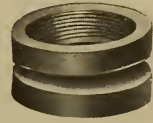

2509-C.
5⅝° Elbow.

60° ELBOWS—2506-C.

Code.....	Refringida	Refrinja	Refrisait	Refrisons	Refrita	Refritos
Size, inches.....	1½	2	3	4	5	6
Each.....	\$0.50	.60	1.10	1.70	2.60	3.50

22½° ELBOWS—2507-C.

Code.....	Refrivorum	Refrivum	Refrogner	Refrottait	Refrottons	Refudimus
Size, inches.....	1½	2	3	4	5	6
Each.....	\$0.50	.60	1.10	1.70	2.60	3.50

11¼° ELBOWS—2508-C.

Code.....	Refudisset	Refudit	Refuezran	Refugabor	Refugadora	Refugarum
Size, inches.....	1½	2	3	4	5	6
Each.....	\$0.50	.60	1.10	1.70	2.60	3.50

5⅝° ELBOWS—2509-C.

Code.....	Refugerunt	Refugiada	Refugiari	Refugiebat	Refugio	Refugiorum
Size, inches.....	1½	2	3	4	5	6
Each.....	\$0.50	.60	1.10	1.70	2.60	3.50



2512-C.
Plain Tee.



2513-C.
Increaser.

PLAIN TEES—2512-C.

Code.....	Refugisces	Refugisset	Refugor	Refugebat	Refulgemus	Refulgency	Refulsimus
Size, inches.....	1½	2	2x1½	3	3x2	4	4x2
Each.....	\$0.75	.90	.90	1.40	1.40	2.30	2.30

Code.....	Refundar	Refundebam	Refundiera	Refundio	Refundiras	Refunfuno
Size, inches.....	4x3	5	5x2	5x3	6	6x4
Each.....	\$2.30	4.00	4.00	4.00	6.00	6.00

INCREASERS—2513-C.

Code.....	Refurbish	Refusador	Refusais	Refuse	Refuseront	Refuseur	Refusons	Refusorios
Size, inches.....	3x2	4x2	4x3	5x2	5x3	5x4	6x4	6x5
Each.....	\$1.00	1.50	1.50	2.00	2.00	2.00	3.00	3.00

Sizes differing from above can be furnished, but will be charged extra.

Galvanized Drainage Fittings double above list.

Prices for Brass Drainage Fittings furnished on application.

†Carried in San Francisco only.

In Orders and Specifications give Plate Numbers and Sizes.

† **CAST IRON DRAINAGE FITTINGS.**

SCREWED FOR IRON PIPE.



2516-C.
45° Y Branch.



2517-C.
45° Y Branch.



2518-C.
45° Double Y Branch.



2519-C.
60° Y Branch.

45° Y BRANCHES—2516-C AND 2517-C.

Code.....	Refutaba	Refutacao	Refutandos	Refutarais	Refutatif	Refutatosy	Refutatura	Refutavel
Size, inches.....	1½	2	2x1½	3	3x2	4	4x2	4x3
Each.....	\$0.80	1.00	1.00	1.70	1.70	2.60	2.60	2.60
Code.....	Refuterait	Refutions	Refuto	Regabofe	Regadeira	Regadia	Regagnait	Regagniez
Size, inches.....	5	5x2	5x3	5x4	6	6x2	6x4	6x5
Each.....	\$3.50	3.50	3.50	3.50	5.50	5.50	5.50	5.50

45° DOUBLE Y BRANCHES—2518-C.

Code.....	Regagnons	Regaifa	Regain	Regajal	Regalabile	Regaladora	Regalammo	Regalaren
Size, inches.....	2	2x1½	3	3x2	4	4x2	4x3	5
Each.....	\$1.30	1.30	2.20	2.20	3.10	3.10	3.10	4.25
Code.....	Regalarla	Regalassi	Regalavate	Regalengo	Regaleurs	Regaleza	Regalice	
Size, inches.....	5x2	5x3	5x4	6	6x2	6x4	6x5	
Each.....	\$4.25	4.25	4.25	6.50	6.50	6.50	6.50	

60° Y BRANCHES—2519-C.

Code.....	Regalillos	Regaliolos	Regalista	Regalito	Regalo
Size, inches.....	2x1½	3x2	4x2	4x3	5x2
Each.....	\$1.00	1.70	2.60	2.60	4.50
Code.....	Regalolla	Regalona	Regammans	Reganarais	Regauaran
Size, inches.....	5x3	5x4	6x2	6x4	6x5
Each.....	\$4.50	4.50	7.00	7.00	7.00

Sizes differing from above can be furnished, but will be charged extra.

Galvanized Drainage Fittings double above list.

Prices for Brass Drainage Fittings furnished on application.

† Carried in San Francisco only.

In Orders and Specifications give Plate Numbers and Sizes.

†**CAST-IRON DRAINAGE FITTINGS.**

SCREWED FOR IRON PIPE.

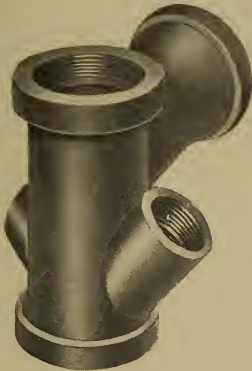

2522-C.

Closet Tee Inlet Both Sides.



2523-C.

Closet Tee Inlet Both Sides and Top.

CLOSET TEES.

Size, inches.....	3	4	5x4	6x4
Code.....	Reganona	Regardable	Regardar	Regardems
With 2-inch inlet right side only.....	\$3.00	3.50	6.50	8.00
Code.....	Regardful	Regardons	Regarniras	Regataria
With 2-inch inlet left side only.....	\$3.00	3.50	6.50	8.00
Code.....	Regatear	Regather	Regatinho	Regatoa
With 2-inch inlet both sides, 2522-C.....	\$3.50	4.00	7.00	10.00
Code.....	Regatonear	Regatoneo	Regayant	
With 2-inch inlet right side and top.....	\$5.50	7.00	9.00	
Code.....	Regazamos	Regazen	Regazonne	
With 2-inch inlet left side and top.....	\$5.50	7.00	9.00	
Code.....	Regebaris	Regedora	Regelation	
With 2-inch inlet both sides and top, 2523-C.....	\$6.00	7.50	10.00	

Sizes differing from above can be furnished but will be charged extra.

Galvanized Drainage Fittings double above list.

Prices for Brass Drainage Fittings furnished on application.

†Carried in San Francisco only.

In Orders and Specifications give Plate Numbers and Sizes.

† **CAST IRON DRAINAGE FITTINGS.**

SCREWED FOR IRON PIPE.



2526-C.

Y BRANCHES—TEE PATTERN.

Code.....	Regelmatig	Regeltest	Regelung	Regelvoll	Regelzwang	Regenbad	Regenbogen	Regencia
Size, inches.....	1½	2	3	3x2	4	4x2	4x3	5
Each.....	\$1.15	1.35	2.25	2.25	3.50	3.50	3.50	5.50
Code.....	Regendach	Regendario	Regendop	Regendorum	Regenerada	Regenerar	Regenerons	
Size, inches.....	5x2	5x3	5x4	6	6x2	6x4	6x5	
Each.....	\$5.50	5.50	5.50	7.00	7.00	7.00	7.00	



2527-C.

Three-Way Elbow.

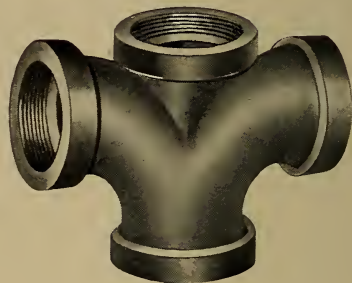

2528-C.

Cross.

THREE-WAY ELBOWS—2527-C.

Code.....	Regenesis	Regenfass	Regenfeuer	Regenfluth	Regengalle	Regengat	Regenhoek	Regenhu
Size, inches.....	1½	2	3	4	5	5x4	6	6x5
Each.....	\$1.10	1.30	2.20	3.10	4.25	4.25	6.50	6.50

CROSSES—2528-C.

Code.....	Regenjahr	Regenkappe	Regenloch	Regenlos	Regenluft	Regenmeter	Regenplant
Size, inches.....	2	3	4	5	5x4	6	6x5
Each.....	\$1.95	3.00	4.00	6.50	6.50	8.50	8.50

Sizes differing from above can be furnished, but will be charged extra.

Galvanized Drainage Fittings Double above List.

Prices for Brass Drainage Fittings furnished on application.

†Carried in San Francisco only.

In Orders and Specifications give Plate Numbers and Sizes.

† **CAST IRON DRAINAGE FITTINGS.**

SCREWED FOR IRON PIPE.

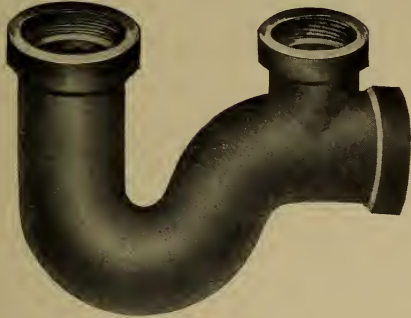

2530-C.
Half "S" or "P" Trap.

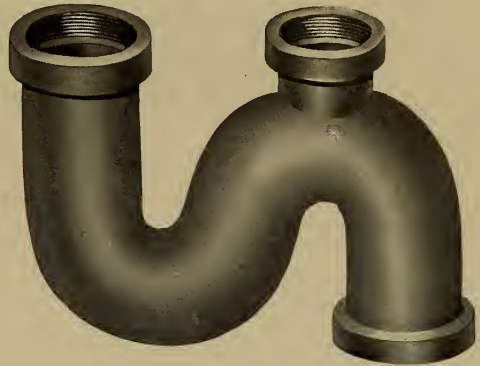

2531-C.
"S" Trap.

HALF "S" OR "P" TRAPS—2530-C.

Code	Regenpomp	Regenrinne	Regenstorm	Regensturm	Regentabas
Size, inches.....	2	3	4	5	6
Each	\$2.25	3.00	4.50	7.50	14.00

"S" TRAPS—2531-C.

Code.....	Regentag	Regente	Regentess	Regentship	Regenvlaag
Size, inches.....	2	3	4	5	6
Each.....	\$3.50	4.00	6.50	10.00	20.00

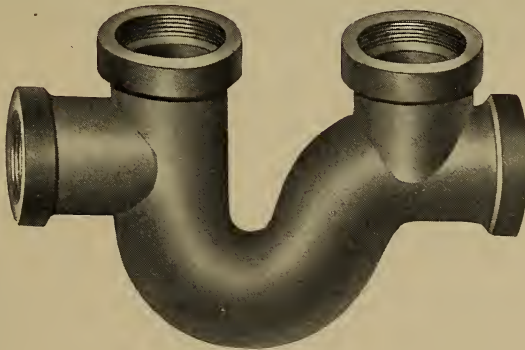

2532-C.
Running Traps.

Code.....	Regenvogel	Regenwater	Regenzeit	Regermines	Regeror
Size, inches.....	2	3	4	5	6
Each.....	\$2.40	3.50	5.00	8.00	15.00

Galvanized Drainage Fittings, double above list.

Prices for Brass Drainage Fittings furnished on application.

†Carried in San Francisco only.

In Orders and Specifications give Plate Numbers and Sizes.

CAST SOIL PIPE, SINGLE HUB.

LENGTH, 5 FEET. TAR COATED.



2550-C.

STANDARD.

Code.....	Reggested	Regestorum	Regestos	Reggendola	Reggenza
Size, inches.....	2	3	4	5	6
Per foot.....	\$0.24	.32	.40	.60	.70
Weight per length, lbs.....	17 1/2	22 1/2	32 1/2	42	52
Shipping measure, per length, cubic feet.....	1/3	7/12	1 1/12	1 5/12	1 11/12

† EXTRA HEAVY.

Code.....	Reggettone	Reggeva	Reggiamo	Reggimento	Reggitivo
Size, inches.....	2	3	4	5	6
Per foot.....	\$0.35	.65	.80	1.15	1.30
Weight per length, lbs.....	27 1/2	47 1/2	65	85	100
Shipping measure, per length, cubic feet.....	1/3	7/12	1 1/12	1 5/12	1 11/12

CAST SOIL PIPE, DOUBLE HUB.

LENGTH, 5 FEET. TAR COATED.

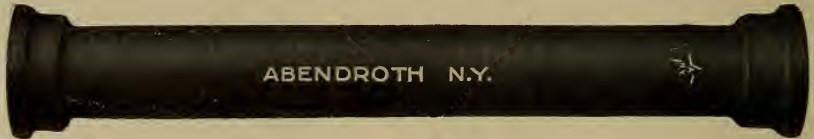

2551-C.

STANDARD.

Code.....	Reggitrice	Regiamente	Regibile	Regibilium	Regicidal
Size, inches.....	2	3	4	5	6
Per length.....	\$1.50	1.90	2.30	3.50	4.25
Weight per length, lbs.....	17 1/2	22 1/2	32 1/2	42	52
Shipping measure, per length, cubic feet.....	1/2	2/3	1	1 1/2	2

† EXTRA HEAVY.

Code.....	Regicidio	Regicismo	Regidora	Regiduria	Regiensis
Size, inches.....	2	3	4	5	6
Per length.....	\$2.05	3.55	4.30	6.25	7.25
Weight per length, lbs.....	27 1/2	47 1/2	65	85	100
Shipping measure, per length, cubic feet.....	1/2	2/3	1	1 1/2	2

We call your special attention, and we consider it of the utmost importance from a sanitary point of view, that **Our Soil Pipe is of superior quality, thoroughly sound, uniform in thickness, smooth surface inside and outside,** and can be cut without splitting.

†Carried in San Francisco only.

In Orders and Specifications give Plate Numbers and Sizes.

QUARTER BENDS.



2555-C.

STANDARD.

Code.....	Regiensium	Regierbar	Regieren	Regierung	Regificos
Size, inches.....	2	3	4	5	6
Each.....	\$0.40	.65	.80	1.50	2.00
Weight each, lbs.....	4	5½	8	10	14½

†EXTRA HEAVY.

Code.....	Regificum	Regifuge	Regifugio	Reginamus	Regignebat
Size, inches.....	2	3	4	5	6
Each.....	\$0.50	.95	1.15	2.00	2.75
Weight each, lbs.....	6	8	12	15	20

QUARTER BENDS.

WITH 2-INCH HEEL CONNECTION. STANDARD.



2556-C.

Code.....	Regild	Regillanos	Regillanum
Size, inches.....	2	†3	4
Each.....	\$0.90	1.15	1.35
Weight each, lbs.....	5	7½	10

EXTRA HEAVY.

Code.....	Regillense
Size, inches.....	4
Each.....	\$1.65
Weight each, lbs.....	16

QUARTER BENDS.

WITH 2-INCH SIDE CONNECTION.

Connection can be Furnished on either Right or Left Side.



2557-C.

Cut Shows Right Side Connection.

STANDARD.

Code.....	Regillian	Regillos
Size, inches.....	4 Right Side	4 Left Side
Each.....	\$1.85	1.85
Weight each, lbs.....	10	10

†Carried in San Francisco only.

In Orders and Specifications give Plate Numbers and Sizes.

QUARTER BENDS.

WITH DOUBLE HUBS. STANDARD.



2560-C.

Code.....	Regimber	Regimbiez	Regimbons	Regiminal	Regiminum
Size, inches.....	2	†3	4	†5	†6
Each.....	\$0.70	.95	1.10	2.00	2.50
Weight each, lbs.....	5	6½	9	12	16½

† EXTRA HEAVY.

Code.....	Regimonia	Regimur	Reginarum	Reginbert	Reginlinde
Size, inches.....	2	3	4	5	6
Each.....	\$0.80	1.25	1.45	2.50	3.25
Weight each, lbs.....	8½	12½	16	22	34

LONG QUARTER BENDS.

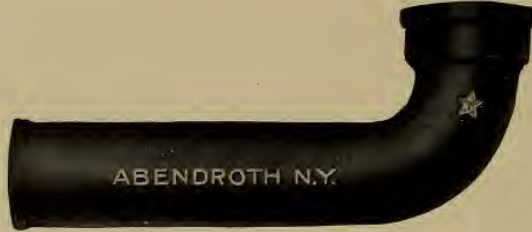

2561-C.

STANDARD.

Code.....	Reginum	Regional	Regionatim	Regione
Size, inches.....	2x18 inches clear	†2x24 inches clear	4x18 inches clear	4x24 inches clear
Each.....	\$1.10	1.50	1.75	3.00
Weight each, lbs.....	8½	10	15	18½

† EXTRA HEAVY.

Code.....	Regipeau
Size, inches.....	4x18 inches clear
Each.....	\$2.50
Weight each, lbs.....	25

† **FIFTH BENDS.**

STANDARD.



†2562-C.

Code.....	Regirar	Regisella	Regissais	Regisses	Register
Size, inches.....	2	3	4	5	6
Each.....	\$0.40	.65	.80	1.50	2.00
Weight each, lbs.....	3	4¾	6	8	11

† EXTRA HEAVY.

Code.....	Registrano	Registrava	Registries	Registros	Regitiva
Size, inches.....	2	3	4	5	6
Each.....	\$0.50	.95	1.15	2.00	2.75
Weight each, lbs.....	4¾	6¼	9½	12	16

†Carried in San Francisco only.

In Orders and Specifications give Plate Numbers and Sizes.

SIXTH BENDS.

STANDARD.

Code.....	Reglaban	Reglage	Reglant	Reglaremos	Reglaste
Size, inches.....	2	3	4	5	6
Each.....	\$0.40	.65	.80	1.50	2.00
Weight each, lbs.....	3	4¾	6	8	11

†EXTRA HEAVY.

Code.....	Reglerons	Regles	Reglescit	Reglissant	Reglisse
Size, inches.....	2	3	4	5	6
Each.....	\$0.50	.95	1.15	2.00	2.75
Weight each, lbs.....	4¾	6¾	9½	12	16



2565-C.

SIXTH BENDS.

WITH DOUBLE HUBS.

STANDARD.

Code.....	Regloirs	Reglons	Reglutines
Size, inches.....	† 2	† 3	† 4
Each.....	\$0.70	.95	1.10
Weight each, lbs.....	4	5¾	7



†2566-C.

EIGHTH BENDS.

STANDARD.

Code.....	Regnabamus	Regnabunt	Regnait	Regnamento	Regnancy
Size, inches.....	2	3	4	5	† 6
Each.....	\$0.40	.65	.80	1.50	2.00
Weight each, lbs.....	3	4¾	6	8	11

†EXTRA HEAVY.

Code.....	Regnaretis	Regnativo	Regnator	Regnatrrix	Regnaturam
Size, inches.....	2	3	4	5	6
Each.....	\$0.50	.95	1.15	2.00	2.75
Weight each, lbs.....	4¾	6¾	9½	12	16



2567-C.

EIGHTH BENDS.

WITH DOUBLE HUBS.

STANDARD.

Code.....	Regnatoros	Regnavit	Regnawast
Size, inches.....	† 2	† 3	† 4
Each.....	\$0.70	.95	1.10
Weight each, lbs.....	4	5¾	7



†2568-C.

†Carried in San Francisco only.

In Orders and Specifications give Plate Numbers and Sizes.

SIXTEENTH BENDS.

STANDARD.

Code.....	Regneront	Regnicides	Regnicola	Regnosaure	Regoado
Size, inches.....	2	†3	4	†5	†6
Each	\$0.40	.65	.80	1.50	2.00
Weight each, lbs.....	2¾	4½	5½	7½	10½

†EXTRA HEAVY.

Code.....	Regoadura	Regodeado	Regodeamus	Regodearse	Regolame
Size, inches.....	2	3	4	5	6
Each	\$0.50	.95	1.15	2.00	2.75
Weight each, lbs.....	4	6	9	11	15



2571-C.

SIXTEENTH BENDS.

WITH DOUBLE HUBS. STANDARD.

Code.....	Regolasse
Size, inches.....	†4
Each.....	\$1.10
Weight each, lbs.	6½



†2572-C.

“T” BRANCHES.

STANDARD.

Code.....	Regolativo	Regolatore	Regolavano	Regolfaban	Regolfado
Size, inches.....	2x2	†3x2	†3x3	4x2	4x3
Each	\$0.60	.90	1.00	1.20	1.30
Weight each, lbs.....	4	8	8	10	10



2573-C.

Code.....	Regolfaria	Regolfbant	Regolfes	Regomargem	Regonfle
Size, inches.....	4x4	†5x2	†5x3	†5x4	†5x5
Each	\$1.40	1.70	1.80	1.90	2.00
Weight each, lbs.....	10	14	15	15	15

Code.....	Regor	Regordeta	Regordida	Regorge	Regorgeant
Size, inches.....	†6x2	†6x3	†6x4	†6x5	†6x6
Each	\$2.50	2.60	2.70	2.80	2.90
Weight each, lbs.....	18	19	19	20	20

†EXTRA HEAVY.

Code.....	Regorjaba	Regorjamos	Regorjar	Regostabas	Regostais	Regostando
Size, inches.....	2x2	3x3	4x4	5x5	6x4	6x6
Each.....	\$0.80	1.40	1.80	2.90	3.70	3.90
Weight each, lbs.....	7	13	20	25	33	34

† Carried in San Francisco only.

In Orders and Specifications give Plate Numbers and Sizes.

“T” BRANCHES.

TAPPED FOR IRON PIPE. STANDARD.



2576-C.

Code	Regostar	Regougar	Regougo
Size, inches.....	†2x1	2x1¼	2x1½
Each.....	\$1.35	1.35	1.35
Weight each, lbs.....	4½
Code	Regoule	Regourmer	Regraciar
Size, inches.....	2x2	4x1½	4x2
Each.....	\$1.35	1.95	1.95
Weight each, lbs.....	5	9	9¾



†2577-C.

† **DOUBLE “T” BRANCHES.**

TAPPED FOR IRON PIPE. STANDARD.

Code	Regrada
Size, inches.....	2x1½
Each.....	\$1.50
Weight each, lbs.....	4¾



2578-C.

SANITARY “T” BRANCHES.

TAPPED FOR IRON PIPE. STANDARD.

Code	Regradabit	Regradabor	Regradamus	Regradaret
Size, inches.....	2x1½	†2x2	4x1½	†4x2
Each	\$1.35	1.35	1.95	1.95
Weight each, lbs....	5	6	10	11



†2579-C.

† **DOUBLE SANITARY “T” BRANCHES.**

TAPPED FOR IRON PIPE. STANDARD.

Code.....	Regradasum
Size, inches.....	2x1½
Each.....	\$1.75
Weight each, lbs

†Carried in San Francisco only.

In Orders and Specifications give Plate Numbers and Sizes.

LONG "T" BRANCHES.



†2582-C.

STANDARD.

Code.....	Regradatum
Size, inches.....	4 x 4 x 24 inches clear
Each.....	\$2.50
Weight each, lbs.....	20

LONG SANITARY "T" BRANCHES.



†2583-C.

STANDARD.

Code.....	Regradeer	Regrades	Regrador	Regral	Regrators
Size, inches.....	2x2x18 in. clear	4x2x18 in. clear	4x2x24 in. clear	4x4x18 in. clear	4x4x24 in. clear
Each.....	\$1.50	2.25	2.50	2.25	2.50
Weight each, lbs.....	9½	19	20	19½	21

SANITARY "T" BRANCHES.

STANDARD.



2584-C.

Code.....	Regrattage	Regraxar	Regredior	Regreffiez	Regreler
Size, inches.....	2 x 2	3 x 2	3 x 3	4 x 2	4 x 3
Each.....	\$0.60	1.00	1.10	1.30	1.40
Weight each, lbs.....	5	8	9	12	13
Code.....	Regresados	Regresan	Regresaste	Regresemos	Regressar
Size, inches.....	4 x 4	5 x 2	†5 x 3	5 x 4	5 x 5
Each.....	\$1.50	1.80	1.90	2.00	2.10
Weight each, lbs.....	13	17	17	18	18
Code.....	Regression	Regressive	Regressos	Regretful	Regretter
Size, inches.....	6 x 2	†6 x 3	6 x 4	†6 x 5	6 x 6
Each.....	\$2.60	2.70	2.80	2.90	3.00
Weight each, lbs.....	24	24	24	25	25

EXTRA HEAVY.

Code.....	Regriffier	Regillant	Regrimpais	Regrimper	Regronder
Size, inches.....	2 x 2	3 x 2	3 x 3	4 x 2	4 x 3
Each.....	\$0.90	1.40	1.50	1.70	1.80
Weight each, lbs.....	10	14	15	23	25
Code.....	Regrowth	Regruniais	Regrunidos	Regrunimos	Regruniria
Size, inches.....	4 x 4	5 x 2	5 x 3	5 x 4	5 x 5
Each.....	\$1.90	2.70	2.80	2.90	3.00
Weight each, lbs.....	25	30	30	32	32
Code.....	Regsam	Regsamkeit	Regsamsten	Reguacho	Reguadeiro
Size, inches.....	6 x 2	6 x 3	6 x 4	6 x 5	6 x 6
Each.....	\$3.60	3.70	3.80	3.90	4.00
Weight each, lbs.....	42	43	43	45	45

†Carried in San Francisco only.

In Orders and Specifications give Plate Numbers and Sizes.



UPRIGHT "Y" BRANCHES.

OR COMBINATION "Y" AND EIGHTH BEND.
STANDARD.

Code.....	Rehinder
Size, inches.....	4x4
Each.....	\$2.25
Weight each, lbs.....

† **SANITARY "T" BRANCHES.**

WITH 2-INCH SIDE CONNECTION.

Connection can be Furnished on either Right or Left Side.



†2587-C.

Cut Shows Right Side Connection.

STANDARD.

Code.....	Reguante	Regueifa	Reguengo
Size, inches.....	3x3 Right Side	4x2 Right Side	4x4 Right Side
Each	\$2.10	2.30	2.50
Weight each, lbs.....	10	13	14

Code.....	Regueras	Reguerdon	Regulable
Size, inches.....	3x3 Left Side	4x2 Left Side	4x4 Left Side
Each	\$2.10	2.30	2.50
Weight each, lbs.....	10	13	14

DOUBLE SANITARY "T" BRANCHES.

STANDARD.



2588-C.

Code.....	Regulabunt	Regulado	Regulandos	Regularite	Regulating
Size, inches.....	2x2	3x2	3x3	4x2	4x3
Each.....	\$1.20	1.60	1.75	1.95	2.10
Weight each, lbs...	8	10½	11	16½	17

Code.....	Regulator	Regulatura	Regulier	Regung	Regungslos
Size, inches.....	4x4	5x2	†5x3	5x4	†5x5
Each.....	\$2.25	2.70	2.85	3.00	3.15
Weight each, lbs...	18	24	24½	25	26

Code.....	Regurgitor	Regustabor	Regustamur	Regustarem	Regustor
Size, inches.....	†6x2	†6x3	6x4	†6x5	6x6
Each	\$3.50	3.65	3.80	3.95	4.10
Weight each, lbs	35	35½	35½	36	37

†**EXTRA HEAVY.**

Code.....	Rehacemos	Rehacer	Rehagais	Rehash	Rehaige	Rehearing	Rehearsal	Rehechas
Size, inches.....	2x2	3x2	3x3	4x2	4x3	4x4	5x2	5x3
Each.....	\$1.50	2.10	2.25	2.70	2.85	3.00	3.80	3.95
Weight each, lbs...	12	19	20	30	30	32	39	40

Code	Rehecho	Reheleados	Rehelm	Rehenchido	Rehiletas	Rehjagd	Rehleder
Size, inches.....	5x4	5x5	6x2	6x3	6x4	6x5	6x6
Each.....	\$4.10	4.25	4.90	5.05	5.20	5.35	5.50
Weight each, lbs.....	41	42	56	57	58	59	60



2589-C.

HORIZONTAL "T-Y" BRANCHES.

STANDARD.

Code.....	Rehob
Size, inches.....	4x4
Each	\$2.50
Weight each, lbs.....

† Carried in San Francisco only.

In Orders and Specifications give Plate Numbers and Sizes.

“Y” BRANCHES.



2592-C.

STANDARD.

Code.....	Rehoboam	Rehoboth	Rehogaban	Rehogadas	Rehogamos
Size, inches.....	2x2	3x2	3x3	4x2	4x3
Each.....	\$0.60	1.00	1.10	1.30	1.40
Weight each, lbs...	5	8	9	12	13
Code.....	Rehogaste	Rehogo	Rehogue	Rehollamos	Rehollar
Size, inches.....	4x4	5x2	5x3	5x4	5x5
Each.....	\$1.50	1.80	1.90	2.00	2.10
Weight each, lbs...	13	17	17	18	18
Code.....	Rehoyar	Rehpsosten	Rehschnur	Rehschrot	Rehuiamos
Size, inches.....	6x2	†6x3	6x4	†6x5	6x6
Each.....	\$2.60	2.70	2.80	2.90	3.00
Weight each, lbs...	24	24	24	25	25

† EXTRA HEAVY.

Code.....	Rehuias	Rehumecter	Rehumedece	Rehumilier	Rehundidas	Rehundimos	Rehundir	Rehurta
Size, inches.....	2x2	3x2	3x3	4x2	4x3	4x4	5x2	5x3
Each.....	\$0.90	1.40	1.50	1.70	1.80	1.90	2.70	2.80
Weight each, lbs....	10	14	15	23	25	25	30	30
Code.....	Rehurtara	Rehusaste	Rehuvais	Rehwild	Rehziege	Reibahle	Reibbar	
Size, inches.....	5x4	5x5	6x2	6x3	6x4	6x5	6x6	
Each.....	\$2.90	3.00	3.60	3.70	3.80	3.90	4.00	
Weight each, lbs.....	32	32	42	43	43	45	45	

INVERTED “Y” BRANCHES.



2593-C.

STANDARD.

Code.....	Reibhammer	Reibolzes
Size, inches.....	†3x2	4x2
Each.....	\$1.25	1.50
Weight each, lbs.....	8	11

† EXTRA HEAVY.

Code.....	Reiblappen
Size, inches.....	4x2
Each.....	\$2.00
Weight each, lbs.....	18



† 2594-C.

† **DOUBLE INVERTED “Y” BRANCHES**

STANDARD.

Code.....	Reibscheit
Size, inches.....	4x2
Each.....	\$2.00
Weight each, lbs.....	13½

†Carried in San Francisco only.

In Orders and Specifications give Plate Numbers and Sizes.

HALF "Y" BRANCHES.

STANDARD.



2597-C.

Code.....	Reibstein	Reibzeug	Reich	Reichlich	Reichsaar
Size, inches.....	2x2	†3x2	†3x3	4x2	4x3
Each.....	\$0.60	1.00	1.10	1.30	1.40
Weight each, lbs.....	4½	6	6½	9	10

Code.....	Reichsacht	Reichsadel	Reichsbank	Reichserbe	Reichsfuss
Size, inches.....	4x4	†5x2	†5x3	†5x4	†5x5
Each.....	\$1.50	1.80	1.90	2.00	2.10
Weight each, lbs.....	10	13	14½	14	14

Code.....	Reichsgeld	Reichsgraf	Reichsherr	Reichsmark	Reichspost
Size, inches.....	†6x2	†6x3	†6x4	†6x5	†6x6
Each.....	\$2.60	2.70	2.80	2.90	3.00
Weight each, lbs.....	15	15½	16	16	16

†EXTRA HEAVY.

Code.....	Reichsrath	Reichstag	Reichsvogt	Reichsvolk	Reichthum	Reiculatorum	Reiculus	Reiculum
Size, inches.....	2x2	3x2	3x3	4x2	4x3	4x4	5x2	5x3
Each.....	\$0.90	1.40	1.50	1.70	1.80	1.90	2.70	2.80
Weight each, lbs.....	8	10	11	17	18	18	25	25

Code.....	Reideras	Reidora	Reifbiege	Reifbinder	Reifcheu	Reifeis	Reifmesser
Size, inches.....	5x4	5x5	6x2	6x3	6x4	6x5	6x6
Each.....	\$2.90	3.00	3.60	3.70	3.80	3.90	4.00
Weight each, lbs.....	26	26	35	36	36	37	37

DOUBLE "Y" BRANCHES.

STANDARD.



2598-C.

Code.....	Reifmonat	Reifpunkt	Reifrock	Reifspiel
Size, inches.....	2x2	†3x2	3x3	4x2
Each.....	\$1.20	1.60	1.75	1.95
Weight each, lbs.....	8	10½	11	17½

Code.....	Reifsprung	Reifstab	Reigenhaft	Reigenlauf
Size, inches.....	†4x3	4x4	†5x4	†5x5
Each.....	\$2.10	2.25	3.00	3.15
Weight each, lbs.....	18	18	25	26

Code.....	Reigerbos	Reigerhals	Reigerhut	Reigervalk	Reigned
Size, inches.....	†6x2	†6x3	†6x4	†6x5	†6x6
Each.....	\$3.50	3.65	3.80	3.95	4.10
Weight each, lbs..	35½	36	36½	37	37

†EXTRA HEAVY.

Code.....	Reihensaat	Reiherfalk	Reillere	Reiltopp	Reimao	Reimarie	Reimarus	Reimbark	Reimbody
Size, inches.....	2x2	3x3	4x2	4x4	5x3	5x4	5x5	6x4	6x6
Each.....	\$1.50	2.25	2.70	3.00	3.95	4.10	4.25	5.20	5.50
Weight each, lbs..	12	20	30	32	41	42	42	58	60

†Carried in San Francisco only.

In Orders and Specifications give Plate Numbers and Sizes.

DOUBLE HALF "Y" BRANCHES.

STANDARD.



2601-C.

Code.....	Reimbranca	Reimbrar	Reimburse	Reimerling
Size, inches.....	2x2	†3x2	†3x3	4x2
Each.....	\$1.20	1.60	1.75	1.95
Weight each, lbs.....	7¼	8½	10	12¼
Code.....	Reimfall	Reimfrei	Reimkunst	Reimmass
Size, inches.....	†4x3	4x4	†5x2	†5x4
Each.....	\$2.10	2.25	2.70	3.00
Weight each, lbs.....	12½	13¼	13½	17
Code.....	Reimmerge	Reimoso	Reimpiego	Reimpor
Size, inches.....	†5x5	†6x2	†6x4	†6x6
Each.....	\$3.15	3.50	3.80	4.10
Weight each, lbs.....	18	18½	20½	38

†EXTRA HEAVY.

Code.....	Reimposant	Reimpress	Reimprimir	Reimprint	Reimprison	Reimputer	Reimsatz	Reimsillbe
Size, inches.....	2x2	3x2	3x3	4x2	4x3	4x4	5x2	5x3
Each.....	\$1.50	2.10	2.25	2.70	2.85	3.00	3.80	3.95
Weight each, lbs. ...	10	18	20	21½	21	21½	26¼	30
Code.....	Reimspruch	Reimsucht	Reimweise	Reimwort	Reimzwang	Reinado	Reinate	
Size, inches.....	5x4	5x5	6x2	6x3	6x4	6x5	6x6	
Each.....	\$4.10	4.25	4.90	5.05	5.20	5.35	5.50	
Weight each, lbs.	32	35	36	39	44	47	49	

DOUBLE "T" BRANCHES OR CROSS HEADS.

STANDARD.



2602-C.

Code.....	Reinazgo	Reincense	Reincidido	Reincitant	Reinnease
Size, inches.....	2x2	3x2	†3x3	4x2	†4x3
Each.....	\$1.00	1.35	1.50	1.50	1.65
Weight each, lbs..	5	9	10	11½	12
Code.....	Reincur	Reindicata	Reinduce	Reine	Reinemos
Size, inches.....	4x4	†5x4	†5x5	†6x2	†6x6
Each.....	\$1.80	2.55	2.70	2.90	3.50
Weight each, lbs..	12	15	16	22	24



2603-C.

VENTILATING BRANCHES.

STANDARD.

Code	Reinertrag	Reinnettes
Size, inches	2x2	4x2
Each.....	\$0.80	1.50
Weight each, lbs.....	4¾	10

†Carried in San Francisco only.

In Orders and Specifications give Plate Numbers and Sizes.

†“T” CLEANOUTS.

WITH ROUND HAND HOLE AND COVER. STANDARD.



†2606-C.

Code.....	Reinfecter	Reinflachs	Reinflame	Reinform	Reinfund
Size, inches.....	2	3	4	5	6
Each	\$0.80	1.20	1.50	2.00	3.00
Weight each, lbs.....	6¼	6½	11¼	15¼	20

EXTENSION PIECES.



2607-C.



2608-C.

STANDARD.

Code	Reinforcing	Reinheit	Reinherzig	Reinhumer	Reinicola
Size, inches	† 2x4	2x6	2x8	† 2x10	† 2x12
Each	\$0.30	.40	.45	.55	.65
Weight each, lbs.....	3½	4	4½	5½	6

Code.....	Reinigen	Reinless	Reinlich	Reinnudel	Reinol	Reinquire
Size, inches.....	† 3x4	3x6	† 3x8	† 3x10	† 3x12	† 4x4
Each.....	\$0.50	.60	.70	.80	.90	.65
Weight each, lbs.....	5	5½	6½	7½	8	6

Code	Reinserer	Reinseriez	Reinsert	Reinspect	Reinspiner	Reinst
Size, inches.....	† 4x6	† 4x8	† 4x10	† 4x12	† 5x6	† 6x6
Each	\$0.75	.85	1.00	1.15	.95	1.20
Weight each, lbs	7	8	9½	10½	9	12

†EXTRA HEAVY.

Code.....	Reinstitue	Reinstruct	Reinsure	Reinsurger	Reintegrar	Reinthrone	Reintrante	Reinundate	Reinventer
Size, inches.....	2x6	2x8	2x10	3x6	3x8	3x10	4x6	4x8	4x10
Each	\$0.60	.70	.80	1.00	1.10	1.20	1.30	1.40	1.50
Weight each, lbs...	5½	6	7	10	12	14	14	16	19

†Carried in San Francisco only.

In Orders and Specifications give Plate Numbers and Sizes.

OFFSETS.

STANDARD.



2611-C.

Code.....	Reinvestir	Reinvitabo	Reinvitait	Reinvito
Size, inches.....	2 x 2	2 x 4	2 x 6	2 x 8
Each	\$0.45	.50	.60	.70
Weight each, lbs.....	3	3½	4½	5

Code.....	Reinvolve	Reinwald	Reinzucht	Reisacker
Size, inches.....	2 x 10	2 x 12	2 x 14	2 x 16
Each	\$0.80	.90	1.00	1.25
Weight each, lbs.....	5½	6	7	7½

Code.....	Reisammer	Reisbau	Reisbedden	Reisbesen	Reisblad	Reisboek	Reisbrief	Reisbrot
Size, inches.....	†3 x 4	†3 x 6	†3 x 8	†3 x 10	†3 x 12	†4 x 2	4 x 4	4 x 6
Each	\$0.90	1.00	1.10	1.25	1.40	.85	1.00	1.15
Weight each, lbs.....	5½	7	8	9	9½	8½	9	9½

Code.....	Reisbund	Reisbutus	Reisdecken	Reisebild	Reisebuch	Reiseecke	Reisegeld	Reisehut
Size, inches.....	4 x 8	4 x 10	4 x 12	4 x 14	4 x 16	4 x 18	4 x 20	†5 x 4
Each	\$1.30	1.45	1.60	1.80	2.00	2.25	2.50	1.70
Weight each, lbs.....	12	13	15	17	19	21	23	11

Code.....	Reisejacke	Reisekappe	Reisekarte	Reisekleid	Reiselade	Reiselied	Reiselust
Size, inches.....	†5 x 6	†5 x 8	†5 x 12	†6 x 4	†6 x 6	†6 x 8	†6 x 12
Each	\$1.90	2.10	2.50	2.00	2.25	2.50	3.00
Weight each, lbs.....	12½	15	20	14	18	22	27

†EXTRA HEAVY.

Code.....	Reiseonkel	Reisepass	Reisern	Reisesack	Reisestaub	Reisestock	Reisetag	Reisete
Size, inches.....	2 x 2	2 x 4	2 x 6	2 x 8	2 x 10	2 x 12	2 x 14	2 x 16
Each	\$0.75	.90	1.00	1.10	1.20	1.30	1.45	1.60
Weight each, lbs.....	6½	7	8	9	10	11	12	13

Code.....	Reisetsp	Reiseuhr	Reisewagen	Reiseweg	Reisewerk	Reisewurth	Reisezoll	Reisfeld
Size, inches.....	3 x 4	3 x 6	3 x 8	3 x 10	3 x 12	4 x 2	4 x 4	4 x 6
Each	\$1.25	1.35	1.50	1.65	1.80	1.25	1.40	1.60
Weight each, lbs.....	11	13	15	17	19	12	13	14

Code.....	Reisgenoot	Reisgenpal	Reisgenpit	Reisgenpuz	Reisgenqui	Reisgenros	Reisgenrum	Reisgenure
Size, inches.....	4 x 8	4 x 10	4 x 12	4 x 14	4 x 16	4 x 20	6 x 6	6 x 12
Each	\$1.80	2.00	2.25	2.50	2.75	3.75	3.25	4.00
Weight each, lbs.....	15½	19	23	26	30	34	32	51

†Carried in San Francisco only.

†“T” SADDLE HUBS.

STANDARD.



†2614-C.

Code.....	Reisgerste	Reisgezel	Reisgoed	Reisigholz
Size, inches.....	4x2	4x3	4x4	5x2
Each.....	\$0.60	.60	.60	.75
Weight each, lbs.....	3¼	3½	3¼	3¼

Code.....	Reisholz	Reisje	Reiskist	Reiskoffer	Reiskorn
Size, inches.....	5x3	5x4	6x2	6x3	6x4
Each.....	\$0.75	.75	1.10	1.10	1.10
Weight each, lbs.....	3¼	5½	3¼	3¼	6

†“Y” SADDLE HUBS.

STANDARD.



†2615-C.

Code.....	Reiskosten	Reiskuchen	Reislauf	Reismaal	Reismakker
Size, inches.....	2x2	4x2	4x3	4x4	6x2
Each.....	\$0.35	.70	.70	.70	1.25
Weight each, lbs.....	2½	2½	4¼	6¼	2½

†HALF “Y” SADDLE HUBS.

STANDARD.



†2616-C.

Code.....	Reismehl	Reispaard	Reispapier
Size, inches.....	4x2	4x3	4x4
Each.....	\$0.70	.70	.70
Weight each, lbs.....	2¼	4¼	5

†PIPE BANDS.

WITH “T” BRANCH. STANDARD.



†2617-C.

Code.....	Reispet	Reisplan	Reissaus	Reissbrett
Size, inches.....	4x2	4x3	4x4	5x2
Each.....	\$1.25	1.25	1.25	1.75
Weight each, lbs.....

Code.....	Reissendes	Reissfeder	Reiss shaken	Reissimo	Reisskohle
Size, inches.....	5x3	5x4	5x5	6x2	6x3
Each.....	\$1.75	1.75	1.75	2.25	2.25
Weight each, lbs.....

†Carried in San Francisco only.

In Orders and Specifications give Plate Numbers and Sizes.

† **INCREASERS.**

STANDARD.



†2620-C.

Code.....	Reisslatte	Reissnadel	Reissuable
Size, inches.....	2x3	2x4	2x5
Each.....	\$0.70	.90	1.15
Weight each, lbs.....	3	6½	5¼
Code.....	Reissue	Reisszahn	Reisszeng
Size, inches.....	3x4	3x5	4x6
Each.....	\$0.90	1.15	1.25
Weight each, lbs.....	5	6	11¼

REDUCERS.

STANDARD.



2621-C.

Code.....	Reistasch	Reistruhe	Reitbahn	Reitelholz	Reitendes
Size, inches.....	3x2	4x2	4x3	5x2	†5x3
Each.....	\$0.50	.65	.65	.85	.85
Weight each, lbs.....	3	4	4	5½	6
Code.....	Reitesel	Reitgaul	Reitgurtes	Reithengst	Reithose
Size, inches.....	5x4	†6x2	†6x3	6x4	†6x5
Each.....	\$0.85	1.00	1.00	1.00	1.00
Weight each, lbs.....	6	7½	8	8½	8

† **EXTRA HEAVY.**

Code.....	Reithronon	Reitjacke	Reitjunge	Reitkissen	Reitkleid
Size, inches.....	3x2	4x2	4x3	5x2	5x3
Each.....	\$0.60	.75	.75	1.10	1.10
Weight each, lbs.....	4	5	6	7½	8
Code.....	Reitkunst	Reitlehen	Reitochs	Reitorado	Reitoral
Size, inches.....	5x4	6x2	6x3	6x4	6x5
Each.....	\$1.10	1.35	1.35	1.35	1.35
Weight each, lbs.....	8	10	10½	11	11



2622-C.

VENTILATING CAPS.

STANDARD.

Code.....	Reitpost	Reitrock	Reitross
Size, inches.....	2	†3	4
Each.....	\$0.40	.60	.80
Weight each, lbs.....	3	3¾	8

†Carried in San Francisco only.

In Orders and Specifications give Plate Numbers and Sizes.

†TRAP COVERS.

STANDARD.



†2625-C.

Code.....	Reitsattel	Reitstall	Reitstock	Reittasche	Reittenne
Size, inches.....	2	3	4	5	6
Each	\$0.12	.16	.20	.30	.40
Weight each, lbs.....	1	1½	1¾	1¾	2

EXTRA HEAVY.

Code.....	Reitvogt	Reitwegen	Reitzug	Reixelo	Reizbares
Size, inches.....	2	3	4	5	6
Each	\$0.18	.25	.30	.40	.50
Weight each, lbs.....

SINGLE HUBS.

STANDARD.



2627-C.

Code.....	Reizend	Reizung	Rejailer
Size, inches.....	2	3	4
Each	\$0.30	.50	.65
Weight each, lbs	2½	3½	4

DOUBLE HUBS.

STANDARD.



2628-C.

Code.....	Rejalgar	Rejaser	Rejaunir	Rejectabis	Rejectavit
Size, inches.....	2	3	4	5	6
Each	\$0.30	.55	.70	1.00	1.20
Weight each, lbs.....	3	4	6	8	10

†EXTRA HEAVY.

Code.....	Rejection	Rejement	Rejitar	Rejetable	Rejetais
Size, inches.....	2	3	4	5	6
Each	\$0.45	.70	.85	1.35	1.60
Weight each, lbs.....	4½	7	8	11	14

STRAIGHT SLEEVES.

STANDARD.



2629-C.

Code.....	Rejotonner	Rejotons	Rejetteras	Rejicula	Rejillas
Size, inches.....	2	3	4	5	6
Each	\$0.30	.55	.70	1.00	1.20
Weight each, lbs.....	2¾	4	5	6½	6¾

† Carried in San Francisco only.

In Orders and Specifications give Plate Numbers and Sizes.

PIPE PLUGS.

STANDARD.



2632-C.

Code.....	Rejitaba	Rejitaras	Rejitaste	Rejoicing	Rejoignons
Size, inches.....	2	†3	4	†5	†6
Each.....	\$0.15	.25	.30	.40	.50
Weight each, lbs.....	1¼	1¾	3	4½	5½

PIPE RESTS.

STANDARD.



†2633-C.

Code.....	Rejoinder
Size, inches.....	4
Each.....	\$0.50
Weight each, lbs.....	4

CAST IRON DRUM TRAPS.

WITH NICKEL-PLATED BRASS TRAP SCREW.



†2640-C.

INLET AND OUTLET 2-INCH HUB OPENINGS FOR CAST SOIL PIPE.

Distance from center of inlet or outlet to top of trap, inches.....	3½
“ “ “ “ bottom of trap, inches.....	5½

Code	Rejoltng	Rejoncillo
Style.....	Painted	Enameled Inside
Each	\$4.50	5.75
Weight each, lbs.....

NOTE:—The above Drum Trap is so constructed that a very deep Water Seal is obtained and the center of all openings are kept on a line. A clean-out screw on the inside can be removed in case of stoppage, by first removing the Trap Screw and then the clean-out screw access is had to all parts of the Trap, and the inlet and outlet pipes can be reached for rodding.

†Carried in San Francisco only.

In Orders and Specifications give Plate Numbers and Sizes.

“S” TRAPS.

STANDARD.



2645-C.

Code.....	Rejoneadas	Rejonear	Rejoneo
Size, inches.....	2	†3	†4
Each.....	\$0.80	1.25	1.75
Weight each, lbs.....	5½	10	19

†**THREE-QUARTER “S” TRAPS.**

STANDARD.



†2646-C.

Code.....	Rejourned	Rejude	Rejuela
Size, inches.....	2	3	4
Each.....	\$0.80	1.25	1.75
Weight each, lbs.....	5½	10	19

HALF “S” OR “P” TRAPS.

STANDARD.



2647-C.

Code.....	Rejuvenate	Rejuvenize	Rekindle
Size, inches.....	2	†3	†4
Each.....	\$0.80	1.25	1.75
Weight each, lbs.....	5½	10	19

†EXTRA HEAVY.

Code.....	Relabendos	Relabimur	Relache
Size, inches.....	2	3	4
Each.....	\$1.25	2.00	2.75
Weight each, lbs.....	9	18	28

“S” TRAPS.

WITH HAND HOLE AND COVER. STANDARD.



2648-C.

Code.....	Relachions	Relacionar	Relaesus	Relaessiez	Relajabas
Size, inches.....	†2	†3	4	†5	†6
Each.....	\$1.00	1.50	2.00	3.75	4.75
Weight each, lbs...	6	11	20½	28	38

†Carried in San Francisco only.

In Orders and Specifications give Plate Numbers and Sizes.



†2651-C.

†THREE-QUARTER "S" TRAPS.

WITH HAND HOLE AND COVER. STANDARD.

Code.....	Relajadora	Relajantes	Relajaran
Size, inches.....	3	4	5
Each.....	\$1.50	2.00	3.75
Weight each, lbs.....	11	20½	28



2652-C.

HALF "S" OR "P" TRAPS.

WITH HAND HOLE AND COVER. STANDARD.

Code.....	Relamber	Relambido	Relamemos	Relamiera
Size, inches.....	†2	†3	4	†5
Each.....	\$1.00	1.50	2.00	3.75
Weight each, lbs.	6	11	20½	28



†2653-C.

†RUNNING TRAPS.

WITH HAND HOLE AND COVER. STANDARD.

Code.....	Relamiseses	Relampejar	Relampo
Size, inches.....	2	3	4
Each.....	\$1.00	1.50	2.00
Weight each, lbs.....	6½	12	21½

Code.....	Relancait	Relance
Size, inches.....	5	6
Each.....	\$3.75	4.75
Weight each, lbs.....	29	39



2654-C.

"S" TRAPS.

WITH 2-INCH TOP VENT. STANDARD.

Code.....	Relanceras	Relancerons	Relanzadas
Size, inches.....	2x2	†3x2	4x2
Each.....	\$1.25	1.75	2.25
Weight each, lbs.....	6	11	20

†Carried in San Francisco only.



†2657-C.

†**THREE-QUARTER "S" TRAPS.**

WITH 2-INCH TOP VENT. STANDARD.

Code.....	Relanzar	Relanzo
Size, inches.....	2x2	4x2
Each	\$1.25	2.25
Weight each, lbs.....	6	20



2658-C.

HALF "S" OR "P" TRAPS.

WITH 2-INCH TOP VENT. STANDARD.

Code.....	Relapsable	Relapsia	Relapsioni
Size, inches.....	2x2	† 3x2	4x2
Each	\$1.25	1.75	2.25
Weight each, lbs.....	6	11	20

†**EXTRA HEAVY.**

Code.....	Relapso	Relargage
Size, inches.....	2x2	4x2
Each	\$1.75	3.25
Weight each, lbs.....	10	32



2659-C.

RUNNING TRAPS.

WITH ONE HUB VENT. STANDARD.

Code.....	Relargir	Relargites	Relatador
Size, inches.....	† 2x2	† 3x2	† 3x3
Each	\$1.25	1.75	1.85
Weight each, lbs.....	7½	12½	13½

Code.....	Relatando	Relatarais	Relateron
Size, inches.....	4x4	† 5x5	† 6x6
Each	\$2.50	4.50	5.50
Weight each, lbs.....	23	31	40

†**EXTRA HEAVY.**

Code.....	Relational	Relatively	Relativos	Relatores
Size, inches.....	3x3	4x4	5x4	6x4
Each.....	\$2.60	3.50	5.25	6.75
Weight each, lbs...	23	36	53	76



2660-C.

RUNNING TRAPS.

WITH TWO HUB VENTS. STANDARD.

Code.....	Relatrix	Relatter
Size, inches.....	4x4	† 6x4
Each	\$3.25	6.00
Weight each, lbs.....	27	43

†Carried in San Francisco only.

In Orders and Specifications give Plate Numbers and Sizes.

†“S” TRAPS.

WITH 2-INCH HEEL AND HAND HOLE. STANDARD.



†2663-C.

Code.....	Relavabo
Size, inches.....	4
Each.....	\$2.50
Weight each, lbs.....	22

“S” TRAPS.

WITH 2-INCH HEEL. STANDARD.

Code.....	Relavais
Size, inches.....	4
Each.....	\$2.25
Weight each, lbs.....	21

†HALF “S” OR “P” TRAPS.

WITH 2-INCH HEEL AND HAND HOLE. STANDARD.



†2664-C.

Code.....	Relavaras
Size, inches.....	4
Each.....	\$2.50
Weight each, lbs.....	22

HALF “S” OR “P” TRAPS.

WITH 2-INCH HEEL. STANDARD.

Code.....	Relavaturu
Size, inches.....	4
Each.....	\$2.25
Weight each, lbs.....	21

†HALF “S” OR “P” TRAPS.

WITH 1/2 HAND HOLE AND COVER AND 2-INCH SIDE CONNECTION RIGHT OR LEFT.

STANDARD.



†2665-C.

Code.....	Relavavit	Relavavose
Size, inches.....	4 Right hand	4 Left hand
Each.....	\$3.00	3.00
Weight each, lbs.....	22	22

Cut Shows Right Side Connection.

†Carried in San Francisco only.

In Orders and Specifications give Plate Numbers and Sizes.

ACME BACK WATER SEWER VALVES.

FOR CAST IRON SOIL PIPE WITH CONCAVE-CONVEX OSCILLATING BRASS CLAPPER.

A perfect seal against sewer gas, back water and vermin.

The form of the Clapper and the manner of sealing and supporting it are important features not found in any other Back Water Valve.

The Oscillating Clapper makes it self-closing and renders it impossible for anything to find lodgment either on clapper or on seat.

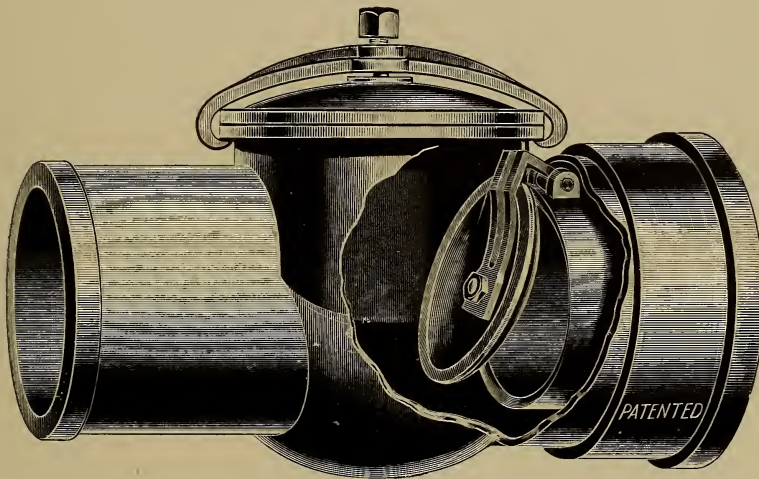

2670-C.

STANDARD.

Code.....	Relavawan	Relavawell	Relavawet
Size, inches.....	4	5	6
Length over all, inches.....	13	15	15¾
Each.....	\$5.50	7.50	9.50
Weight each, lbs.....	21	33	42

EXTRA HEAVY.

Code.....	Relavaworn	Relavawum	Relavawybe
Size, inches.....	4	5	6
Length over all, inches.....	13	15	15¾
Each.....	\$6.50	8.50	10.50
Weight each, lbs.....	29	41	58

In Orders and Specifications give Plate Numbers and Sizes.

SISSON INSERTABLE JOINTS.

FOR CAST IRON SOIL PIPE.

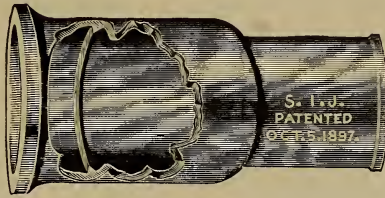

2668-C.

Length, 11½ Inches.

STANDARD.

Code.....	Relaver	Relaxable	Relaxabor	Relaxacao	Relaxado
Size, inches.....	2	3	4	5	6
Each.....	\$1.40	1.50	1.80	2.10	2.60
Weight each, lbs.....	6¼	9	12¾	14¾	17¾

†EXTRA HEAVY.

Code.....	Relaxandas	Relaxante	Relaxarem	Relaxative	Relaxamns
Size, inches.....	2	3	4	5	6
Each.....	\$1.50	1.70	2.00	2.30	2.80
Weight each, lbs.....	9	13	15¾	21	24¼

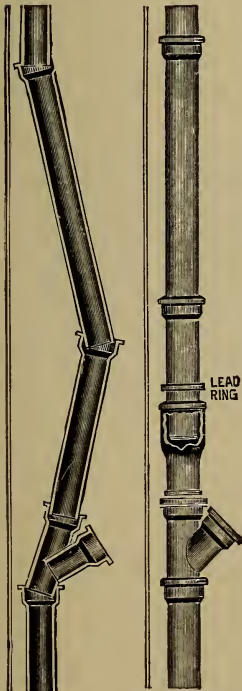

Old Method. Best Method. "Our Way."

When after testing a line of pipes, a defective length or fitting was found and had to be taken out, it has been necessary heretofore to break out a length, and often more, leaving at least three joints to be sprung into place, as shown in cut, or to cut short lengths and use double hubs, etc., but with the Sisson Insertable Joint all that is required is to cut out of soil pipe the length of fitting it is desired to insert and 11½ inches for the Sisson Joint, and slip the lead ring which accompanies it over the pipe above, push joint up as far as possible, as shown in illustration, place "Y" or other fitting in the hub below and drop joint down into it. The lead ring will drop into the Joint and rest upon the shoulder inside; a little oakum is then placed on top of the lead ring, the lead poured on, and the work is complete. It is not necessary to disturb the pipe above or below to get the slack needed, saving the extra amount of trouble and annoyance of springing pipe into place

†Carried in San Francisco only.

In Orders and Specifications give Plate Numbers and Sizes.

GAS PIPE HOOKS.



2671-C.

PLUMBERS' HOOKS.

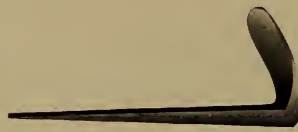

†2672-C.

TINNED PIPE STRAPS.



2673-C.

GAS PIPE HOOKS—2671-C.

Wrought Steel with Strengthening on the Back.

Code	Relaxes	Relayant	Relazables	Relazada	Releasable	Release	Relebas
Size, inches.....	3/8	1/2	3/4	1	1 1/4	1 1/2	2
Per 100.....	\$0.55	.65	.80	1.00	1.30	1.60	2.00
Weight per 100, lbs	1 1/2	1 3/4	3	3 3/4	6	7	9 1/2

Loose.

†PLUMBERS' HOOKS—2672-C.

Wrought Steel.

Code.....	Relebit	Relecher	Relecture	Relegabas
Size, inches.....	1/2	3/4	1	1 1/4
Per 100.....	\$1.25	1.50	2.00	2.50
Weight per 100, lbs.....	3	4 1/2	5 3/4	6 1/2

One hundred in a box.

TINNED PIPE STRAPS.

Wrought Steel.

Code.....	Relegandos	Relegare	Relegation	Relegatore	Relegavit	Relegerunt	Relegieren	Relegisset
Size, inches.....	†1/4	†3/8	1/2	3/4	1	1 1/4	1 1/2	2
Per pound.....	\$0.23	.23	.23	.23	.23	.23	.23	.23
Number to 1 lb.....	47	40	24	21	16	15	9

SOIL PIPE HOOKS.



2676-C.

Wrought Steel.

Code.....	Relego	Releguais	Relegue
Size, inches.....	2	3	4
Each.....	\$0.05	.07	.09
Weight per 100, lbs	15 1/2	32	55
Code.....	Releguons	Releixar	
Size, inches.....	5	6	
Each.....	\$0.16	.20	
Weight per 100, lbs.....	91	105	

SOIL PIPE STRAPS.



†2677-C.

Wrought Steel.

Code.....	Relejan	Relejarais	Relejase
Size, inches.....	2	3	4
Each.....	\$0.04	.06	.07
Weight per 100, lbs	30	42 1/2	50
Code.....	Releje	Relentar	
Size, inches.....	5	6	
Each.....	\$0.08	.11	
Weight per 100, lbs.....	60	70	

†Carried in San Francisco only.

In Orders and Specifications give Plate Numbers and Sizes.

GAS FITTERS CEMENT.

HANDY PLUMBERS SOIL.

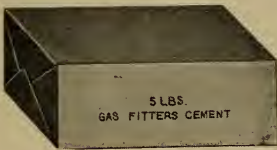

2680-C.

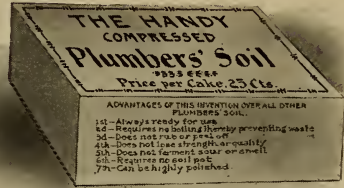

2681-C.

Code..... Relentesco
Per lb..... \$0.20

Five pounds in a package.

Code Relentless
Per dozen cakes..... \$3.00

Weight per dozen, lbs.....

One cake in a box; one dozen boxes in a package.

OAKUM.

COTTON WASTE.

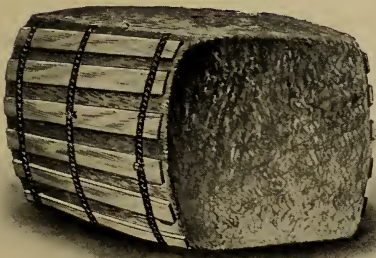

2684-C.



2685-C.

Code..... Relessor Relevabor
Grade..... Plumbers Spun Coiled
Per bale..... \$3.50 4.50

Fifty pounds in a bale.

Coiled Oakum is put up in 5-pound coils 10 coils to the bale.

Code..... Relevages Relevancia
Grade..... No. 1 White Colored
Per lb..... \$0.13 .11

One hundred pounds in a bale.

In Orders and Specifications give Plate Numbers.

SHEET PACKING.

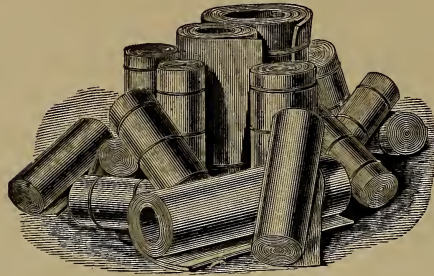

2680-C.

†“ANVIL” SHEET RUBBER PACKING.

Cloth Insertion. 36 Inches Wide.

Code.....	Relevante	Relevemente	Releveris	Releveront	Relevor	Relha
Thickness, inches.....	$\frac{1}{32}$	$\frac{1}{16}$	$\frac{3}{32}$	$\frac{1}{8}$	$\frac{3}{16}$	$\frac{1}{4}$
Per lb	\$0.13½	.13½	.13½	.13½	.13½	.13½
Weight per square yard, lbs	2½	5½	7½	10	15	20

150 to 350 pounds in a roll.

†“ELK” SHEET RUBBER PACKING.

Cloth Insertion. 36 Inches Wide.

Code.....	Relhote	Reliais	Reliance	Reliant	Relicario	Relicemur
Thickness, inches.....	$\frac{1}{32}$	$\frac{1}{16}$	$\frac{3}{32}$	$\frac{1}{8}$	$\frac{3}{16}$	$\frac{1}{4}$
Per lb.....	\$0.20	.20	.20	.20	.20	.20
Weight per square yard, lbs	2½	5½	8	11	17	23

150 to 350 pounds in a roll.

†“RED” SHEET PACKING.

An extra fine quality of Red Sheet Packing, for air, gas, steam, water, ammonia, alkali, etc. Will stand great heat without losing its elasticity. Makes a tight joint and will not crack or harden.

“La Favorite.”

36 Inches Wide.

Code.....	Relicebare	Relicendos	Relichant
Thickness, inches ..	$\frac{1}{16}$	$\frac{3}{32}$	$\frac{1}{8}$
Per lb	\$0.60	.60	.60
Wt. per sq. yd., lbs	6½	10	12½

“Obelisk.”

With Brass Wire Insertion. 36 Inches Wide.

Code.....	Relicheurs	Reliciae	Relicinos
Thickness, inches ..	$\frac{1}{16}$	$\frac{3}{32}$	$\frac{1}{8}$
Per lb	\$0.75	.75	.75
Wt. per sq. yd., lbs	9½	13½	16

†RUBBERBESTOS SHEET PACKING.

Plain Blue Sheet Packing. 36 Inches Wide.

A perfect combination of Asbestos and Rubber, which, after a thorough test in the most severe places, has given satisfactory results. It stands great heat and high pressure.

Can be re-used several times.

Code	Relicy	Relictrix	Relictum	Relied	Relieffer
Thickness, inches	$\frac{1}{16}$	$\frac{3}{32}$	$\frac{1}{8}$	$\frac{3}{16}$	$\frac{1}{4}$
Per lb.....	\$0.72	.72	.72	.72	.72

†Carried in San Francisco only.

In Orders and Specifications give Plate Numbers and Sizes.

SECTION 9.

MISCELLANEOUS SUPPLIES,

SHEET METALS, WIRE,

HOSE, HOSE SUNDRIES,

SOLDER, TOOLS, ETC.



HOLBROOK, MERRILL & STETSON,

INCORPORATED.

SAN FRANCISCO, LOS ANGELES AND NEW YORK.

We aim to carry a complete assortment of the very best quality of tinner's and plumbers' supplies. The following pages show a great many, but, owing to the rapidity with which new and valuable devices and supplies are being put on the market, it is impossible to show all that we carry.

Our Sheet Iron and Tin Plate is the very best that the mills can turn out.

Tools and Machines are of the very highest grade; are made of the best materials, and are as perfect as skilled mechanics can produce them.

In ordering goods by telegraph from this section it is only necessary to use the code word or words over or opposite the name or number of the articles required, preceded by words from the front of this book.

Example: Crogmar acocheis fenargali and abendzug sheets each fetterave and fevelure.

Translation: Ship via quickest route sixty-five pounds number twelve galvanized wire and twenty-five sheets each twenty-two and twenty-eight galvanized iron thirty by ninety-six.

FLAT HEAD STOVE BOLTS.

$\frac{3}{16}$ -INCH DIAMETER.



Code	Febritude	Febrodet	Febrook	Feceden
Length, inch.....	$\frac{1}{2}$	$\frac{5}{8}$	$\frac{3}{4}$	1
Per 100.....	\$0.75	.75	.75	.80
Weight per 100, lbs	.8	.9	1.1	1.3
Code	Fecedrio	Fecelamos	Feccephis	
Length, inches.....	$1\frac{1}{4}$	$1\frac{1}{2}$	2	
Per 100.....	\$0.85	.90	1.00	
Weight per 100, lbs.....	1.4	1.6	2.1	

$\frac{1}{4}$ -INCH DIAMETER.

Code	Fecerchi	Fechaeis	Fechagi	Fechakam	Fechell	Fechepus	Fecherten	Fechoop	Fecreis	Feculmo	Fedagio	Fedalion
Length, in	$\frac{1}{2}$	$\frac{3}{4}$	1	$1\frac{1}{4}$	$1\frac{1}{2}$	$1\frac{3}{4}$	2	$2\frac{1}{2}$	3	$\dagger 3\frac{1}{2}$	$\dagger 4$	$\dagger 4\frac{1}{2}$
Per 100.....	\$0.90	.90	.95	1.00	1.05	1.10	1.15	1.25	1.35	1.45	1.55	1.65
Wt. per 100, lbs	1.9	2.2	2.5	2.9	3.2	3.6	4.	4.7	5.3	6	6.75	7.75

One hundred in a package.

ROUND HEAD STOVE BOLTS.

$\frac{5}{32}$ -INCH DIAMETER.

Code	Fedarade	Fedarfe	Fedaron
Length, inch	$\dagger \frac{1}{2}$	$\dagger \frac{5}{8}$	$\dagger \frac{3}{4}$
Per 100.....	\$0.85	.85	.85

$\frac{3}{16}$ -INCH DIAMETER.

Code.....	Fedarsis	Fedartello	Fedauds	Fedaxas
Length, inch.....	$\frac{1}{2}$	$\dagger \frac{5}{8}$	$\frac{3}{4}$	1
Per 100.....	\$0.85	.85	.85	.90
Weight per 100, lbs	1.	1.1	1.1	1.4



Code.....	Fedegam	Fedentem	Fedentis	Fedenza
Length, inches....	$1\frac{1}{4}$	$1\frac{1}{2}$	$\dagger 1\frac{3}{4}$	$\dagger 2$
Per 100.....	\$0.95	1.00	1.05	1.10
Weight per 100, lbs	1.5	1.8	2.	2.2

$\frac{1}{4}$ -INCH DIAMETER.

Code.....	Federal	Federbast	Federboom
Length, inch.....	$\frac{1}{2}$	$\frac{3}{4}$	1
Per 100.....	\$1.00	1.00	1.05
Weight per 100, lbs.....	2.3	2.6	3.

Code.....	Federbosch	Federhars	Federhout
Length, inches.....	$1\frac{1}{4}$	$1\frac{1}{2}$	$\dagger 2$
Per 100.....	\$1.10	1.15	1.25
Weight per 100, lbs.....	3.4	3.6	4.2

One hundred in a package.

TINNED BURRS.

MADE FROM SWEDES IRON.

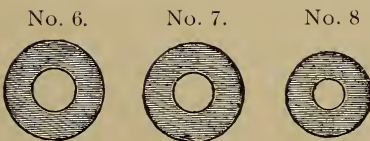

Cuts show full size.

Code.....	Federian	Federito	Federolie
Numbers.....	6	7	8
Number to a pound	330	368	398
Per pound	\$0.43	.44	.45

One pound in a package. Number denotes size of wire.

\dagger Carried in San Francisco only.

TINNERS' RIVETS.

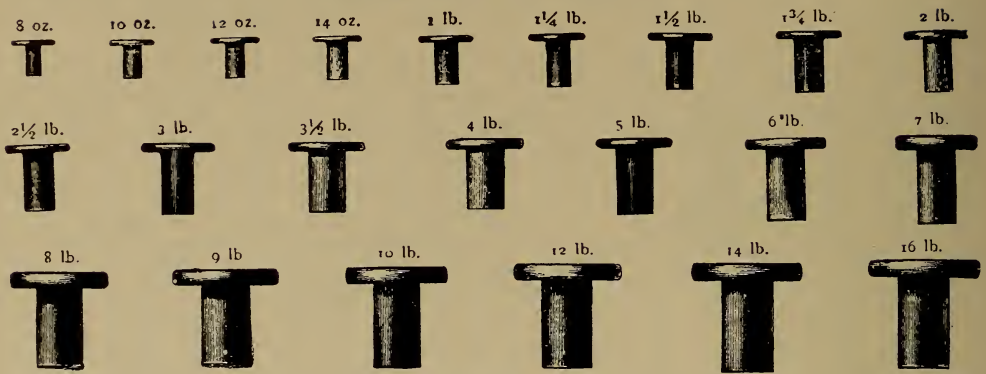

Cuts show full size.

Black Iron, in Packages.

Code.....	Federont	Fediamo	Fedimento						
Size, ounces.....	8	10	12						
Per 1000.....	\$0.20	.22	.24						
Case lots, 1000.....						
Code.....	Fedonem	Fedoniate	Fedopolis	Fedorum	Fedotano	Fedraaf			
Size, pounds.....	1	†1 1/4	1 1/2	†1 3/4	2	†2 1/2			
Per 1000.....	\$0.27	.29	.33	.37	.42	.55			
Case lots, 1000.....	96	70			
Code.....	Fedraden	Fedremo	Fedrezes	Fedriamo	Fedricaret	Fedriya	Fedronde	Fedroost	Fedrotael
Size, pounds.....	†3	†4	†5	†6	†7	†8	†10	†12	†14
Per 1000.....	\$0.60	.76	.90	1.08	1.26	1.44	1.75	1.96	2.31
Case lots, 1000.....	60	48	37	30	25	24	20	16

One thousand in a package. Approximate weight of cases two hundred pounds.

† **Black Iron, in Bulk.**

Code.....	Fedruck	Fedrufen	Fedrufo	Fedunst	Feduntur	Fedutsen	Feedait	Feedake
Size, pounds.....	3	4	5	6	7	8	10	12
Per pound.....	\$0.19	.18	.18	.17	.17	.17	.16	.15 1/2

One hundred pounds in a keg.

Tinned Norway Iron, in Packages.

Code.....	Feedalas	Feedames	Feedasse	Feedatha	Feedava					
Size, ounces.....	†4	†6	†8	†10	†12					
Per 1000.....	\$0.28	.28	.28	.31	.35					
Code.....	Feedeas	Feedelfo	Feedendi	Feedero	Feedevin					
Size, pounds.....	†1	†1 1/4	†1 1/2	†1 3/4	†2					
Per 1000.....	\$0.42	.48	.55	.64	.72					
Code.....	Feediato	Feediger	Feedinas	Feedoen	Feedom	Feedoner	Feedonot	Feedotier	Feedrift	Feedrigo
Size, pounds...	†2 1/2	†3	†3 1/2	†4	†5	†6	7	8	10	†12
Per 1000.....	\$0.83	1.05	1.22	1.36	1.65	1.98	2.31	2.64	3.25	3.76

Tin Plated Soft Steel, in Packages.

Code.....	Feedrina	Feedroth	Feedruf								
Size, ounces.....	8	10	12								
Per 1000.....	\$0.24	.27	.30								
Code.....	Feedrupt	Feeduto	Feegement	Feegewa	Feegevalt	Feeglipt	Feegluth	Feegold	Feegory	Feegostar	Feegovant
Size, pounds	1	1 1/4	1 1/2	1 3/4	2	2 1/2	3	3 1/2	4	5	6
Per 1000.....	\$0.35	.39	.45	.51	.58	.75	.84	.98	1.08	1.30	1.56

Case lots same as black.

† Carried in San Francisco only.

† **TINNERS' RIVETS.**

Copper, in Packages.

Code.....	Feegreer		
Size, ounces		12	
Per 1000.....			\$0.50
Code.....	Feekern	Feekidas	Feekleur
Size, pounds.....	1	1½	2
Per 1000.....	\$0.60	.75	.80

One thousand in a package. Case lots same as black.

Approximate Dimensions of Tinners' Rivets:

English Standard Gauge.

Size.	Length.	Diameter Wire Gauge.	Size.	Length.	Diameter Wire Gauge.	Size.	Length.	Diameter Wire Gauge.
8 ounce.....	$\frac{5}{32}$	No. 13¼	2 pound ...	$\frac{17}{64}$	No. 9¼	7 pound ...	$\frac{13}{32}$	No. 5¼
10 "	$\frac{11}{64}$	" 13	2½ "	$\frac{9}{32}$	" 9	8 "	$\frac{7}{16}$	" 4¾
12 "	$\frac{3}{16}$	" 12¼	3 "	$\frac{5}{16}$	" 8¼	9 "	$\frac{29}{64}$	" 4¼
14 "	$\frac{3}{16}$	" 12	3½ "	$\frac{21}{64}$	" 8	10 "	$\frac{15}{32}$	" 4
1 pound ..	$\frac{13}{64}$	" 11¾	4 "	$\frac{11}{32}$	" 7¼	12 "	$\frac{12}{32}$	" 3
1¼ " ..	$\frac{7}{32}$	" 11	5 "	$\frac{3}{8}$	" 6¾	14 "	$\frac{33}{64}$	" 2
1½ " ..	$\frac{15}{64}$	" 10¼	6 "	$\frac{25}{64}$	" 6	16 "	$\frac{17}{32}$	" 1
1¾ " ..	$\frac{1}{4}$	" 10						

† **OVAL HEAD IRON RIVETS.**

BLACK.



Code.....	Feeknot	Feelavius	Feelebit	Feelectos
Size, lbs.....	2	2½	3	4
English Standard Gauge.....	11	10	9	6
Length, inch.....	½	½	½	½
Per 1000	\$0.62	.75	.80	.96

One thousand in a package.

† **OVAL HEAD IRON RIVETS.**

BLACK.



OVAL HEAD

Code	Feeleput	Feelerus	Feeliano
Wire gauge	7	6	6
Length, inches	$\frac{3}{4}$	1	1¼
Per pound	\$0.21½	.21	.21
Rivets in a pound.....	129	82	69
Code	Feelitif	Feelogo	Feelordo
Wire gauge	6	6	8
Length, inches	1½	1¾	1¼
Per pound21	.21	.22
Rivets in a pound.....	59	55	109

One pound in a package.

† Carried in San Francisco only.

† **OVAL HEAD RIVETS.**

BRASS.

For Spice Can Tops.

Code.....	Feemaker
Wire gauge.....	14
Length, inch.....	$\frac{1}{8}$
Per pound.....	\$1.00

† **STOVE PIPE ELBOW RIVETS.**

BLACK. FLAT HEAD.

Code.....	Feemalis
Wire gauge.....	14
Length, inch.....	$\frac{1}{16}$
Per pound.....	\$0.66

† **BRAZIERS' COPPER RIVETS.**

No. 1.



No. 2.



No. 3.



Cuts show full size.

Code.....	Feemarch	Feemians	Feemical	Feemicos	Feemists	Feemiter	Feemogen	Feemos	Feenacis	Feenare
Numbers.....	0	1	2	3	4	5	6	7	8	9
Number to pound.....	148	100	70	44	34	24	18	12	9	6
Diameter, inch.....	$\frac{3}{16}$	$\frac{1}{4}$	$\frac{17}{64}$	$\frac{9}{32}$	$\frac{5}{16}$	$\frac{23}{64}$	$\frac{3}{8}$	$\frac{7}{16}$	$\frac{1}{2}$	$\frac{19}{32}$
Length, inch.....	$\frac{3}{8}$	$\frac{1}{2}$	$\frac{1}{2}$	$\frac{5}{8}$	$\frac{11}{16}$	$\frac{3}{4}$	$\frac{13}{16}$	$\frac{15}{16}$	$1\frac{1}{8}$	$1\frac{1}{4}$
		Per pound, \$0.66.								

† **FEEDER CAPS AND COLLARS.**

BRASS.

Code.....	Feeneraba
Number.....	4
Bottom diameter of collar, inches.....	$1\frac{1}{16}$
Per gross.....	\$7.00
Weight per gross, lbs.....	$2\frac{1}{4}$

One gross in a box.



† **OILER SCREWS AND HOOPS.**

BRASS.

Code.....	Feenest	Feenique	Feenitine
Numbers.....	1	2	3
Diameter, inch.....	$\frac{3}{8}$	$\frac{1}{2}$	$\frac{5}{8}$
Per gross.....	\$9.00	10.00	12.00
Weight per gross, lbs.....	$\frac{3}{4}$	$\frac{3}{4}$	$\frac{7}{8}$

Five hundred in a box.

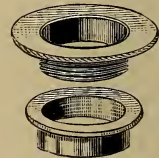

† **SOLID LAMP HOOPS.**

BRASS.

Code.....	Feenium	Feetalha
Numbers.....	1	3
Thread diameter, inch.....	$\frac{7}{8}$	$\frac{3}{4}$
Per gross.....	\$4.00	4.00

Five hundred in a box.



† Carried in San Francisco only.

PERFORATED TIN.

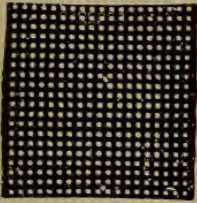

No. 0.

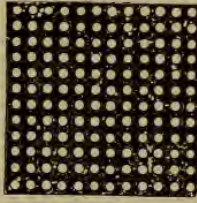

No. 3.

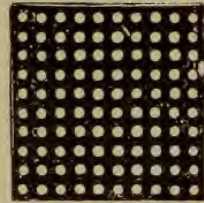

No. 4

EXTRA CHARCOAL.

Code.	Numbers.	Thickness.	Size Sheet, Inches.	Sheets in Box.	Weight per Box.	Per Dozen Sheets
Felmutes	0	IC	10 x 14	225	87 lbs.	\$3.50
Felonite	1	IC	10 x 14	225	76 "	3.00
Felpan	2	IC	10 x 14	225	71 "	2.50
Felschoxan	† 1	IXX	10 x 14	225	3.50
Felschozde.....	† 2	IXX	10 x 14	225	3.50
Felschot	3	IXXXX	10 x 14	225	118 "	3.50
Felschude.....	† 0	IC	14 x 20	112	88 "	6.00
Felschuff.....	† 1	IC	14 x 20	112	82 "	6.00
Felschum.....	† 3	IC	14 x 20	112	6.00
Felschur	† 1	IXX	14 x 20	112	125 "	6.00
Felsogno.....	† 2	IXX	14 x 20	112	121 "	6.00
Felspiel	† 3	IXX	14 x 20	112	115 "	6.00
Felstar	† 4	IXX	14 x 20	112	100 "	6.00
Felwasser	5	IXX	14 x 20	112	97 "	6.00
Felwerk	6	IXX	14 x 20	112	79 "	6.00
Felwitz	† 3	IXXXX	14 x 20	112	118 "	7.00
Felzaron.....	† 4	IXXXX	14 x 20	112	103 "	7.00
Felzeil	† 5	IXXXX	14 x 20	112	100 "	7.00
Felziona	† 6	IXXXX	14 x 20	112	82 "	7.00

COKE.

Code.	Numbers.	Thickness.	Size Sheet, Inches.	Sheets in Box.	Weight per Box.	Per Dozen Sheets.
Femacan	† 3	IC	10 x 14	225	71 lbs.	\$2.50
Femacris	† 4	IC	10 x 14	225	69 "	2.50
Femalden	† 5	IC	10 x 14	225	63 "	2.50
Femaloid	† 0	IC	14 x 20	112	87 "	7.00
Femalung	† 1	IC	14 x 20	112	85 "	5.00
Femanzar	† 2	IC	14 x 20	112	72 "	5.00
Femaorum.....	† 3	IC	14 x 20	112	71 "	5.00
Femaquer	† 4	IC	14 x 20	112	71 "	5.00

Table showing sizes of perforations in inches, number of perforations to the lineal inch, wire gauge of holes, and comparison numbers of slotted screens, meshes of wire screens and needle punch.

Numbers.	Style.	Diameter of Holes, Inches.	Holes to Lineal Inch.	Wire Gauge of Holes.	Comparison No. Slotted Screens.	Comparison Mesh Wire Screens.	Comparison No. Needle Punch.
0	Extra Fine...	.027	20	22 B. & S.	No. 9	45	7
1	Fine033	18	19 "	" 7	35	5
2	Medium.....	.042	15	17 "	" 5	25	3
3	Coarse.....	.050	12	16 "	" 3	15	1
4	"066	10	14 "	00
5	"072	7½	13 "
6	Extra Coarse	.106	7½	10 "

†Carried in San Francisco only.

† OIL AND LIQUOR PUMP VALVES AND PLUNGERS.

WITH LEATHER PACKING.

Code	Femarrola
Inches.....	1¼
Per dozen sets.....	\$6.00
Weight per dozen sets.....	1¾
One dozen sets in a box.	

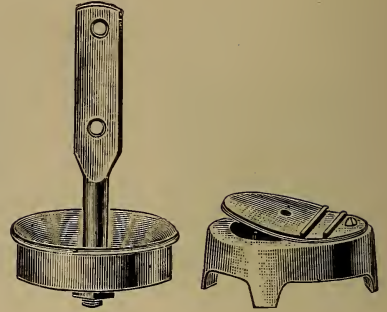

STEEL WIRE.

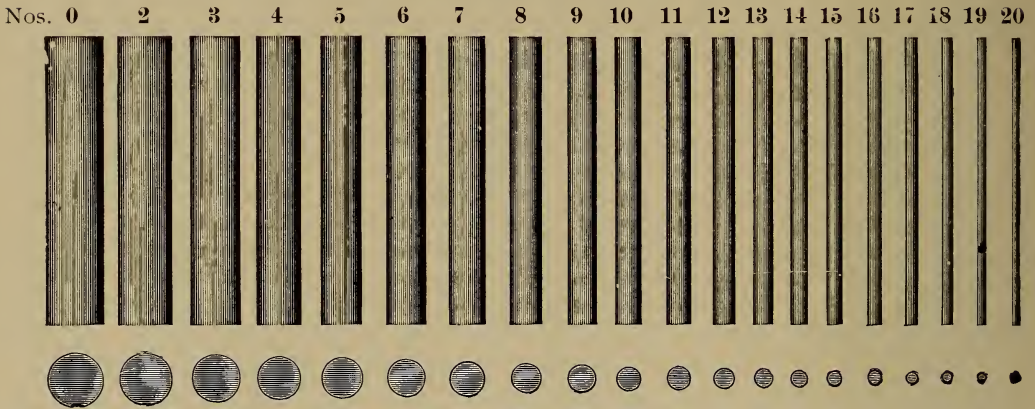

ANNEALED MARKET WIRE.

100-Pound Bundles.

Code.....	Femarsine	Femarus	Femascato	Femdanza	Femegass	Femegava
Numbers.....	7	8	9	10	11	12
Per pound	\$0.10	.10	.10	.11	.11	.11½
Code.....	Femelar	Femelete	Femelicas	Femescam	Femicetta	Femigella
Numbers.....	13	14	15	16	17	18
Per pound12½	.12½	.14	.14	.15	.16

Numbers 13, 14, 15 and 16 are used for Baling Wire.

BRIGHT MARKET WIRE.

63-Pound Bundles.

Code	Femikoos	Femillos	Femitant	Femizen	Femodonal	Femogato	Femoidal	Femonite	Femoribus	Fembacht
Numbers	0	1	2	3	4	5	6	7	8	9
Per pound.....	\$0.10	.10	.10	.10	.10	.10	.10	.10	.10	.10
Code.....	Fempapst	Fempelle	Femperst	Fempiendo	Femsech	Femsico	Femsilio	Fenacione	Fenaidum	
Numbers	10	11	12	13	14	15	16	17	18	
Per pound	\$0.11	.11	.11½	.12½	.12½	.14	.14	.15	.16	

CALVANIZED MARKET WIRE.

100-Pound Bundles.

Code	Fenaldoli	Fenalisalz	Fenaltic	Fenamilla	Fenance	Fenanken	Fenannas	Fenantem	
Numbers	2	3	4	5	6	7	8	9	
Per pound	\$0.10	.10	.10	.10	.10	.10	.10	.10	
Code	Fenanthen	Fenappen	Fenargali	Fenascius	Fenatica	Fenazite	Fencable	Fencants	
Numbers.....	10	11	12	13	14	15	16	18	
Per pound	\$0.11	.11	.11½	.12½	.12½	.14	.14	.16	

†Carried in San Francisco only.

COPPERED MARKET WIRE.

63-Pound Bundles.

Code.....	Fencay	Fenchada	Fenchean	Fenchone	Fenciado	Fendemia	Fendieron	Fendritt	Fendrosi
Numbers	1	2	3	4	5	6	7	8	9
Per pound	\$0.10	.10	.10	.10	.10	.10	.10	.10	.10
Code.....	Fenelines	Fenepoti	Fenerabil	Fenevolus	Fengoar	Fengott	Fengulado	Fenhafiz	Fenhassar
Numbers	10	11	12	13	14	15	16	17	18
Per pound	\$0.11	.11	.11½	.12½	.12½	.14	.14	.15	.16

TINNED WIRE.

63-Pound Bundles.

Code	Fenhegan	Fenhiras	Fenhonso	Fenicale	Fenicots	Feniscope	Fenmahl	Fenmule
Numbers.....	6	7	8	9	10	12	14	16
Per pound	\$0.15	.15	.15	.15	.16	.17	.17	.17½

ANNEALED STONE WIRE.

12-Pound Bundles.

Code.....	Fennebit	Fennetti	Fennetur	Fennibus	Fennita	Fennista	Fennosco	Fenodator	Fenolied
Numbers	16	17	18	19	20	21	22	23	24
Per pound	\$0.14	.15	.16	.19	.20	.21	.22	.23	.24

GALVANIZED STONE WIRE.

12-Pound Bundles.

Code.....	Fenopfer	Fentarum	Fentebam
Numbers.....	16	18	20
Per pound	\$0.14	.16	.20

TINNED STONE WIRE.

12-Pound Bundles.

Code	Fentella	Fentesma	Fenzak
Numbers.....	18	19	20
Per pound	\$0.18½	.19	.19

Steel wire numbered according to American Steel Wire Company's gauge.

Table of Size, Weight, Length and Strength of Iron Wire.

Wire Gauge. Number.	Diameter, Inches.	Pounds Per 100 Feet.	Pounds Per Mile.	Feet in 63 Pounds.	Feet in 100 Pounds.	Breaking Weight, Pounds.
0	.307	24.97	1,318.41	228	399	5,926
1	.283	21.23	1,120.94	296	468	5,226
2	.263	18.34	968.35	343	544	4,570
3	.244	15.78	733.18	399	631	3,948
4	.225	13.42	708.57	470	738	3,374
5	.207	11.35	559.28	555	875	2,839
6	.192	9.77	515.85	647	1,017	2,476
7	.177	8.30	438.24	759	1,197	2,136
8	.162	6.96	367.48	905	1,429	1,813
9	.148	5.80	306.24	1,086	1,705	1,507
10	.135	4.83	255.02	1,304	2,057	1,233
11	.120	3.82	201.69	1,649	2,582	1,010
12	.105	2.92	154.17	2,158	3,369	810
13	.092	2.24	118.27	2,813	4,478	631
14	.080	1.69	89.23	3,728	5,858	474
15	.072	1.37	72.33	4,598	7,232	372
16	.063	1.05	55.44	6,000	9,598	292
17	.054	.77	40.76	8,182	12,860	222
18	.047	.58	30.89	10,862	16,620	169
19	.041	.45	23.49	14,000	22,300	124
20	.035	.32	17.10	19,687	30,960	96
21	.032	.27	14.30	23,333	37,310	72
22	.028	.21	10.92	30,000	45,840	54
23	.025	.17	8.71	56,330
24	.023	.14	7.39	70,870

SOFT COPPER WIRE.

Code	Fenzalimp	Fenzamuk	Fenzarico	Fenziale																
Numbers.....	3	4	5	6																
Per pound.....	\$0.28	.28	.28	.28																
Code	Fenziren	Feobacco	Feodasti	Feoditer																
Numbers.....	7	8	9	10																
Per pound.....	\$0.28	.28	.28	.28																
Code	Feodora	Feofassi	Feofates	Feokasse	Feolaag	Feolanti	Feolaque	Feolard	Feolaria	Feolassi	Feolingo									
Numbers.....	11	12	13	14	15	16	17	18	19	20	22									
Per pound	\$0.28 1/2	.28 1/2	.28 1/2	.28 1/2	.29	.30	.32	.32	.33	.33	.35									



Nos. 5 to 13 put up in 25-pound coils. Nos. 14 to 32 put up in 5-pound coils.

HIGH BRASS WIRE.

5-Pound Coils.

Code	Feolistic	Feolippe	Feolood	Feomeator	Feomeister	Feopases	Feopimus	Feopitum												
Numbers	4	5	6	7	8	9	10	11												
Per pound.....	\$0.23	.23	.23	.23	.23	.23	.23	.23 1/2												
Code					Feosisto	Feositis	Feotado	Feotandi	Feoten											
Numbers					12	13	14	15	16											
Per pound.....					\$0.23 1/2	.23 1/2	.23 1/2	.23 1/2	.23 1/2											

SPRING BRASS WIRE.

5-pound Coils.

Code.....	Fepaturu	Fepcalib	Fepolini	Feracari	Ferachico	Feraline	Ferbarca	Ferbaren	Ferbatage											
Numbers	3	4	5	6	7	8	9	10	11											
Per pound	\$0.25	.25	.25	.25	.25	.25	.25	.25	.25 1/2											
Code.....										Ferbelebt	Ferbillas	Ferblant								
Numbers										13	15	16								
Per pound										\$0.25 1/2	.25 1/2	.25 1/2								

Brass and copper wire numbered according to Brown and Sharpe's gauge.

†SEAMLESS BRASS TUBING.



FOR PUMP CYLINDERS, ETC.

Code	Ferbogia	Ferbooni	Fercassi	Ferchen	Ferchung	Ferdance	Ferdiste	Ferdite	
Inside diameter, inches	3	3	3	3	4	4	4	4	
Stub's gauge, numbers.....	14	16	18	20	14	16	18	20	
Weight per foot, lbs	2.80	2.20	1.67	1.20	3.76	2.96	2.24	1.60	
Per pound	\$.....	

In lengths of 12 and 18 feet.

Cut any desired length to order. Add for cutting lengths per pound, \$.05.

†Carried in San Francisco only.

SEAMLESS BRASS TUBING.

BRASS AND NICKEL-PLATED.

Code.....	Ferdiva	Ferdouant	Ferdules	Ferdumas	Ferdump	Ferdunil
Outside diameter, inches.....	$\frac{3}{4}$	1	†1$\frac{1}{8}$	†1$\frac{3}{8}$	†1$\frac{3}{4}$	†2
Stub's gauge, numbers.....	25	24 $\frac{1}{2}$	22
Weight per foot, lbs.....	.17	.24	.40
Covers Standard Iron Pipe, inch.....	$\frac{3}{8}$	$\frac{1}{2}$	$\frac{3}{4}$	1	1 $\frac{1}{4}$	1 $\frac{1}{2}$
Per foot.....	\$.....

In lengths of 6 feet.

†BRAZED BRASS TUBING.

Code.....	Ferepuno	Ferfando	Ferfetar	Fergaben
Outside diameter, inches.....	1$\frac{1}{4}$	1$\frac{3}{8}$	1$\frac{1}{2}$	1$\frac{1}{2}$
B. & S. gauge, numbers.....	22	22	22	20
Weight per foot, lbs.....	.36	.395	.43	.54
Per foot.....	\$.....

In lengths of 6 feet.

Add for nickel-plating.

BRAZED BRASS TUBING.

NICKEL-PLATED. ANNEALED. FOR BASIN SUPPLIES.

Code.....	Fergadil
Outside diameter, inch.....	$\frac{1}{2}$
B. & S. gauge, number.....	20
Weight per foot, lbs.....	.19
Per foot.....	\$.....

In lengths of 6 feet.

† SEAMLESS BRASS PIPE.

STANDARD IRON PIPE SIZE. NOT THREADED. LIGHT ANNEALED FOR BENDING.

Code.....	Fergafuey	Fergagin
Inch.....	$\frac{3}{8}$	$\frac{1}{2}$
Weight per foot, lbs.....	.62	.90
Outside diameter, inch.....	.675	.840
Per foot.....	\$.....

In lengths of 6 feet.

Add for cutting and threading. Add for nickel-plating.

SEAMLESS BRASS PIPE.

STANDARD IRON PIPE SIZE. NOT THREADED. SMOOTH AND BRIGHT.

Code.....	Fergalacte	Fergapt	Fergapen	Fergeln	Fergessi	Fergich	Fergimus
Inches.....	$\frac{3}{8}$	$\frac{1}{2}$	$\frac{3}{4}$	†1	†1$\frac{1}{4}$	†1$\frac{1}{2}$	†2
Weight per foot, lbs.....	.62	.90	1.25	1.70	2.50	3.00	4.00
Outside diameter, inches.....	.675	.840	1.05	1.315	1.66	1.90	2.375
Inside " ".....	1 $\frac{5}{32}$	$\frac{5}{8}$	2 $\frac{7}{32}$	1 $\frac{3}{32}$	1 $\frac{1}{32}$	1 $\frac{19}{32}$	2 $\frac{1}{6}$
Per pound.....	\$.....

In lengths of 12 feet. Cut any desired length to order.

Add for cutting and threading. Add for polishing and nickel-plating.

† Carried in San Francisco only.

† **HIGH BRASS IN ROLLS.**

SUITABLE FOR SPINNING AND GENERAL USE.

14 Inches Wide.

Code.....	Fergitur	Ferglanz	Fergresse	Fergrond
Numbers	12	14	16	18
Per pound	\$.....



Code	Fergunst	Ferguss	Ferhapt	Ferhande	Ferkappe	Ferklopt	Ferlagen
Numbers	20	22	24	26	28	30	32
Per pound.....	\$.....

18 Inches Wide.

Code	Fermate	Fermerai	Ferrest	Fermique	Fermita	Fermitigo	Fermond	Fermust	Fernadet	Fernardo
Numbers	14	16	18	20	22	24	26	28	30	32
Per pound	\$.....

Full rolls, 50 to 70 pounds.

SIGN BRASS.

‡ NO. 16 BROWN AND SHARPE'S GAUGE.

Code	Fernasupp	Fernatic	Ferneding	Fernefant
Width, inches.....	12	18	24	30
Per pound.....	\$.....

† NO. 14 BROWN AND SHARPE'S GAUGE.

Code	Fernesco	Ferogava	Feromeiza	Feronder	Ferontine	Feroque
Width, inches.....	9	12	14	18	24	30
Per pound	\$.....

Sheets 12 to 14 feet in length. We do not cut sign brass.

† **HIGH BRASS IN SHEETS.**

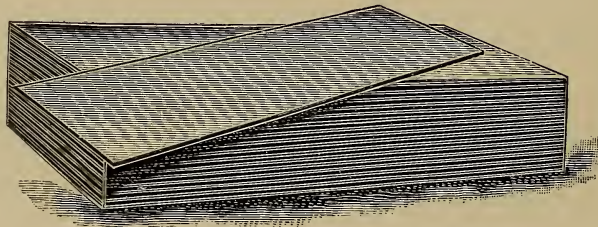

HALF HARD.

24 x 48 inches.

Code	Feroth	Ferpado	Ferpend	Ferpezzi	Ferpiter	Ferrador	Ferrano	Ferrebbe	Ferresti
Wt. per sheet, lbs.....	5	6	7	8	10	12	15	18	20
B. & S. Gauge, Nos.....	27	25	24	23	21	20	18	16	15
Per pound	\$.....

Roll and Sheet Brass numbered according to Brown and Sharpe's gauge.

‡ Carried in Los Angeles only. † Carried in San Francisco only.

BRAZIERS' SHEET COPPER.

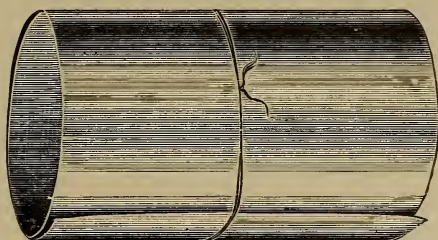

SOFT ROLLED.

30 x 60 Inches.

Code	Fersant	Fersebit	Fersemus	Fersida	Fersjuck
Weight per sheet, lbs.....	†7¾ to 9	9¼ to 10	11 to 12	12½	14
Stubs' gauge, numbers.....	29	27	26	24	23
Weight per square foot, ounces.....	10	12	14	16	18
Per pound.....	\$.....

† We also carry 30 x 60 sheets weighing 15, 16, 17, 18, 19, 20, 21, 22, 25, 28, 30, 35, 40 pounds each.

GENUINE PLANISHED SHEET COPPER.

COLD ROLLED. TINNED ON ONE SIDE.

† 14 x 18 Inches.

Code	Personne	Fersorum	Ferstal
Weight per square foot, ounces.....	12	14	16
Stubs' gauge, numbers.....	27	26	24
Per pound.....	\$.....
Tinning per sheet.....	\$.....

14 x 56 Inches.

Code	Ferstampt	Ferstate	Fertech
Weight per square foot, ounces.....	†12	14	16
Stubs' gauge, numbers.....	27	26	24
Per pound.....	\$.....
Tinning per sheet.....	\$.....

† 14 x 60 Inches.

Code	Fertical	Fertiga
Weight per square foot, ounces.....	14	16
Stubs' gauge, numbers.....	26	24
Per pound.....	\$.....
Tinning per sheet.....	\$.....

Sheet copper numbered according to Stubs' gauge.

GENUINE PLANISHED SHEET COPPER.

COLD ROLLED. TINNED ON ONE SIDE.

30 x 60 Inches.

Code	Fertorial	Fertrine	Ferviavor	Fesadore	Fesakengi	Fesaphora	Fescamus	Fescando	Fescate	Fesegeur
Weight per sheet, lbs....	10	11	† 12	13	† 14	† 15	† 16	† 18	† 20	† 22
Stubs' gauge, numbers ...	27	26	25	24	23	22	22½	21	21½	20
Wt. per square foot, ozs..	12	14	15	16	18	20	22	24	25	28
Per pound.....	\$.....
Tinning per sheet... \$.....

‡ Carried in Los Angeles only.

† Carried in San Francisco only.

TINNED SHEET COPPER.

SOFT ROLLED. TINNED ON ONE SIDE.

† 14 x 48 inches.

Code.....	Feshadi	Feshayot	Fesicles	Fesidness	Fesificos
Weight per square foot, ounces.....	12	14	16	18	20
Stubs' gauge, numbers.....	27	26	24	23	22
Per pound.....	\$.....
Tinning per sheet.....	\$.....

30 x 60 inches.

Code.....	Fesivago	Feskje	Feskluit	Feskung	Feslomand
Weight per sheet, lbs.....	†8 to 9	9¼ to 10¾	11 to 12	12½	13 to 14
Weight per square foot, ounces.....	11	12	14	16	18
Per pound.....	\$.....
Tinning per sheet.....	\$.....

† We also carry 30 x 60-inch sheets weighing 15, 16, 18 and 20 pounds each.

CORNICE COPPER.

COLD ROLLED. PATENT LEVELED.

† 24 x 96 inches.

† 30 x 60 inches.

Code.....	Fesocomo	Fesolus	Fessadera	Fessagom	Fessehide	Fessione	Fesslag	Fesslent
Weight per square foot, ounces	12	14	16	18	10	16	18	† 22
Stubs' gauge, numbers.....	27	26	24	23	29	24	23	21½
Per pound.....	\$.....

30 x 72 inches.

30 x 96 inches.

Code.....	Fessmuge	Fesstiva	Fesstola	Fesstube	Festabi	Festamin	Festapso	Festardo
Weight per square foot, ounces	12	14	† 16	18	† 12	14	† 16	† 18
Stubs' gauge, numbers.....	27	26	24	23	27	26	24	23
Per pound.....	\$.....

Sheet Copper numbered according to Stubs' gauge.

† Carried in San Francisco only.

† **TOBIN BRONZE RODS.**

REGULAR ROUND BARS. SUITABLE FOR PUMP RODS, STAY RODS, BOLTS, ETC. HARD, DUCTILE, NON-CORROSIVE, STRONG, TOUGH AND UNIFORM.

Code.....	Festarell	Festarent	Festareux	Festaseck	Festasist	Festaurus	Festavid	Festawat	Festaxem
Diameter, inches.....	1/8	3/16	1/4	3/8	1/2	5/8	3/4	13/16	7/8
Weight, per foot, lbs..177	.399	.711	1.11	1.60	2.18
Per pound.....	\$

Code.....	Festbard	Festbeere	Festbird	Festboom	Festbowl	Festbrand	Festbreech	Festbride
Diameter, inches.....	1	1 1/8	1 1/4	1 3/8	1 7/16	1 1/2	1 3/4	2
Weight, per foot, lbs.....	2.84	3.60	4.46	5.36	6.42	8.70	11.38
Per pound.....	\$.....

Length of bars 15 to 17 feet.

We can supply any of the above sizes from stock.

WE ARE PACIFIC COAST AGENTS FOR TOBIN BRONZE

Which we can furnish from factory in the following forms: Pump Piston Rods, Flat, Round, Square and Hexagon Bars, Plates, Sheets and Billets.

Tobin Bronze is a combination of copper with other metals. Can be forged either hot or cold. Has a specific gravity of 8.379 as against 8.93 for copper. The weight of a **cubic inch** of Tobin Bronze and Copper is respectively .3021 and .3176 of a pound, a difference of .0155 of a pound in favor of Tobin Bronze.

It is suitable for:

- Pump Piston Rods and Valve Stems, Railway Car Boxes,
- Pump Plungers, Valve Faces, Block Pins, Center Boards,
- Gun Carriage Tracks and Slides, Condenser Tubes Plates and Stay Rods,
- Forged Gunpowder Tools, Launch Shafting,
- Cross-head Gibs and Slides, Tannic Acid Extractor Shells,
- Disc Valves for Pumps, Hull Plates for Yachts. etc.
- Powder Mill Plates, Commutator Bars and Drop
- Propeller Bolts, Forgings of Every Description,
- Deck Bolts and Ship Fastenings, Bolts, Nuts, Screws and Rivets,
- Linings for Pumps, Fin Keels and Rudders,
- Turnbuckles and Liners, Perforated Screen Plates for Coal Mines and Paper Mills.

Testimonials from some of the largest manufacturers in the United States give Tobin Bronze the highest recommendations, and when once used by a manufacturer has taken the place of all other metals for high grade work.

INSTRUCTIONS FOR ORDERING AND USING TOBIN BRONZE.

In ordering sheets, rods, etc., of Tobin Bronze, **please mention for what purpose the metal is to be used, temper required, and the strain subjected to when in practical use.** This information is necessary for guidance in the manufacture and treatment of the metal.

In forging, flanging and upsetting Tobin Bronze, great care should be taken to heat it gradually and work it only at a **cherry red heat**. It is particularly specified not to work or strike the metal at a black heat. Always allow forgings to cool gradually.

To forge a bolt head or flange a plate, sufficient of the metal should be heated to insure soundness and uniformity after finishing.

When required for **Piston Rods** or yacht shafting so specify, as we supply them finished and perfectly straight cut to required lengths.

Particulars and prices of plates, rods, etc., furnished on application.

† Carried in San Francisco only.

Weight of Copper and Brass Wire and Plates by American Gauge.

Number of Gauge.	Thickness, Decimals of Inch.	Weight of Wire per 1000 Lineal Feet.		Weight of Plates per Square Foot.	
		Copper, lbs.	Brass, lbs.	Copper, lbs.	Brass, lbs.
0	.32486	319.45	301.82	14.716	13.904
1	.28930	253.34	239.35	13.105	12.382
2	.25763	200.91	189.82	11.671	11.027
3	.22942	159.32	150.52	10.393	9.8192
4	.20431	126.35	119.38	9.2552	8.7445
5	.18194	100.20	94.666	8.2419	7.787
6	.16202	79.462	75.075	7.3395	6.9345
7	.14428	63.013	59.545	6.5359	6.1752
8	.12849	49.976	47.219	5.8206	5.4994
9	.11443	39.636	37.437	5.1837	4.8976
10	.10189	31.426	29.687	4.6156	4.3609
11	.090742	24.924	23.549	4.1106	3.8838
12	.080808	19.766	18.676	3.6606	3.4586
13	.071961	15.674	14.809	3.2598	3.0799
14	.064084	12.435	11.746	2.9030	2.7428
15	.057068	9.859	9.315	2.5852	2.4425
16	.050820	7.819	7.587	2.3021	2.1751
17	.045257	6.199	5.857	2.0501	1.937
18	.040303	4.916	4.645	1.8257	1.725
19	.035890	3.899	3.684	1.6258	1.5361
20	.031961	3.094	2.920	1.4478	1.3679
21	.028462	2.452	2.317	1.2893	1.2182
22	.025347	1.945	1.838	1.1482	1.0849
23	.022571	1.542	1.457	1.0225	.96604
24	.020100	1.223	1.155	.91033	.86028
25	.017900	.9699	.9163	.81087	.76612
26	.01594	.7692	.7267	.72208	.68223
27	.014195	.6099	.5763	.64303	.60755
28	.012641	.4837	.4570	.57264	.54103
29	.011257	.3835	.3624	.50994	.48180
30	.010025	.3002	.2874	.45413	.42907
31	.008928	.2413	.2280	.40444	.38212
32	.007950	.1913	.1808	.36014	.34026

Official Table Adopted by the Association of Copper Manufacturers of the United States.

Rolled copper has specific gravity of 8.93. One cubic foot weighs $558^{1\frac{25}{100}}$ lbs. One square foot one inch thick weighs $46^{5\frac{1}{100}}$ lbs.

Ounces per Square Foot.	14x48 Sheets. Weight in pounds.	30x60 Sheets. Weight in pounds.	48x72 Sheets. Weight in pounds.	Thickness in Decimal Parts of One Inch.	Stubs' Gauge, Nearest Number.
4	1.16	3.12	6	.00537	35
6	1.75	4.68	9	.00806	33
8	2.33	6.25	12	.0107	31
10	2.91	7.81	15	.0134	29
12	3.50	9.37	18	.0161	27
14	4.08	10.93	21	.0188	26
16	4.66	12.50	24	.0215	24
18	5.25	14.06	27	.0242	23
20	5.83	15.62	30	.0269	22
24	7.	18.75	36	.0322	21
32	9.33	25.	48	.0430	19
40	11.66	31.25	60	.0538	18
48	14.	37.50	72	.0645	16
56	16.33	43.75	84	.0754	15
64	18.66	50.	96	.0860	14
70	55.	105	.095	13
81	63.	122	.109	12
89	70.	134	.120	11
100	78.	150	.134	10
110	86.	165	.148	9
123	96.	184	.165	8
134	105.	201	.180	7
151	118.	227	.203	6

Table Showing Difference Between Wire Gauges in Decimal Parts of an Inch.

Number of Wire Gauge.	American Steel and Wire Co. or Washburn & Moen.	Birmingham or Stubs'	American or Brown & Sharpe's.	English Legal Standard.	Old English or London.
0	.307	.340	.32495	.324	.340
1	.283	.300	.28930	.3	.300
2	.263	.284	.25763	.276	.284
3	.244	.259	.22942	.252	.259
4	.225	.238	.20431	.232	.238
5	.207	.220	.18194	.212	.220
6	.192	.203	.16202	.192	.203
7	.177	.180	.14428	.176	.180
8	.162	.165	.12849	.16	.165
9	.148	.148	.11443	.144	.148
10	.135	.134	.10189	.128	.134
11	.120	.120	.09074	.116	.120
12	.105	.109	.08080	.104	.109
13	.092	.095	.07196	.092	.095
14	.080	.083	.06408	.08	.083
15	.072	.072	.05706	.072	.072
16	.063	.065	.05082	.064	.065
17	.054	.058	.04525	.056	.058
18	.047	.049	.04030	.048	.049
19	.041	.042	.03589	.04	.040
20	.035	.035	.03196	.036	.035
21	.032	.032	.02846	.032	.0315
22	.028	.028	.025347	.028	.0295
23	.025	.025	.022571	.024	.027
24	.023	.022	.0201	.022	.025
25	.020	.020	.0179	.02	.023
26	.018	.018	.01594	.018	.0205
27	.017	.016	.014195	.0164	.01875
28	.016	.014	.012641	.0148	.0165
29	.015	.013	.011257	.0136	.0155
30	.014	.012	.010025	.0124	.01375
31	.0135	.010	.008928	.0116	.01225
32	.0130	.009	.00795	.0108	.01125
33	.0110	.008	.00708	.01	.01025

JUNIATA GALVANIZED SHEETS.

BEST BLOOM.

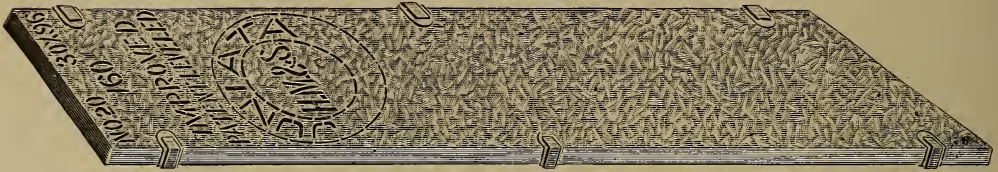

Numbers	†12	14	16	18	20	22	24	26	27	28	30
List, per pound	\$0.12	.12	.12	.13	.13	.14	.14	.15	.16	.17	.21
Weight per square foot, lbs..	4.531	3.281	2.656	2.156	1.656	1.406	1.156	.9062	.8437	.7812	.6562

Iron 36 inches wide, No. 20 and Lighter, one cent higher than above.

Table showing our stock sizes with code words, weights in pounds of bundles, and number of sheets in one bundle.

Gauges.	†12		14		16		18		20	
	Code Word.	No. of Sheets. Weight of Bundle.	Code Word.	No. of Sheets. Weight of Bundle.	Code Word.	No. of Sheets. Weight of Bundle.	Code Word.	No. of Sheets. Weight of Bundle.	Code Word.	No. of Sheets. Weight of Bundle.
†24x 72	Festemus...	3 163	Festness...	4 157	Fetandre ...	5 159	Feteless.....	6 155	Fetifce.....	8 159
†24x 84	Festering...	2 127	Fetacage....	3 138	Fetardo ...	4 149	Fetelia	5 151	Fetified.....	7 162
24x 96	Festeval ...	2 145	Fetacest....	3 157	Fetarsite ...	4 170	Fetening ...	4 138	Fetirte	6 159
†30x 72	Fetacons ...	3 148	Fetarvat ...	4 159	Feteraste ...	5 162	Fetivoler ...	6 149
†30x 84	Festique....	2 159	Fetadion ...	3 172	Fetaumer... 3	139	Feteratio ...	4 151	Fetmar.....	5 145
30x 96	Festoir	2 181	Fetagito ...	2 131	Fetavaro.... 3	159	Feterous ...	4 172	Fetolius....	5 166
†30x108	Fetomake...	4 150
†30x120	Fetazella... 2	133	Feteschet... 3	162	Fetonic.....	4 166
†36x 72
†36x 84
36x 96	Fetalogia... 2	157	Feteciss.... 2	127	Fetibono ... 3	155	Fetral	4 159
†36x120	Fetampsy .. 2	197	Fetegma ... 2	159	Fetucos	2 129	Fetrim	3 149

Gauges.	22		24		26		27		28	
	Code Word.	No. of Sheets. Weight of Bundle.	Code Word.	No. of Sheets. Weight of Bundle.	Code Word.	No. of Sheets. Weight of Bundle.	Code Word.	No. of Sheets. Weight of Bundle.	Code Word.	No. of Sheets. Weight of Bundle.
†24x 72	Petrock	9 152	Feuchon....	11 153	Feumilch... 14	152	Feusides....	15 152	Fevalang...	16 150
†24x 84	Fetspan	8 158	Feudant....	9 146	Feumoes ... 12	152	Feutiche... 13	154	Fevalling...	14 153
24x 96	Fetstun.....	7 157	Feudist....	8 148	Feumoire ... 10	145	Feutimos ... 11	148	Fevandi.....	12 150
†30x 72	Fettelar ...	7 148	Fengeld ...	9 156	Feuregel ... 11	149	Feutore ...	12 152	Fevagraf ...	13 152
†30x 84	Fettelhaft ..	6 148	Feuglant... 7	142	Feuroso ...	10 159	Feutude ...	10 148	Fevaito.....	11 150
30x 96	Fetterave... 5	141	Feugliar... 7	162	Feursord... 8	145	Feuzien ...	9 152	Fevelure ...	10 156
†30x108	Fettonica... 5	158	Feuklad... 6	153	Feurston ... 8	168
†30x120	Fetung	4 141	Feukol.... 5	145	Feurtia ...	7 159	Feuzolt.... 7	148
†36x 72	Feukrup... 7	146	Feusermo.. 9	147
†36x 84	Feukster ... 6	146
36x 96	Fetulare.... 5	169	Feulsmeid . 6	166	Feusias ... 7	152	Feuzug..... 8	162
36x120	Feturio.... 4	169	Feulswerk . 5	173

We also have No. 30 gauge in the following sizes: 24x84, 24x96, 30x96.

Code words are for Gauge and Size only, and do not cover quantities.

† Carried in San Francisco only.

BLACK SOFT STEEL SHEETS.

ONE PASS. COLD ROLLED. BOX ANNEALED.

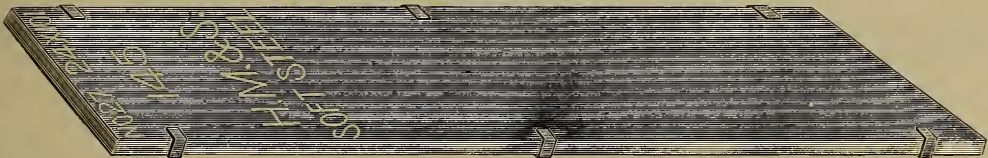

Numbers.....	14	16	18	20	22	24	26	27	28	†30
Per pound.....	\$.....

Table showing our stock sizes with code words, weights in pounds of bundles, and number of sheets in one bundle.

Gauges.	14			16			18			20			22		
	Size of Sheet.	Code Word.	No. of Sheets, Weight of Bundle.	Code Word.	No. of Sheets, Weight of Bundle.	Code Word.	No. of Sheets, Weight of Bundle.	Code Word.	No. of Sheets, Weight of Bundle.	Code Word.	No. of Sheets, Weight of Bundle.	Code Word.	No. of Sheets, Weight of Bundle.		
†24x 72	Fevendolo.	4	146	Fevolken...	5	144	Fewdiltf.....	6	141	Fewgiamo.	8	149	Fewrap.....	9	148
†24x 84	Feverello...	4	175	Fevorens...	5	175	Fewdracht.	6	168	Fewgruss...	8	168	Fewrays....	9	157
24x 96	Fevergeil...	3	150	Fevorismo.	4	160	Fewgaan...	5	160	Fewkennig	7	168	Fewreck....	8	160
24x101
26x 96
†30x 72	Fevernel...	3	141	Fewcane....	4	148	Fewgarid...	5	151	Fewkocht..	7	164	Fewrot.....	7	147
†30x 84	Fevestria...	3	164	Fewcaras...	4	175	Fewgeest...	5	175	Fewkrug....	6	157	Feycite.....	8	175
30x 96	Fevitura....	3	188	Fewdax.....	3	150	Fewgerum.	4	160	Fewlage....	5	180	Feyclim....	6	150

Gauges.	24			26			27			28			†30		
	Size of Sheet.	Code Word.	No. of Sheets, Weight of Bundle.	Code Word.	No. of Sheets, Weight of Bundle.	Code Word.	No. of Sheets, Weight of Bundle.	Code Word.	No. of Sheets, Weight of Bundle.	Code Word.	No. of Sheets, Weight of Bundle.	Code Word.	No. of Sheets, Weight of Bundle.		
†24x 72	Feycorant..	12	147	Fezetsel....	16	146	Fiabulos....	18	157	Fiadrom....	20	159
†24x 84	Fezadig....	11	154	Fezoard....	14	147	Fiacheto....	15	144	Fiadraph... 17	149	Fiarella ...	20	143	
24x 96	Fezaner....	10	160	Fezong.....	12	144	Fialepse....	15	150	
24x101	Fezantes ...	9	152	Fezote.....	12	151	Fiaconie....	13	150	Fialima	14	148	
†26x 96	
†30x 72	Fezenheid..	10	156	Fezudas....	13	151	Fiacope....	14	147	Fiallus....	16	153	
†30x 84	Fezestan ...	9	157	Fiabella....	11	144	Fiademus... 13	156	Fialogas....	14	153		
30x 96	Fezetha....	8	160	Fiablura....	10	150	Fiadoco....	11	151	Fiamante... 17	150		

Code words are for Gauge and Size only, and do not cover quantities.

† **BLACK GOLDEN GATE SHEET IRON.**

FREE FROM SMUT. PATENT LEVELED. UNIFORM COLOR.

24x101 Inches.

Code.....	Fibastir	Fibolim	Fibosco
Numbers.....	26	27	28
Per pound.....	\$.....

WELLSVILLE POLISHED STEEL.



†28x101 Inches.

Code.....	Fibrocat	Fibroch	Fibrutt	Ficarcho
Numbers.....	24	25	26	27
Per pound.....	\$.....

In bundles. Average weight of bundles 155 pounds.

24x101 Inches.

Code.....	Ficarcirt	Ficarcop	Ficarcum	Ficardant	Ficaretta
Number.....	†24	†25	†26	27	†28
Per pound.....	\$.....

In bundles. Average weight of bundles, 150 pounds.

WOODS' PATENT PLANISHED SHEET IRON.

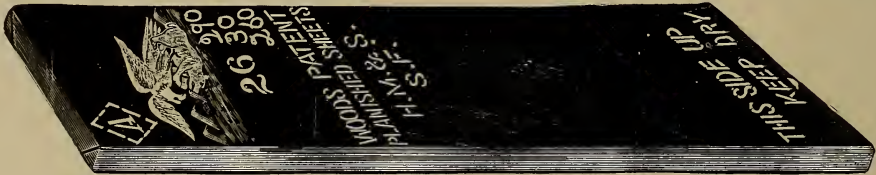

“A” Quality. 28x60 Inches.

Code.....	Ficarpet	Ficaster	Ficator	Ficevolet	Fichase	Fichelop	Fichiar
Numbers.....	†20	†22	†24	†25	†26	27	†28
Weight per sheet, lbs.....	16.5	13.5	11.	10.	9.	8.5	8.
Per pound.....	\$.....

†“A” Quality. 28x72 Inches.

Code.....	Fichinot
Number.....	22
Weight per sheet, lbs.....	16.25
Per pound.....	\$.....

†“B” Quality. 28x60 Inches.

Code.....	Fichloir	Fichoden	Fichorum	Ficibolus	Ficibuler
Numbers.....	24	25	26	27	28
Weight per sheet, lbs.....	11.	10.	9.	8.5	8.
Per pound.....	\$.....

Put up in metal cases or packs, with wood backs. Takes same rate of freight as Black Iron.

Average weight of cases or packs, 290 pounds.

Average Number of Sheets in a Pack.

Number of iron.....	20	22	24	25	26	27	28
Number of sheets.....	16	19	23	25	29	30	32

‡ Carried in Los Angeles only.

† Carried in San Francisco only.

CORRUGATED ROOFING.

BLACK STEEL. PAINTED RED.



6 to 10 feet long, 26 inches wide.

Twenty-six inches wide after corrugating. Two and one-half inch corrugations.

Allowing for lap of one corrugation it lays twenty-four inches to the weather.

Numbers.....	†24	†26	†27	†28
Weight per square, lbs.....	110	83	76	69
Per square.....	\$.....

Table Showing Number of Sheets in a Square, and Code Words.

Gauges.		†24	†26	†27	†28
Length of Sheets. Inches.	Number of Sheets to a Square.	Code Word.	Code Word.	Code Word.	Code Word.
72	7.692	Ficitorem.....	Ficraniot.....	Fidamure.....	Fidelphor.
84	6.593	Ficlapod.....	Ficranur.....	Fidascal.....	Fideltar.
96	5.769	Ficlinate.....	Ficrotus.....	Fidattis.....	Fidendos.
108	5.128	Ficomast.....	Ficrudat.....	Fidattic.....	Fidicer.
120	4.616	Ficotomi.....	Fidame.....	Fideaux.....	Fidimel.

Table Showing the Number of Square Feet Necessary to Cover a Square of 100 Square Feet of Surface.

The table is based on using ninety-six inch sheets. When longer or shorter sheets are used the number of square feet will vary slightly.

Allowing for side lap of one corrugation:

Allowing for end lap.....	1 inch	2 inches	3 inches	4 inches	5 inches	6 inches
Square feet.....	110	111	112	113	114	115

‡ Carried in Los Angeles only.
† Carried in San Francisco only.

CORRUGATED ROOFING.

GALVANIZED STEEL.



6 to 10 feet long, 27 inches wide.

Twenty-seven inches wide after corrugating. Two and five-eighths inch corrugations. Allowing for lap of one corrugation, iron lays twenty-four inches to the weather.

Numbers.....	† 22	† 24	26	† 27	† 28
Weight per square, lbs.....	152	124	98	91	85
Per pound	\$.....

Table Showing Number of Sheets in a Square, and Code Words.

Gauges.		† 22	† 24	26	† 27	† 28
Length of Sheets, Inches.	Number of Sheets to a Square.	Code Word.	Code Word.	Code Word.	Code Word.	Code Word.
72	7.692	Fidintros	Fiducer	Fiefturn.....	Fienerlo	Fierbach.
84	6.593	Fidiplas	Fiductis	Fiefwall.....	Fienstag.....	Fierecto.
96	5.769	Fidituro	Fiduncal.....	Fielento	Fiepert	Fierenet.
108	5.128	Fidonum	Fiduxer.....	Fiemite	Fiepsel	Fierenler.
120	4.616	Fidrimit	Fiefstall.....	Fienend.....	Fierbaar	Fieresift.

† H. M. & S. PLAIN RIDGE CAP.

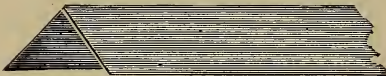

PAINTED.

Code.....	Fieretical	Fiergard
Size, inches.....	7 1/2 x 7 1/2	7 1/2 x 7 1/2
Gauge of iron	24	26
Weight per foot, lbs.....	1.25	1.10
Per foot.....	\$0.28	.22

† H. M. & S. PLAIN RIDGE CAP.

GALVANIZED.

Code	Fiergraph	Fiermen	Fieront	Fiersort	Fierville	Fiervorm	Fiesante	Fieserhal
Size, inches	4x4	6x6	7 1/2 x 7 1/2	12x12	4x4	6x6	7 1/2 x 7 1/2	12x12
Gauge of iron	24	24	24	24	26	26	26	26
Weight per foot, lbs.....	.67	1.00	1.25	2.00	.60	.88	1.10	1.75
Per foot.....	\$0.18	.26	.30	.48	.16	.22	.28	.44

Made in sections six feet long.

† H. M. & S. FANCY RIDGE CAP.

GALVANIZED.

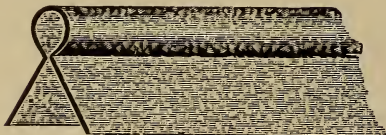

Code	Fiesmalk	Fiespite
Size, inches	8x8	8x8
Gauge of iron	24	26
Weight per foot, lbs.....	1.83	1.60
Per foot.....	\$0.54	.46

Made in sections six feet long.

Any size, style or weight ridge cap made to order.

† Carried in San Francisco only.

U. S. STANDARD GAUGE.

For Sheet and Plate Iron and Steel.

Approved, March 3, 1893.

(Copy)

[Public—No. 137.]

An act establishing a standard gauge for sheet and plate iron and steel.

Be it enacted by the Senate and House of Representatives of the United States of America in Congress assembled, That for the purpose of securing uniformity the following is established as the only standard gauge for sheet and plate iron and steel in the United States of America, namely :

Number of Gauge.	Approximate Thickness in Fractions of an Inch.	Approximate Thickness in Decimal Parts of an Inch.	Weight per Square Foot in Ounces Avoirdupois.	Weight per Square Foot in Pounds Avoirdupois.
0000000	1/2	.5	320	20.00
000000	1 5/32	.46875	300	18.75
00000	7/16	.4375	280	17.50
0000	1 3/32	.40625	260	16.25
000	3/8	.375	240	15.
00	1 1/32	.34375	220	13.75
0	5/16	.3125	200	12.50
1	9/16	.28125	180	11.25
2	1 7/64	.265625	170	10.625
3	1/4	.25	160	10.
4	1 5/64	.234375	150	9.375
5	7/32	.21875	140	8.75
6	1 3/64	.203125	130	8.125
7	3/16	.1875	120	7.5
8	1 1/64	.171875	110	6.875
9	5/32	.15625	100	6.25
10	9/64	.140625	90	5.625
11	1/8	.125	80	5.
12	7/64	.109375	70	4.375
13	3/32	.09375	60	3.75
14	5/64	.078125	50	3.125
15	9/128	.0703125	45	2.8125
16	1/16	.0625	40	2.5
17	9/160	.05625	36	2.25
18	1/20	.05	32	2.
19	7/160	.04375	28	1.75
20	3/80	.0375	24	1.50
21	1 1/320	.034375	22	1.375
22	1/32	.03125	20	1.25
23	9/320	.028125	18	1.125
24	1/40	.025	16	1.
25	7/40	.021875	14	.875
26	3/320	.01875	12	.75
27	1 1/640	.0171875	11	.6875
28	1/64	.015625	10	.625
29	9/640	.0140625	9	.5625
30	1/80	.0125	8	.5
31	7/640	.0109375	7	.4375
32	1 3/1280	.01015625	6 1/2	.40625
33	3/320	.009375	6	.375
34	1 1/320	.00859375	5 1/2	.34375
35	5/640	.0078125	5	.3125
36	9/1280	.00703125	4 1/2	.28125
37	1 7/2560	.006640625	4 1/4	.265625
38	1/160	.00625	4	.25

And on and after July first, eighteen hundred and ninety-three, the same and no other shall be used in determining duties and taxes levied by the United States of America on sheet and plate iron and steel. But this act shall not be construed to increase duties upon any articles which may be imported.

Sec. 2. That the Secretary of the Treasury is authorized and required to prepare suitable standards in accordance herewith.

Sec. 3. That in the practical use and application of the standard gauge hereby established a variation of two and one-half per cent either way may be allowed.

† **TIN NAIL HEADS.**

Code..... Fiesterus
 Diameter, inch..... 1
 Number to lb..... 414
 Per pound..... \$0.20



† Carried in San Francisco only.

† **LEAD WASHERS.**

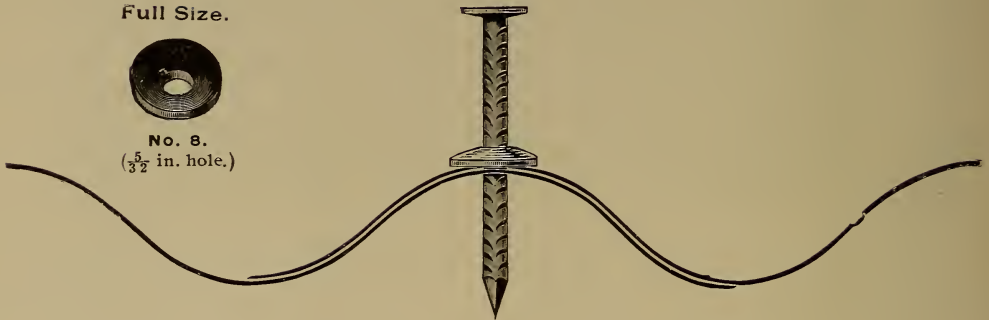

Code.....	Fiespitris
Number.....	8
Size, inch.....	1/2
Number to lb.....	325
Per pound.....	\$0.44

One pound will lay three squares. Five pounds in a box. One-hundred pounds in a case.

† **ROOFING NAILS.**



Code.....	Fiesqack	Fietare	Fietator	Fieterde
Size, inches.....	7/8x14	7/8x13	1x12	2x10
Style.....	Tinned	Bright	Bright	Bright
Number to a pound.....	600	415	384	124
Per pound.....	\$0.14	.12	.11	.11

Code.....	Fietesafo	Fietetico	Fievonn
Size, inches.....	1x12	2x10	1 1/4
Style.....	Galv. Barbed	Galv. Barbed	Blk. Cut
Number to a pound.....	411	115	464
Per pound.....	\$0.15	.13	.12

One hundred pounds in a keg.

† Carried in San Francisco only.

† **ESCUTCHEON PINS.**

BRASS.

No. 12.

Code.....	Fiexide	Fiexmado
Inch.....	$\frac{3}{4}$	$\frac{7}{8}$
Per pound.....	\$0.73	0.72

No. 14.

Code.....	Fiexmara	Fiexmesin	Figamon	Figastric	Figenesi
Inch.....	$\frac{1}{2}$	$\frac{5}{8}$	$\frac{3}{4}$	$\frac{7}{8}$	1
Per pound	\$0.77	.76	.75	.74	.73

No. 16.

Code.....	Figenette	Figenez
Inch.....	$\frac{5}{8}$	$\frac{3}{4}$
Per pound.....	\$0.80	.78

One pound in a box.

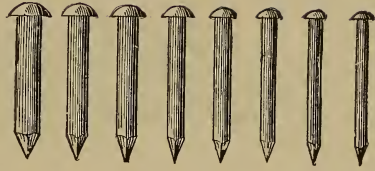

† **TINNED OVAL HEAD TACKS.**

Code.....	Figenism	Figentiar	Figerable
Ounces.....	8	10	12
Length, inch.....	$\frac{9}{16}$	$\frac{10}{16}$	$\frac{11}{16}$
Per dozen papers.....	\$1.10	1.30	1.50

Code.....	Figaranto	Figarendum	Figerido
Ounces.....	14	16	18
Length, inch.....	$\frac{12}{16}$	$\frac{13}{16}$	$\frac{14}{16}$
Per dozen papers.....	\$1.80	2.00	2.20

One dozen papers in a package.

† Carried in San Francisco only.

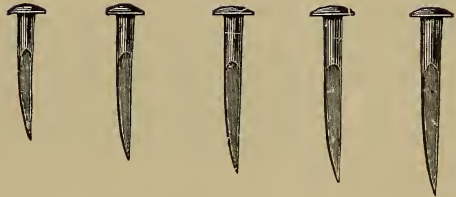

† H. M. & S. GALVANIZED CUTTERING OR EAVES TROUGH.

PLAIN BEADED. IRON No. 26 GAUGE.



Code.....	Figestirl	Figestive	Figestoram	Figestur
Size, inches.....	4	5	6	8
Per foot	\$0.17½	.21	.23
Weight per 100 feet, lbs	105	128	157	203
Shipping measurement per 100 feet, cubic feet	5	5½	6½	9½

Made in six-foot lengths. Any size, style or weight made to order.

† H. M. & S. GALVANIZED CUTTERING OR EAVES TROUGH.

BEADED WITH FLANGE. IRON No. 26 GAUGE.

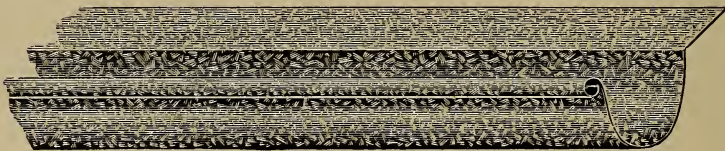

Code.....	Figgably	Figitabul	Figitalic	Figitanos
Size, inches.....	4	5	6	8
Per foot	\$.....
Weight per 100 feet, lbs	135	165	195	204
Shipping measurement per 100 feet, cubic feet	7½	10½	12	14½

Made in six-foot lengths. Any size, style or weight made to order.

† IMPERIAL CUTTER HANGERS.

WITH RODS. FOR FIVE-EIGHTHS] BEAD.

Code	Figitanute	Figitape	Figitapil	Figitate
Size, inches	4	4½	5	6
Per gross	\$7.10	7.30	7.60	8.50
Weight per gross, lbs	37	38	42	47
Tongs to apply Hangers, each.....				\$0.75

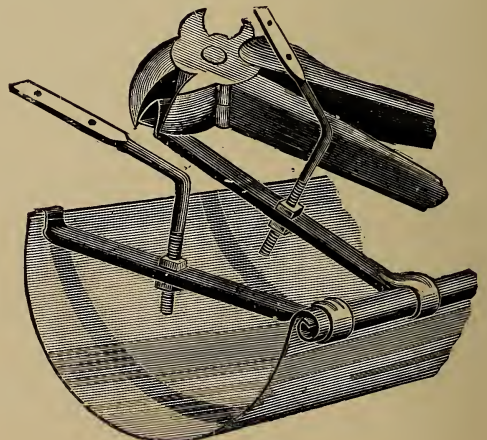

† Carried in San Francisco only.

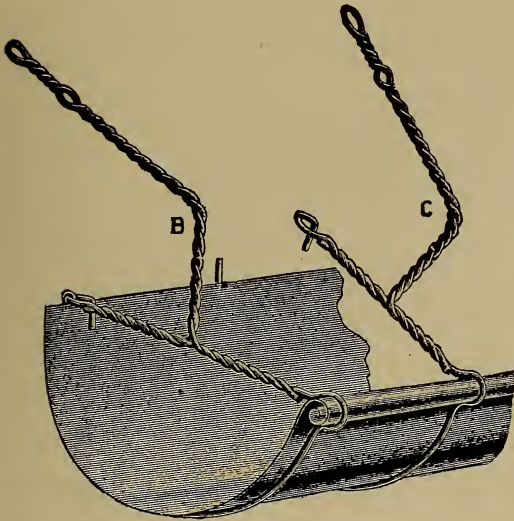

† **WIRE GUTTER HANGERS.**

FOR FIVE-EIGHTHS BEAD

This hanger is made of best galvanized steel wire; can be quickly and easily adjusted to the gutter, and is the only wire hanger forming a complete brace as well as hanger.

Code	Figitateal	Figitateam	Figitateas	Figitateap
Size, inches	4	4½	5	6
Per gross ...	\$2.25	2.50	2.70	3.15
Weight per gross, lbs.	23	25	26	33½

One gross in a package.

† Carried in San Francisco only.

EAVE TROUGH MITERS.

INSIDE CORNER. GALVANIZED IRON.
PLAIN BEADED.

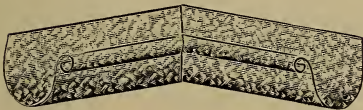

Code.....	Figitatear	Figitatebo	Figitated	Figitateke
Numbers	4-I	5-I	6-I	8-I
Inches.....	4	5	6	8
Each.....	\$.....
Wgt. each, lbs..	1	1½	1¼

Any size, style or weight made to order.

EAVE TROUGH MITERS.

OUTSIDE CORNER. GALVANIZED IRON.
PLAIN BEADED.

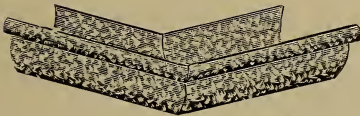

Code.....	Figitatell	Figitatep	Figitaters	Figitatic
Numbers	4-0	5-0	6-0	8-0
Inches.....	4	5	6	8
Each.....	\$.....
Wgt. each, lbs..	1	1½	1¼

Any size, style or weight made to order.

EAVE TROUGH OUTLETS.

GALVANIZED IRON.



Code.....	Figitatide	Figitatif	Figitatige	Figitatiko
Inches.	4	5	6	8
Each.....	\$.....
Wgt. each, lbs..

Any size, style or weight made to order.

EAVE TROUGH ENDS WITH OUTLETS.

GALVANIZED IRON.



Code.....	Figatilis	Figatitom	Figatitoni	Figitatus
Inches.....	4	5	6	8
Outlets, inches..	2	3	4	6
Each.....	\$.....
Wgt. each, lbs..

Any size, style or weight made to order.

† **H. M. & S. GALVANIZED CONDUCTOR PIPE.**

STRAIGHT SEAM. SOLDERED.



Code.....	Figitavan	Figitello	Figitifer	Figitino	Figitorum
Inches.....	2	3	4	5	6
Gauge of iron.....	28	27	27	27	27
Per foot	\$0.10	.10½	.14	.17	.20
Weight per 100 feet, lbs.	52	74	99	121	150
Shipping measurements per 100 feet, cubic feet.....	7½	13	20½	29¾	40

Made in seven and one-half foot lengths. Any size or weight made to order.

† Carried in San Francisco only.

GALVANIZED STRAIGHT SEAMED CONDUCTOR PIPE.

PLAIN ROUND LOCK SEAMED No. 28 IRON.

For Leader or Conductor Spouts, Ventilating, Heating Blast, Hot Air and Blower Pipe. Each length is a single perfect piece.



Code	Figtitit	Figkarm	Figkasut	Figkatig	Figkerm	Figkerque	Figkersy
Inches	1½	2	2½	3	4	5	† 6
Per foot.....	\$0.13	.13	.15	.15	.20	.25	.30
Weight per 100 feet, lbs.....	32	42	51	59	77	97	121
Shipping measure per 100 feet, cubic feet.	3¼	5½	10	16	29½	...	39

Made in 10-foot lengths.

† Carried in San Francisco only.

GALVANIZED SPIRAL CONDUCTOR PIPE.



Code.....	Figladiar	Figlifor	Figloss	Figndes	Figmand	Fignares	Fignaturo
Inches	† 1	1½	2	3	4	† 5	† 6
Per foot.....	\$0.08	.05	.06	.10	.13½	.30	.38
Weight per 100 feet, lbs.....	15	27	36	60	80	90	120
Shipping measurements per 100 feet, cu. ft.....	2	3¼	5¼	10½	16¾	29½	39

The 1-inch is straight seamed. The 1, 1½, 2, 3 and 4-inch made in 6-foot lengths.
The 5 and 6-inch made in 10-foot lengths.

† **GALVANIZED ROUND CORRUGATED EXPANDING CONDUCTOR.**

IRON. No. 28 GAUGE.



Code	Fignidate	Fignitair	Fignitare	Figniteck	Fignitface
Inches.....	2	3	4	5	6
Per foot.....	\$0.13	.15	.20	.25	.30
Weight per 100 feet, lbs.....	45	55	84	100	125
Shipping measurements per 100 feet, cubic feet.....	5½	10	16	29½	39

Made in 10-foot lengths.

ADJUSTABLE CONDUCTOR ELBOWS.

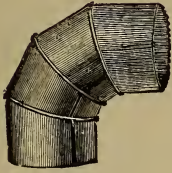

GALVANIZED.

Code.....	Fignitoso	Fignotion	Figozzam	Figozzarl
Inches.....	1½	2	2½	3
Each	\$0.20	.20	.25	.30
Wt. per doz., lbs...	2¼	3	4¼	5½
Code.....	Figozzera	Figradarli	Figradas	
Inches	4	† 5	† 6	
Each	\$0.40	.55	.70	
Weight per doz., lbs.....	8	11	15	

† CORRUGATED EXPANDING CONDUCTOR ELBOWS.



GALVANIZED. ROUND.

Code.....	Filabido	Filabiter	Filabunto	Filabunxo	Filabunzo
Inches	2	3	4	5	6
Each	\$0.25	.30	.40	.45	.50
Weight per doz., lbs.	2½	5½	8	11	15

† CONDUCTOR PIPE HOOKS.



GALVANIZED. STEEL.

Code.....	Filacando	Filacassi	Filacerad	Filacfast	Filacgut
Inches	2	3	4	5	6
Shank, inches....	3	3½	4	4½	6
Each	\$0.10	.12	.15	.20	.25
Weight per 100, lbs....	12	24	41	61	78

† H. M. & S. CONDUCTOR HEADS.

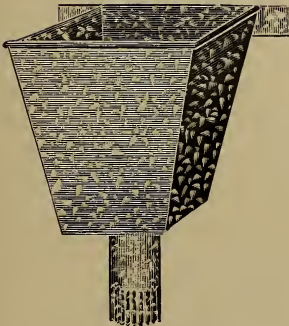

GALVANIZED.

Code.....	Filacion	Filamass	Filaminat	Filancian
Outlet, inches.....	1½	2	2½	3
Top, inches.....	6x6	6x6	6½x6½	7x7
Height, inches.....	6½	6½	7	7
Per dozen.....	\$5.25	5.25	5.50	6.35
Wt. per doz., lbs...	14	15	18	20
Code	Filapidas	Filapkast	Filapol	Filapsion
Outlet, inches.....	4	5	6	7
Top, inches	8½x8½	9½x9½	11x11	11½x11½
Height, inches.....	8	9	10½	11½
Per dozen.....	\$8.00	12.00	16.00	18.00
Weight per doz., lbs....	26	37	48	54

† Carried in San Francisco only.

† WIRE CONDUCTOR STRAINERS.

GALVANIZED.

Code	Filapsura	Filargime
Inches.....	2	3
Per dozen	1.50	2.00
Wt. per doz., lbs.....	1½	2

Code.....	Filargirt	Filatata	Filatamis
Inches.....	4	5	6
Per dozen.....	\$3.00	5.00	6.00
Wt. per doz., lbs.....	4	6	8

One gross in a barrel.

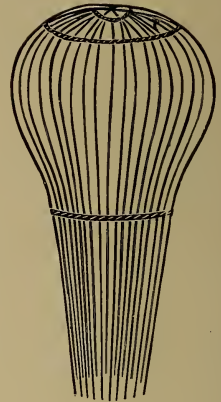

STANDARD SPEAKING TUBES.

LOCK SEAM.

Code.....	Filatandi	Filatative
Style.....	Tin	†Galvanized
Inch.....	1	1
Per foot.....	\$0.02½	.08
Weight per 100 feet, lbs.....	14	15
Shipping measurements per crate, cubic feet.....	40



Made in 5-foot lengths. 100 feet in a bundle.
5000 feet in a crate.

SPEAKING TUBE ELBOWS.

TIN.

Code	Filatarm	Filation
Style	†Square	Round
Inch	1	1
Each.....	\$0.06	.06½
Weight per 100, lbs.....	4½	4½

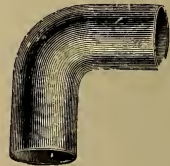

† Carried in San Francisco only.

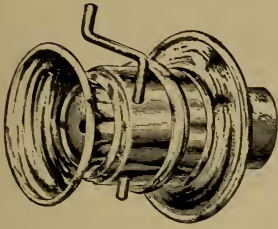

† **SPEAKING TUBE WHISTLES.**

EXTRA STRONG. NICKEL-PLATED.

Code	Filatore
Number.....	157
Style	Without Indicator
Per dozen	\$13.00
Weight per dozen, lbs.....	2

One dozen in a box.

† **SPEAKING TUBE WHISTLES.**

PORCELAIN MOUTH PIECE. JAPANED BODY.

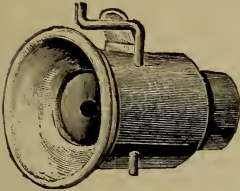

Code	Filatorum	Filaudam
Numbers.....	158	159
Style	With Indicator	Without Indicator
Per dozen.....	\$4.00	4.00
Weight per dozen, lbs.....	2	2

One dozen in a box.

† **SPEAKING TUBE WHISTLES.**

NICKEL-PLATED. NO SPRINGS.

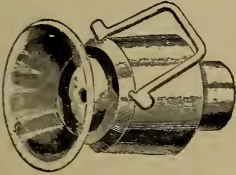

Code.....	Filauto	Filectare
Numbers	1158 1/2	1159 1/2
Style	With Indicator	Without Indicator
Per dozen.....	\$7.00	6.00
Weight per dozen, lbs.....	1 1/4	1 1/4

One dozen in a box.

† **SPEAKING TUBE WHISTLES.**

NICKEL-PLATED. WITH LOOSE FLANGES.
BEVELED PATTERN.

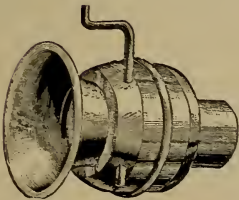

The best whistle for flexible tubes.

Code	Filectorit
Number.....	152
Style	With Indicator
Per dozen.....	\$12.00
Weight per dozen, lbs.....	1 1/4

One dozen in a box.

SPEAKING TUBE WHISTLES.

NICKEL-PLATED BRASS.

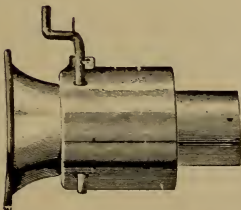

Code	Filemmato	Filelican
Numbers	158 1/2	† 159 1/2
Style	With Indicator	Without Indicator
Per dozen.....	\$6.00	6.00
Weight per dozen, lbs.....	1 1/4	1 1/4

One dozen in a box.

† Carried in San Francisco only.

CHARCOAL BRIGHT AND TERNE PLATES.

We carry a large and complete stock of all standard sizes and weights of Bright and Terne Plates, also many odd sizes.

Our stock is made from domestic Black Steel Plates, manufactured especially for us. They are more satisfactory than imported Plates, being tougher and more malleable. They are thoroughly and evenly coated.

† PLACER CHARCOAL TIN.

BRIGHT—GOOD GRADE.



Code.	Trade Term.	Size, Inches.	Sheets in a Box.	Gross Weight, Lbs.	Wire Gauge.	Per Box.
Finigra.....	\$.....
Finion.....
Finkelkor.....	100-lb.	20x28	112	210	31
Finobry.....	IC	12x12	225	117	30
Finoccam.....	IC	14x20	112	113	30
Finocand.....	IC	20x28	112	225	30
Finocasse.....	IXL	14x20	112	135	29
Finoccate.....	IXL	20x28	112	268	29
Finocelar.....	IX	12x12	225	146	28
Finochari.....	IX	14x20	112	142	28
Finocorus.....	IX	20x28	112	284	26½
Finocrate.....	IXX	14x20	112	162	28

BELMONT CHARCOAL TIN.

BRIGHT—EXTRA GRADE. TISSUE PAPER PACKED.



Code.	Trade Term.	Size, Inches.	Sheets in a Box.	Gross Weight, Lbs.	Wire Gauge.	Per Box.
Finogeta.....	† IC	12x12	225	117	30	\$.....
Finoloch.....	† IC	14x14	225	160	30
Finomach.....	IC	14x20	112	113	30
Finomene.....	IC	20x28	112	225	30
Finomorph.....	† IX	12x12	225	145	28
Finornas.....	† IX	14x14	225	200	28
Finosauri.....	IX	14x20	112	142	28
Finosceba.....	† IX	16x16	225	260	28
Finoscend.....	IX	20x28	112	285	28
Finoscim.....	† IXX	12x12	225	168	26½
Finother.....	† IXX	14x14	225	228	26½
Finoverum.....	IXX	14x20	112	163	26½
Finovittle.....	† IXX	16x16	225	283	26½
Finoxid.....	IXX	20x28	112	322	26½
Fintelamo.....	† IXXX	14x20	112	183	25½
Fintelase.....	IXXX	20x28	112	362	25½
Fintenlos.....	† IXXXX	14x20	112	204	25
Fintenman.....	IXXXX	20x28	112	404	25

4 X, 14 x 20, 1 X, 2 X, 16 x 16 and 2 X, 3 X, 4 X, 20 x 28 carried in half boxes.

† Carried in San Francisco only.

† **STERLING CHARCOAL TIN.**



BRIGHT. EXTRA HEAVY COATED.

For Dairy Work. Tissue Paper Packed.

Code.	Trade Term.	Size, Inches.	Sheets in a Box.	Gross Weight, Lbs.	Wire Gauge.	Per Box.
Fintensat.....	IXX	20x28	112	322	26½	\$.....
Fintentop.....	IXXX	20x28	112	362	25½
Fintenzeg.....	IXXXX	20x28	112	404	25

All of above carried in half boxes of 56 sheets only.

**LARGE TIN PLATES—
BEST QUALITY.**

FOR DAIRY WORK.



Code.	Trade Term.	Size, Inches.	Wt. per Sheet, Lbs.	Per Lb.
Finteraro.....	IXXXX	20x60	8	\$.....
Fintornam.....	†IXXXX	28x48 ½	9
Fintornos.....	†IXXXX	28x66	12¼
Finumerab.....	IXXXX	30x72	15
Fioblar.....	IXXXX	30x84	20
Fiochare.....	†IXXXX	36x87	21
Fiocharin.....	†IXXXX	40x96	27
Fiocmita.....	†IXXXXXX	28x66	16
Fiodimos.....	†IXXXXXX	40x72	22
Fiodoras.....	†IXXXXXX	40x84	26
Fiogeni.....	IXXXXXX	40x96	29
Fiogenise.....	†IXXXXXX	30x84	24½

BESSEMER COKE TIN PLATES.



REGULAR SIZES.

Code.	Trade Term.	Size, Inches.	Sheets in a Box.	Gross Weight, Lbs.	Wire Gauge.	Per Box.
Fiognita.....	†80-lb.	20x28	112	170	33	\$.....
Fiognatus.....	90-lb.	14x20	112	96	32
Fiomphal.....	90-lb.	20x28	112	190	32
Fiopater.....	100-lb.	14x20	112	106	31
Fiophane.....	100-lb.	20x28	112	210	31
Fioptrico.....	IC	14x20	112	113	30
Fioptrism.....	IC	20x28	112	224	30
Fiorchit.....	†IX	14x20	112	142	28
Fioretique.....	IX	20x28	112	283	28

† Carried in San Francisco only.

BESSEMER COKE TIN PLATES.

SQUARE AND ODD SIZES.

Code.	Trade Term.	Size, Inches.	Sheets in Box.	Gross Weight, Lbs.	Wire Gauge.	Per Box.
Fiorthar.....	†90-lb.	12x12	225	99	32	\$.....
Fiosapul.....	†90-lb.	10x17	225	109	31
Fioscodi.....	†100-lb.	12x12	225	109	31
Fioscorem.....	†100-lb.	10x17	225	129	31
Fioskuro.....	†100-lb.	10x20	225	150	31
Fipanaro.....	†100-lb.	10x21	225	158	31
Fipanate.....	†100-lb.	11x22	225	192	31
Fipanavan.....	†100-lb.	12x17	225	154	31
Fipartenzo.....	†100-lb.	12x18	225	174	31
Fipaschel.....	†100-lb.	14x14	225	148	31
Fipelamo.....	†100-lb.	14x22	112	117	31
Fipelassi.....	†100-lb.	15x15	225	170	31
Fipelera.....	†100-lb.	15x22	112	125	31
Fipetal.....	†100-lb.	16x16	225	194	31
Fipingemo.....	100-lb.	17x17	225	218	31

11x22, 12x18, 17x17 carried in half boxes of 112 sheets.

The terms "Coke" and "Charcoal" originally denoted the grade of iron from which the plates were made but as all American plates are made of Bessemer steel, these terms have lost their original meaning and now signify only the different thicknesses of coating which the plates receive, the Coke plates having the lightest coatings and the Charcoal the heaviest.

CHARCOAL ROOFING PLATES.

MENLO—OLD PROCESS.



MENLO
Each sheet stamped: **OLD PROCESS**
H. M. & S.

Very best quality. Made by old palm oil process. Squared. Forty pounds of coating for a box of 20 x 28

Code.	Trade Term.	Size, Inches.	Sheets in Box.	Gross Weight, Lbs.	Per Box.
Fipinturo.....	IC	14x20	112	125	\$.....
Fiplander.....	IC	20x28	112	250
Fiplarena.....	† IX	14x20	112	152
Fiplasic.....	† IX	20x28	112	304

IX, 20x28 in half boxes.

ROYAL—OLD STYLE—RE-DIPPED.

HEAVY COATED. SQUARED.

ROYAL
Each sheet stamped: **OLD STYLE**
H. M. & S.

Code.	Trade Term.	Size, Inches.	Sheets in Box.	Gross Weight, Lbs.	Per Box.
Fiplazon.....	† IC	14x20	112	125	\$.....
Fiplectro.....	IC	20x28	112	250

†Carried in San Francisco only.

CHARCOAL ROOFING PLATES.

† **NON-RUSTING.**

RE-SQUARED AND STAMPED.



Code.	Trade Term.	Size, Inches.	Sheets in Box.	Gross Weight, Lbs.	Per Box.
Fipledant.....	†IC	20x28	112	235	\$.....

BERKELEY.

GOOD GRADE.



Code.	Trade Term.	Size, Inches.	Sheets in a Box.	Gross Weight, Lbs.	Per Box.
Fiplinth.....	100-lb.	14x20	112	106	\$.....
Fiplochil.....	100-lb.	20x28	112	212

POMONA.

GOOD GRADE.

Code.	Trade Term.	Size, Inches.	Sheets in a Box.	Gross Weight, Lbs.	Per Box.
Fiploder.....	†IC	14x20	112	113	\$.....
Fiplogeni.....	IC	20x28	112	225
Fiploidi.....	†IX	14x20	112	142
Fiplomaro.....	†IX	20x28	112	285

SHEET ZINC.



36 X 84 INCHES.

Code.	Number.	Weight per Sheet, Lbs.	Weight of Casks in Stock, Lbs.	Per Lb.	Code.	Number.	Weight per Sheet, Lbs.	Weight of Casks in Stock, Lbs.	Per Lb.
Fiplomati..	†4	600	\$.....	Firagnand	†10	15.75	600, 300, 200, 100	\$.....
Fiplomiter..	†5	600	Firagnate..	†11	18.90	600
Firadase....	†6	600	Firagnera	†12	22.05	600
Firadavan..	†7	600	Firamast...	†14	28.35	600
Firadere....	8	12.60	600, 300, 200, 100	Firancher..	†16	35.28	600
Firadican...	9	14.07	600, 300, 200, 100	Firandell..	†20	55.02	600

No. 20 is packed flat, eleven sheets in a case.

Additional charge is made for casks containing less than 600 pounds and for loose sheets.

†Carried in San Francisco only.

48 X 96 INCHES.

Code.	Number.	Weight per Sheet, Lbs.	Weight of Casks in Stock, Lbs.	Per Lb.	Code.	Number.	Weight per Sheet, Lbs.	Weight of Casks in Stock, Lbs.	Per Lb.
Firazzi.....	† 7	17	600	\$.....	Firefull....	11	28	600, 250	\$.....
Fircisla.....	8	19	600	Firemost ..	12	32	600
Firectara ...	9	22	600, 250, 100	Firempto ..	† 14	41	600
Firectiva....	10	24	600, 250, 100					

48 X 108 INCHES.

Code.	Number.	Weight per Sheet, Lbs.	Weight of Casks in Stock, Lbs.	Per Lb.	Code.	Number.	Weight per Sheet, Lbs.	Weight of Casks in Stock, Lbs.	Per Lb.
Fireptise ...	† 8	21	600	\$.....	Fireximos.	11	31	600, 250	\$.....
Firepturo...	9	24	600, 250	Firezion ...	† 12	36	600, 200
Firectory....	10	27	600, 250	Firebitore.	† 14	600

Additional charge is made for casks containing less than 600 pounds and for loose sheets.

TABLE SHOWING COMPARISON OF GAUGES ON SHEET ZINC.

ILLINOIS ZINC CO'S ZINC GAUGE.			STUBS' WIRE GAUGE.		BROWN & SHARPE'S GAUGE.	
No.	Weight per Square Foot.	Thickness in Decimals.	No.	Thickness in Decimals.	No.	Thickness in Decimals.
5	0.37	.010 ^{1/100}
6	0.45	.012	29	.013	29	.0112
7	0.52	.014	28	.014	28	.0126
8	0.60	.016	27	.016	27	.0141
9	0.67	.018	26	.018	26	.0159
10	0.75	.020 ^{1/50}	25	.020	25	.0179
11	0.90	.024	24	.022	24	.0201
12	1.05	.028	23	.025	23	.0225
13	1.20	.032	22	.028	22	.0253
14	1.35	.036	21	.032	21	.0284
15	1.50	.040 ^{1/25}	20	.035	20	.0319
16	1.68	.045	19	.042	19	.0359
17	1.87	.050	18	.049	18	.0403
18	2.06	.055	17	.058	17	.0452
19	2.25	.060 ^{1/17}	16	.065	16	.0508
20	2.62	.070	15	.072	15	.0570
21	3.00	.080	14	.083	14	.0640
22	3.37	.090	13	.095	13	.0719
23	3.75	.100 ^{1/10}	12	.109	12	.0808
24	4.70	.125 ^{1/8}	11	.120	11	.0907
25	9.40	.250 ^{1/4}	10	.134	10	.1019
26	14.00	.375 ^{3/8}	9	.148	9	.1114

† **SLAB ZINC OR SPELTER.**

Code..... Firigest

Per pound..... \$.....

In slabs of about fifty pounds each.

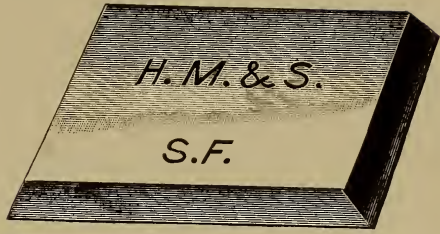

† **U. S. ANTIMONY.**

Code..... Firupos

Per pound..... \$.....

In slabs of about forty pounds each.
600 pounds in a barrel.

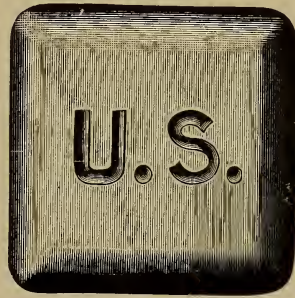

† **BAR LEAD.**

Code..... Firumpun

Per pound..... \$.....

One pound bars. Twenty-five bars in a bundle.



CAULKING LEAD.

Code..... Firupper

Per pound..... \$.....

Five pounds in a pig.



PIG LEAD.

Code..... Firuption

Per pound..... \$.....

About 100 pounds per pig.

† Carried in San Francisco only.



BAR TIN.

Code Firupturi
 Per pound..... \$.....
 One pound bars.



PIG TIN.

Code..... Fisalmot
 Per pound..... \$.....
 About fifty pounds per pig.



TINNERS' SOLDER.

Code..... Fisambil Fisamor Fisarmol
 Grade..... Extra X No. 1 No. 2
 Proportion of lead and tin ½ and ½ 90 to 100 80 to 100
 Per pound..... \$.....
 Two-pound bars. 100 pounds in a case.



TRIANGULAR SOLDER.

FOR CANNERS.

Code Fisattun Fisapot Fiscottar
 Grade..... Extra 2 †No. 1 †No. 2
 Per pound..... \$.....
 We can also furnish the above cut any size for Drop Solder.



† **WIRE SOLDER.**

FOR ELECTRICIANS.

Code..... Fisergote Fisestol
 Diameter, inch..... ¼ ⅜
 Per pound..... \$.....
 From five to fifty pounds in a coil.

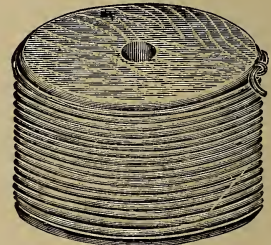

† **SPELTER SOLDER.**

FOR BRAZING.

Code..... Fisillable Fislacone Fispadano
 Grade..... Fine Medium Coarse
 Per pound..... \$.....
 † Carried in San Francisco only.





WIPING SOLDER.

Code..... Fistario Fistellu
 Grade..... Extra †No. 2
 Per pound..... \$.....
 Three lbs. per cake. One hundred lbs. per case.

ELECTRIC NITRATE SILVER SOLDER.

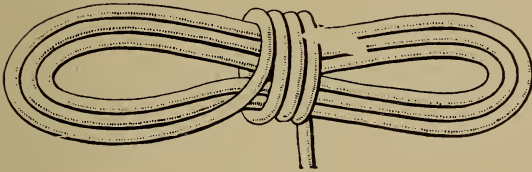

Cut Shows Full Size.

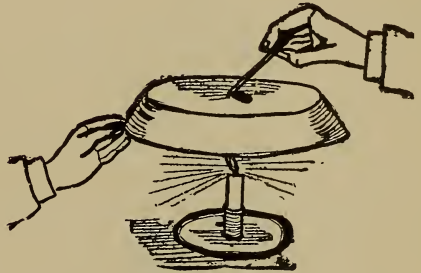

Can be used by any one for repairing Tin, Granite, Aluminum, Copper, etc., without Rosin or Acid. Directions sent with each bunch.

Code Fistelman
 Per bunch..... \$0.10
 Weight per box, lbs..... 3 1/2

One hundred bunches in a box.

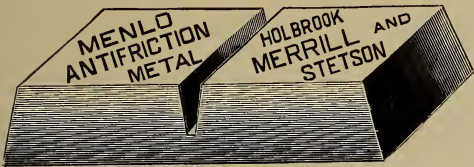

† **MENLO ANTI-FRICTION METAL.**

STRICTLY HIGH GRADE. SUPERIOR TO THE BEST. FOR LIGHT OR HEAVY BEARINGS.

Code..... Fistenros
 Per pound..... \$.....
 About five pounds per cake. Fifty-six pounds in a case.



† **MENLO BABBITT METAL.**

Code Fisteolite Fistercin Fistoram Fisticera
 Grade, numbers... 1 2 3 4
 Per pound..... \$.....
 About fifty pounds in a box.

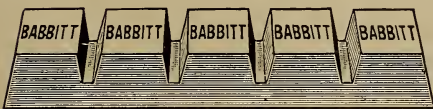

† **GENUINE BABBITT METAL.**

Code Fistiteram
 Per pound..... \$.....

About fifty pounds in a box.

† Carried in San Francisco only.

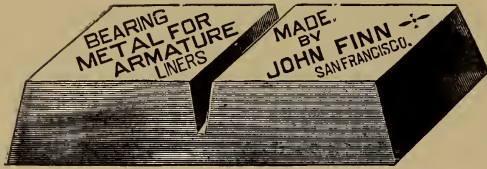

† **FINN'S ARMATURE METAL.**

FOR DYNAMOS, MOTORS, ELECTRIC CRANES, ETC

Code..... Fistoide
 Per pound..... \$.....
 About fifty pounds in a box.



† **MURIATIC ACID.**

RAW. COMMERCIAL.

Code.....	Fistularem	Fitacione
Package.....	Bottles	Carboys
Capacity, gallons	½	8
Pounds of acid	6	100
Per pound.....	\$.....

Shipping weight of carboys about 120 pounds.

COOKED.

Code..... Fitadeller
 One pint bottles, each..... \$.....

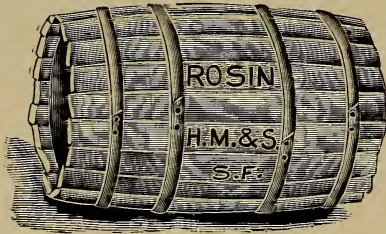

† **ROSIN.**

BEST QUALITY.

Code.....	Fitadore	Fitament	Fitantibo	Fitaredon
Boxes, lbs.....	10	15	25	Bbl., lbs., 300
Per pound	\$.....



† **SOLDERING SALTS.**

Code..... Fitaristic
 Per dozen bottles..... \$.....

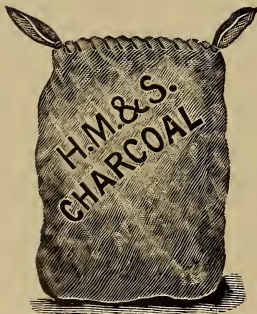

CHARCOAL.

EXTRA QUALITY.

Code..... Fitorum
 Per sack..... \$.....

About fifty pounds in a sack.

† Carried in San Francisco only.

† **ASBESTOS CORRUGATED PAPER.**

COVERING FOR HOT-AIR FURNACE PIPES AND HEATERS.

This Covering is made by cementing a flat and corrugated piece of Sheathing together, thereby producing Dead Air Spaces. Thirty-six inches wide.

Code	Fitatorino
Thickness, inches.....	$\frac{1}{4}$
Square feet in a roll.....	250
Weight per square foot, ounces.....	$4\frac{1}{3}$
Per square foot.....	\$0.04

About seventy-five pounds in a roll.

ASBESTOS PAPER OR SHEATHING.

This is a Fire-Proof Sheathing or Lining for wrapping hot-air furnace pipes, etc. It will not disintegrate with age, is odorless and vermin-proof. Thirty-six inches wide.

Code.....	Fitatoripa	Fitatoritt	Fitatorive
Thickness.....	Thin	Medium	Heavy
Weight per 100 square feet, lbs.....	6	10	14
Square feet in a roll.....	1300 to 1600	800 to 1000	500 to 700
Per pound.....	\$0.08	.08	.08

About one hundred pounds in a roll.

† **ASBESTOS ROLL MILL BOARD.**

Composed of Fibrous Asbestos, taking the place of Asbestos Sheathing where a heavier material is desired. Thirty-six inches wide.

Code	Fitatorobe	Fitatorock	Fitatoroed
Thickness, inches.....	$\frac{3}{32}$	$\frac{1}{16}$	$\frac{1}{8}$
Weight per 100 square feet, lbs.....	16	35	65
Per pound.....	\$0.10	.10	.10

About one hundred pounds in a roll.

† **ASBESTOS SHEET MILL BOARD.**

Is fire and acid-proof, and is valuable for packing joints in contact with fire and oils. It is also used for Fire Screens, Partitions, Ceilings and Linings for Ranges, Stoves, Grates, Gas Backs, etc. In sheets 40 x 40 inches.

Code	Fitatoroft	Fitatorogo	Fitatorolp	Fitatosab	Fitatosado	Fitatoseem	Fitatosege
Thickness, inches.....	$\frac{1}{32}$	$\frac{1}{16}$	$\frac{3}{32}$	$\frac{1}{8}$	$\frac{3}{16}$	$\frac{1}{4}$	$\frac{1}{2}$
Weight per sheet, lbs.....	2 to $2\frac{1}{2}$	$3\frac{3}{4}$ to $4\frac{1}{4}$	$5\frac{1}{2}$ to 6	$7\frac{1}{2}$ to 8	11 $\frac{1}{2}$ to 12	13 $\frac{1}{2}$ to 14 $\frac{1}{2}$	27 to 30
Per pound.....	\$0.10	.10	.10	.10	.10	.10	.10

About four hundred pounds in a case.

† **ASBESTOS WICK PACKING.**

This Wick Packing is composed of selected Asbestos Fibre spun into strands (which can be separated) and made into the form of soft, strong "Lamp-wick," which may be wound or packed around small valve stems, pumps, etc. It is acid and fire-proof. Wound in balls.

Code	Fitatosef	Fitatosegi	Fitatoseht	Fitatosell	Fitatosick	Fitatoship
Diameter, inches.....	$\frac{1}{8}$	$\frac{1}{8}$	$\frac{1}{8}$	$\frac{1}{4}$	$\frac{1}{4}$	$\frac{1}{4}$
Weight of balls, lbs.....	$\frac{1}{4}$	$\frac{1}{2}$	1	$\frac{1}{4}$	$\frac{1}{2}$	1
Per pound.....	\$0.30	.30	.30	.30	.30	.30

One-half pound balls always sent unless otherwise ordered.

State if $\frac{1}{8}$ or $\frac{1}{4}$ inch is wanted.

† Carried in San Francisco only.

PORCELA.

FOR CLEANING AND POLISHING PORCELAIN ENAMELED PLUMBING FIXTURES. ALSO KITCHEN UTENSILS AND WARE.

Guaranteed to remove dirt, grease, rust, lime and other stains from porcelain enameled ware without harm to the glazed surface or injury to the hands.

Code.....	Gocabone
Size, ounces.....	8
Per dozen	\$2.40
Weight per dozen, lbs.....	6
Weight per case, lbs.....	100

One gross in a case.

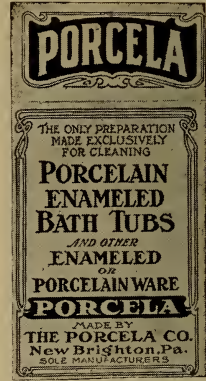

PEERLESS IRON ENAMEL.

JET BLACK. WITH BRISTLE BRUSH.

For general use on Registers, Grates, Fenders, Stovepipes, Coal Hods, Carriage Tops, etc.

Code.....	Goarined
Size of cans, pint.....	1/2
Per dozen.....	\$3.00
Weight per case, lbs.....	12
Shipping measurement per case, cubic feet.....	5 1/2

One dozen in a case.



† **BLACK VARNISH.**

BEST GRADE ASPHALTUM.

Code.....	Goatman
Per gallon	\$2.50
Weight per gallon, lbs.....	8

† Carried in San Francisco only.





“PEERLESS” ALUMINUM ENAMEL.

HIGHEST GRADE MADE.

Can be used on any surface. Will give a bright enamel finish with frosted silver effect.

Code	Goaventure	Gobadill
Pint.....	$\frac{1}{4}$	† 1
Per dozen.....	\$4.00	13.00
Weight per case, lbs.....	17 $\frac{1}{2}$	17 $\frac{1}{2}$
Shipping measurement per case, cu. ft.	$\frac{7}{12}$	$\frac{7}{12}$

$\frac{1}{4}$ -pint cans, three dozen in a case.
1-pint cans, one dozen in a case.



† **WHITE ENAMEL PAINT.**

BEST QUALITY.

Applied to any surface with satisfactory results.

Code	Gobalico	Gobament	Gobarrona
Size of cans	$\frac{1}{2}$ pt.	1 pt.	1 qt.
Per dozen.....	\$6.00	10.00	19.20
Weight per dozen, lbs.....

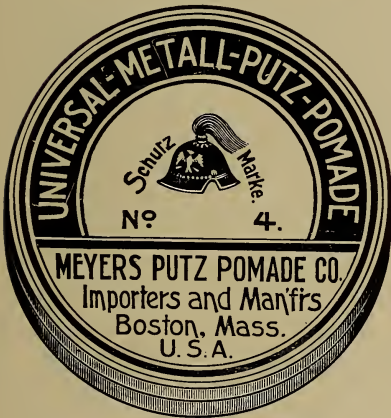

† **UNIVERSAL METAL PUTZ.**

GENUINE RED PASTE POLISH. HELMET AND FLOWING PLUME BRAND.

This paste will not shrink, or lose its polishing or cleaning qualities with age.

Code.....	Gobaticos	Gobillo	Gobinate
Size, lbs.....	1	2 $\frac{1}{2}$	5
Per pound.....	\$0.33	.30	.30

1-pound tins packed six dozen in a case.



† **MEYERS' PUTZ EXTRACT.**

A CREAM-COLORED PASTE.

For cleaning and polishing Gold, Silver, Brass, Copper and all metals.

This cream is made from the highest grade oils, and is positively superior to any known paste polish. It is free from grit, mercury or acid.

Code	Gobitone	Gobstuck
Numbers	4	16
Size.....	3 oz.	1 lb.
Per dozen.....	\$1.30	6.00

3-ounce, one gross in a case; weight, 34 pounds.
1-pound, one-quarter gross in a case; weight, 44 pounds.

† Carried in San Francisco only.



† **MEYERS' PUTZ LIQUID.**

A RED LIQUID POLISH.

Code	Gocadino
Size of cans, pint.....	½
Per dozen	\$3.00
Weight per case, lbs.....	30
Three dozen in a case.	



† **"SUNSHINE" METAL POLISH.**

LIQUID. HIGH GRADE.

Code	Gocardare_Gocaroned
Size of cans, pint.....	½ 1
Per dozen	\$2.40 4.20
Weight per case, lbs.....	11 18
Shipping measurement per case,	
cu. ft.....	⅓ ⅔
One dozen in a case.	



† **THREE IN ONE.**

CLEANS AND POLISHES. PREVENTS RUST. LUBRICATES.

For Typewriters, Bicycles, Guns, Sewing Machines, Talking Machines, Razors and Strops.

Code.....		
Size.....	Small	Large
Per dozen.....	\$1.20	3.00
Weight per box, lbs.....	7	7
Shipping weight, per box, cubic feet.....	⅓	⅓

Small, two dozen in a box.

Large, one dozen in a box.

† Carried in San Francisco only.



PIPE JOINT PASTE.

NON-CORROSIVE.

Makes absolutely **Air-Tight Pipe Joints**, and will resist the action of **Water, Heat, Cold, Acids**, etc.

Code.....
Size of cans, lbs.....	5	10	25
Per pound	\$0.25	.25	.25

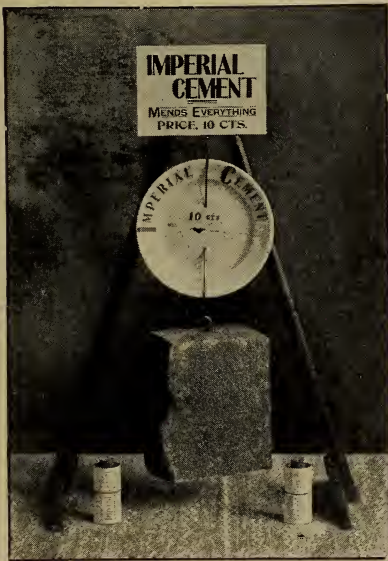

IMPERIAL CEMENT.

THE BEST CEMENT MADE.

For Mending Ornaments—Wood, Leather, China, Glass, Ornamental Dishes, Bric-a-brac, etc.

Can stand a strain of 300 pounds.

Put up in one ounce bottles.

Code
Per dozen.....	\$1.20
Weight per dozen, lbs.....	2¼

One dozen in a box.

A handsome display stand, as shown in cut, is furnished with each first order.

“BRILLIANTSHINE.”

IN LIQUID FORM



GALLON.

HALF GALLON.

QUART.

PINT.

HALF PINT.

Code.....	Gocatema	Goccador	Goccalepe	Goccalint	Goccapart
Numbers	2	3	4	5	6
Size.....	½ pt.	1 pt.	1 qt.	½ gal.	1 gal.
Per dozen...	\$1.80	3.40	6.20	12.00	20.40
Case lots, doz.....	3	2	1	½	½
Weight per case, lbs.....	29 ½	32	30	30	54
Shipping measurement per case, cubic feet.....	1 ½	1	1	1	1 ½

† “BRILLIANTSHINE.”

IN PASTE FORM.

WILL POLISH EITHER HOT OR COLD METALS.

Code.....	Gocchidur	Gocchori	Goccland	Gocclares
Numbers.....	7	8	9	10
Size.....	2 oz.	5 oz.	1 lb.	5 lb.
Per dozen	\$1.00	2.00	4.00	20.40
Case lots, doz.....	12	6	2	½
Weight per case, lbs	35	40	34	38
Ship. meas. per case, cu. ft.	¾	1 ½	¾	1



“CLIMAX” BAR POLISH.

POWDERED FORM. USED WITH WATER.

Code.....	Gochabamo
Number	12
Size	1 lb.
Per dozen	\$2.40
Case lots, doz.....	3
Weight per case, lbs.....	38
Shipping measurement per case, cubic feet.....	1 ¼

† Carried in San Francisco only.

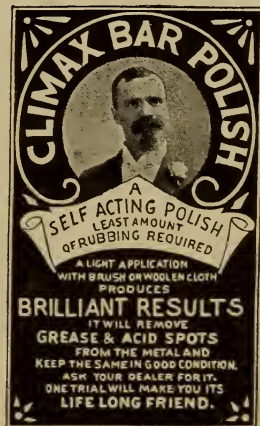

† **COMPETITION RUBBER HOSE.**

A CHEAP GRADE. NOT GUARANTEED. SEAMLESS TUBE.

Code.....	Kerklite	Kerkpile	
Inch.....	½	¾	
Per foot (3-ply).....	\$0.05¾	.06½	



† **“PIONEER” RUBBER HOSE.**

FOR ORDINARY USE. NOT GUARANTEED. SEAMLESS TUBE.

Code.....	Kerktor	Kerkwage	Kermass
Inch.....	½	¾	1
Per foot (3-ply).....	\$0.09	.10	.15



† **“ELK” RUBBER HOSE.**

A GOOD QUALITY. SEAMLESS TUBE.

Code.....	Kermisap	Kermistar	Kernarde
Inch.....	½	¾	1
Per foot (3-ply).....	\$0.11	.13	.18



† **“TURTLE” RUBBER HOSE.**

WHITE RUBBER COVERED HOSE WITH 5-PLY CANVAS.
FOR HEAVY PRESSURE. SEAMLESS TUBE.

Code.....	Kernell	Kernerbas	Kernfahl
Inch.....	½	¾	1
Per foot (5-ply).....	\$0.12	.15	.20



† Carried in San Francisco only.

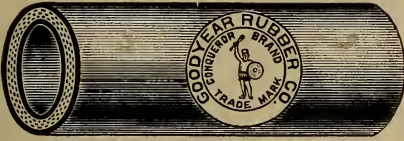

† “CONQUEROR” RUBBER HOSE.

A FINE GRADE. FOR MEDIUM PRESSURE. SEAMLESS TUBE.

Code.....	Kernfrite	Kernholt	Kernmast	Kernober	Kernrub	Kernschut
Inches.....	½	¾	1	1¼	1½	2
Per foot (3-ply).....	\$0.13	.16	.22	.50	.60	.80

† “BADGER” RUBBER HOSE.

WILL STAND HIGH PRESSURE. SEAMLESS TUBE. A HIGH GRADE OF RUBBER HOSE.



Code, 3-ply.....	Kernstat	Kerntrap
Code, 4-ply.....	Kerstbam	Kerstbite
Inch.....	½	¾
Per foot (3-ply).....	\$0.15	.18
Per foot (4-ply).....	.18	.23

Code, 3-ply.....	Kernward	Kersappe	Kersende	Kerseyman
Code, 4-ply.....	Kerstmut	Kerswate	Kerzenrut	Keslope
Inches.....	1	1¼	1½	2
Per foot (3-ply).....	\$0.24	.50	.60	.80
Per foot (4-ply).....	.30	.62	.75	1.00

† “INDIAN” RED RUBBER HOSE.

7-PLY. FINE CANVAS.

RED RUBBER COVER. MADE WITH SEAMLESS TUBE. THE BEST HOSE FOR ORCHARD SPRAYING PURPOSES.



Code	Kesorage	Ketchap	Ketelmar
Inch.....	½	¾	1
Per foot (7-ply).....	\$0.17	.20	.27

Extra charge for Couplings.

† Carried in San Francisco only.

† **“GOLD SEAL” RUBBER HOSE.**

A FIRST-CLASS ARTICLE IN EVERY PARTICULAR.
MADE OF SPECIALLY SELECTED RUBBER
AND CANVAS. SEAMLESS TUBE.

Code (3-ply).....	Keulenar	Keurbend
Code (4-ply).....	Khordate	Khorsaba
Inch.....	½	¾
Per foot (3-ply).....	\$0.19	.23
Per foot (4-ply).....	.23	.29

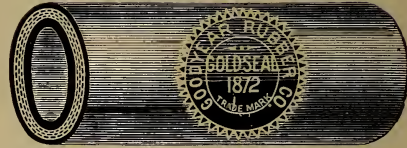

Code (3-ply)	Khaitang	Khandor	Khatuna	Khitmut
Code (4-ply)	Khoteau	Kibatarn	Kibbelar	Kibilk
Inches	1	1¼	1½	2
Per foot (3-ply).....	\$0.30	.50	.60	.80
Per foot (4-ply).....	.38	.62	.75	1.00

† **“PACIFIC” RUBBER HOSE.**

WIRE WRAPPED. WIRE WILL NOT UNCOIL WHEN CUT.

Code	Kicherte	Kiddow
Inch.....	½	¾
Per foot.....	\$0.12	.15

Extra charge for Couplings.



† **“NEPTUNE” COTTON HOSE.**

RUBBER LINED. EXTRA GRADE. SEAMLESS
AND MILDEW-PROOF.

Code	Kidrone	Kiefeke
Inch.....	½	¾
Per foot	\$0.10	.12

In 50-foot lengths, coupling attached.



† **“OBELISK” COTTON HOSE.**

RUBBER LINED. A SUPERIOR GRADE. MILDEW-
PROOF. WARRANTED TO STAND A
HEAVY PRESSURE.

Code.....	Kielhan	Kiekendot
Inch.....	½	¾
Per foot	\$0.13	.15

In 50-foot lengths, couplings attached.

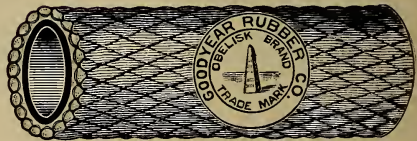

† **“EUREKA” COTTON HOSE.**

RUBBER LINED. SEAMLESS COTTON AND MILDEW-
PROOF. WILL STAND OVER 500 POUNDS
PRESSURE PER SQUARE INCH.

Code	Kiefrost	Kieklot
Inch	½	¾
Per foot.....	\$0.16	.20

In 50-foot lengths, couplings attached.

† Carried in San Francisco only.



HOSE.

Approximate Shipping Weights and Measurements of Rubber Hose per Bale.

Size, inches.....	1/2	3/4	1	1 1/4	1 1/2	2
Number of feet in a bale.....	500	500	500	250	250	100
Shipping measurement per bale, cubic feet.....	2 2/3	6 5/12	8 3/4	6 5/12	8 5/12	4
Competition.....	Weight per bale, lbs.					
Pioneer, 3-ply.....	87	113
Elk, 3-ply.....	103	140	172
Turtle, 5-ply.....	126	177	227
Conqueror, 3-ply.....	110	143	184
Badger, 3-ply.....	127	187	247	167	182	107
Badger, 4-ply.....	134	192	267
Indian, 7-ply.....	162	206	310	208	250	125
Gold Seal, 3-ply.....	133	172	209
Gold Seal, 4-ply.....	130	182	242
Pacific.....	157	202	142	162	182	95
	140	192

Approximate Shipping Weights and Measurements of Cotton Hose per Case.

Size, inch.....	1/2	3/4
Number of feet in a case.....	500	500
Shipping measurement per case, cubic feet.....	7	8 2/3
Neptune.....	Weight per case, lbs.	
Obelisk.....	108	138
Eureka.....	115	157
	129	166

† MEDIUM WHITE RUBBER TUBING.



Code.....	Kielmoss	Kielwald	Kimschot
Inside diameter, inch.....	1/8	3/16	1/4
Per foot.....	\$0.01 1/2	.01 7/8	.02 3/8

Code.....	Kinadrak	Kinamide	Kinawort
Inside diameter, inch.....	5/16	3/8	1/2
Per foot.....	\$0.03	.04	.06

About 50 feet in a box.

HEAVY WHITE RUBBER TUBING.

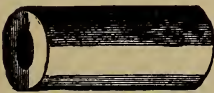

Code.....	Kinband	Kindelbar	Kinderbet
Inside diameter, inch.....	† 3/16	† 1/4	† 5/16
Per foot.....	\$0.03	.04	.06

Code.....	Kinderdop	Kinetick	Kingcrow	Kingfish	Kinkett	Kinkhust
Inside diameter, inch.....	3/8	† 1/2	† 3/8	† 3/4	† 7/8	† 1
Per foot.....	\$0.07 1/2	.10	.13 1/2	.18	.22 1/2	.27

About 50 feet in a box.

† Carried in San Francisco only.

† **PLAIN HOSE PIPES.**

POLISHED CAST BRASS. WITH SCREW TIPS.

Code	Kinobur	Kippent	Kippwag
Inches	$\frac{3}{4}$	1	$1\frac{1}{4}$
Length, inches	8	8	12
Per dozen	\$8.00	10.00	20.00
Weight per doz., lbs.	5	7	14



Code.....	Kircharm	Kirchplan	Kirdolee	Kiretruck
Inches.....	$1\frac{1}{2}$	2	2	2
Length, inches.....	12	12	15	20
Per dozen.....	\$25.00	38.00	45.00	50.00
Weight per doz., lbs.....	16	21

$\frac{3}{4}$ and 1-inch, one dozen in a box. All others loose.

† **C. L. E. HOSE PIPES.**

POLISHED CAST BRASS. WITH SCREW TIPS.

Code	Kirmest	Kirsing	Kistepack
Inches	$\frac{3}{4}$	1	$1\frac{1}{4}$
Length, inches	8	8	12
Per dozen.....	\$13.00	15.00	40.00
Weight per doz., lbs.	8	$9\frac{1}{4}$	30

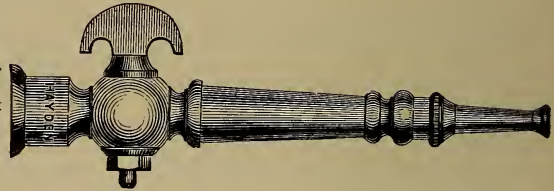

Code.....	Kitchendo	Kittelend	Kitterdek	Klabast	Klacroctor	Klacelling
Inches.....	$1\frac{1}{4}$	$1\frac{1}{2}$	$1\frac{1}{2}$	2	2	2
Length, inches.....	15	12	18	12	15	20
Per dozen.....	\$45.00	55.00	70.00	80.00	95.00	110.00
Weight per doz., lbs.....	35	49	60

$\frac{3}{4}$ and 1-inch, one dozen in a box. All others loose.

† **HOSE PIPE TIPS.**

POLISHED BRASS.

Code	Kladbake
Inch.....	$\frac{3}{8}$
Per dozen.....	\$4.00
Weight per doz., lbs.....	1



One dozen in a package.
Fits $\frac{3}{4}$ and 1-inch hose pipes.

† **HOSE SPRINKLERS.**

POLISHED BRASS. THREADED $\frac{3}{8}$ IN. IRON PIPE.

Code.....	Kladpate	Kladstock	Kladwurm
Diameter, inches.....	2	$2\frac{1}{2}$	3
Per dozen.....	\$4.50	6.00	9.00
Weight per doz., lbs.....	$1\frac{1}{4}$	$1\frac{1}{2}$	3

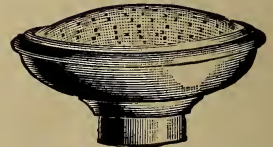

One dozen in a box.
Fits $\frac{3}{4}$ and 1-inch hose pipes.

† Carried in San Francisco only.

† **“MERRILL’S” SPRINKLERS.**



IRON COPPER PLATED.

To Clamp on Tip of $\frac{3}{4}$ or 1-inch Hose Pipe.

Code.....	Klafter
Per dozen	\$4.80
Weight per doz., lbs.....	4
One dozen in a box.	

“MAGIC” SPRAY HOSE PIPES.

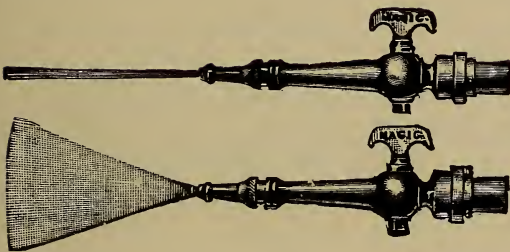

POLISHED BRASS.

Throws either a Straight Stream or a Graduated Spray.

Code	Klagbarn	Klagepund
Inch	$\frac{3}{4}$	† 1
Length, inches.....	5	6 $\frac{3}{4}$
Per dozen.....	\$5.50	12.60
Weight per doz., lbs.....	5 $\frac{1}{2}$	10 $\frac{1}{4}$
One dozen in a box.		

“MYSTIC” SPRAY HOSE PIPES.

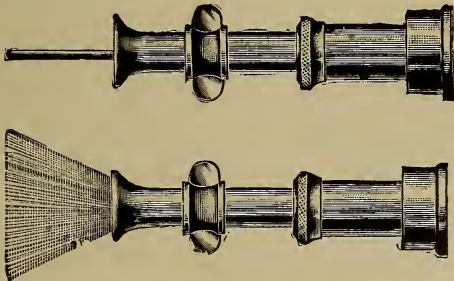

POLISHED BRASS.

Throws a Fine or Coarse Spray or a Solid Stream.

Code.....	Klagesant
Inch.....	$\frac{3}{4}$
Length, inches.....	4 $\frac{5}{8}$
Per dozen.....	\$4.90
Weight per doz., lbs.....	6 $\frac{1}{2}$
One dozen in a box.	

† **“CRESCENT” SPRAY HOSE PIPES.**

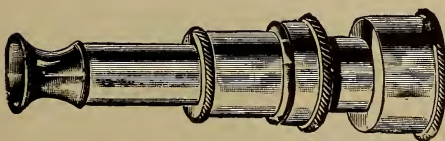

POLISHED BRASS.

Throws a Fine or Coarse Spray or a Solid Stream.

Code.....	Klagetone
Inch.....	$\frac{3}{4}$
Length, inches.....	3 $\frac{5}{8}$
Per dozen.....	\$4.00
Weight per doz., lbs.....	5 $\frac{1}{2}$
One dozen in a box.	

† Carried in San Francisco only.

“GEM” SPRAY HOSE PIPES.

POLISHED BRASS.

Throws a Large or Small Solid Stream, or Coarse or Fine Spray.

Code.....	Klaghund
Inch.....	3/4
Length, inches.....	4 3/8
Per dozen.....	\$5.05
Weight per doz., lbs.....	6
One dozen in a box.	

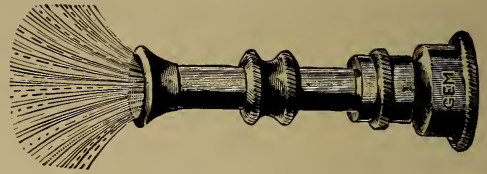

† **“BOSS” HOSE PIPES.**

POLISHED BRASS.

Throws a Spray by a Direct Stream, With no Cone or Groove to retard it, and a Round, Solid Stream by simply turning the Cock.

Code	Klamacht	Klampent
Inch.....	3/4	1
Length, inches.....	3 1/2	3 3/4
Per dozen.....	\$6.30	11.25
Weight per doz., lbs.....	6	7
One dozen in a box.		

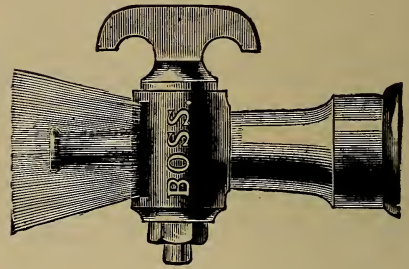

† **“YPSILANTI” COMBINATION HOSE PIPES.**

ROUGH NICKEL-PLATED IRON.

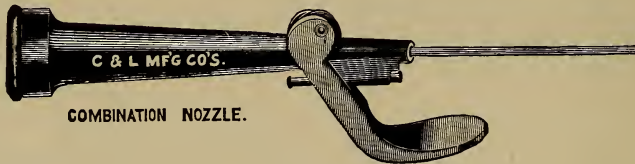

COMBINATION NOZZLE.

Throws Spray or Solid Stream.

Code	Klandist
Inch	3/4
Length, inches.....	5 1/2
Per dozen.....	\$3.30
Weight per doz., lbs.....	7

Loose.

† **IMPROVED BLAKE LAWN SPRINKLERS.**

IRON. COPPER-PLATED. REVOLVING SPOON.

Code.....	Klancolan
Inch.....	3/4
Size, inches.....	4 1/2 x 3 3/4
Per dozen.....	\$4.00
Weight per doz., lbs.....	6
One dozen in a box.	



† Carried in San Francisco only.

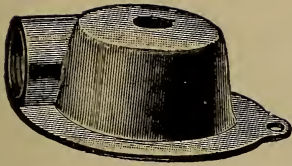

**“C. B. G.” LAWN
SPRINKLERS.**

CHEAP BUT GOOD. IRON. JAPANED BLACK.

Code.....	Klangreed
Inch.....	¾
Per dozen	\$4.50
Weight per doz., lbs.....	13

One-half dozen in a box.

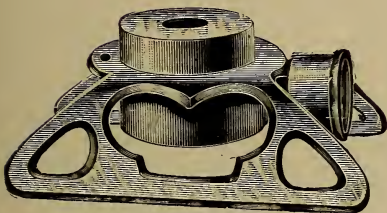

**“EVANSTON” LAWN
SPRINKLERS.**

IRON. JAPANED BLACK.

Code.....	Klangstur
Inch.....	¾
Per dozen	\$6.00
Weight per doz., lbs.....	22

One dozen in a box.

† **“JAPANESE” LAWN
SPRINKLERS.**

IRON FRAME. JAPANED BLACK. POLISHED

BRASS TOP.

This Sprinkler is adjustable so that from any pressure a spray may be obtained as light as steam or as heavy as the area of supply pipe.

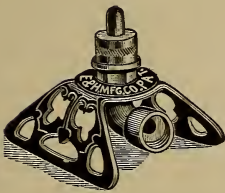

Code.....	Klangwind	Klangmet
Numbers	12	13
Inch.....	¾	1
Per dozen	\$12.00	15.00
Weight per case, lbs.....	33	38

One-twelfth dozen in a box.

One dozen in a case.

† **“WILGUS” LAWN
SPRINKLERS.**

GALVANIZED IRON. WILL DISTRIBUTE AN EVEN SPRAY

30 FEET IN DIAMETER.



Code.....	Klapbord
Inch.....	¾
Per dozen	\$4.30
Weight per doz., lbs.....	13

One-half dozen in a box.

† Carried in San Francisco only.

† **“WILCUS” FOUNTAIN LAWN SPRINKLERS.**

GALVANIZED IRON. HAS FOUNTAIN IN CENTER OF SPRAY.

Code.....	Klaploop
Inch.....	$\frac{3}{4}$
Per dozen	\$6.75
Weight per doz., lbs.....	14½

One-half dozen in a box.

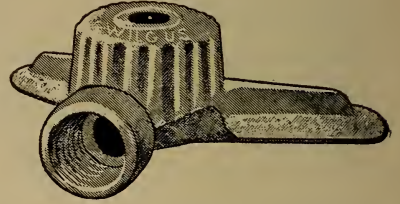

† **“WILCUS” TWIN LAWN SPRINKLERS.**

GALVANIZED IRON. THROWS DOUBLE CIRCLE SPRAY.

Code.....	Klaplune
Inch.....	$\frac{3}{4}$
Per dozen.....	\$5.50
Weight per doz., lbs.....	7¾

One-half dozen in a box.

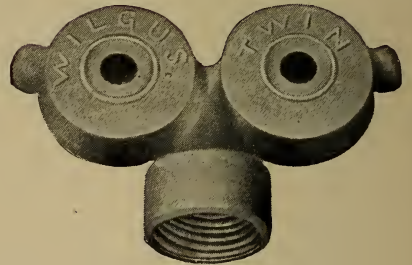

“BUSY” LAWN SPRINKLERS.

CONSISTS OF A BLAKE SPRINKLER ATTACHED TO A SLED BASE.

Code.....	Klapmast
Inch.....	$\frac{3}{4}$
Base, inches.....	$7\frac{3}{4} \times 6\frac{1}{2}$
Height, inches.....	7
Per dozen	\$9.60
Weight per doz., lbs.....	27

One-twelfth dozen in a box.

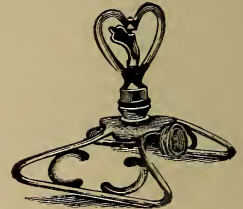

† **“FAN” LAWN SPRINKLERS.**

IRON. NICKEL-PLATED.

Code.....	Klapptick
Inch.....	$\frac{3}{4}$
Per dozen	\$3.00
Weight per doz., lbs.....	8

One dozen in a box.

† Carried in San Francisco only.

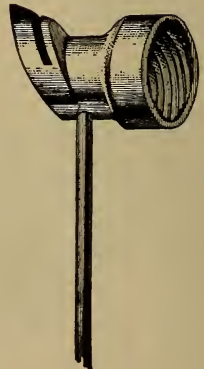

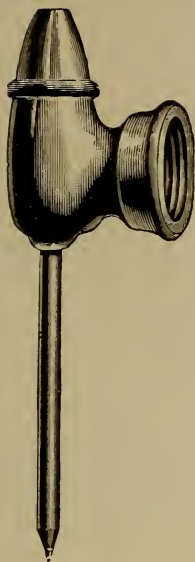

† **“ECLIPSE” LAWN SPRINKLERS.**

IRON. JAPPANED VERMILION. SPUN COPPER TOP.
COVERS 36 FEET IN DIAMETER.

Code.....	Klaprote
Inch.....	¾
Per dozen	\$1.80
Weight per doz., lbs.....	3¼

One dozen in a box.

† **“WATER WITCH” LAWN SPRINKLERS.**

POLISHED BRASS NICKEL-PLATED

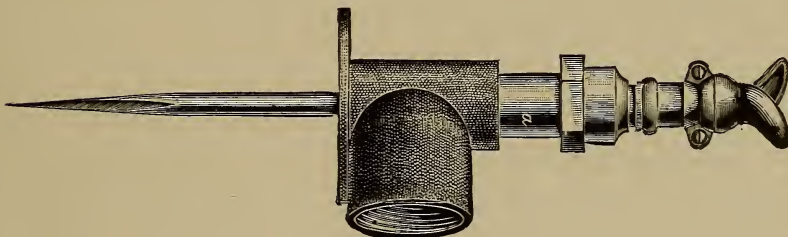

Cut shows Style No. 3.

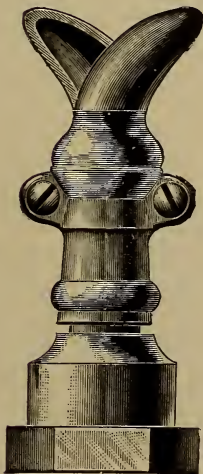

Cut shows Style No. 1.

Code.....	Klapwand	Klarette	Klassick
Numbers	01	1	3
Per dozen	\$4.50	4.15	6.00
Weight per doz., lbs.....	1½	1½	8

One-half dozen in a box.

No. 01 has ⅛-inch hole and ⅜-inch iron pipe thread.

No. 1 has ¼-inch hole and ⅜-inch iron pipe thread.

No. 3 has ¼-inch hole and ¾-inch hose thread.

† Carried in San Francisco only.

† **“O’SHEA” LAWN
SPRINKLERS.**

TO BE USED WITH TRIPOD HOSE HOLDER. WILL
THROW WATER OVER A SPACE 30 TO
50 FEET IN DIAMETER.

Code.....	Klaterin	Klaudet	Klausnet
Numbers	1	3	4
Arms.....	2	2	4
Arms, inches.....	$\frac{3}{8}$	$\frac{3}{8}$	$\frac{3}{8}$
Inch.....	$\frac{3}{4}$	1	$\frac{3}{4}$
Per dozen	\$15.00	18.00	21.00
Weight per doz., lbs.....	15	16½	21



† **“TRIPOD” HOSE HOLDER
OR STAND.**

IRON. PAINTED GREEN.

A simple contrivance for holding the hose. Pass the hose up through the Holder and then screw the sprinkler on the end of the hose.

Code.....	Klaverz
Height, inches.....
Per dozen	\$15.00
Weight per doz., lbs.....

For $\frac{3}{4}$ or 1-inch hose.

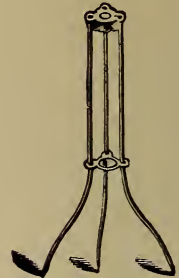

† **“SUNSHINE” LAWN
SPRINKLERS.**

BALL-BEARING. STANDARD, BASE AND LEGS JAPANNED
RED. ARMS POLISHED BRASS.

Code.....	Klaviate
Inch.....	$\frac{3}{4}$
Height, inches.....	13
Per dozen	\$13.50
Weight per doz., lbs.....	37½

One in a box.

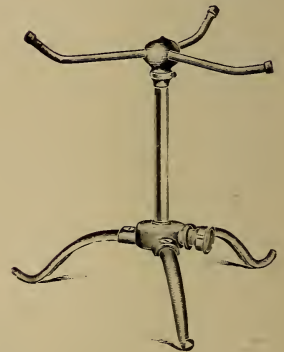

**“PLUVIUS” LAWN
SPRINKLERS.**

SAME AS THE SUNSHINE, EXCEPT IT HAS SLED BASE.

Code.....	Klawhamer
Inch.....	$\frac{3}{4}$
Height, inches	13
Per dozen	\$13.50
Weight per doz., lbs.....	38

One in a box.

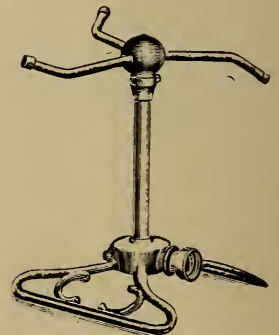

† Carried in San Francisco only.

RUBBER HOSE WASHERS.

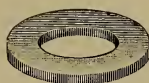

Code.....	Klebestoll	Klebit	Kleedstop	Kleerbote	Kleidest
Inches.....	$\frac{3}{4}$	1	$\dagger 1\frac{1}{4}$	$\dagger 1\frac{1}{2}$	$\dagger 2$
No. washers to lb.	280	240	50	38
Per gross.....	\$0.36	.63	1.62	2.52	3.96
Per lb. in lots of 5 lbs.....					\$0.48

One pound in a box.

HOSE COUPLINGS.



ROUGH BRASS. FOR WATER HOSE.

Code	Kleimerk	Kleinbaum	Kleinholt
Inch.....	$\frac{1}{2}$	$\frac{3}{4}$	1
Per dozen.....	\$2.40	2.40	4.40
Weight per doz., lbs.....	3	$3\frac{1}{2}$	6

Code.....	Kleinlove	Kleinkrat	Kleinmand	Kleinsmot
Inches.....	$\dagger 1 \times \frac{3}{4}$	1 $\frac{1}{4}$	1 $\frac{1}{2}$	2
Per dozen.....	\$4.40	10.00	14.00	24.00
Weight per doz., lbs.....	$6\frac{1}{2}$	11	18	27

For either part of coupling two-thirds above list.

One dozen in a package.

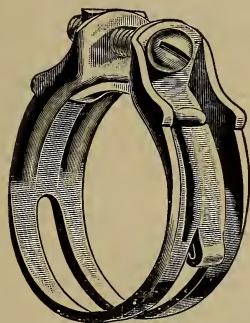

†“SHERMAN” HOSE CLAMPS.

FINISHED BRASS. CAN BE APPLIED WHEN THE COUPLING IS IN THE HOSE. FOR WATER HOSE.

Code	Kleinwast	Kleipide	Kleistrik	Klemhake
Inch	$\frac{1}{2}$	$\frac{3}{4}$	$\frac{3}{4}$	1
Ply.....	3	3	4	3
Diam.open, inches	$1\frac{1}{2} \times \frac{1}{6}$	$1\frac{3}{4} \times \frac{1}{6}$	$1\frac{1}{4}$	$1\frac{1}{2} \times \frac{1}{6}$
Per dozen.....	\$0.36	.36	.36	.99
Wt. per doz., lbs...	$\frac{1}{2}$	$\frac{1}{2}$	$\frac{1}{2}$	$\frac{3}{4}$

$\frac{1}{2}$ and $\frac{3}{4}$ inch, six dozen in a box.
1-inch, three dozen in a box.

†“SHERMAN” DOUBLE HOSE CLAMPS.

The cut shows the use of the Double Clamp in connection with the Sherman mender tube as they are applied in repairing hose. Only one bolt to screw up, and the hose is mended.

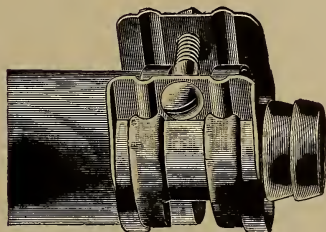

Code.....	Klemintena	Klemkall
For hose, inch.....	$\frac{1}{2}$	$\frac{1}{2}$
Per dozen.....	\$0.72	.72
Weight per doz., lbs.....	$\frac{3}{4}$	1

Six dozen in a box.

† Carried in San Francisco only.

† **SCREW HOSE CLAMPS.**

WROUGHT BRASS.

Code.....	Klenzer	Klepschur	Klerkam	Kletter
Inches	½	¾	1	1¼
Per dozen.....	\$1.50	1.50	2.00	2.50
Weight per doz., lbs	1	1½	2	2

Code.....	Kleurder	Kleurprot	Klimate	Klimboost
Inches.....	1½	2	2½	3
Per dozen.....	\$3.00	4.00	7.00	10.00
Weight per doz.,lbs	3	6	6

Loose.



“**MAGIC**” **HOSE CLAMPS.**

BRASS WIRE. STEEL PINS. FOR EITHER 3 OR 4-PLY HOSE.

Code.....	Klimopher	Klimstun	Klingstat
Inch.....	½	¾	1
Per gross.....	\$3.00	3.00	3.00
Weight per gross, lbs.....	3	3¼	3½

One-half gross in a box.

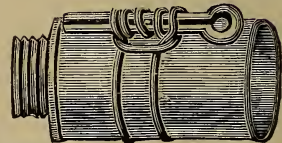
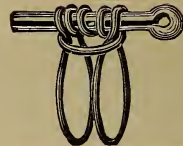

“**CALDWELL’S**” **HOSE STRAPS.**

BRASS WIRE. FOR FASTENING COUPLINGS IN HOSE.

Code.....	Klinkart	Klipatig	Klobiter	Klonasse	Klofris
Numbers....	4	6	8	10	† 12
Inch.....	½	¾	¾	1	1
Length, inches	3¾	4½	4¾	5	5¾
Ply.....	3	3	4	3	4
Per gross...	\$0.90	.90	.90	1.98	1.98
Wt. per gross, lbs	¼	¼	1¼	¾	½

One gross in a package.

† Pliers for attaching Caldwell’s Straps, per dozen \$1.80



Cut shows Strap.



Cut shows Pliers.

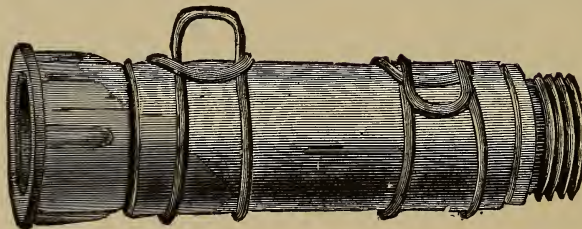

Cut shows “Caldwell’s” Hose Straps applied.

† “**BIG SIX**” **HOSE PATCHES.**

FOR MENDING LEAKY HOSE. SOFT BRASS.

Code.....	Klopget	Klosbeit	Klostera
Inch.....	½	¾	1
Per dozen, with pincers.....	\$0.75	1.00	1.25
Weight per doz., lbs.....	¾	1	1¼

One dozen in a box.

Each box contains a pair of pincers used in applying patch.

† Carried in San Francisco only.





† **“SHERMAN” MENDER TUBES.**

WROUGHT BRASS. SEAMLESS.

Code.....	Klotenrad	Klotzbet	Klovener
Inch.....	½	¾	1
Per dozen.....	\$0.36	.36	.36
Weight per doz., lbs.....	½	⅝	1½

Twelve dozen in a box.

HALL'S HOSE MENDERS.



CAST IRON.

Code.....	Kluchtel	Klufiting	Kluisrolle	Kluizend
Inches.....	½	¾	†1	†1¼
Per dozen.....	\$0.54	.60	1.17	1.80
Weight per doz., lbs..	1¾	2	3¾

One dozen in a box.

† **COMMON HOSE MENDERS.**



CAST IRON.

Code.....	Klumpfut	Klutside	Knabble
Inch.....	½	¾	1
Per dozen.....	\$0.54	.59	1.17
Weight per doz., lbs.....	1½	1¾	3¼

One dozen in a box.

“WOODEN” HOSE MENDERS.



Code.....	Knaben	Knacker
Inch.....	½	¾
Per dozen.....	\$0.11	.11
Weight per doz., lbs.....	¼	⅜

Twelve dozen in a box.

† **COOPER HOSE MENDERS.**

A seamless brass tube. No wires, pliers or mechanical skill required to adjust them. Will not rust and can be used many times.



Code	Knadandy	Knafittum	Knagrunt
Size, inch.....	½	¾	1
Per gross.....	\$9.00	9.00	10.20

Three dozen in a box.

‡ Carried in Los Angeles only.

HOSE BUSHINGS.

CAST BRASS.

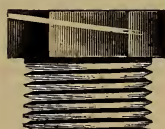

Code.....	Knabstet	Knappend	Knaptort	Knarrow
Inches.....	1x¾	1¼x1	1½x1¼	†2x1½
Per dozen.....	\$6.50	10.00	12.00	18.00
Weight per doz., lbs.	2	3	5	7

One dozen in a package.

† Carried in San Francisco only.

HOSE REDUCERS.

CAST BRASS.

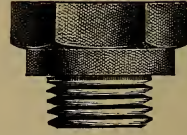

Code.....	Knatters	Knausing
Inches.....	1x¾	1¼x¾
Per dozen.....	\$6.50	10.00
Weight per doz., lbs.....	2	3

Code.....	Knauter	Knaving	Knavish	Kneader	Kneambus	Knebelt	Kneedful
Inches.....	1¼x1	1½x¾	1½x1	1½x1¼	2x1	2x1¼	2x1½
Per dozen.....	\$10.00	12.00	12.00	12.00	18.00	18.00	18.00
Weight per doz., lbs.....	3	3	4	5	8¼	6	7

One dozen in a package.

HOSE NIPPLES.

CAST BRASS.

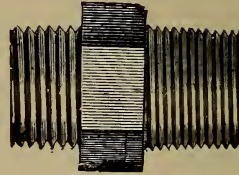

Code.....	Kneedster	Kneepant
Inch.....	†½	¾
Per dozen.....	\$3.50	3.50
Weight per doz., lbs.....	2	2½

Code.....	Kneipor	Knetbart	Knetmile	Knetwork
Inches.....	1	†1¼	†1½	†2
Per dozen.....	\$5.00	9.00	10.00	14.00
Weight per doz., lbs.....	3¼	6	8	9

One dozen in a package.

† HOSE BIBB ENDS.

CAST BRASS.

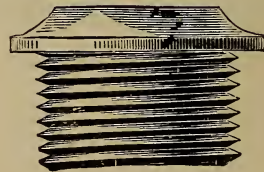

Code.....	Kneuter	Knicker
Inch.....	½	⅝
Per dozen.....	\$2.50	2.50

Code.....	Knickwell	Knielar	Knievorm	Kniffel
Inches.....	¾	1	1¼	1½
Per dozen.....	\$2.50	3.50	6.00	8.00

One dozen in a package.

† Carried in San Francisco only.

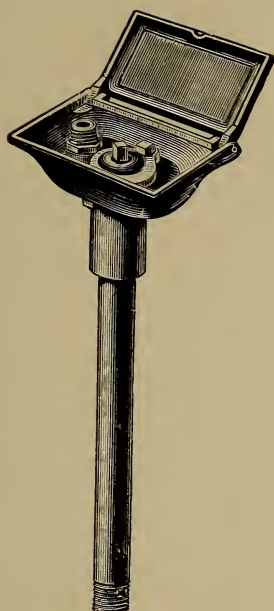

† **CALIFORNIA STREET WASHERS.**

FOR SPRINKLING OR IRRIGATING PURPOSES. IN NON-FREEZING CLIMATES. COMPRESSION BRASS VALVES. HEAVY CAST IRON BOX, JAPANED. WROUGHT IRON GALVANIZED PIPES.

To set in ground 1½ feet.

Code.....	Knipbeer	Kniperst	Kniplute	Knipole
Inches	¾	1	1¼	1½
Each	\$3.50	4.00	5.00	7.50
Weight each, lbs	10	10½

Each Washer has a key.

CHICAGO GOOSE NECK CONNECTIONS.

MADE OF BRASS.

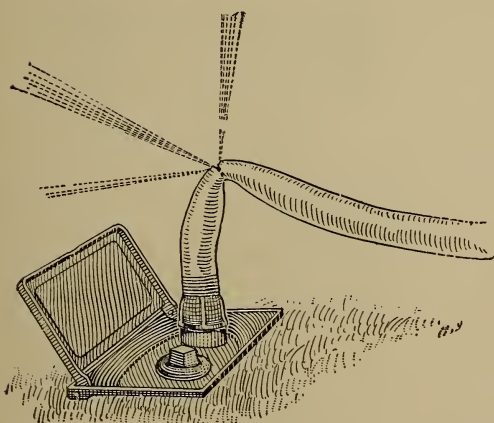

The Old Way.

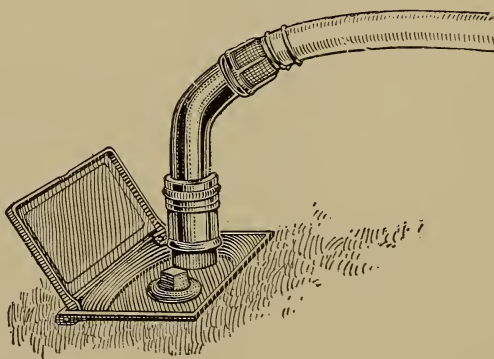

With Chicago Goose Neck.

Code.....	Knipster
Inch.....	¾
Per dozen.....	\$6 75
Weight per doz., lbs.....	6

One dozen in a box.

† Carried in San Francisco only.

PERFECTION BUGGY WASHERS.

FOR WASHING BUGGIES, AUTOMOBILES, ETC.
 BALL BEARING JOINTS. ARM 4½ FEET
 LONG. THREADED ¾-INCH IRON
 PIPE, WITH ¾-INCH HOSE
 COUPLING.

Code.....	Knipull
Number	1
Each.....	\$24.00
Weight each packed, lbs.....	11
One in a box.	



Reaches vehicle from all sides.
 No heavy hose to drag.
 No vehicle to move.

WRITE FOR DESCRIPTIVE
 CIRCULAR AND PRICES.

†HOWARD HOSE RACK WITH WALL PLATE.

IRON. FINISHED IN GOLD BRONZE.

This rack will hold 50 feet of 1½-inch Unlined Linen Hose. Longer lengths can be placed upon this rack by lengthening the loop, but it will not hold hose larger than 1½ inch.

Code.....	Knisuck
Number	1
Each.....	\$5.00
Weight each, lbs.....	23

Unquestionably the best device on the market for holding hose. The hose can be drawn from the rack by any one without previous drilling and without any possibility of the hose becoming tangled. This is rendered possible by the shedding of the pins from the rack in the removal of the hose.

The above price does not include Hose or Valve.

† Carried in San Francisco only.

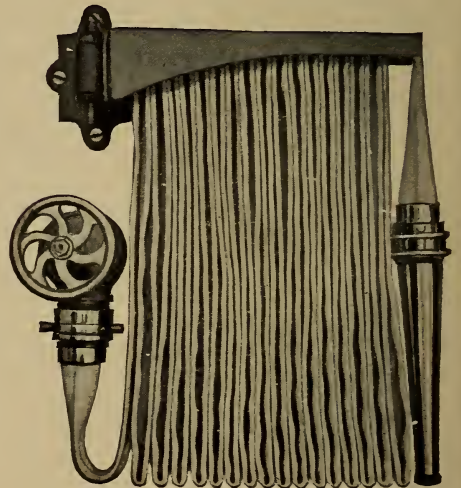

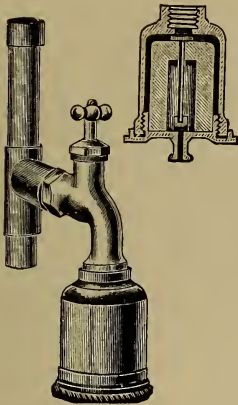

† "CHAMPION" WATER FILTERS.

SAME GENERAL CONSTRUCTION AS No. 2. WITH 3/4-INCH HOSE THREAD, SO THAT FILTER CAN BE ATTACHED TO FAUCET.

Code	Juridium
Number.....	1
Length of tube, inches.....	2 1/2
Diameter of tube, inches.....	2
Capacity per hour, gallons.....	4
Each ...	\$2.50
Weight each, lbs.....	1

One in a box.

† "CHAMPION" WATER FILTERS.

POLISHED BRONZE METAL. NICKEL-PLATED. WITH GERM-PROOF, NATURAL STONE FILTER TUBES.

The Tubes used in the "Champion" Filters are the only perfect filtering material known. Impurities never penetrate their surface. Its pores are naturally disposed so that while water will rapidly percolate through the material all germs, microbes and impurities of every description remain on the surface, from which they can be easily washed by brushing, the stone remaining white and pure. All solid, insoluble matter in the water, whether organic or inorganic, is completely separated, leaving bright, clear, pure water as a filtrate.

The rod which passes through the stone gives it strength and stability. Handsome in appearance and very simple in construction.

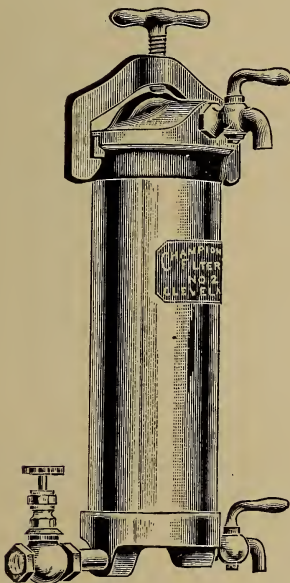

Cut Shows Style No. 2.

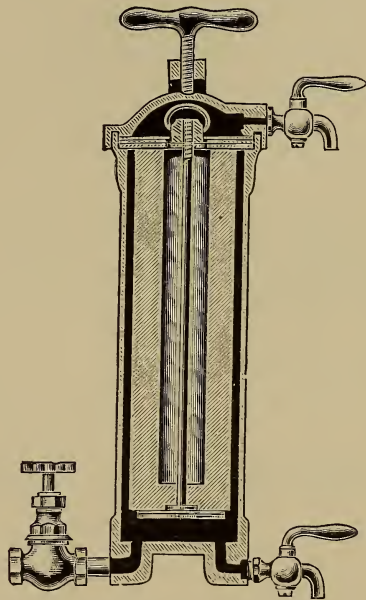

Sectional View.

Code.....	Jurgate
Number	2
Length of stone, inches.....	9
Diameter of stone, inches.....	2 1/2
Capacity per hour, gallons.....	25
Connection iron pipe size, inch.....	1/4
Each	\$15.00
Weight each, lbs.....	9
Shipping measure each, cubic feet.....	1/4

One in a box.

† Carried in San Francisco only.

† **“CHAMPION” WATER FILTERS.**

The best and most convenient Faucet Filter. Does not interfere with the regular use of a faucet. By simply turning the key of special connection, filtered or unfiltered water can be obtained. Made of brass, nickel-plated.

Code.....	Jurhursch
Number.....	7
Length of stone, inches.....	6
Diameter of stone, inches.....	2½
Capacity per hour, gallons.....	6
Each.....	\$7.50
Weight each, lbs.....

One in a box.

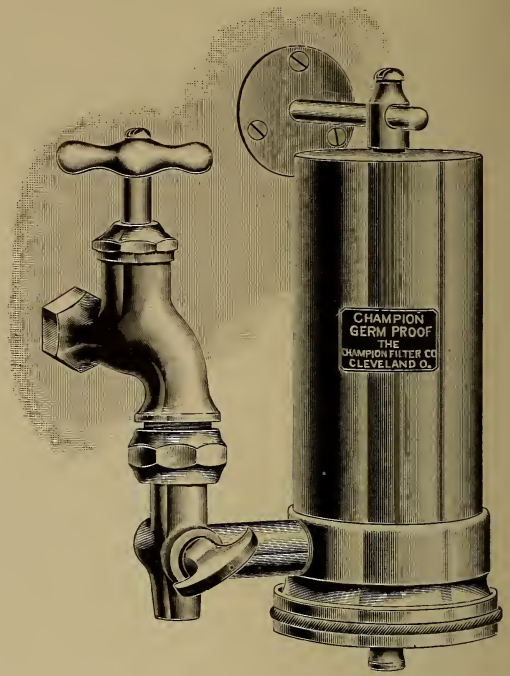

“CHAMPION” WATER FILTERS.

SAME GENERAL CONSTRUCTION AS No. 2 WITH ¾-INCH HOSE THREAD, SO THAT FILTER CAN BE ATTACHED TO FAUCET.

Code.....	Jurigand
Number.....	1½
Length of tube, inches.....	4½
Diameter of tube, inches.....	2⅛
Capacity per hour, gallons.....	8
Each.....	\$3.75
Weight each, lbs.....	1½

One in a box.



† **EXTRAS FOR “CHAMPION” WATER FILTERS.**

Stones.

Code	Jurigette	Jurigole	Jurigust	Jurkwater
Numbers.....	1	1½	2	7
Each	\$0.63	.88	1.88	1.50

Old Style Top Washers.

Code	Jurladie	Jurlidy
Numbers.....	1	2
Each	\$0.10	.20

Old Style Bottom Washers.

Code	Jurmanton	Jurneator
Numbers.....	1	2
Each	\$0.10	.10

† Carried in San Francisco only.

† **“SULTANA” WATER FILTERS.**

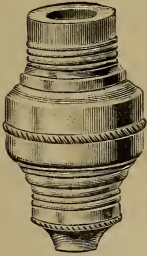

SELF-CLEANING. REVERSIBLE. BRASS. NICKEL-PLATED PERFORATED STRAINERS. FILLED WITH THE BEST FILTERING MATERIAL KNOWN.

Code	Juponder	Juraduro	Juramento
Fits faucets, inch.....	½	⅝	¾
Length, inches.....	3	3	3
Diameter, inches.....	1¼	1¼	1⅞
Per dozen.....	\$3.00	3.00	3.00
Weight per doz., lbs.....	2½	2½	2½

One dozen in a box.

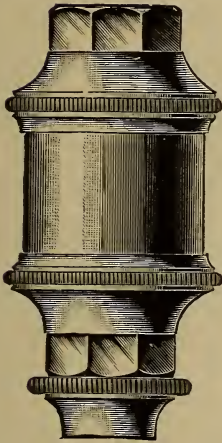

† **WATER FILTERS.**

CAST BRASS. NICKEL-PLATED. REVERSIBLE. ¾-INCH HOSE THREAD.

Code.....	Jurassit
Number.....	1
Length, inches.....	4½
Diameter, inches.....	2½
Per dozen.....	\$17.00
Weight per doz., lbs.....	15

One-half dozen in a box.

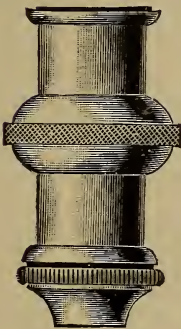

† **WATER FILTERS.**

CAST BRASS. NICKEL-PLATED. REVERSIBLE. ¾-INCH HOSE THREAD.

Code.....	Jurator
Number.....	2
Length, inches.....	3½
Diameter, inches.....	2
Per dozen.....	\$12.00
Weight per doz., lbs.....	7¼

One-half dozen in a box.



† **“CROTON” WATER FILTERS.**

CAST BRASS. NICKEL-PLATED. ¾-INCH HOSE THREAD.

Code.....	Jurensib
Number.....	3
Length, inches.....	2¼
Diameter, inches.....	1½
Per dozen.....	\$6.00
Weight per doz., lbs.....	3

One dozen in a box.

† Carried in San Francisco only.

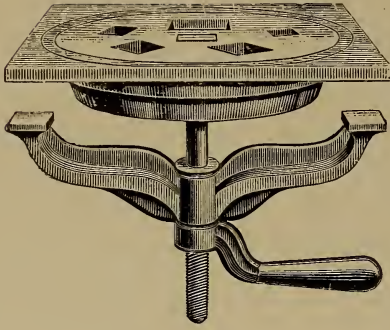

† **IMPROVED BENCH PLATES.**

POLISHED.

This Bench Plate is so made that it can be readily inserted in any bench of ordinary thickness, and revolves so that different tools may be used in the same position.

Code.....	Liquoret
Number.....	3
Inches.....	9x9
Each.....	\$3.50
Weight, lbs.....	18

† **BENCH PLATES.**

CAST IRON. POLISHED.

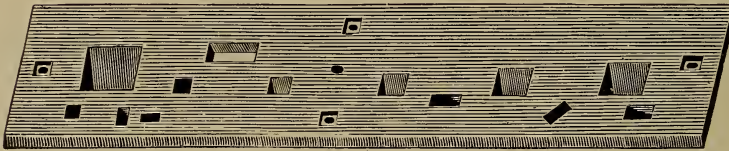

Code.....	Lispelend	Lisstone
Numbers.....	1	2
Inches.....	37x8	30x8
Each.....	\$5.00	3.00
Weight each, lbs.....	50	37

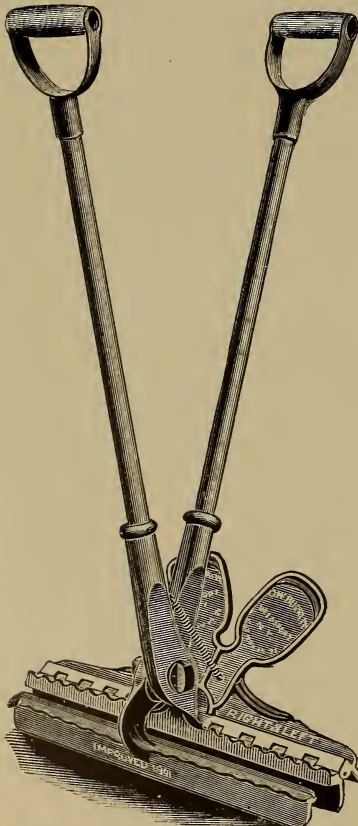

† **BURRITT'S PATENT ROOFING DOUBLE SEAMERS.**

FOR STANDING LOCK TIN ROOFING.

The cut represents the Double Seamer turning over the edge of the metal. The treadle closes down the edge.

We commend these Roofing Double Seamers for Standing Lock, because the work is done more evenly than by any other process. They turn the metal directly over and under, do not crimp the tin, and leave the formed locks of uniform height. They do not deface the surface of the roof; will work well over uneven roof boarding. Will double seam hips and ridges with perfect ease. They can be used by either hand or foot power. They will do the work much faster, easier and better than by hand and mallet. They are simple in construction, durable and not liable to get out of order. When shipped, they are fitted for I. C. Tin.

These Double Seamers are now made and can be furnished adapted to several different styles of Iron Roofing; in fact, for the formation of nearly every style of lock now used in applying sheet metals to roofs.

NOTE.—When ordering Seamers please state whether for common or wide gauge.

Code.....	Listonera	Lithagog
Gauge.....	Common	Wide
Inches.....	1x1 ¼	1 ¼ x1 ½
Per set of 2 pairs.....	\$30.00	30.00
Weight per set, lbs.....	40	40

† Carried in San Francisco only.

† **COMMON ROOFING TONGS.**

STEEL.

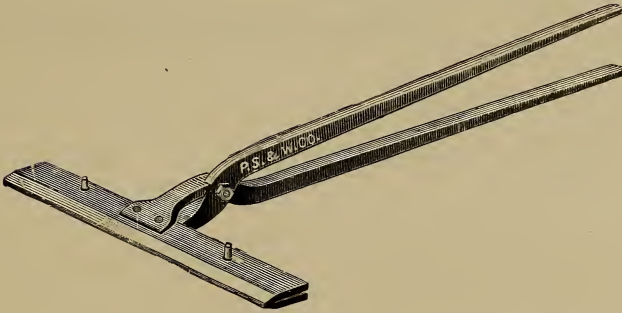

Code	Lithocart	Lithodern	Lithotome	Lithuria	Litigate
Size, inches.....	½	¾	1	1¼	1½
Per pair.....	\$3.00	3.00	3.00	3 00	3.00
Weight, per pair, lbs.....	7½	7½	7½	7½	7½

Two pairs constitute a set.

† **IMPROVED ROOFING TONGS.**

STEEL.

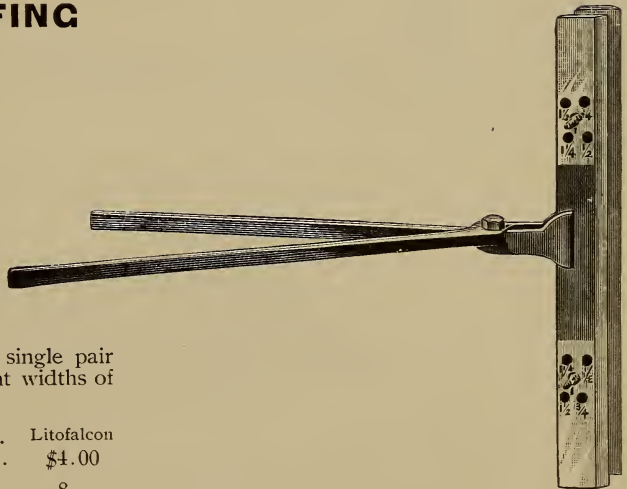

These Tongs are so made that a single pair may be easily adjusted to five different widths of locks, viz.: from ½ to 1½ inches.

Code	Litofalcon
Per pair.....	\$1.00
Weight per pair, lbs.....	8

† Carried in San Francisco only.

† **REESE'S ROOFING TONGS.**

WITH ADJUSTABLE AND REMOVABLE GAUGE.

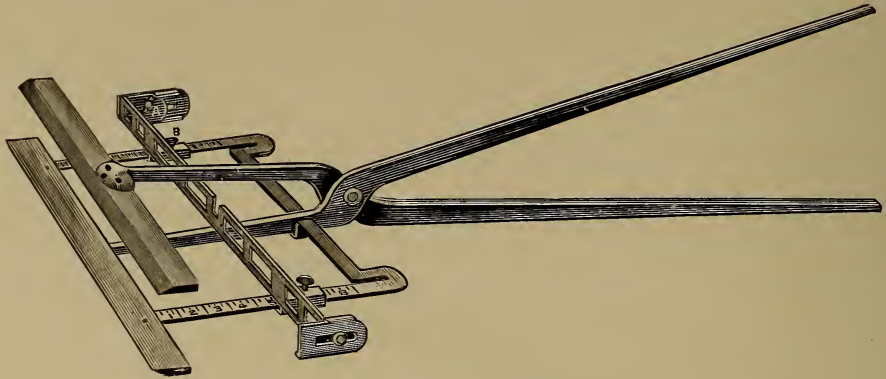

(Patented December, 1884. Improved April, 1899.)

These Tongs will turn any edge from $\frac{3}{4}$ to 10 inches by simply adjusting the thumb screw and sliding the gauge to the desired position. They are adapted to edging and bending all kinds of ordinary sheet metal. They are simple in construction, strong, light and durable. Can be used on No. 22 Iron.

Code.
LitografoWeight each, 11 lbs.....Each, \$8.00

† **GUTTER TONGS.**

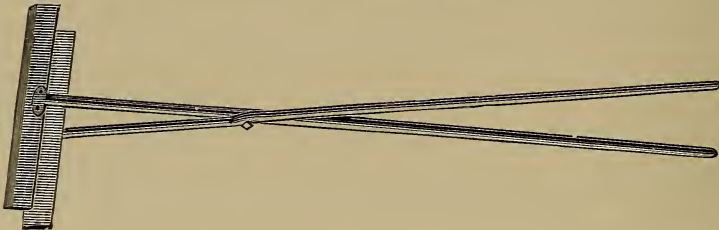

Code.
LitoscopicWeight per pair, ... lbs.....Per pair, \$5.00

† **WOOD ROOFING FOLDERS.**

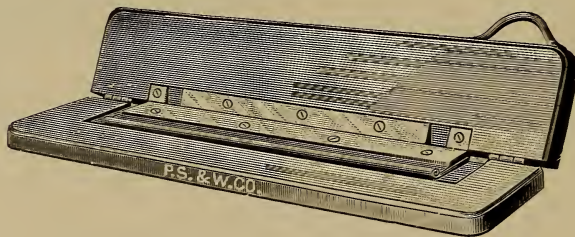

Cut shows Improved Folder, with Gauge.

Code.....	Common.		Improved.	
	Liturando	Livellard	Liventibo	Livron
Inches.....	20	30	20	30
Each.....	\$2.50	3.50	3.50	5.00
Weight each, lbs.....	8	13	8	13

† Carried in San Francisco only.

†**ROOFING DOUBLE SEAMERS.**

TO MATCH ROOFING TONGS.

Code.....	Lixabunt	Loadman	Lobafull	Lobagore
Size, inches.....	¾x1	1x1¼	1¼x1½	Set
Price	\$0.90	.90	.90	1.75
Weight each, lbs..	9	9	9	18

Two pairs constitute a set.

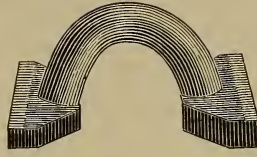

†**A SET OF TINNERS' TOOLS.**

1 Beakhorn Stake, No. 1.....	\$15.00	1 Set Solid Punches, 4 Punches, 2 Chisels	\$0.72
1 Blowhorn Stake.....	5.00	1 Pair No. 4 Bench Shears.....	5.00
1 Creasing Stake.....	4.00	1 Each Raising Hammers, Nos. 1 and 4,	
1 Square Stake.....	3.00	handled.....	3.20
1 Candle Mould Stake.....	2.75	1 Each Setting Hammers, Nos. 2 and 3,	
1 Needle Case Stake.....	2.25	handled.....	1.20
1 Each Hollow Punches, ½, ¾, 1, 1¼,		1 No. 5 Riveting Hammer, handled.....	.38
1½, 1¾ inches.....	5.50		

Packed in one case.

Code.		
Lobberend.....	Weight per case, 165 lbs.....	Per case, \$48.00

†**RING SCRATCH AWLS.**

SOLID STEEL.



Code.	No.	
Lobside.....	1—Length, 8½ inches.	Weight per doz., 1 lb..... Per dozen, \$1.50
		One dozen in a box.

†**SOCKET SCRATCH AWLS.**

FORGED STEEL. POLISHED.



Code.	No.	
Lobulate.....	1—Length of steel, 6 inches.	Weight per doz., 1½ lbs..... Per dozen, \$2.00
		One dozen in a box.

† Carried in San Francisco only.

† **PLAIN SCRATCH AWLS.**

PLAIN BEECH HANDLES.



Code. No.
 Lobward **2**—Length of steel, 5 inches. Weight per doz., 1½ lbs.....Per dozen, **\$1.00**
 One dozen in a box.

† **“HURWOOD” TINNERS’ AWLS.**

EXTRA QUALITY.

WILL NOT BREAK OR TURN ON POINTS. BEST CRUCIBLE $\frac{5}{16}$ -INCH STEEL.

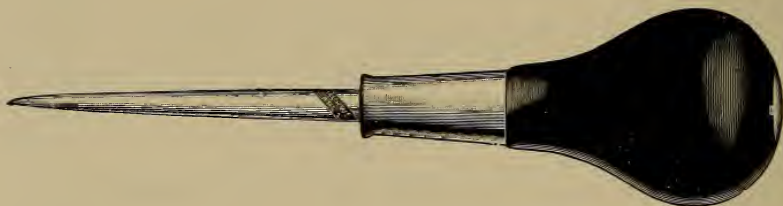

Code.
 Locabiter.....Entire length, 7½ inches; blade, 3¾ inches. Weight per doz., 1½ lbs...Per dozen, **\$4.00**
 One dozen in a box.

† **GASFITTERS’ AUGERS.**

ALL STEEL.



Code.	Localiber	Localized	Locations	Lochbent	Lochome	Lochsage	Locitando
Size of Auger, inches.....	$\frac{3}{4}$	$\frac{7}{8}$	1¼	1½	1¾	2	2½
To cut holes for pipe, inches....	$\frac{3}{8}$	$\frac{1}{2}$	$\frac{3}{4}$	1	$1\frac{1}{4}$	$1\frac{1}{2}$	2
Each.....	\$1.13	1.25	1.75	2.25	2.50	3.00	3.50

† Carried in San Francisco only.

† **PLUMBERS' TOOL BAGS.**

MADE OF BRUSSELS CARPET. LEATHER BOUND.

Code	Locitator	Lockenkap
Numbers.....	2	3
Each.....	\$5.00	6.00

No. 2 has Leather Bottom.

No. 3 has Leather Bottom and Sides.

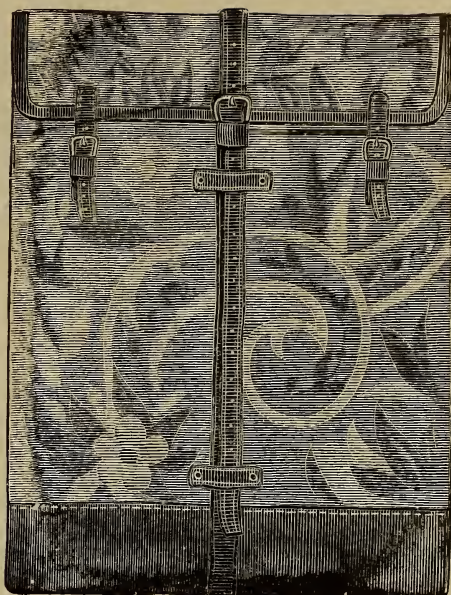

Cut shows No. 2.

† **IRON PLUMB BOBS.**

Code	Lockhame	Lockvoge
Sizes.....	Small	Large
Per dozen.....	\$1.20	2.00

Loose.

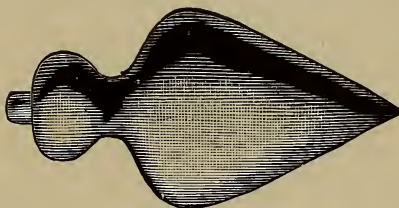

† **TAP BORERS.**

EXTRA HEAVY SHANKS.

Code	Locomote
Style.....	Philadelphia Pattern
Per dozen.....	\$5.00

One dozen in a box.

† Carried in San Francisco only.

†TAP BORERS.

EXTRA HEAVY SHANKS.

Code..... Loculado
 Style..... New York Pattern
 Per dozen..... \$5.00

One dozen in a box.

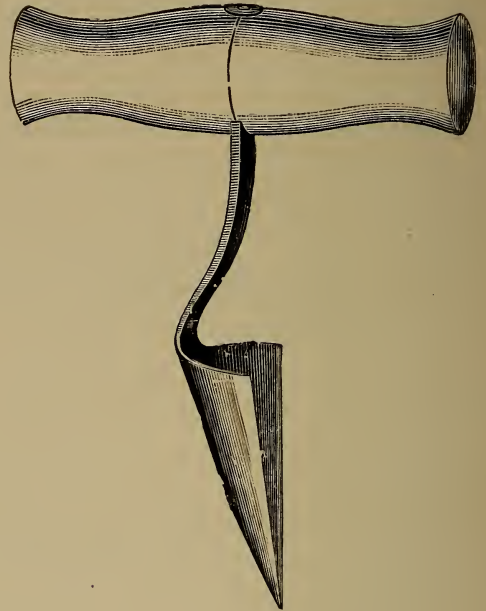

†GREASE, ROSIN AND FLOUR BOXES.

BRASS POLISHED

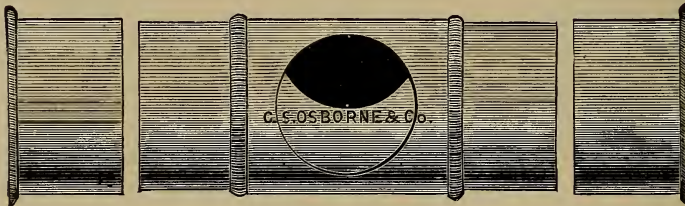

Code.....
 Locutori.....Medium size.....Per dozen, \$18.00

One-half dozen in a box.

†WIRE PIPE BENDERS.

STEEL WIRE. JAPANNED.



Code	Lodabilit	Lodiator	Lodicent	Lodomero
Size, inches.....	1	1¼	1½	2
Length, inches.....	23	23	23	23
Each.....	\$0.75	.80	.90	1.00

†Carried in San Francisco only.

†VANDERMAN'S ELASTIC LEAD PIPE BENDERS.



Cut shows round trap bent around a 3-inch Soil Pipe and Bender easily withdrawn.

Directions for Using.

Shove or draw the Bender into the pipe until the point is reached where the bend is to be made, and bend the pipe. The Bender can then be easily removed. If the bends in the pipe are very short or close and the Bender does not come out of the pipe easily, it can be made to do so by slackening up a little on the bends. To make a bend midway in a long length of pipe, attach a wire or strong cord to each end of the Bender, so as to draw it in and out. If the bends are short, or more than one in number, the Bender will work in and out more easily by lubricating the Bender or the inside of the pipe with oil, soap or water.

Code.....	Lofgebe	Loforine	Lofreden
Numbers.....	2	3	4
Size pipe, inches.....	1 1/4	1 1/2	2
Length, inches.....	24	24	24
Each.....	\$1.75	2.00	2.50

†DUSTERS.

ALL BRISTLE.

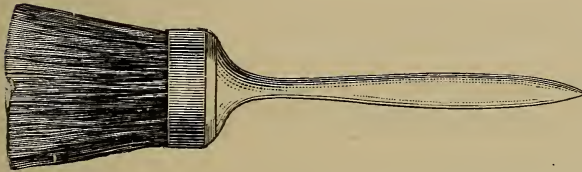

Code.....	Lofwarde
Diameter, inches.....
Per dozen.....	\$7.00
One dozen in a box.	

†FLAT SOIL BRUSHES.

ALL BRISTLE.

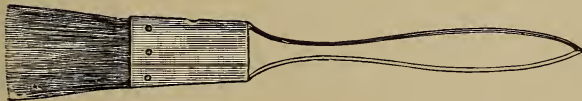

Code.....	Logarito
Width, inches.....
Per dozen.....	\$1.00
One dozen in a box.	

†ROUND SOIL BRUSHES.

ALL BRISTLE.



Code.....	Logbake
Diameter, inches.....
Per dozen.....	\$0.75
One dozen in a box.	

†Carried in San Francisco only.

† **LANTERN CHISELS.**

CAST STEEL.



Code..... Logenlite
 Each..... \$0.12

One dozen in a box.

† **WIRE CHISELS.**

CAST STEEL.

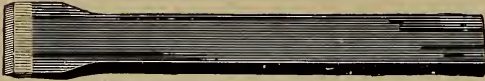

Code.....	Logenzind	Logical	Logistico	Logograph
Inch.....	¼	⅜	½	⅝
Each.....	\$0.08	.09	.10	.11
Wt. per doz., lbs.

One dozen in a box.

Code.....	Logomante	Logoteen	Logradour	Lohnsatz	Lohnsold	Lokalite	Lokalton	Lokgifte
Inches.....	¾	⅞	1	1 ⅛	1 ¼	1 ½	1 ¾	2
Each.....	\$0.12	.13	.14	.15	.17	.20	.24	.29
Weight per doz., lbs.....	2	3	3 ½	4	4 ¾	6	7	8

One-half dozen in a box.

† **PLUMBERS' COLD CHISELS.**

OCTAGON STEEL.



Code.....	Lollardi	Lollhard	Lolling
Length, inches.....	6	8	10
Blade, inch.....	1	1	1
Per dozen.....	\$5.00	6.00	7.25

† **FORGED STEEL COLD CHISELS.**

OCTAGON. HALF-POLISHED. TURNED HEADS.



No. 1.

Code.....	Lomander	Lombarda	Lombatel	Lombrico	Lomentor	Lompenn
Inch.....	⅜	½	⅝	¾	⅞	1
Per dozen.....	\$3.60	4.50	6.00	7.50	10.00	12.80
Weight per doz., lbs.....	2	4	7	10	14	18

One-half dozen in a box.

† Carried in San Francisco only.

† **CAPE CHISELS.**

OCTAGON CAST STEEL.



Code	Lonchere
Inch.....	¼
Per dozen.....	\$6.00
Weight per doz., lbs.....	6

† **DIAMOND NOSE CHISELS.**

OCTAGON CAST STEEL.



Code	Londiner
Per dozen.....	\$6.00
Weight per doz., lbs.....	12

† **ROUND NOSE CHISELS.**

OCTAGON CAST STEEL.



Code	Longader
Per dozen.....	\$6.00
Weight per doz., lbs.....	12

† **HALF-ROUND NOSE CHISELS.**

OCTAGON CAST STEEL.



Code	Longbreck
Per dozen	\$6.00
Weight per doz., lbs.....	12

† Carried in San Francisco only.

† **WOOD CHISELS.**

ROUND CAST STEEL.



Code	Longipede	Longirust	Longiturn
Inches	1	1½	2
Length, inches	10½	10½	14
Per dozen	\$6.00	9.00	11.50
Weight per doz., lbs.....	10½	23

† **FLOOR CHISELS.**

ROUND CAST STEEL.



Code.....	Longkame	Longmeter	Longmind
Inches.....	2	3	3
Length, inches.....	9	12	15
Per dozen.....	\$20.00	20.00	20.00
Weight per doz., lbs.....

† **FLOOR CHISELS.**

OCTAGON CAST STEEL.



Code	Longprim
Inches	4
Length, inches	16
Per dozen	\$22.00
Weight per doz., lbs	34

†Carried in San Francisco only.

†H. M. & S. CAULKING CHISELS.

FORGED STEEL. OIL TEMPERED.



Code	Longulano	Loodacht
Size	Small	Large
Width, inch	$\frac{5}{8}$	$\frac{3}{4}$
Thickness of blade at end, inch.....	$\frac{1}{4}$	$\frac{1}{4}$
Per dozen	\$5.00	6.00
Weight per doz., lbs.....	11	12

†H. M. & S. CAULKING CHISELS WITH OFFSET.

FORGED STEEL. OIL TEMPERED.

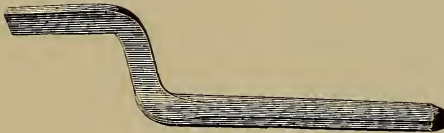

Code	Loodert	Loodspar
Style	Right	Left
Thickness of blade at end, inch.....	$\frac{3}{16}$	$\frac{3}{16}$
Per dozen	\$5.00	5.00
Weight per doz., lbs.....	12	12

†H. M. & S. CAULKING CHISELS FOR CORNERS.

FORGED STEEL. OIL TEMPERED.



Code	Looter
Thickness of blade at end, inch.....	$\frac{3}{16}$
Per dozen	\$5.00
Weight per doz., lbs.....	12

† Carried in San Francisco only.

† **H. M. & S. YARNING CHISELS.**

FORGED STEEL. OIL TEMPERED.



Code	Lopadist	Loquacita
Size	Small	Large
Width of blade, inch.....	$\frac{5}{8}$	$\frac{3}{4}$
Length of blade, inches	6	6
Thickness of blade at end, inch.....	$\frac{3}{32}$	$\frac{3}{32}$
Per dozen.....	\$5.00	6.00
Weight per doz., lbs.....	11	12

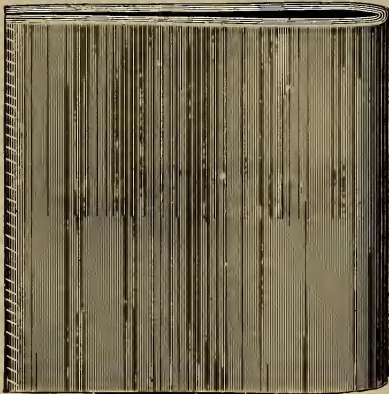

Cut Shows Mole Skin Cloth.

† **WIPING CLOTHS.**

TALLOW DIPPED.

Mole Skin.

Code.....	Loquebard	Loquelari	Loramenti
Inches.....	$2\frac{1}{2} \times 2$	$2\frac{1}{2} \times 2\frac{1}{2}$	$3 \times 2\frac{1}{2}$
Per dozen.....	\$2.50	2.50	2.50
Code.....	Lordatos	Lordope	
Inches.....	3×3	$3\frac{1}{2} \times 3\frac{1}{2}$	
Per dozen.....	\$2.50	2.50	

One dozen in a package.

Ticking.

Code	Loricanda	Loricarum	Loroglass	Lorquina	Losauker	Losband
Inches.....	2×2	$2\frac{1}{2} \times 2$	$2\frac{1}{2} \times 2\frac{1}{2}$	$3 \times 2\frac{1}{2}$	3×3	$3\frac{1}{2} \times 3\frac{1}{2}$
Per dozen.....	\$1.50	1.50	1.50	1.50	1.50	1.50

One dozen in a package.

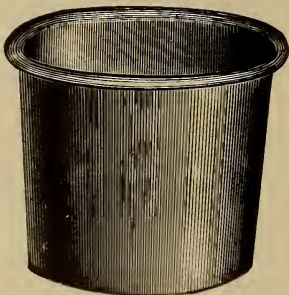

† **SOIL CUPS.**

SEAMLESS COPPER WITH BAIL.

Code.....	Losbindin	Losbolles
Size.....	Small	Large
Inches.....	$2\frac{1}{2} \times 2\frac{1}{2}$	3×3
Per dozen.....	\$5.00	5.50

One-half dozen in a package.

† Carried in San Francisco only.

RUBBER FORCE CUPS.

BLACK ENAMELED WOOD HANDLES. FOR CLEANING THE DISCHARGE PIPES OF WASH BOWLS, BATH TUBS, SINKS, ETC.

Code.....	Losdonner	Loswicker	Lothperle
Numbers	†1	†2	3
Diameter, inches.....	3	3¾	4½
Per dozen.....	\$3.00	4.50	6.00

One-half dozen in a box.



PLUMBERS' FRIEND.

WOOD HANDLES. RUBBER CUPS.

Code.....	Lothquack	Lothquarl	Lotiform
Style.....	†No.0. NoValve	†NoValve	WithValve
Length of handle, inches	27	38	38
Diameter of cup, inches..	4	4	4
Each.....	\$1.75	1.75	2.00
Weight each, lbs..	1	1½	1½

†**SAMSON PLUMBERS' FORCE CUP.**

WOOD HANDLES. RUBBER CUP. WITH VALVE.

Code	Lotigali
Length of handle, inches.....	48
Diameter of cup, inches.....	6
Each.....	\$4.00
Weight each, lbs.....	2



Rubber Cup

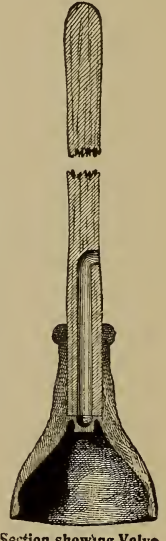

Section showing Valve and Air Passage

SOLDER COPPERS.

POINTED



Code	Lotomeet	Lotosortie	Lotsbest	Lotterban	Lottokar	Lotusblum	Loubane	Louca men	Loucha
Numbers.....	1	†1½	2	3	4	5	6	†7	†8
Weight per pair, lbs	1	1½	2	3	4	5	6	7	8
Per pound	\$.....

†**BOTTOM COPPERS.**

FLAT.



Code	Lounger	Louvanist	Louvetter	Lowering
Numbers	3	4	5	6
Weight per pair, lbs.....	3	4	5	6
Per pound	\$.....

† Carried in San Francisco only.

† **HATCHET COPPERS.**

SWIVEL HEADS.

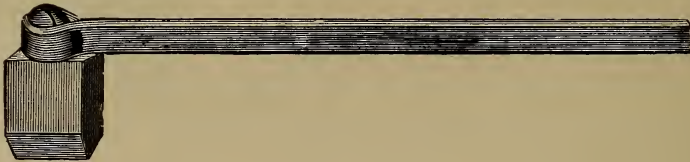

Code	Loxarthur	Loxocost	Loyalist
Numbers	4	5	6
Weight per pair, lbs.....	4	5	6
Per pound.....	\$.....

ROOFING COPPERS.

WITH HANDLES AND SHIELDS.



Code.....	Lozangate	Lubeck	Lubricor	Lucentibo
Numbers.....	10	† 11	† 12	† 18
Weight per pair, lbs.....	10	11	12	18
Per pound.....	\$.....

† **ROUND IRONS.**

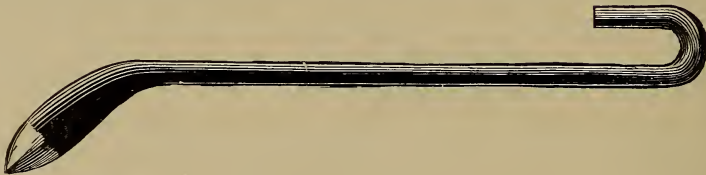

Code.....	Lucernato	Luchadore	Luchaste
Numbers	1	2	3
Per dozen	\$8.00	11.00	13.00

SOLDER COPPER HANDLES.

SOFT WOOD. WIRE FERRULES.

Code.....	Luchetto	Lucidaro
Size.....	Medium	†Extra Large
Per dozen.....	\$0.45	1.15
Weight per doz., lbs.....	3	5

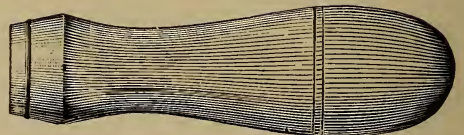

Packed as ordered.

†Carried in San Francisco only.

† **REGISTERING
WASHER CUTTERS.**

FINEST QUALITY OF TOOL STEEL. RULE $\frac{1}{16}$
TO $2\frac{1}{4}$ INCHES, BOTH SIDES.

Code.....	Luciparen
Number.....	45
Per dozen.....	\$20.00
Weight per doz., lbs.....	8 $\frac{1}{4}$
One-half dozen in a box.	



† **WASHER CUTTERS.**

CAST STEEL.

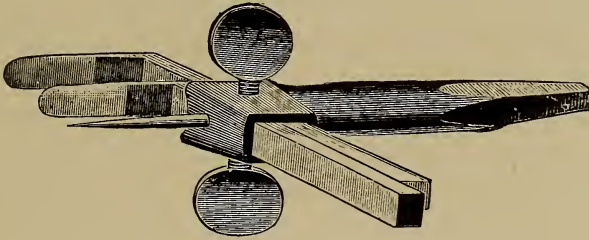

Code	Luckless
Number	1
Per dozen.....	\$10.00
Weight per doz., lbs.....	6

One-half dozen in a box.

† **VANDERMAN'S LEAD PIPE CUTTERS.**

JAPPANED. CUTS LEAD PIPE FROM $\frac{3}{8}$ TO $1\frac{1}{2}$ INCHES.

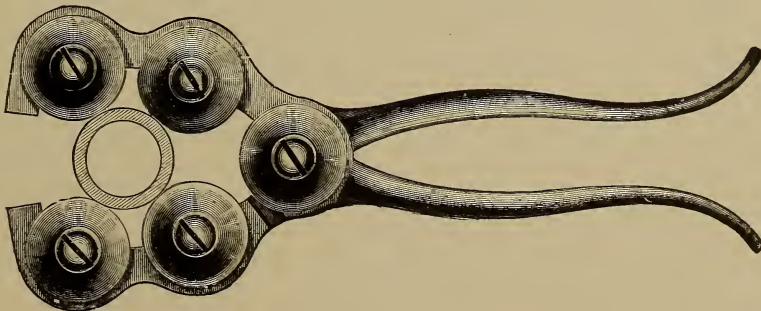

Code.....	Cutter.....	Each,	\$2.00
Lucration.....	Extra Cutter Wheels.....	“	.10

† Carried in San Francisco only.

† **HEADSON PIPE CUTTER.**

LEAVES THE PIPE ABSOLUTELY FREE FROM ALL BURRS, INSIDE AND OUT. CUTS AS CLEAN AND SMOOTH AS A LATHE. DOES NOT JAM OR SWELL THE END OF THE PIPE. IS AUTOMATIC IN ADJUSTMENT AND DOES AWAY WITH SCREW MOVEMENT.



Code	Lucratrust	Lucratusel	Lucratur
Number	1	2	3
Cuts pipe, inches.....	¼ to 1	1 to 2	2 to 4
Each	\$12.50	12.50	25.00
Weight each, lbs.....	3½	6	20

THE CUTTER THAT CUTS. ALMOST INDESTRUCTIBLE.

- | | |
|----------------------------|--------------------------------|
| Saves reaming the pipe. | Saves cracking or grooving. |
| Saves crushing. | Leaves no burrs. |
| Tool can be ground. | All parts are interchangeable. |
| Does more and better work. | Lasts longer. |

It is not the first cost of a tool, but the amount of work performed that tells the story.

Description :

The above cut represents the Cutter in operation with 1-inch pipe, showing the manner of holding pipe between the anti-friction roller and inserted jaw No. 10 and is adjusted to the pipe by merely pushing the handle forward until anti-friction rolls come in contact with pipe. Then take up lost motion by turning the fluted handle No. 5 which causes the frame portion 3 to slide on the main frame, thus making adjustments for all size pipes. No. 0 is the cutting tool and is ½ inch wide, ⅜ inch thick and 2 inches long and is made of air hardening steel, and is so made that it can be ground red hot on an emery wheel and still retain its temper. To operate the cutting tool after the pipe is in position turn ball until knife touches the pipe, then turn cutter one revolution of the pipe. Then feed cutting tool ¼ turn for each revolution of cutter until pipe is cut off. Tool No. 0 never projects more than the thickness of the pipe while cutting. This tool is reversible, being ground on both ends.

CAUTION—Always be sure that cutter is fastened firmly to pipe before feeding in the cutting tool.

† Carried in San Francisco only.

BARNES' PIPE CUTTERS.

THREE WHEELS.



Code.....	Lucrava	Lucretil
Numbers.....	1	2
For pipe, inches.....	1/8 to 1	1/2 to 2
Each.....	\$4.50	6.00
Weight each, lbs.....	3 1/4	5

Extra Cutter Wheels.

Code.....	Lucrifica	Lucrifugit
Numbers.....	1	2
Each.....	\$.025	.30

Extra Wheel Pins.

Code.....	Lucrosaro	Luctabite
Numbers.....	1	2
Per dozen.....	\$1.00	1.00

† **STANWOOD'S PIPE CUTTERS.**

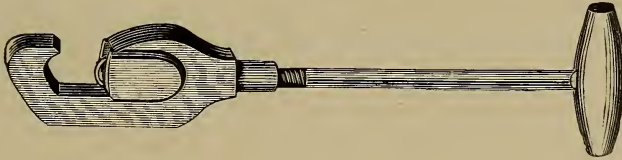

Code.....	Luctamino	Luctatore	Luctavimo
Numbers.....	1	2	3
For pipe, inches.....	1/8 to 1	1 to 2	2 to 3
Each.....	\$1.50	2.25	7.00
Weight each, lbs.....	3 1/2	8 1/2	24

Extra Cutter Wheels.

Code.....	Lutifeit	Luctisano	Lucubrado
Numbers.....	1	2	3
Each.....	\$.012	.18	.25

Extra Blocks and Wheels.

Code.....	Lucubrated	Luculent	Lucullano
Numbers.....	1	2	3
Each.....	\$.040	.60	1.00

SAUNDERS' PIPE CUTTERS.



Code.....	Ludabank	Ludendor
Numbers.....	1	2
For pipe, inches.....	1/8 to 1	1 to 2
Each.....	\$3.00	4.50
Weight each, lbs.....	3 1/2	6 1/2

Extra Cutter Wheels.

Code.....	Ludergale	Ludibunt	Ludicott
Numbers.....	1	2	3
Each.....	\$.024	.32	.60

† **Extra Rollers.**

Code.....	Ludicrabo	Ludificat
Numbers.....	1	2
Each.....	.24	.32

Extra Pins.

Code.....	Ludmille	Luendise
Numbers.....	1	2
Each.....	.10	.10

† Carried in San Francisco only.

† **WING DIVIDERS.**

FORGED CAST STEEL. FULL POLISHED.

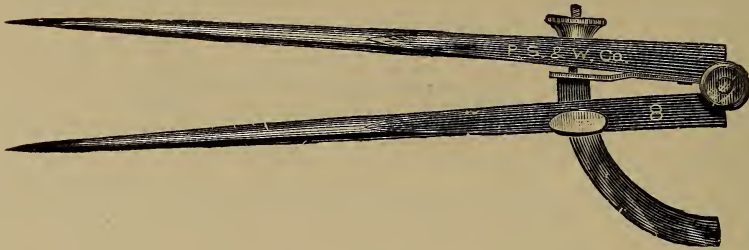

Code	Luftballe	Luftdrum	Luftmetor	Luftsalz	Luftvulk	Lugarena	Lugmarte
Inches.....	8	9	10	12	15	18	24
Per dozen.....	\$7.50	9.00	10.00	12.00	18.00	25.00	36.00
Weight per doz., lbs.....	6	7½	9	12	16	24

One-half dozen in a box.

† **HURWOOD'S SCREW DRIVERS.**

INDESTRUCTIBLE. WARRANTED BEST QUALITY STEEL.



The steel extends from point of blade through the handle, and forms a top for rough use. Impossible to twist the handle on the steel. No amount of hammering on the head can injure the handle.

Code.....	Luizenest	Lulismore
Inches.....	4	6
Per dozen.....	\$4.25	6.00
Weight per doz., lbs.....	2½	4

One-half dozen in a box.

† **HURWOOD'S MACHINE SCREW DRIVERS.**

¾-INCH STEEL. A GOOD SCREW DRIVER FOR LINEMEN. INDISPENSABLE FOR PLUMBERS AND STOVE MOUNTERS. ESPECIALLY ADAPTED FOR HEAVY WORK IN PLACES WHERE IT IS IMPOSSIBLE TO USE A LONGER DRIVER.

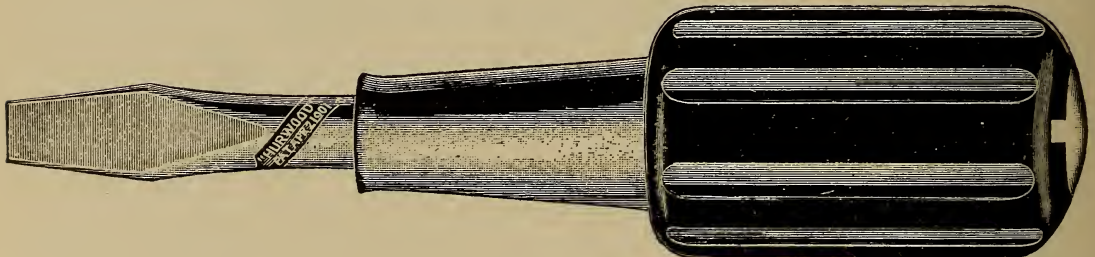

Code	Cut shows Full Size.	Lumachist
Number.....		5
Entire length, inches.....		5½
Blade, inches.....		1¾
Per dozen.....		\$5.00
Weight per doz., lbs.....		5½

One-half dozen in a box.

† Carried in San Francisco only.

† **SUCCESS EMERY GRINDER.**

FOR STOVE DEALERS, PLUMBERS, TINNERS, BICYCLE REPAIRMEN, BLACKSMITHS, JEWELERS
 CARPENTERS, BUTCHERS, HARNESSMAKERS, WAGONMAKERS,
 MECHANICS, FARMERS AND MINERS.



For grinding Drills, Castings, Machine Parts, Knives, Scissors, and all kinds of Tools.

This machine when set up stands 4 feet high; the upright or standard is made of 3/4-inch tubing, and is very solid and strong. The emery wheel is of the highest grade and is **8 inches in diameter by 1 1/4 inches face**. It is supplied with a suitable and substantial rest. It has no belt to slip, loosen or break, neither has it lead teeth to wear out and bind.

The movement of the foot operates a ball ratchet, which drives the emery wheel at **3,000 revolutions per minute**.

The machine screws to the floor and wall, and is quickly and easily set up.

Can also be used for buffing.

Code	Lumine
Each complete with one emery wheel	\$6.50
Weight each, lbs25
Shipping measurement, cubic feet

One in a crate.

Code.....	Luminedo
Extra emery wheels, each	\$1.25
Code.....	Luminoa
Cotton buffing wheels, each	\$1.25

† Carried in San Francisco only.

† **BREAST DRILLS.**

GEARED. COMPLETE WITH THREE DRILLS AND ONE REAMER.

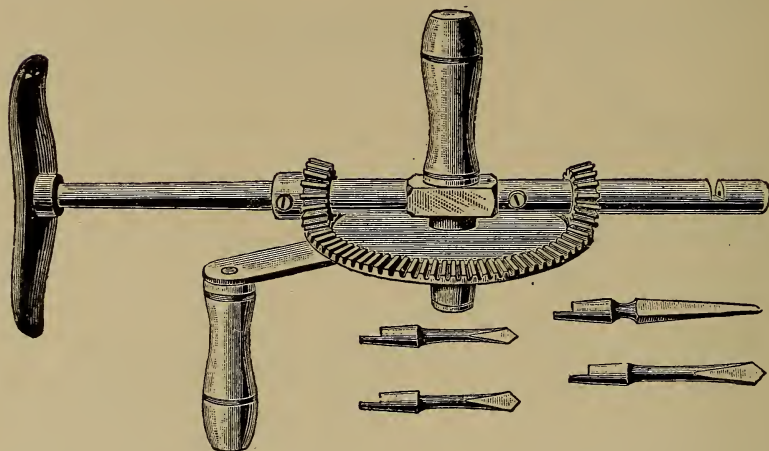

Code	Lumbagin	Luminand
Numbers	1	3
Each	\$3.60	2.50
Weight each, lbs	6 ³ / ₄	6 ¹ / ₂

One in a box.

No. 1 is double-gearred and polished. No. 3 is single-gearred and japanned.

† **DRILL BRACES.**

HOLDS ROUND OR SQUARE SHANK DRILLS OR BITS. NICKEL-PLATED FRAME AND CHUCK. BALL BEARING.

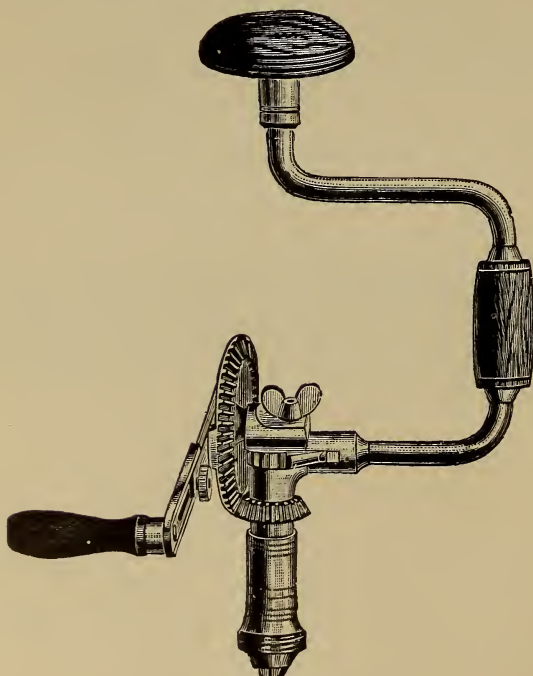

Code.....	Luminater
Each	\$3.00
Weight each, lbs.....	4 ¹ / ₂

One in a box.

† Carried in San Francisco only.

TINNERS' MALLET.

SELECTED HICKORY.

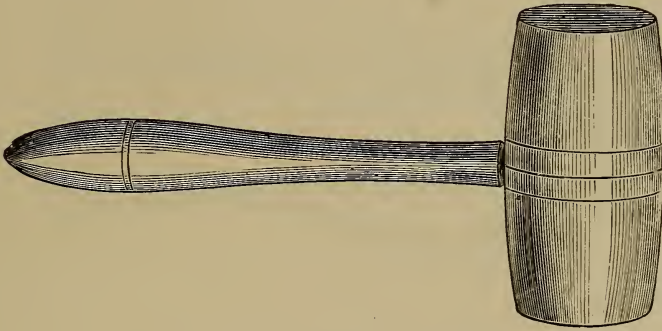

Code	Luminosity	Lumpish	Lunabito	Lunarian	Lunatico	Lunatism	Lungaman	Lupareido
Inches	2	†2¼	2½	†2¾	3	3½	4	†2x3
Per dozen	\$1.50	1.75	2.00	2.25	3.00	3.50	4.00	1.25
Weight per doz., lbs	9	11	12	13½	15	18	24

Loose.

†PLUMBERS' SIDE EDGES.

BEST.

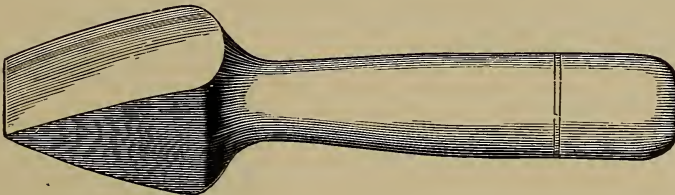

Code	Lupientos
Per dozen	\$8.50
Weight per doz., lbs	3½

Loose.

†PLUMBERS' DRESSERS.

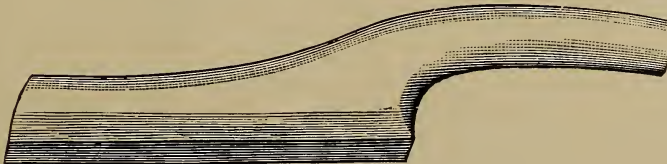

Code	Lurcabamo	Lurcantim
Quality	Best	Dogwood
Per dozen	\$10.00	8.00
Weight per doz., lbs	18	12

Loose.

†Carried in San Francisco only.

† **BOSSING STICKS.**

BEST.



Code	Lurcavist
Per dozen.....	\$10.00
Weight per doz., lbs.....	8

Loose.

† **DRIFT PLUGS.**

BOXWOOD.

Code.....	Luridato	Lusingame	Lusitamo	Lustgang
Inches.....	1	1¼	1½	2
Per dozen....	\$2.00	2.00	2.00	2.00
Wt. doz., lbs	$\frac{2}{3}$	1	1½	3

Loose.



† **TURN PINS.**

BEST.

Code.....	Lustihate	Lustijag	Lustparty
Numbers.....	1	2	3
Largest diameter, in....	1½	2	2½
Per dozen	\$3.00	3.00	3.00
Weight per doz., lbs....	1¼	3¾	5

Loose.

† Carried in San Francisco only.

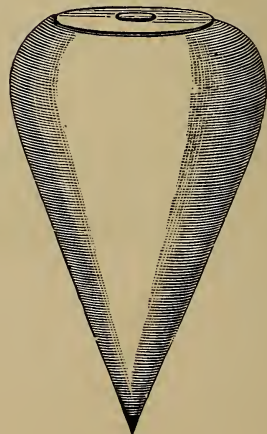

† **SHAVE HOOKS.**

STEEL BLADES. BLACK ENAMELED WOOD HANDLES.

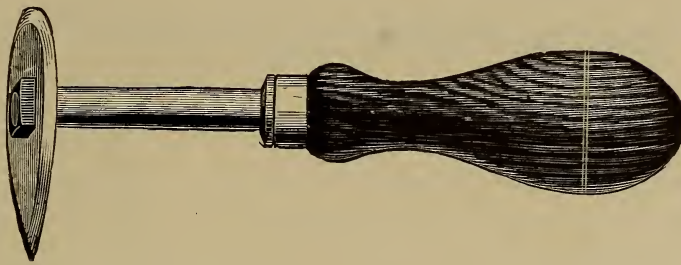

Cut Shows Oval Hook.

Code	Lustraron	Lustrica	Lustrific
Style	Tringle	Oval	Adjustable
Per dozen	\$3.50	3.50	6.00
Weight per doz., lbs.....	2½	2½	3½

One-half dozen in a box.

The Adjustable Hook has an oval head that can be set at any angle to the handle.

† **POT HOOKS.**

MADE OF ¼-INCH STEEL ROD.



Code	Lustrous
Length, inches.....	13
Per dozen.....	\$1.50
Weight per doz., lbs.....	4½

† **FLAT FILES.**



Code	Lustwound	Lutandari	Lutanist	Lutheran
Inches	8	10	12	14
Per dozen.....	\$5.30	7.00	9.70	13.30
Weight per doz., lbs.....	4	8½	13½	21

8-inch, one dozen in a box. 10 to 14-inch, one-half dozen in a box.

† **ROUND FILES.**

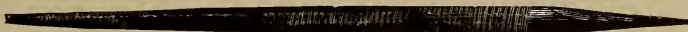

Code	Lutherite	Lutodare	Lutricol
Inches	10	12	14
Per dozen.....	\$5.60	7.50	10.70
Weight per doz., lbs.....	3½	9½	14½

10-inch, one dozen in a box. 12 and 14-inch, one-half dozen in a box.

† Carried in San Francisco only.

† **HALF-ROUND FILES.**



Code.....	Lutsmut	Lututento	Luxabimo	Luxacion
Inches.....	8	10	12	14
Per dozen.....	\$7.50	9.10	11.80	15.50
Weight per doz., lbs.....		9½	12	18½

One-half dozen in a box.

† **THREE-SQUARE FILES.**



Code.....	Luxandit	Luxisti
Inches.....	10	12
Per dozen.....	\$9.10	11.80
Weight per doz., lbs.....	9½	12

One-half dozen in a box.

† **HALF-ROUND WOOD RASPS.**



Code.....	Luxuriato	Luxurist	Luzerne
Inches.....	10	12	14
Per dozen.....	\$13.70	18.70	24.80
Weight per doz., lbs.....	7	12	17

One-half dozen in a box.

† **HAND GROOVERS.**

FORGED STEEL.

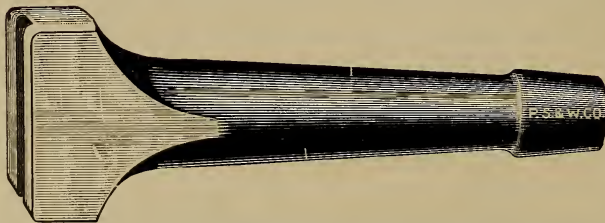

Code.....	Luzidios	Lycabet	Lycapsor	Lycomedes	Lycotropic	Lycurgid	Lydamar	Lydesto	Lydock	Lydrome
Numbers.....	00	0	1	2	3	4	5	6	7	8
Groove, inch...	½	⅞	1 ⅓	¾	⅝	¼	⅜	⅝	⅜	⅞
Each.....	\$0.75	.75	.63	.63	.50	.50	.37	.37	.25	.25
Weight each, lbs...	1¼	1½	1	1	¾	¾	¾	¾	¾	¾

Loose.

† Carried in San Francisco only.



† **PLUMBERS' TORCHES.**

POLISHED.

Code.....	Ma bellin	Ma boud er
Style.....	Tin	Brass
Per dozen.....	\$8.00	15.00
Weight per doz., lbs.....	10	12
	Loose.	

† **LOOKING GLASSES.**

PLATE GLASS. BRASS BOUND.



Code.....	Ma cado
Inches.....	2 5/8 x 3 7/8
Per dozen.....	\$4.00
Weight per doz., lbs.....	5

One-half dozen in a box.

† Carried in San Francisco only.

† **WIRE GAUGES.**

ROUND. POLISHED CAST STEEL. ENGLISH STANDARD.

Code	Macadure	Macafurst
Number.....	1	2
Gauge Nos.....	0 to 36	6 to 36
Per dozen.....	\$24.00	18.00
Weight per doz., lbs.....	3¼	1¾

One-half dozen in a box.

Same as Stubs' or Birmingham Gauge.



† **BALL PEIN HAMMERS.**

EXTRA QUALITY CAST STEEL. POLISHED. SECOND GROWTH HICKORY HANDLES.

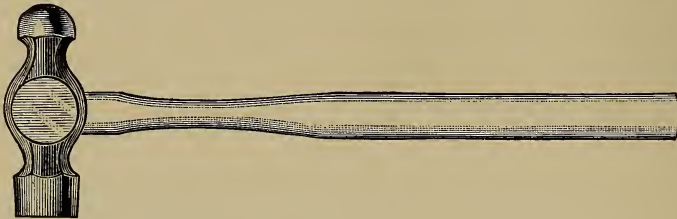

Code	Macalong	Macamora	Macanilo
Numbers.....	124	125	126
Old numbers	73	74	75
Size.....	1	0	00
Weight each, unhandled, lbs.....	1¼	1	¾
Per dozen.....	\$12.25	11.25	10.50
Weight per doz., lbs.....	22	18	15

One-third dozen in a box.

† **STRAIGHT PEIN HAMMERS.**

EXTRA QUALITY CAST STEEL. POLISHED. SECOND GROWTH HICKORY HANDLES.

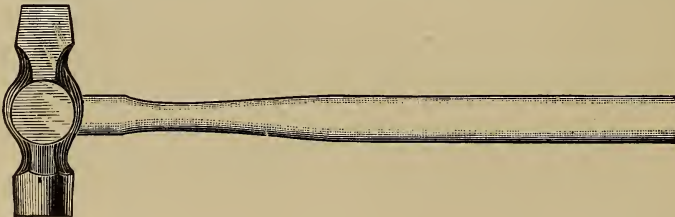

Code	Macarena	Macariote	Macaroni
Numbers	0	1	2
Weight each, unhandled, lbs.....	1	1¼	1½
Per dozen.....	\$12.50	13.50	14.50
Weight per doz., lbs.....	18	22	26

One-third dozen in a box.

† Carried in San Francisco only.

†**PLUMBERS' HAMMERS.**

EXTRA QUALITY CAST STEEL



Code	Maccabee	Macchias
Size	Small	Large
Per dozen.....	\$9.00	12.00
Weight per doz., lbs.....

One-third dozen in a box.

†**TINNERS' RIVETING HAMMERS.**

POLISHED. CAST STEEL. VARNISHED HANDLES.

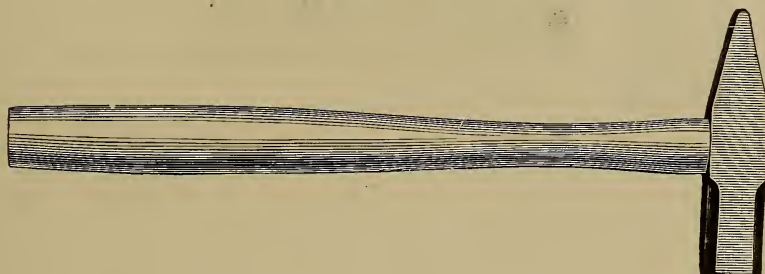

Code.....	Macchinose	Maceadore	Macebimo	Macedoni	Macellast	Macellinut
Numbers.....	0	1	2	3	4	5
Face, inches.....	1½	1⅞	1	⅞	¾	⅝
Per dozen	\$15.50	9.75	8.31	6.75	5.31	4.75
Weight per doz., lbs.....	19	15	11	8	6

One-half dozen in a box.

†**TINNERS' SETTING HAMMERS.**

POLISHED. CAST STEEL. VARNISHED HANDLES.

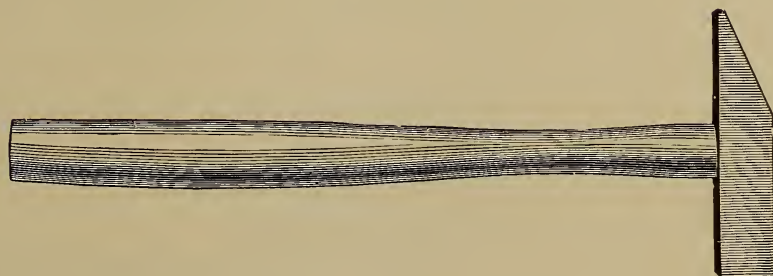

Code.....	Maceradom	Machabeo	Machacado	Machadine	Machanida
Numbers.....	1	2	3	4	5
Face, inches.....	1⅞	1	⅞	¾	⅝
Per dozen	\$9.75	8.31	6.75	5.31	4.75
Weight per doz., lbs.....	20	15	11	8	6

One-half dozen in a box.

†Carried in San Francisco only.

† **TINNERS' RAISING HAMMERS.**

CAST STEEL. POLISHED FACES. SELECTED HANDLES.

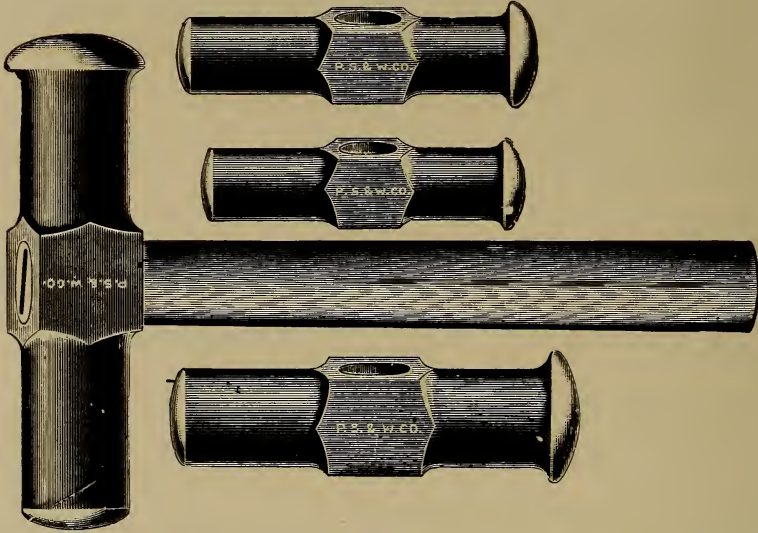

Code.....	Machinale	Machinise	Machuron	Maciform
Numbers.....	1	2	3	4
Diameter small head, inches.....	1 5/8	1 1/2	1 1/4	1
Diameter large head, inches.....	2 1/4	2	1 3/4	1 1/4
Weight each, unhandled, lbs.....	5	3 3/4	2 1/4	1 1/4
Handled, each.....	\$2.35	1.85	1.35	.85
Weight per doz., lbs.....	60	42	24	18

Loose.

† **PLANISHING HAMMERS.**

WITHOUT HANDLES.

Code.....	Macinava	Macomade
Weight each, lbs.....	1 1/4	1 1/2
Per pound.....	\$1.00	1.00

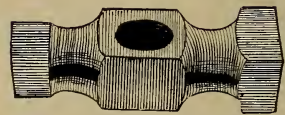

Loose.

BLACK EAGLE HATCHETS.

ALL STEEL. OIL TEMPERED. HANDLE JAPANED BLACK. BLADE POLISHED.

Code	Macomute
Length, inches	12 1/2
Width of blade, inches	4
Per dozen.....	\$7.00
Weight per dozen, lbs.....	18



One-half dozen in a box.

† Carried in San Francisco only.

† **CHIPPING KNIVES.**

FORGED FROM EXTRA QUALITY STEEL. LEATHER SCALES.

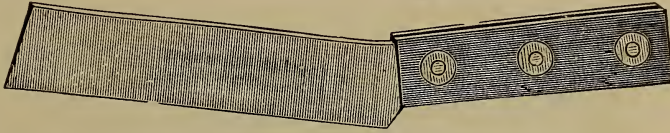

Code.....	Macquera	Macriano	Macritate
Length of blade, inches.....	4½	5	6
Per dozen	\$6.00	6.00	6.00
Weight per doz., lbs.....	4	5	6

Loose.

MELTING LADLES.

FORGED OF BEST CHARCOAL IRON. EXTRA HEAVY. SINGLE LIP. RIVETED HANDLES.

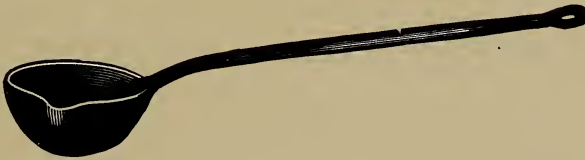

Code.....	Macrobio	Macroglen	Macrotar	Macrozam	Mactabite	Maculate	Maculeron
Size, inches.....	2½	3	†3½	4	†4½	†5	†6
Per dozen.....	\$2.75	3.25	3.50	4.00	4.50	5.00	6.00
Weight per doz., lbs.....	7½	8¼	9¼	10½	13	15¼	18

One-half dozen in a package.

SOLDER POTS.

CAST IRON.



Code.....	Maculosa	Madablom	Madamisell	Madaracte	Maddalon	Maddener	Madefacto
Numbers.....	†1	†2	†3	†4	5	6	†7
Top diameter, inches.....	5	6	6½	8	9	10½	13½
Each.....	\$0.50	.65	.70	1.10	1.30	1.75	3.50
Weight each, lbs.....	3½	7	11	13	16	19½	24

† Carried in San Francisco only.

† **SOLDER MOULDS.**

CAST IRON.



Code.....	Madegast
Style.....	Two Bar
Top measure, inches.....	5x10
Each.....	\$0.65
Weight each, lbs.....	11

† **STRAP SOLDER MOULDS.**

CAST IRON.



Code.....	Madentibo
Style.....	Ten Bar
Inches.....
Each.....	\$2.75
Weight each, lbs.....

† Carried in San Francisco only.

† **HOTCHKISS' PATENT CUTTING NIPPERS.**



Cutting parts made to gauge of choice steel. Can be taken off to be ground, and when worn out can be replaced at slight expense, making the tool as good as new. All extra cutters warranted to interchange. The center of rivet being only three-fourths of an inch from the cutting edge, they have nearly double the cutting power of most other styles.

Code.....	Madescun	Madidare	Madorette	Madracaro
Numbers.....	1	2	3	4
Inches.....	12	11	10	8
Each.....	\$2.25	2.00	1.75	1.50
Weight each, lbs.....	2	1¾	1¼	1

One in a package.

† **Extra Cutters for Hotchkiss Nippers.**

Code.....	Madreclam	Madretorm	Madreport	Madrigado
Numbers.....	1	2	3	4
Per pair.....	\$0.40	.40	.40	.35

† **IMPROVED CUTTING NIPPERS.**

EXTRA CAST STEEL. SOLID JAWS.

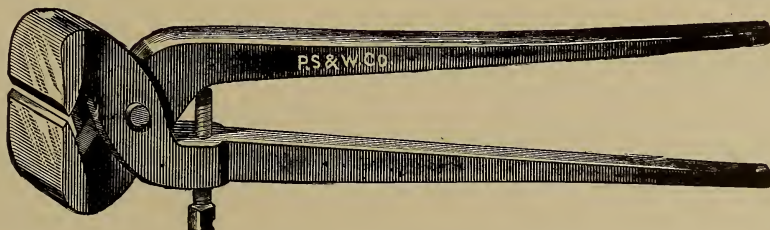

Code.....	Madrigals	Madrugada	Madrugone	Madulsare	Maduramo
Numbers.....	1	2	3	4	5
Inches.....	12	11	10	8	7
Each.....	\$2.25	2.00	1.50	1.40	1.00
Weight each, lbs.....	2¼	1½	1¼	1	¾

One-half dozen in a package.

† Carried in San Francisco only.

CHACE'S ZINC OILERS.

SPRING BOTTOMS.

Code.....	Krumpel	Krystal	Kubikfut	Kuchent
Numbers	0	1	2	3
Capacity	½ gill	¾ gill	1¾ gills	½ pt.
Diameter, inches	2⅞	2⅝	3¼	3¾
Per dozen	\$1.25	1.50	2.00	2.25
Weight doz., lbs.	1	1¼	2	2¾
Code	Kuddebor	Kugelart	Kugelass	
Numbers	4	5	6	
Capacity	¾ pt.	1 pt.	1¼ pts.	
Diameter, inches	4⅞	4¾	4¾	
Per dozen.....	\$2.75	3.50	4.50	
Weight per doz., lbs.....	3¼	3½	4	

Nos. 0 and 1, one dozen in a box.
 Nos. 2 to 6, one-half dozen in a box.



†CHACE'S BRASS OILERS.

SPRING BOTTOMS.

Code.....	Kugelkarn	Kugelmode	Kugelstunt
Numbers.....	2	3	4
Capacity	1¾ gills	½ pt.	¾ pt.
Diameter, inches	3¼	3¾	4⅞
Per dozen.....	\$3.50	4.00	4.75
Weight per doz., lbs...	2	2¾	3¼
Code	Kugelwahr	Kugelzon	
Numbers	5	6	
Capacity	1 pt.	1¼ pts.	
Diameter, inches	4¾	4¾	
Per dozen.....	\$6.00	7.50	
Weight per doz., lbs.....	3½	4	

Add to above list for long spouts \$0.25 per doz.
 Add to above list for bent spouts \$0.25 per doz.

One dozen in a box.

† Carried in San Francisco only.

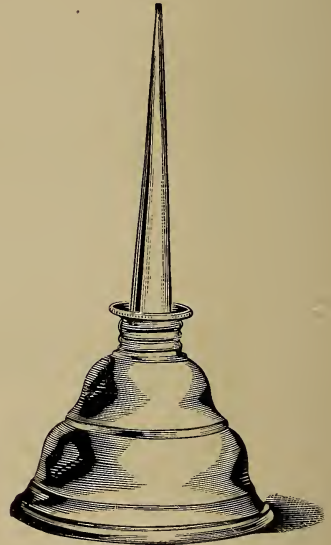

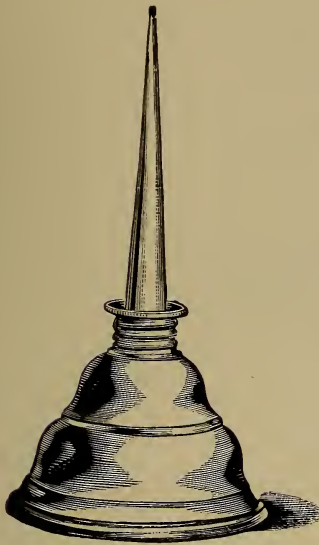

† **CHACE'S COPPER OILERS.**

SPRING BOTTOMS.

Code	Kuhaup	Kuhblat	Kuhdart
Numbers	2	3	4
Capacity	1¾ gills	½ pt.	¾ pt.
Diameter, inches	3¼	3¾	4½
Per dozen.....	\$3.75	4.25	5.00
Weight per doz., lbs.....	2	2¾	3¼
Code.....		Kuhfing	Kuhfeuss
Numbers		5	6
Capacity.....		1 pt.	1¼ pts.
Diameter, inches.....		4¾	4¾
Per dozen		\$6.25	8.00
Weight per doz., lbs.....		3½	4

Add to above list for long spouts \$0.25 per dozen.
 Add to above list for bent spouts \$0.25 per dozen.

One dozen in a box.

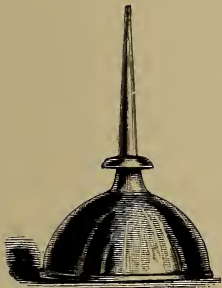

† **SEWING MACHINE OILERS.**

TIN.

Code	Kubglot
Per dozen.....	\$0.83
Weight per doz., lbs.....	¾

One dozen in a box.

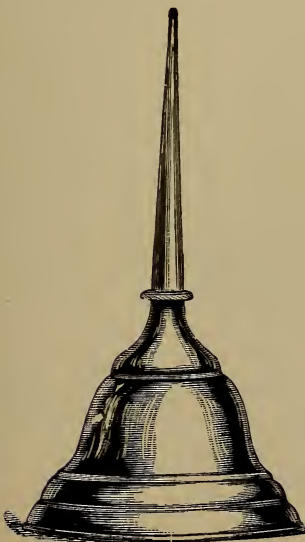

† **CHACE'S TIN OILERS.**

SPRING BRASS BOTTOMS.

Code	Kuhlans	Kuhmek	Kuhpock	Kuhschwar
Numbers	1	2	3	4
Capacity	¾ gill	1¾ gills	½ pt.	¾ pt.
Diameter, inches	2¾	3¼	3¾	4½
Per dozen.....	\$1.75	2.50	3.00	3.50
Weight per doz., lbs.	1¼	2	2¾	3¼

No. 1, one dozen in a box.

Nos. 2 to 4, one-half dozen in a box.

†Carried in San Francisco only.

† **FLAT-NOSE PLIERS.**

FORGED STEEL. POLISHED JAWS. BOX JOINTS.

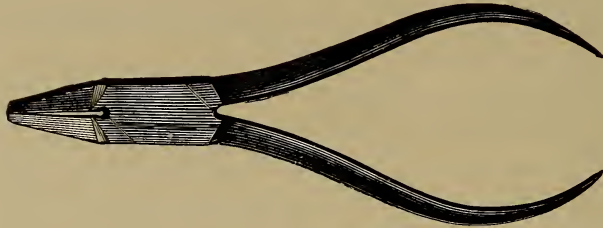

Code	Madurative	Maestro	Mafora	Magalibou
Inches.....	5	6	7	8
Per dozen.....	\$5.00	6.00	8.50	12.50
Weight per doz., lbs.....	1½	2½	4	6½

One-half dozen in a box.

† **ROUND-NOSE PLIERS.**

FORGED STEEL POLISHED JAWS. BOX JOINTS.

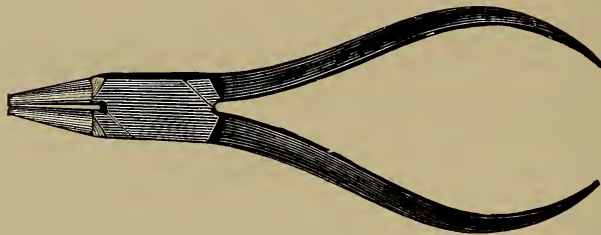

Code.....	Magazine	Magbush	Magdalene
Inches.....	5	6	7
Per dozen.....	\$5.00	6.00	8.50
Weight per doz., lbs.....	1½	2½	4

One-half dozen in a box.

COMBINATION PLIERS.

FORGED STEEL. GRIPPS FROM 3/16-INCH ROUND TO 1-INCH ROUND OR SQUARE.

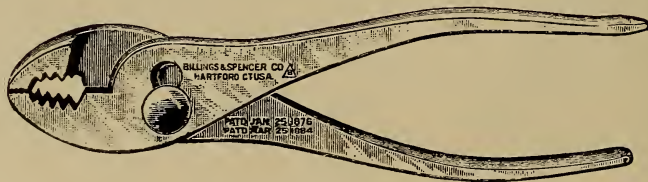

Code.....
Style.....	Polished	Nickel-plated
Length, inches.....	6	6
Per dozen.....	\$13.50	15.00
Weight per doz., lbs.....

† Carried in San Francisco only.

† **SIDE-CUTTING PLIERS.**

FORGED STEEL. POLISHED JAWS. RAISED CUTTERS. BOX JOINTS.



Code.....	Magenkranz	Magenkreb	Magenpent	Magedest
Inches.....	5	6	7	8
Per dozen.....	\$12.50	13.50	17.00	20.00
Weight per doz., lbs.....	1½	4	7	10

One-half dozen in a box.

† **BURNER PLIERS.**

CAST STEEL. NICKEL-PLATED.

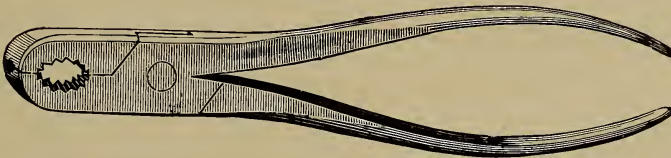

Code.....	Maggessand	Maggioli
Inches.....	5	6
Per dozen.....	\$9.25	10.50
Weight per doz., lbs.....	3¼	4½

One-half dozen in a box.

† **GAS PLIERS.**

CAST STEEL. NICKEL-PLATED.

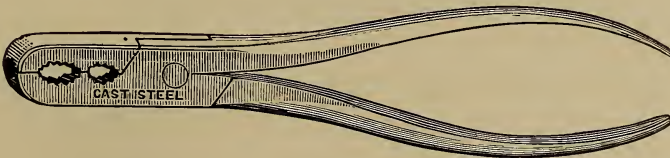

Code.....	Magistero
Inches.....	7
Per dozen.....	\$11.75
Weight per doz., lbs.....	5½

One-half dozen in a box.

† Carried in San Francisco only.

† **GAS PLIERS.**

CAST STEEL. POLISHED JAWS. BLACK HANDLES.

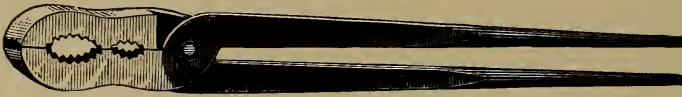

Code.....	Magistrad	Magnanimo	Magnatibo	Magneticus	Magnetist	Magnetoid	Magnifico
Inches	8	9	10	11	12	13	14
Per dozen.....	\$8.25	9.25	10.70	12.00	13.00	15.00	17.00
Weight per doz., lbs.....	6½	8	11	13	14	15	17

One-half dozen in a box.

† **BENDING PINS.**

STEEL. BOTH ENDS BENT.

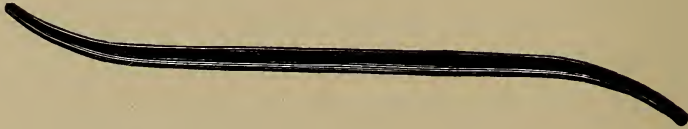

Code	Magnitate
Length, inches	13½
Per dozen	\$3.50
Weight per doz., lbs.....	12

Loose.

† **BLOW PIPES.**

POLISHED BRASS.

Code	Magofoni
Length, inches.....	10
Per dozen.....	\$4.50
Weight per doz., lbs.....	½

Loose.



UNIVERSAL SOIL PIPE PLUGS.

This Plug will fit light, heavy, or extra heavy pipe, and make a perfect joint. For Hub Ends one size larger than bore of pipe must be used.

Code	Magrapher	Maguntina	Mahaleba
Size, inches.....	2	3	4
Each	\$1.00	1.25	1.50
Weight each, lbs.
Code	Mahlband	Mahlgest	
Size, inches.....	† 5	† 6	
Each	\$2.00	2.50	
Weight each, lbs.....	8½	

Loose.



† Carried in San Francisco only.

†**DUPLEX TESTING PLUGS.**

MADE OF THE BEST MALLEABLE IRON AND GUARANTEED NOT TO BREAK. THE ONLY PLUG THAT WILL TEST A HOPPER TRAP.

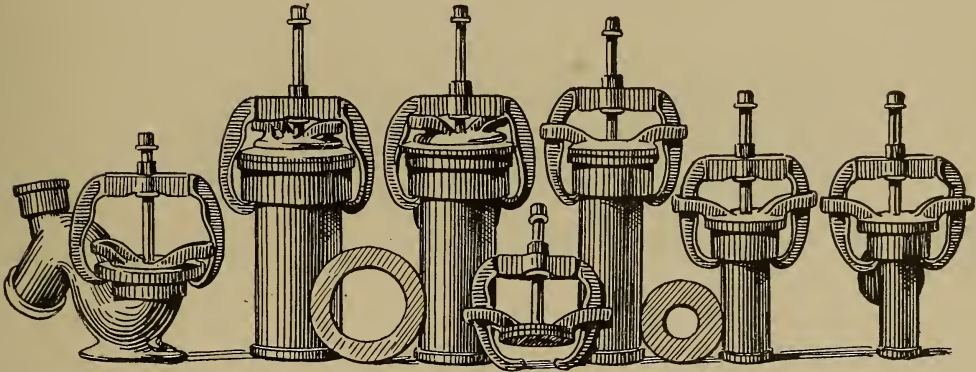

Cut Shows Plug Attached to Different Sizes of Pipe and Hopper Trap.

Every Plug will test 2, 3, and 4-in. Light and Extra Heavy Soil Pipe and Hopper Trap; and the same Plug with an extra Plate will Test 5 and 6-in. Soil Pipe.

Code.....	Mahlinst Plug	Mahljack Extra Plate
Each.....	\$2.50	\$2.00
Weight each, lbs.....	11	6

†Carried in San Francisco only.

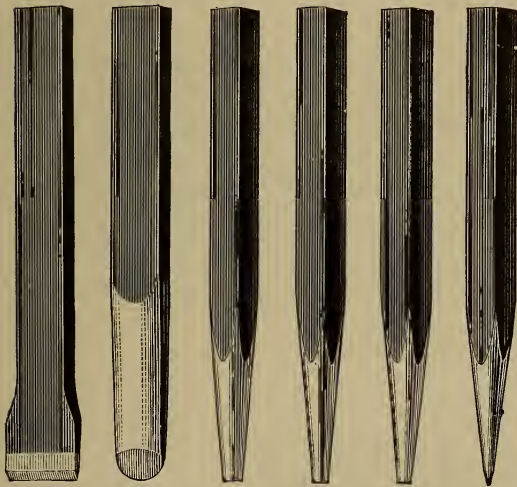

†**PUNCHES AND CHISELS.**

IN SETS.

Consist of 1 Prick Punch, 1 Wire Chisel, 3/4 inch; 1 Lantern Chisel, 1 Solid Punch each, Nos. 3, 4 and 5.

Code.....	Mahlzette
Per set.....	\$0.75
Weight per set, lb.....	1

One set in a box.

†**SOLID PUNCHES.**



Full size of Ends.



Nos. 0 1 2 3 4 5 6 7 8

Code.....	Mahomedan	Maiblum	Maibowl	Maidpole	Maigroot	Maileth	Maimed	Maimonate	Mainbower
Numbers.....	0	1	2	3	4	5	6	7	8
Inch.....	2/32	3/32	4/32	5/32	6/32	7/32	8/32	9/32	3/64
Each.....	\$0.12	.12	.12	.12	.12	.12	.12	.12	.12
Weight per doz., lbs.....	2	1 3/8	1 1/4	1 1/4	1 1/4	1 1/2	1 1/2	1	3/4

One dozen in a box.

†Carried in San Francisco only.

†RIVET SETS.

FORGED STEEL. POLISHED AND BLUED.

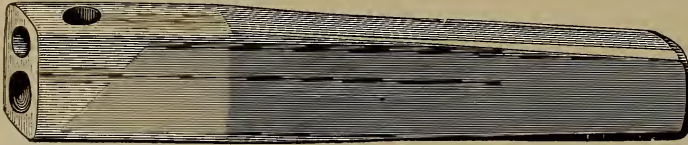

Full Size of Holes.

	Nos. 00	0	1	2	3	4	5	6	7	8
For iron rivets.....	14	10 and 12	8	6 4 and 5	2½ and 3	1¾ and 2	1½	1¼	lbs. 10 and 12 ozs.	
For copper rivets Nos.....	5	6	7	8	9	10 and 11	12	13	14	
Code.....	Mainmort	Maintenon	Majadora	Majestade	Majordomo	Majorist	Malacate	Malachior	Malacoder	Malagmati
Numbers ...	00	0	1	2	3	4	5	6	7	8
Each.....	\$0.75	.75	.63	.63	.50	.50	.37	.37	.32	.32
Wt. per doz., lbs.	10	10	7¼	4¾	4½	4	3	2½	2½	2½

One-half dozen in a box.

†PRICK PUNCHES.



Code.....	Malakane
Each.....	\$0.12
Weight per doz., lb.....	1

One dozen in a box.

†HOLLOW PUNCHES.

FORGED STEEL.

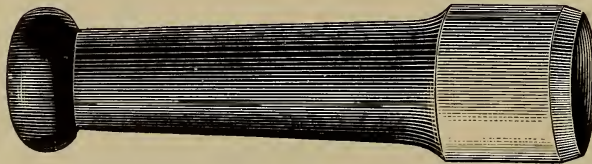

Code.....	Malandane	Malapert	Malavised	Malaxando	Malaxate	Malcopert	Maldecimo	Maldizent
Inches.....	¼	⅜	½	¾	¾	¾	1	1½
Each.....	\$0.25	.38	.50	.63	.75	.88	1.00	1.15
Weight per doz., lbs...	1	1½	3	4	5	7	9	15
Code.....	Maledixer	Malefacto	Maletine	Malifera	Malignor	Malleator	Malmond	
Inches.....	1¼	1¾	1½	1¾	2	2¼	2½	2¾
Each.....	\$1.25	1.38	1.50	1.75	2.50	2.82	3.13	3.44
Weight per doz., lbs.....	17	19	22	32	34	36	42	48

¼ to ½-inch, one dozen; ¾ to 1¼ inches, one-half dozen; 1½ to 2 inches, one-quarter dozen; 2¼ to 2¾ inches, one-twelfth dozen in a box.

†Carried in San Francisco only.

† **VANDERMAN'S ASBESTOS LEAD JOINT RUNNER.**

A SURE JOINT MAKER.

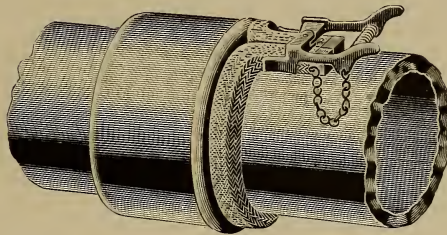

Cut shows Runner applied

This is a time saver for Plumbers, Water and Gas Companies. It is adapted for soil, water or gas pipes, or a bell pipe of any description where a joint is poured with moulten lead. Red hot lead does not affect it. Directions are sent with each runner.

Code.....	Malmunch	Malnedoc	Malnipud
Numbers.....	1	2	3
For pipe, inches.....	2 to 4	4 to 6	6 to 10
Each	\$1.25	1.50	2.25

† **TINNERS' RULES AND STRAIGHT EDGES.**

STEEL POLISHED. 16 GAUGE.

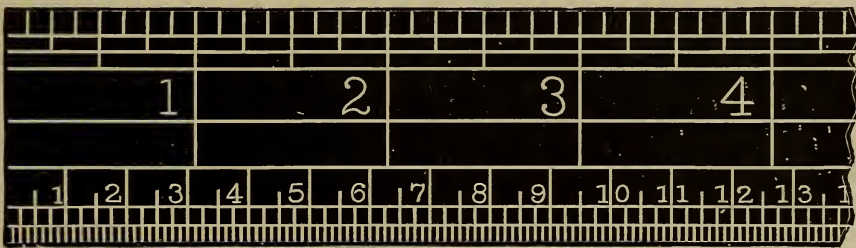

Section of Tinnners' Rule. Entire Length, One Yard. No. 101.

This Tinnners' Rule is an invaluable article for any practical tinner, and the cut is an exact representation so far as shown; its entire length is 36 inches. The upper line is the ordinary rule graduated by eighths of an inch. The lower line shows at a glance the exact circumference of any cylinder by simply ascertaining the diameter, *i. e.*, a vessel 5 inches in diameter the rule indicates to be 15¾ inches in circumference.

The reverse side contains much useful information in large, plain figures, regarding the sizes of sixty different articles, such as cans, measures, pails, etc., with straight or flaring sides, flat or pitched top, liquid and dry measure in quarts, gallons and bushels. First is given the dimensions for vessels holding 1 to 5 gallons, liquid measure; second, ¼ to 2 bushels, dry measure; third, cans with pitched top, 1 to 10 gallons; fourth, cans with flat top, 1 to 200 gallons; fifth, vessels holding 1 to 8 quarts and ½ bushel to 3 bushels, dry measure.

Code.....	Malpardi	Malpensate
Numbers.....	76	101
Each.....	\$1.00	3.50
Weight each, lbs.....	¼

No. 76 is a folding steel rule, 24 inches long, for pocket use. One side is graduated by sixteenths; on the other side, one edge is graduated by eighths, the other edge has circumference graduations.

Each Rule in a leather case.

† Carried in San Francisco only.

† **COMPASS SAWS.**

CAST STEEL. BEECH HANDLES.

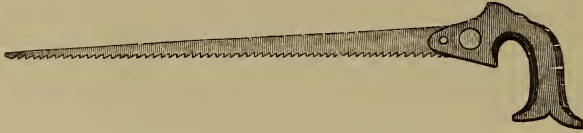

Code	Malproper	Malquista	Malsano
Length, inches	10	12	14
Per dozen	\$1.25	4.50	4.75
Weight per doz., lbs	5	5½	6

One-half dozen in a box.

† **DOUBLE EDGE SAWS.**

THREE SCREW. CAST STEEL. BEECH HANDLES.

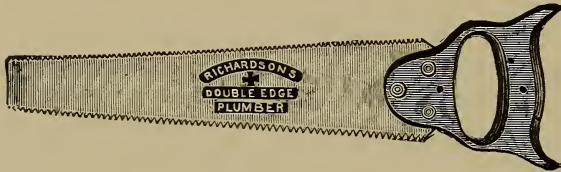

Code	Malsicurd	Malstick
Length, inches	16	18
Per dozen	\$9.00	10.00
Weight per doz., lbs	9	9½

One-third dozen in a box.

† **SINGLE EDGE SAWS.**

CAST STEEL. BEECH HANDLES.

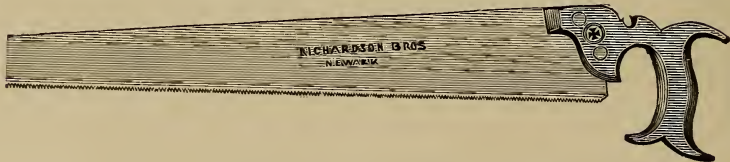

Code	Maltalent	Maltermate	Malthusia
Length, inches	14	16	18
Per dozen	\$7.00	8.00	9.00
Weight per doz., lbs	7½	8½	9

One-third dozen in a box.

† Carried in San Francisco only.

STAR HACK SAW FRAME.

CAST IRON. JAPAN FINISH.



This frame is so constructed as to face blades in four different directions.

The pins are fast in the frame and cannot drop out. It is a very stiff and desirable frame for 9-inch blades.

Code	Maltibe
Number	4 B
Per dozen	\$3.00
Weight, per dozen, lbs	15

One-half dozen in a box.

STAR EXTENSION HACK SAW FRAME.

TEMPERED STEEL. POLISHED AND NICKEL-PLATED. COCOBOLO HANDLE.

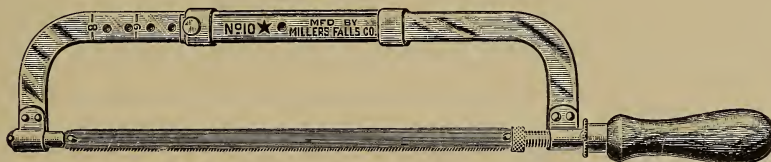

The best extension frame on the market. It is light and quickly adjusted, having strength in the middle where strength is needed. Adjustable and marked for blades from 6 to 12 inches. The method of straining the blades by simply turning the handle is an improvement over the winged nut.

Note the ring which turns down over the ends of the blades and prevents the latter from falling off the pin when adjusting.

Code	Maltick
Number	10
Per dozen	\$12.00
Weight, per dozen, lbs	15

One-twelfth dozen in a box.

HACK SAW BLADES

TEMPERED STEEL. PATENT SET. 24 TEETH TO THE INCH.



Code	Maltidle	Maltiff	Maltigue	Maltill	Maltism
Inches	8	9	10	11	12
Per dozen	\$0.65	.70	.85	.95	1.05
Weight, per dozen, lbs	¼	⅜	½	½	½

One dozen in a package. Six dozen in a box.

† **MENLO TINNERS' SHEARS OR SNIPS.**

FORGED STEEL. TEMPERED AND HARDENED. BLACK JAPANNED HANDLES.

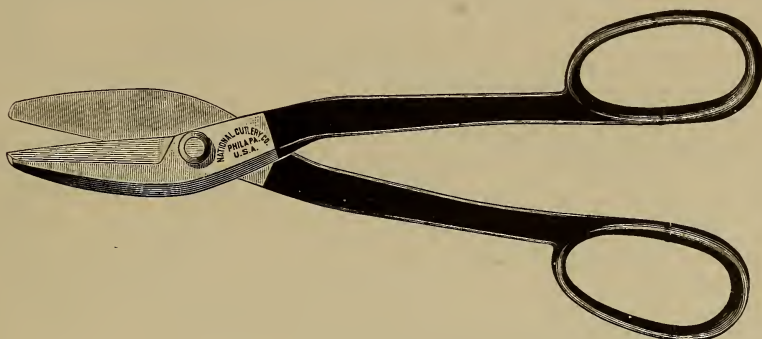

Code.....	Maltornite	Maltsters	Mambrino	Mamilare	Mamposter
Numbers.....	6½	7	8	9	10
Full length, inches.....	15	14¼	13	11¾	10
Length of cut, inches.....	4½	4	3½	3	2½
Per pair.....	\$3.00	2.50	2.00	1.50	1.40
Weight per pair, lbs.....	4	3	2½	2	1½

Two pair in a package.

† **MENLO TINNERS' SHEARS OR SNIPS.**

FORGED STEEL. TEMPERED AND HARDENED. BLACK JAPANNED HANDLES. FOR CUTTING CIRCLES, IRREGULAR AND STRAIGHT LINES.

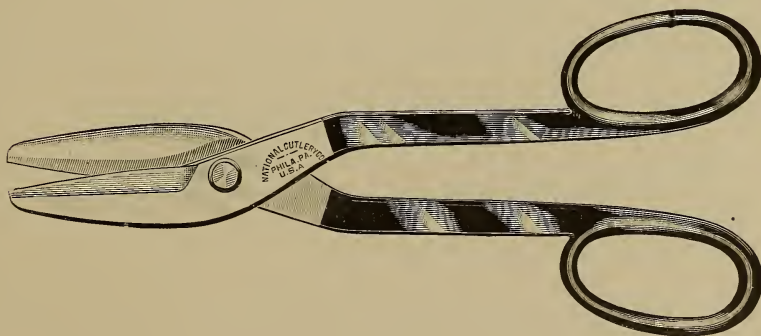

Code	Mamselle	Manacht	Manacled
Numbers	17	18	19
Full length, inches.....	14¼	13	11¾
Length of cut, inches	4	3½	3
Per pair ..	\$2.50	2.00	1.50
Weight per pair, lbs.....	3	2½	2

Two pairs in a package.

† Carried in San Francisco only.

† **“LYON” SHEARS OR SNIPS.**

FORGED HANDLES. STEEL BLADES. FOR CUTTING SCROLLS AND CIRCLES.

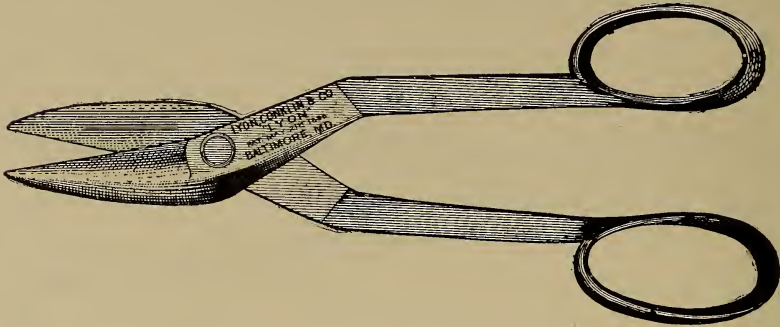

Code.....	Manalgic	Manamino	Manastaba	Manbind
Numbers.....	165	170	180	190
Length of cut, inches.....	4½	4	3½	3
Per pair.....	\$3.00	2.50	2.00	1.50
Weight per pair, lbs.....	3	2½	2	1½

One pair in a package.

† **P. S. & W. CO. TINNERS' SHEARS AND SNIPS.**

LEFT HAND.

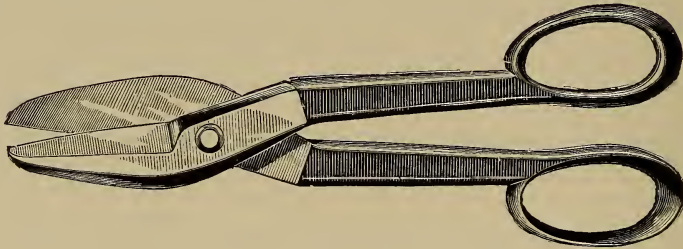

We sometimes have call for Snips for left handed men, but a left hand Snip, as we apply the term, is not intended for a left-handed man.

Confusion often arises as to the meaning of the terms right and left hand, as applied to Snips. Right hand are made like Bench Shears, and left hand opposite. That is, when held in the right hand the lower blade is on the right side of the Shears in right hand Shears, and on the left hand in left hand Shears. Left hand only are shown in the cuts. Left hand Snips are more generally used, and are invariably sent unless right hand are ordered.

All Snips stamped "P. S. & W. Co." are of the highest grade of excellence and fully warranted.

Code.....	Manchart	Manchman	Mancinos	Mancipibo	Mancorne	Mandalot
Numbers.....	6½	7	8	9	10	11
Length of cut, inches.....	4½	4	3½	3	2½	2
Per pair.....	\$3.00	2.50	2.00	1.50	1.40	1.25
Weight per pair, lbs.....	3	2½	2	1½	1	½

One pair in a package.

† **Right Hand Snips.**

Code.....	Mandamus
Number.....	8
Length of cut, inches.....	3½
Per pair.....	\$3.00

Extra Bolts and Nuts for Shears and Snips Each, \$0.20

† Carried in San Francisco only.

† **P. S. & W. CO. TINNERS' SHEARS AND SNIPS.**

GERMAN PATTERN. WITH WIRE CUTTER.

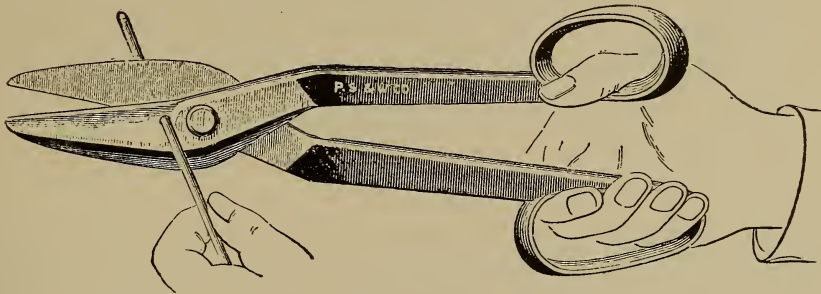

Code	Mandarine	Mandate	Mandatori	Mandelkort
Numbers	2	3	4	5
Length of cut, inches.....	4	3½	3¼	3
Per pair	\$2.50	2.00	1.75	1.50
Weight per pair, lbs.....	2¾	2¼	2	1½

One pair in a package.

† **P. S. & W. CO. CIRCULAR SHEARS OR SNIPS.**

BEST QUALITY.

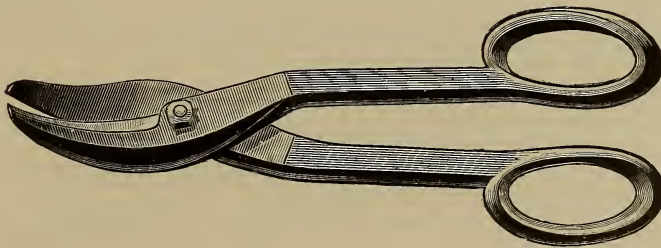

Code.....	Mandelzag	Mandibule	Mandrigo	Mandrillo
Numbers	7	8	9	10
Per pair.....	\$3.50	3.00	2.50	2.25
Weight per pair, lbs.....	2½	2	1½	1

One pair in a package.

Extra Bolts and Nuts for Circular Shears or Snips.....Each, \$0.20

† Carried in San Francisco only.

† **P. S. & W. CO. HAWK'S BILL SHEARS.**

BEST QUALITY.

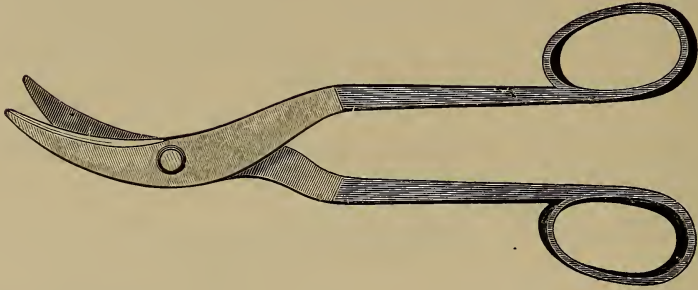

The above cut represents a Curved Shear of real worth and great merit. It is capable of cutting in sheet metal openings of any kind and shape. Letters are easily cut out from sheet metal. They are especially adapted for cutting off the bottoms of metal vessels and for cutting openings in pipes or cylinders of every description, for furnace jackets, thimbles, tee joints, etc. A bottom can be cut from a pint cup or a copper boiler with equal ease.

Code.....	Mandrocle
Number	15
Per pair.....	\$3.00
Weight per pair, lb.....	1

One pair in a package.

† **BLUMER'S COMBINATION PIPE FITTER.**

FOR SHEET METAL WORK OF ALL KINDS.

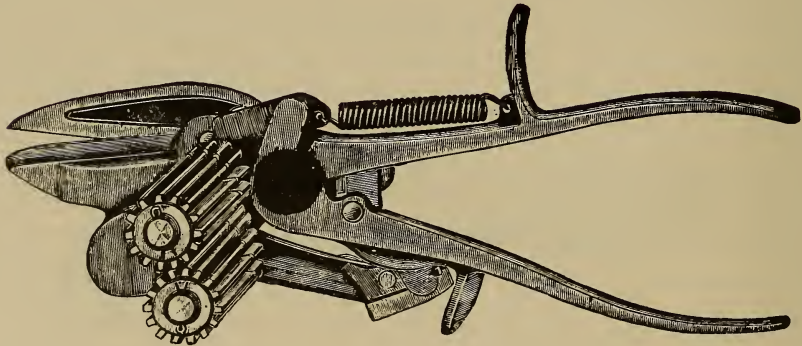

The combination of a shear and Rotary Hand Crimper will be found serviceable in sheet metal work of all kinds. It will make a 1-inch crimp on metal as heavy as No. 24 gauge, and will cut metal as heavy as No. 18 gauge.

All working parts are made of steel and duplicate parts can be furnished.

Code	Mangarose
Length, inches.....	10
Per pair	\$3.50
Weight per pair, lbs	2

† Carried in San Francisco only.

† **DOUBLE-CUTTING SHEARS AND PIPE CRIMPERS.**

BEST QUALITY.



These double-cutting Shears combined with a Pipe Crimper are now well known. The blade is pointed and readily inserted in the metal at the point desired to begin the cutting. They are adapted to cutting off the bottoms of pails, cans, etc., and suitable for cutting round or square work. The crimping attachment is designed for crimping any kind of sheet metal pipe, round or square. The parts are interchangeable and the crimping jaws are of steel.

Code.....	Manfreed
Number	2
Length, inches.....	13
Per pair	\$3.00
Weight per pair, lbs.	2

One pair in a package.

† **DOUBLE-CUTTING SHEARS.**

BEST QUALITY.

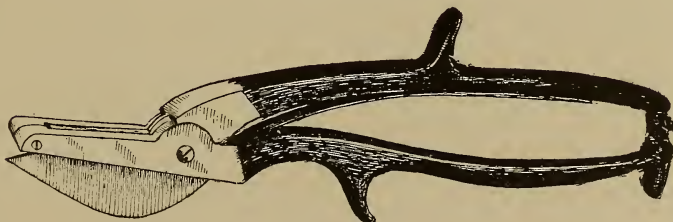

These double-cutting shears are the same as a Number 2, except that they have no crimping attachment and are made porportionately lighter.

Code	Mangapir
Number	1
Length, inches.....	8
Per pair	\$2.50
Weight per pair, lbs.....	¾

One pair in a package.

† Carried in San Francisco only.

†**PACKHAM CRIMPING TONGS.**

BLACK JAPANED.

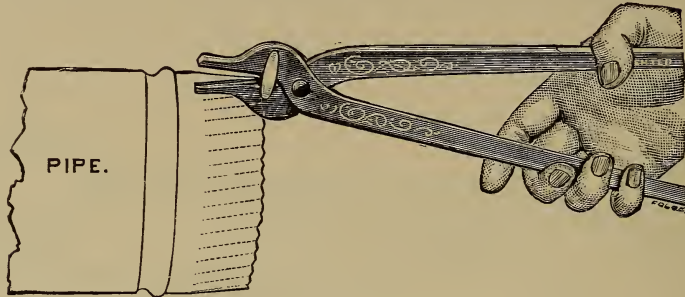

Code	Manganue
Length, inches	13½
Per pair.....	\$0.75
Weight per pair, lbs.....	1

One pair in a package.

†**TINNERS' BENCH SHEARS.**

FORGED STEEL.

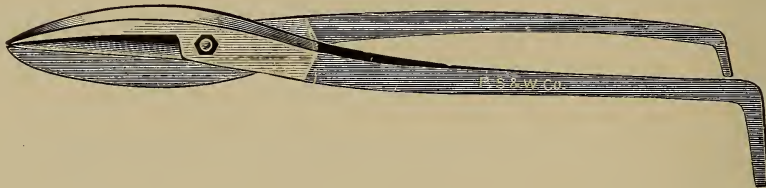

Code	Mangatori	Mangedour	Mangimel	Mangobam	Mangonite	Mangostan	Manifesto	Manigraph
Numbers.....	00	0	1	2	3	4	5	6
Length of cut, inches.....	12	10½	9	8¾	8¾	8	7	6
Per pair.....	\$13.50	12.00	8.00	7.00	6.00	5.00	4.00	3.50
Weight per pair, lbs.....	37	28	22	18	13	11	9	7

One pair in a package.

†**TINNERS' ELBOW BENCH SHEARS.**

BEST QUALITY FORGED STEEL.

Code	Manilargo	Manipolar
Style.....	Regular	Extra Heavy
Length of cut, inches.....	4	6
Per pair.....	\$5.25	12.00
Weight per pair, lbs	13	25

One pair in a package.

†**BOLTS AND NUTS FOR BENCH SHEARS.**

Code	Manipomel
Each for all sizes	\$0.25

†Carried in San Francisco only.

OSTER PIPE THREADING MACHINES.

WITH PATENT EXPANDING DIE HEADS.

Adjustable to variations in fittings. Vise centers pipe accurately.

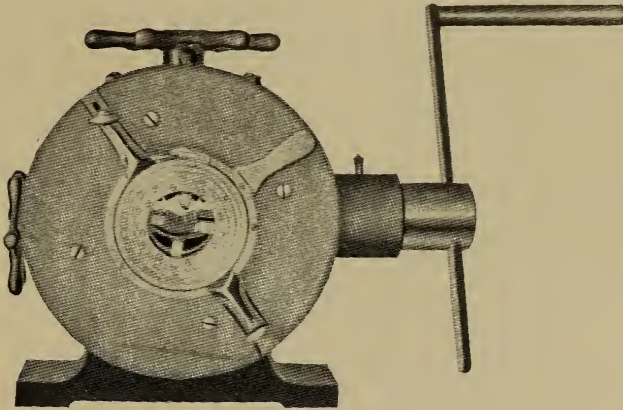

Cut shows No. 200 Hand Machine.

Code.....	Melodope
Number.....	200
Threads pipe, inches.....	$\frac{1}{4}$, $\frac{3}{8}$, $\frac{1}{2}$, $\frac{3}{4}$, 1, $1\frac{1}{4}$, $1\frac{1}{2}$, 2
Complete with 4 sets of R. H. dies.....	\$60.00
Oil reservoir, extra	3.00
Extra R. or L. H. dies (per set of 4 pieces)	3.00
Shipping weight, lbs.	225
Shipping measurement, cubic feet	$5\frac{1}{2}$

Each set of dies threads two sizes of pipe, viz: $\frac{1}{4}$ and $\frac{3}{8}$, $\frac{1}{2}$ and $\frac{3}{4}$, 1 and $1\frac{1}{4}$, $1\frac{1}{2}$ and 2.

This machine is not equipped with a cutting-off attachment.

OSTER PIPE THREADING MACHINE, No. 200A.

A POWER MACHINE.

The above cut of No. 200 represents this machine, except that a cone pulley is attached in place of the crank.

Code.....	Melodopull
Number.....	200 A
Threads pipe, inches	$\frac{1}{4}$, $\frac{3}{8}$, $\frac{1}{2}$, $\frac{3}{4}$, $1\frac{1}{4}$, $1\frac{1}{2}$, 2
Complete with 4 sets of R. H. dies, counter-shaft and cone pulley.....	\$100.00
Oil reservoir, extra.....	3.00
Extra R. or L. H. dies (per set of 4 pieces).....	3.00
Shipping weight, lbs.....	450
Shipping measurement, cubic feet.....	$12\frac{1}{4}$

Each set of dies threads two sizes of pipe. Speed of counter-shaft, 100 revolutions per minute. Diameter of tight and loose pulleys, 16 inches.

This machine is not equipped with a cutting-off attachment.

OSTER PIPE CUTTING AND THREADING MACHINES.

WITH EXPANDING DIE HEADS. AN AUTOMATIC CUTTING-OFF DEVICE.

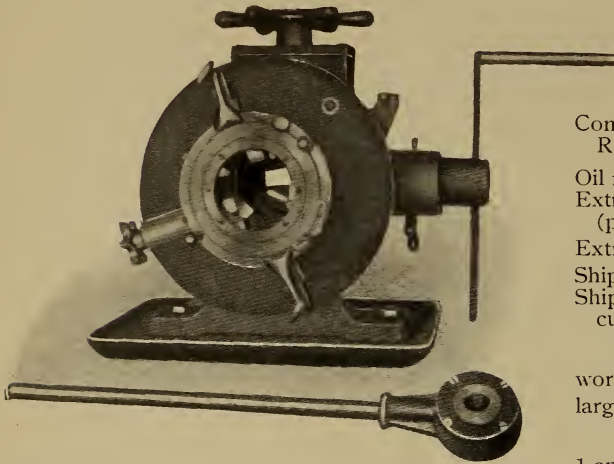

Cut shows No. 203 Hand Machine with Oil Reservoir.

Code	Melodoque
Number	203
Cuts and threads pipe, inches	1, 1¼, 1½, 2, 2½, 3, 3½, 4
Complete with 4 sets of R. H. dies and 2 cranks.	\$125.00
Oil reservoir, extra.....	3.00
Extra R. or L. H. dies (per set of 4 pieces)...	4.00
Extra cutter knives, each	1.50
Shipping weight, lbs.....	500
Shipping measurement, cubic feet.....	11

This machine is furnished with a crank for working small pipe, and ratchet attachment for large pipe.

Each set of dies threads two sizes of pipe, viz: 1 and 1¼, 1½ and 2, 2½ and 3, 3½ and 4.

203A POWER MACHINE.

Is equipped with automatic oil pump, that lifts the oil from a reservoir within the base and floods the cutters, the oil returning to the reservoir through a strainer.

A ratchet attachment is fixed permanently on these machines, making it possible to operate it by hand without change of equipment.

All gears are protected by guards.

Each machine has an adjustable, swiveled tripod on which to rest the pipe.

Each set of dies threads two sizes of pipe, viz: 1 and 1¼, 1½ and 2, 2½ and 3, 3½ and 4.

Speed of counter-shaft, 120 revolutions per minute.

Diameter of tight and loose pulleys on counter-shaft, 14 inches.

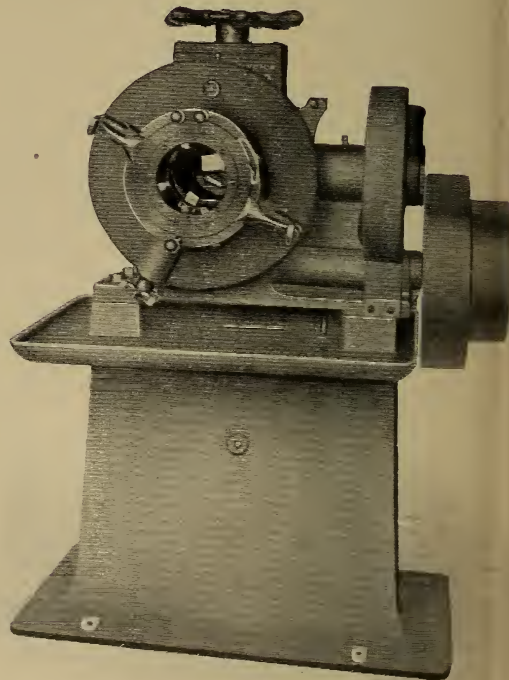

Cut shows No. 203A Power Machine.

Code.....	Melodorail
Number.....	203 A
Cuts and threads pipe, inches.....	1, 1¼, 1½, 2, 2½, 3, 3½, 4
Complete with 4 sets of R. H. dies, base, oil pump, cutting-off device, counter-shaft and tripod	\$260.00
Extra R. or L. H. dies (per set of 4 pieces).....	4 00
Extra cutter knives, each.....	1.50
Shipping weight, lbs.....	1100
Shipping measurement, cubic feet.....	35½

OSTER PIPE CUTTING AND THREADING MACHINE.

WITH EXPANDING DIE HEADS AND AUTOMATIC CUTTING-OFF DEVICE.

FOR 1 INCH TO 6 INCH PIPE.

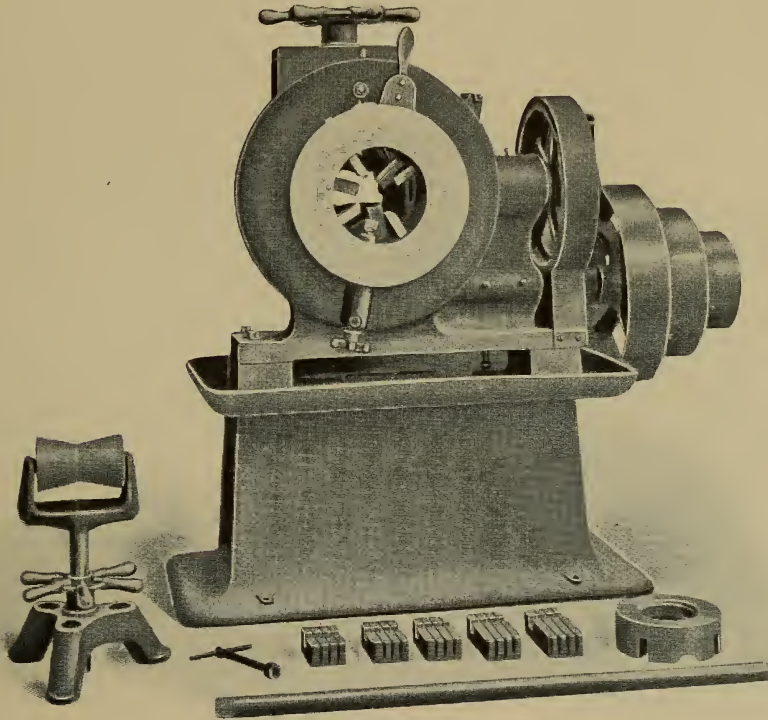

The Die Head is a quick opening and closing device, instantly adjustable to variations in setting. Dies can be inserted or removed through the shell of the head and die slots can be cleaned without taking the die heads apart.

The Setting Lever is a principal feature of this machine. It is used in releasing and setting the dies.

Base is cast in one piece and contains the oil reservoir, which can be drained by removing a plug.

Gears are all machine cut and entirely protected from chips or accident. All pinions are cut from solid steel forgings.

The Adjustable Guides which are placed just back of the dies, center and hold the pipe in place while cutting off. One set of guides adjusts to all sizes of pipe.

Cutting-Off Attachment is operated automatically by means of pawl attached to side of machine and is practically an indestructible lathe tool, making a clean cut without burr. The cutter can be removed easily and sharpened on an ordinary grindstone.

Pump is driven by gears. It works while threading left hand as well as right hand.

Ratchet Attachment is permanently fixed on machine, by means of which the machine can be operated by hand without change of equipment.

Vise is self-centering and has gripping jaws of tempered tool steel.

Cone Pulleys have three steps, 10, 14 and 16 inches diameter for 3½-inch belt.

The Counter Shaft has tight and loose pulleys 16 inches diameter for a 4-inch belt and should be driven 120 revolutions per minute.

Tripod. An adjustable, swiveled tripod on which to rest the pipe is furnished with each machine.

Code	Melodoruse
Number.....	206 A
Complete with 6 sets of R. H. dies, 1 and 1¼, 1½ and 2, 2½ and 3, 3½ and 4, 4½ and 5 and 6 in.	\$400.00
Extra R. or L. H. dies (per set of 4 pieces).....	5.00
Shipping weight, lbs.....	1500
Shipping measurement, cubic feet.....	41¼

BIGNAL & KEELER PIPE THREADING MACHINE.

NO. 2 IMPROVED THREADING AND CUTTING-OFF MACHINE.

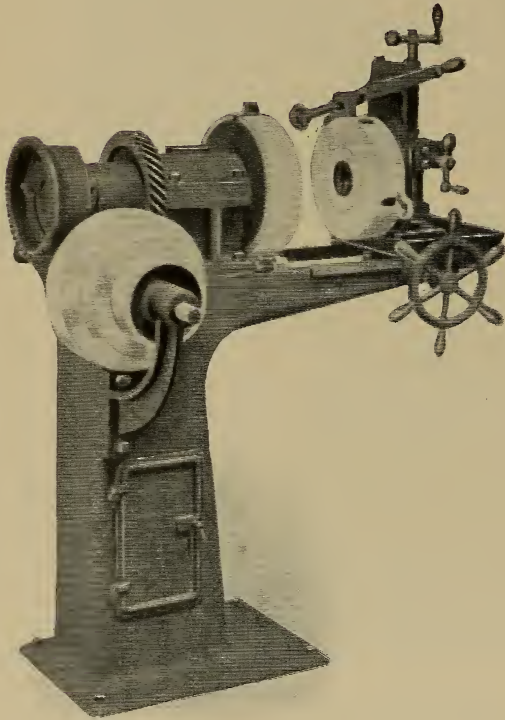

This machine is designed to meet the demand for a good, strong, quick-acting pipe-threading machine at a reasonable price. It will cut and thread all sizes of pipe from 1/4 to 2 inches. The bed is long and travel of carriage ample. The chuck is of the universal type and very strong.

Pipe Dies from 1/4 to 2-inch are included in the regular equipment, and L. H. dies can be furnished extra. Each set of dies consists of four chasers and will cut two sizes without changing dies.

A Two-Jaw Universal Chuck is placed on the front end of the arbor for gripping and a self-centering scroll chuck on the rear for supporting and bringing the pipe in line with the dies. This scroll is provided with a knarled rim so that pins and wrenches are not needed.

The Gears are all machine cut from the solid, a feature not found on any other tool of this class and price; besides the main drive is a set of cut spiral gears, very powerful and smooth running. With a set of compound shift gears and a three-step cone pulley, six speeds are obtained, three more than usually found on small tools, and all run in oil completely enclosed but easy to get at for repairs.

The Peerless Die Head and Expanding Dies enables the operator to run the carriage forward or backward as required, without backing out the pipe, which would be necessary with the solid dies. No extra tools are needed in this operation, and no part of the head is removed in changing the dies. One movement of the lever expands the dies and the carriage can be run back.

Cutting-Off Tool and Steady Slides are always in position for use.

An Automatic Oil Pump is placed on each machine, and is outside so that access to piping and plunger is had very readily.

The Bearings are large and well babbitted and all wearing surfaces are large and accurately fitted.

Hand or Belt Power can be used. We furnish a counter-shaft with tight and loose pulleys. Counter-shaft should run 225 revolutions per minute. Diameter of pulley on counter-shaft, 12 inches; width of face, 3 inches.

Code	Melodosa	Melodaset
Number.....	2 for Hand Power	2 for Belt Power
Complete with R. H. pipe dies from 1/4 to 2-inch.....	\$110.00	125.00
Shipping weight, lbs.....	700	700

Extreme floor space required, 24x36 inches.

**P. D. Q. C. NO. 2 IMPROVED PIPE CUTTING AND
THREADING MACHINE.**

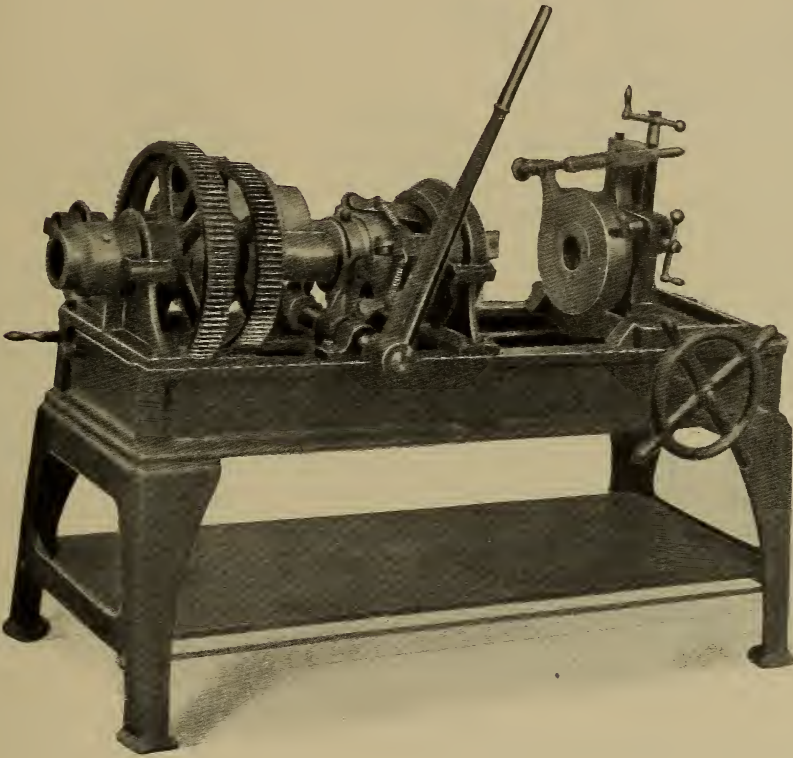

This machine was designed especially to meet the demand from Tube Mills, Car Shops and Supply Houses, where large quantities of pipe are cut and threaded. No material has been spared to make it strong in every part. It is convenient, and being equipped with the Peerless Adjustable Die Mechanism and Gripping Chuck of the lever type, a greater amount of work can be accomplished than is possible with any other machine.

The chuck jaws are held in T slots in the short ends of the lever, and adjusted by means of special case hardened screws. They are made of tempered steel, with teeth of M form, and can be easily sharpened without drawing the temper.

All the gears are machine cut from the solid, assuring practically noiseless and steady working.

The dies and cutting off tool are supplied with a constant stream of oil from an automatic oil pump.

Code.....	Melodotte
Machine complete with one set each (4 pieces to the set), adjustable expanding R. H. dies for 1¼ to 2-inch pipe, counter-shaft and wrench.....	\$430.00
Machine complete, for pipe and nipples, same equipment as above and one set each (4 pieces to the set) R. H. sectional holders from ¼ to 2-inch, nipples.....	575.00
Extra dies, R. or L. H. (per set of 4 pieces).....	8.00
Extra nipple holders (per set of 4 pieces).....	18.00
Extra cutter knives, each.....	.50

Speed of counter-shaft should be 200 revolutions per minute. Size of loose pulleys, 7-inch face and 14 inches diameter; tight pulleys, 3-inch face and 14 inches diameter. Distance between die head and chuck, 18 inches. Number of speeds, 6.

Extreme floor space required, 36x70 inches. Shipping weight, 1800 pounds.

DUPLEX NO. 6 IMPROVED PIPE CUTTING AND THREADING MACHINE.

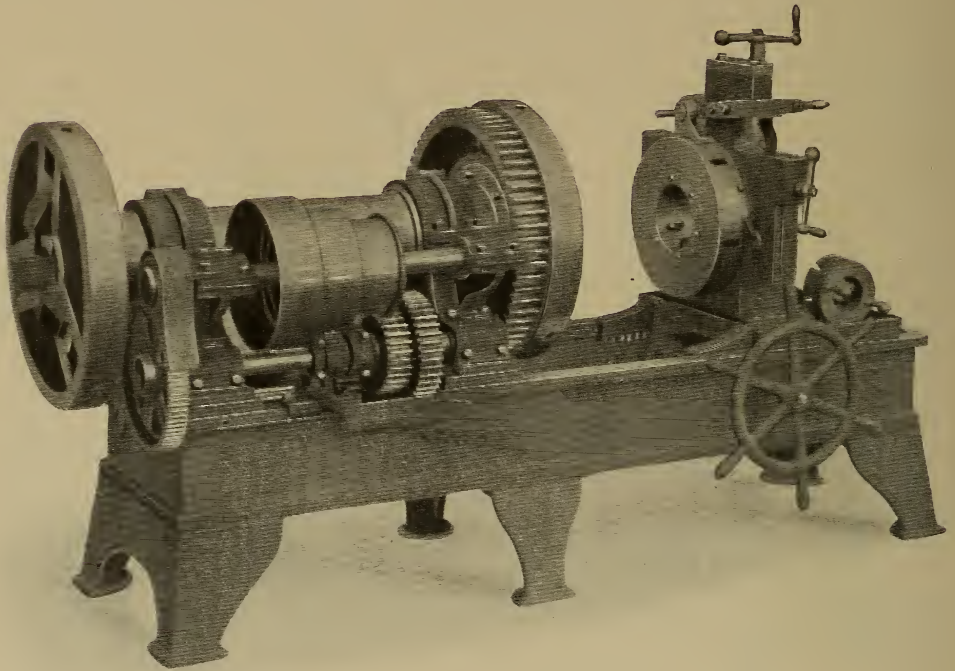

Strength, durability and compactness are essential features in any well designed machine, and the No. 6 Duplex Improved is unequalled in this respect. In appearance it is up-to-date, in workmanship first-class, and in material the best the market affords.

This machine is equipped with two chucks, one on each end of the arbor, that are identical with the exception that the jaws on the rear chuck are furnished with a set of grippers on the outside, which will be found very convenient in making up pipe, as the fittings can be screwed up from either end. Each jaw of these chucks is independent and graduated, so that there is no time lost in centering the pipe, as the jaws can be set to their respective sizes.

The Peerless Die mechanism on this machine is one of the features well worth considering, as it is fastened to the die stand, and there are no heavy parts to remove in changing the dies. By revolving the cam ring toward the right the numbered holes are placed directly above the dies and with a slight pressure the dies can be removed and quickly replaced by another set.

Each machine is equipped with an automatic oil pump, which keeps the dies and cutting knife well flushed with oil.

Code	Melodoure
Machine complete with one set each (6 pieces to the set), adjustable expanding R. H. dies for 1¼ to 6-inch pipe, counter-shaft and wrench.....	\$1000.00
Machine as above described, with engine drive, less counter-shaft, complete.....	1100.00
Extra dies, R. or L. H., for pipe or casing (per set of 6 pieces).....	15.00
Extra cutting knives, each.....	.75

Speed of counter-shaft should be 250 revolutions per minute. Size of loose pulley, 8-inch face and 16-inch diameter. Size of tight pulleys, 4-inch face and 16-inch diameter. Distance between die head and chuck, 26¾ inches.

Extreme floor space required, 37x96 inches. Shipping weight, 3850 pounds.

IMPROVED "DUPLEX" PIPE STOCKS AND DIES.

Hart's Patent.

RIGHT HAND DIES. BOTH GUIDES AND DIES INSTANTLY ADJUSTABLE.



Cut shows style of Nos. 2, 3 and 3½.

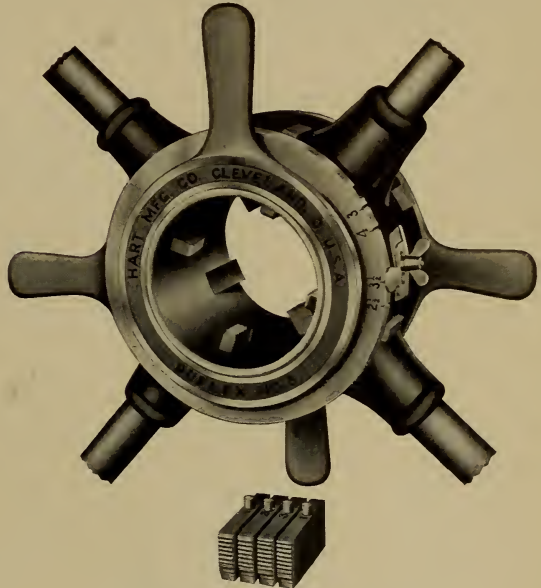

Cut shows style of Nos. 4 and 5.

Without Cut-Off.

Code.....	Mannabred	Mannerist	Mannikin
Numbers.....	2	3	3½
Pipe sizes each tool will thread and cut, inches.....	¼, ⅜, ½, ¾, 1, 1¼	1, 1¼, 1½, 2	½, ¾, 1, 1¼, 1½, 2
Each complete.....	\$17.00	22.00	25.00
Weight each, lbs.....	20	25	26
Shipping measurement, cubic feet.....	⅜	½	½

With Cut-Off.

Code.....	Mantecado	Mantedore	Manteleri	Manterose
Numbers.....	3	3½	4	†5
Each.....	\$25.00	28.00	45.00	60.00
Weight each, lbs.....	26	27	58	72
Shipping measurement, cubic feet.....	½	½	1½	1½

One in a case.

Will be sent with Cut-off unless otherwise ordered.

Extra Dies. Right Hand.

Numbers.....	2	3	3½	4	†5
Weight per set of four, ounces	13	14	14	27	33

Sizes Each Set Cuts, Inches.	Code.	Per Set.	Code.	Per Set.	Code.	Per Set.	Code.	Per Set.	Code.	Per Set.
¼ and ⅜.....	Mauraudon...	\$1.75								
½ and ¾.....	Marcadoir....	1.75			Mardoche.....	\$2.00				
1 and 1¼.....	Marchama ...	1.75			Marchesa.....	\$2.00				
1½ and 2.....					Marcidulo....	2.00			Maribond.....	\$3.50
2½ and 3.....									Maridant....	3.50
3½ and 4.....									Marimoren...	\$4.00
									Mariolate....	4.00

Left Hand Dies can be furnished at same price as Right Hand Dies.

†Extra Knives or Cut-Off Tools.

Code.....	Maritorne	Marketer	Marline	Marmardet	Marmarzum	Marmell
Numbers.....	3	3½	4	5	8	9
Each.....	\$0.40	.40	.50	.50	.50	.75

†Carried in San Francisco only.

† DUPLEX RATCHET DIE STOCKS AND DIES WITH CUT-OFF.

Hart's patent.

WITH RIGHT HAND DIES AND CUT-OFF.

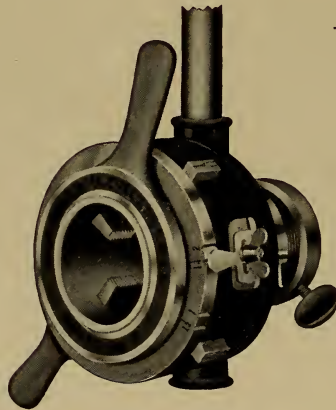

Code	Mascottot	Mascate
Numbers.....	8	9
Pipe sizes each tool will thread and cut, inches.....	1, 1¼, 1½, 2	2½, 3, 3½, 4
Each.....	\$28.00	65.00
Weight each, lbs.....	33	84
Shipping measurement, cubic feet.....	⅝	1

One in a case.

† Extra Dies. Right Hand.

Numbers.....	8	9
Weight per set, ounces.....	14	33

Sizes Each Set Cuts, Inches.	Code.	Per Set.	Code.	Per Set.
1 and 1¼.....	Masturt.....	\$2.00		
1½ and 2.....	Masuroll.....	2.00		
2½ and 3.....			Matabuzz.....	\$4.00
3½ and 4.....			Matacolon.....	4.00

Left Hand Dies can be furnished at same price as Right Hand Dies.

† Carried in San Francisco only.

ARMSTRONG'S ADJUSTABLE STOCKS AND DIES.

WITH RIGHT HAND DIES, FOR THREADING PIPE.

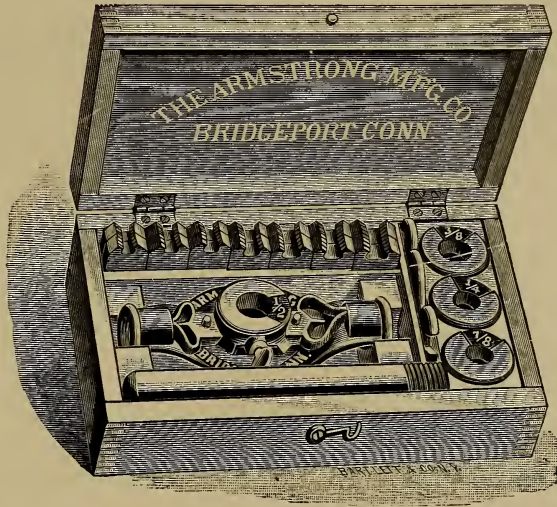

Code.....	Matadour	Matahhmo
Numbers.....	2	3
Pipe sizes of dies, inches.....	¼, ⅜, ½, ¾, 1	1, 1¼, 1¾, 2
Each.....	\$12.00	24.00
Weight each, lbs.....	17	40

One set in a box.

† Right and Left Hand Extra Dies. No. 2 Stock.

Code, right hand.....	Mataperro	Matavondu	Matenmake	Matercule	Maternida	Maternote
Code, left hand.....	Mathanid	Matigend	Matilicad	Maticor	Matizado	Matlock
Inch.....	⅛	¼	⅜	½	¾	1
Per set.....	\$1.50	1.50	1.50	1.50	1.50	1.50

† Right and Left Hand Extra Dies. No. 3 Stock.

Code, right hand.....	Matarcurd	Matricart	Matrimode	Matronal
Code, left hand.....	Matserve	Matshame	Mattamost	Mattenborn
Inches.....	1	1¼	1½	2
Per set.....	\$4.00	4.00	4.00	4.00

† Extra Bushings. No. 2 Stock.

Code.....	Mattgelt	Matulare	Maturame	Maturando	Maudiron	Maudisson
Inch.....	⅛	¼	⅜	½	¾	1
Each.....	\$0.25	.25	.25	.25	.25	.25

† Extra Bushings. No. 3 Stock.

Code.....	Mauerbrut	Mauerkron	Mauerspat	Maugrape
Inches.....	1	1¼	1½	2
Each.....	\$0.50	.50	.50	.50

† Carried in San Francisco only.

† **“HOLLAND’S” PIPE STOCKS AND DIES.**

WITH RIGHT HAND DIES AND GUIDES.

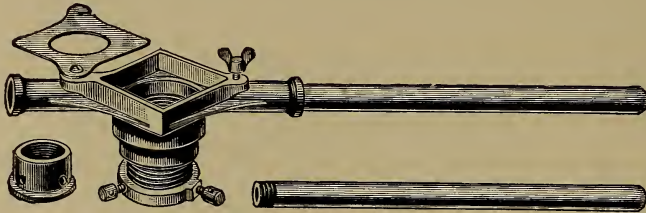

Code	Maulfrom	Maulklem
Numbers	1	2
Dimensions of dies, inches.....	2½x2½x¾	4x4x¾
Pipe sizes of dies, inches.....	¼, ¾, ½, ¾, 1	1¼, 1½, 2
Each, complete	\$15.00	20.00
Weight each, complete, lbs	16	26

Leader Screws used on No. 2 Stocks.
One in a box.

† **HOLLAND’S STOCKS ONLY.**

Code	Maulstack	Maumlet
Numbers	1	2
Each	\$5.00	9.50

Loose.

† **WALWORTH’S PIPE STOCKS AND DIES.**

WITH RIGHT HAND DIES AND GUIDES.

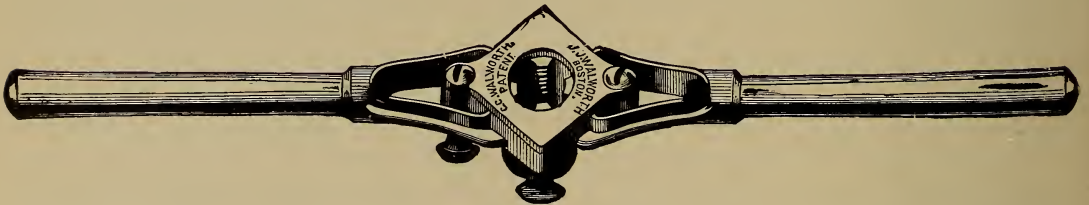

Code.....	Maunder	Mauricoer
Numbers	1	2
Dimensions of dies, inches	2½x2½x¾	4x4x¾
Pipe sizes of dies, inches	¼, ¾, ½, ¾, 1	1¼, 1½, 2
Each, complete	\$15.00	20.00
Weight each, complete, lbs.....	15	28

Leader Screws used on No. 2 Stocks.
One in a box.

† **Extras For Walworth Stocks.**

	Number 1			Number 2	
Code	Part	Each	Code	Part	Each
Mauritan	Plate Screw	\$0.25	Mausoleum	Plate Screw	\$0.25
Mauserite	Cap Plates	.50	Mavortica	Cap Plate	.75
Mauserize	Handles	.75	Mayoret	Leader Screw	1.50

† Carried in San Francisco only.

†**NYE PIPE DIES.**

MADE OF FINEST TOOL STEEL CAREFULLY HARDENED. ABSOLUTELY GUARANTEED.

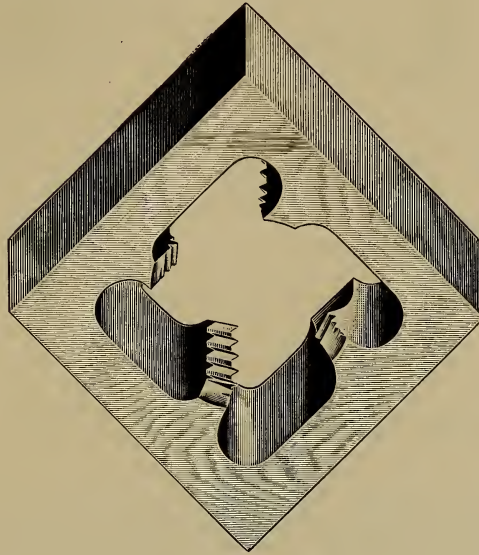

Right Hand Dies for No. 1 Stocks. Size of Block, $2\frac{3}{8} \times 2\frac{3}{8} \times \frac{3}{4}$ inches.

Code	Mazzabaft	Mazzalino	Mazzamur	Mazzanon	Mazzapall	Mazzaquin
Pipe size, inch	$\frac{1}{8}$	$\frac{1}{4}$	$\frac{3}{8}$	$\frac{1}{2}$	$\frac{3}{4}$	1
Each	\$2.00	2.50	2.50	3.00	3.00	4.00

Right Hand Dies for No. 2 Stocks. Size of Block, $4 \times 4 \times \frac{7}{8}$ inches.

Code	Mazzedux	Mazzegog	Mazzeheur	Mazzejus†
Pipe size, inch	1	$1\frac{1}{4}$	$1\frac{1}{2}$	2
Each	\$4.50	4.50	5.00	5.00

In principle the Nye Die is a radical departure from all heretofore accepted types of pipe-threading Dies. The small number of cutting teeth and their peculiar arrangement, is such that the friction generated in cutting a thread is **75 per cent less** than any other die, and consequently the power required to cut a thread is reduced proportionately. The construction is such that behind the first set of teeth there is only one tooth in each full turn of the thread. This allows free play of the oil around each tooth and also prevents the severe binding which is so characteristic of all other Dies. The thread cut with this Die is clear and perfect and equal in every respect to the finest machine made thread. It is impossible to injure either the thread or the Die in backing off.

A boy can easily thread any 2-inch steel pipe with this Die.

†Carried in San Francisco only.

†HOLLAND'S RATCHET PIPE STOCKS.

WITH SHIELDS COVERING RATCHET WHEELS.



Code	Mazapard	Mazzacort
Numbers	1	2
Dimensions of dies, inches	2½x2½x¾	4x4x¾
Pipe sizes of dies, inches	¼, ⅜, ½, ¾, 1	1, 1¼, 1½, 2
Length, inches	20	36
Each	\$9.00	13.00
Weight each, lbs.....	7	21

Price does not include dies.

†HOLLAND'S PIPE DIES.

CUTTERS ARE MADE OF THE HIGHEST GRADE JESSOP STEEL.



Right or Left Hand Dies. For No. 1 Stocks 2½x2½x¾ Inches.

Code, right hand.....	Meacular	Meanders	Meatoribo	Mecadura	Meconopsi	Medelade
Code, left hand	Mediador	Medianist	Mediatize	Medicabel	Medicanto	Medicatrix
Pipe size, inch	¼	¼	¾	½	¾	1
Each	\$2.00	2.00	2.00	2.00	2.00	2.00

Right or Left Hand Dies. For No. 2 Stocks 4x4x¾ Inches.

Code, right hand	Mediolor	Meditamo	Meditator	Medontida	Medrabamo
Code, left hand.....	Medullate	Medusia	Meelkite	Meerballe	Meerdiste
Pipe size, inches	¾	1	1¼	1½	2
Each	\$3.50	3.50	3.50	3.50	3.50

We always ship Right Hand Dies unless Left Hand are ordered.

† Carried in San Francisco only.

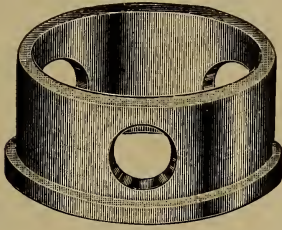

† BUSHINGS OR GUIDES.

For No. 1 Stocks.

Code	Meerhund	Mefitism
Pipe size, inch.....	1/8	1/4
Each.....	\$0.35	.35

Code.....	Megalense	Megalith	Meidenhed	Meiloupe
Pipe size, inch	3/8	1/2	3/4	1
Each	\$0.35	.35	.35	.35

For No. 2 Stocks.

Code	Meissel	Mejicano	Mejoram	Melampit	Melamtheme
Pipe size, inches	3/4	1	1 1/4	1 1/2	2
Each	\$0.60	.60	.60	.60	.60

† PIPE TAPS.

RIGHT AND LEFT HAND.

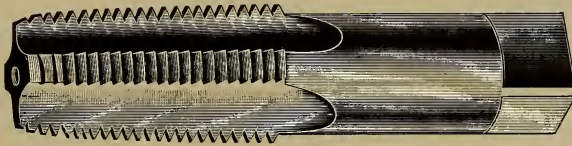

Code, right hand..	Melanchro	Melanfile	Melangion	Melanure	Melardine	Melastome	Melchiade	Me,dekar	Melenudo
Code, left hand...	Meletide	Meliboca	Melifique	Meliorate	Meliphage	Melisford	Melizomi	Melkacht	Melkbade
Size pipe, inches..	1/8	1/4	3/8	1/2	3/4	1	1 1/4	1 1/2	2
Each	\$1.12	1.25	1.50	1.87	2.50	3.12	3.75	4.62	6.25
Weight each, lbs..	1/16	1/8	1/4	3/8	3/4	1 1/4	2	2 1/2	4

Pipe Taps are sent with Right Hand Threads unless Left Hand is specified.

One in a box.

† PIPE REAMERS.



Code	Melkdiste	Melkgeite	Melkschut	Mellicrat	Mellifero	Mellowed	Melocarlo	Melodian
Size pipe, inches	1/4	3/8	1/2	3/4	1	1 1/4	1 1/2	2
Each	\$1.25	1.50	1.87	2.50	3.12	3.75	4.62	6.25

Sizes of twist drills to be used in boring holes to be reamed with pipe reamer and threaded with pipe tap are as follows:—

Pipe tap, inches	1/8	1/4	3/8	1/2	3/4	1	1 1/4	1 1/2	2
Drill diameter, inches	2 1/64	2 9/64	2 9/32	2 3/32	1 5/16	1 3/16	1 15/32	1 23/32	2 3/16

†Carried in San Francisco only.

NEW ECLIPSE TAPPING MACHINE.

FOR TAPPING WATER MAINS OR OTHER PIPES UNDER PRESSURE.

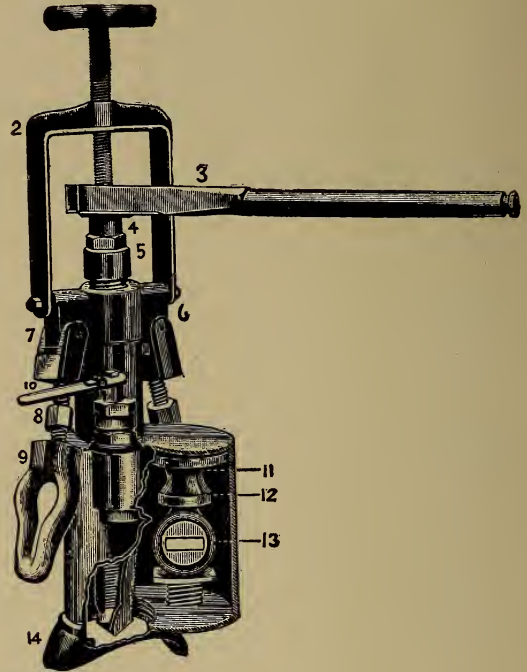
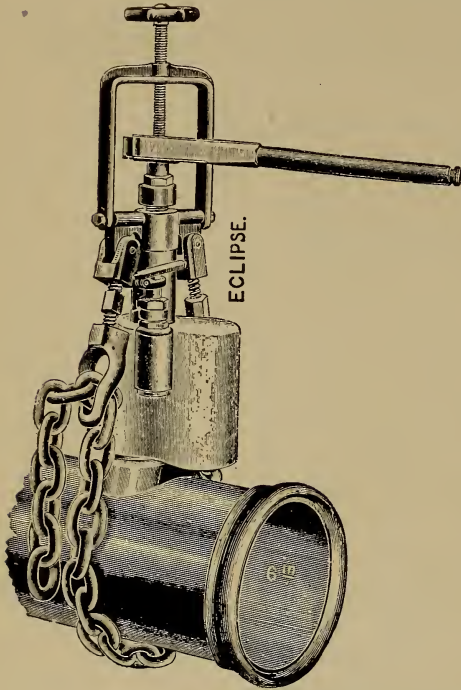

Every Machine tested to 600 pounds to the square inch and guaranteed. These Machines are made of the best bronze metal. The saddles are made of malleable iron and will not break. Taps on the top or side or any angle desired.

Code.....	Meloditte	Melodiano
Numbers	1	2
Taps, inches.....	$\frac{3}{8}$, $\frac{1}{2}$, $\frac{3}{4}$ and 1	1, $1\frac{1}{4}$, $1\frac{1}{2}$ and 2
Each complete.....	\$100.00	150.00
Weight each, lbs.....	25	35

The No. 2 Machine will tap all the small sizes by getting the taps and mandrels extra.

Price List of Extra Tools.

Inches, $\frac{1}{4}$ or $\frac{3}{8}$		$\frac{1}{2}$	$\frac{3}{4}$	1	$1\frac{1}{4}$	$1\frac{1}{2}$	2
Extra Taps, each.....	\$3.00	4.00	4.50	5.00	6.00	7.00	8.00
Mandrels.....	Each \$1.00	Each \$0.25	Spanner Wrenches....	Each \$0.25	Crane	Each \$0.50	
Saddles.....	1.00	Clevises.....	25	Cross "50	Folding Handle..	.50
Chains.....	1.00	Feeder Yoke... 1.00	Rubber Gasket... .10	Cram Post.....	.25	Stuffing-Box Gland....	.50
Tightening Bolts... .25	Feeder Screws 1.00	Cast Iron "08	Extra Heavy No. 3 Ratchet, \$5.00.				

Directions for Operating Payne's Eclipse Tapping Machine.

Screw the corporation cock 13 into the mandrel 12. Then with handle 10 swing the crane 11 over the opening in bottom of machine and screw mandrel 12 into the crane 11. Then swing the crane around into the recess, as shown in above cut, and fold up handle 10. Put the combined tap and drill 4 into the machine. Put saddle 14 into the main and set the machine on the saddle. Pass the ends of the chain through the harps 9 and tighten chain by means of tightening bolts 8. Put the ratchet 3 on the drill 4 and swing the feed yoke 2 to position and tighten up feed screw 1. After having drilled and tapped the hole, draw tap 4 into the machine through stuffing-box 5, open the handle 10 and swing crane around so that mandrel 12 is directly under the tap and drill 4, push down on the tap, screw it into the mandrel and continue until it unscrews mandrel out of crane 11. Then by means of the ratchet 3, screw cock into the main, loosen chains, take off machine and unscrew tap and mandrel from cock.

In Orders and Specifications give Plate Numbers.

“CENTURY” SERVICE CLAMP TAPPING MACHINE.

(Patented.)

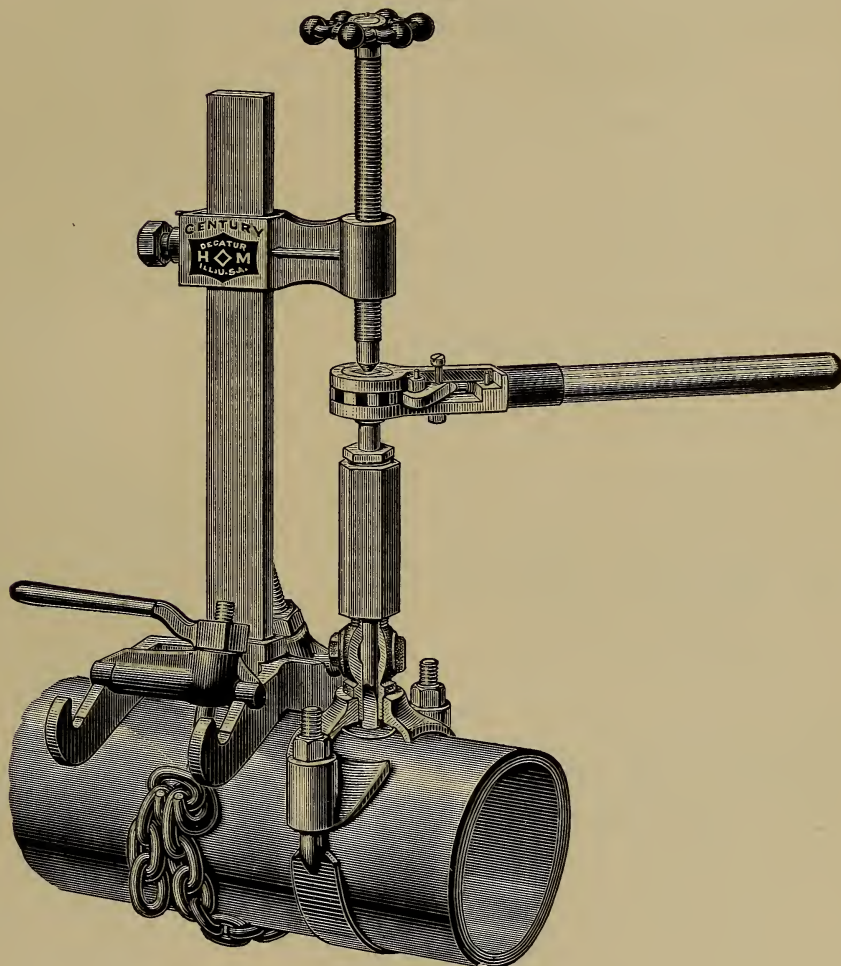

These machines are designed for use wherever the thickness of the pipe to be tapped will not safely hold up a stop cock or service pipe without the support of a service clamp or saddle. With this machine taps can be made without loss for hot or cold water, gas or oil service. The machine will drill pipes for $\frac{1}{2}$, $\frac{3}{8}$, $\frac{3}{4}$ and 1-inch stop cocks upon any size pipe. When used without the stuffing-box, tools up to 18 inches in length can be used, and it will tap up to 3-inch.

Code.....	Melodoor
Machine, complete with Ratchet, $\frac{1}{2}$, $\frac{3}{8}$, $\frac{3}{4}$ and 1-inch Drills and Stuffing-Boxes.....	\$40.00
Shipping weight, lbs.....	90

Packed in a special wood compartment case.

Unless otherwise specified, Iron Pipe Thread on the lower end of Stuffing-Boxes, and Chain for 12-inch Pipe, will be furnished upon all orders. Other threads can be furnished upon specification.

In Orders and Specifications give Plate Numbers.

† **H. M. & S. TELEGRAPH
FIREPOTS.**

REFINED SMOOTH STEEL.

Code.....	Geliador
Top diameter, inches.....	6¼
Height, inches.....	12½
Each	\$5.60
Weight each, lbs.....	4½

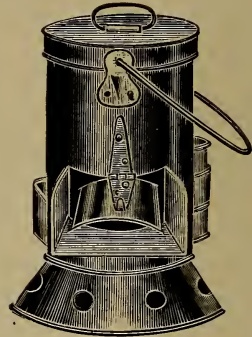

† **H. M. & S. TINNERS'
FIRE POTS.**

REFINED SMOOTH STEEL.

Code.....	Gelibatur
Diameter, inches.....	7¼
Height, inches.....	15
Each	\$4.50
Weight each, lbs.....	7½



† **H. M. & S. PLUMBERS'
FIRE POTS.**

REFINED SMOOTH STEEL. HEAVY.

Code.....	Geliacose
Top diameter, inches.....	11
Height, inches.....	14
Each	\$5.00
Weight each, lbs.....	7½

† Carried in San Francisco only.



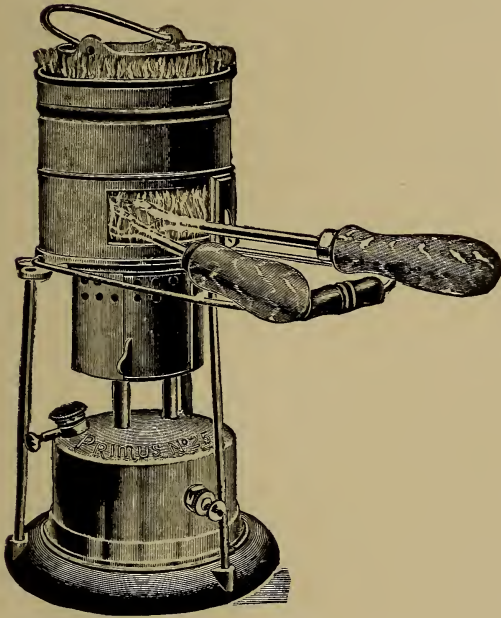

† PRIMUS PLUMBERS' COMBINATION FURNACES.

TWO BURNERS. CAST IRON BASE. SHEET STEEL HOOD.

Can be used in open air, having a wind Guard which perfectly protects the flame. Will melt and heat irons at the same time. Hood is detachable. The Lamp may be removed from the frame for separate use. With 6-inch Pot.

One and one-half quarts of oil will operate both burners for three hours.

Code.....	Gondager
Number.....	25
Capacity, quarts.....	1½
Height, inches.....	19½
Base, inches.....	9
Each.....	\$6.50
Weight per crate, lbs.....	20
Shipping measurement per crate, cubic feet.....	1½

One in a crate.

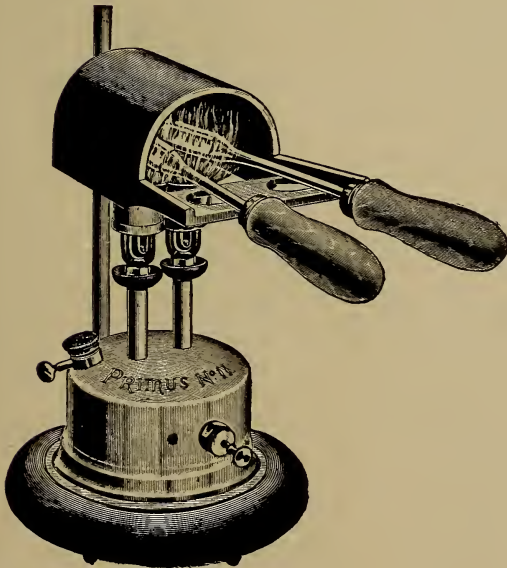

† PRIMUS SOLDERING FURNACES.

TWO BURNERS. CAST IRON HOOD. CAST IRON BASE FOR INDOOR USE.

Double Hood is open clear through, thereby permitting the introduction of a 2-inch pipe of any length. The Single Hood Furnace has small opening at top with a cover, to permit use of metal Pot.

Code.....	Gondirast	Gondkiste
Numbers.....	11	11
Style of hood.....	Single	Double
Capacity, quarts.....	1½	1½
Height, inches.....	16	16
Base, inches.....	9	9
Each.....	\$10.00	10.50
Weight per crate, lbs.....	20	22
Shipping measurement per rate, cu. ft.....	1½	1½

One in a crate.

† Carried in San Francisco only.

GASOLINE FIRE POTS AND TORCHES.

† CLAYTON & LAMBERT FIRE POTS.

BRONZE METAL BURNERS WITH CLEAN-OUT PLUGS.
PERFECT AND DURABLE PUMPS.
REMOVABLE HOODS.

Code	Goorgate
Number	1
Capacity of oil tank, quarts.....	2
Diameter of oil tank, inches.....	8 $\frac{3}{4}$
Height over all, inches.....	11 $\frac{1}{2}$
Each.....	\$6.00
Shipping weight, lbs.....	12 $\frac{1}{2}$
Shipping measure, cubic foot.....	$\frac{5}{6}$

One in a case.



† CLAYTON & LAMBERT FIRE POTS.

SAME AS No. 1 EXCEPT THAT IT IS SMALLER.

Code	Goorlepe
Number	5
Capacity of oil tank, quarts.....	1 $\frac{1}{2}$
Diameter of oil tank, inches.....	7 $\frac{3}{4}$
Height over all, inches.....	11 $\frac{1}{2}$
Each.....	\$4.50
Shipping weight, lbs.....	12
Shipping measure, cubic foot.....	$\frac{2}{3}$

One in a case.

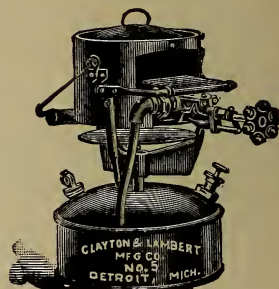

† CLAYTON & LAMBERT FIRE POTS.

SAME AS No. 1 EXCEPT THAT IT IS SMALL ENOUGH
TO BE PACKED IN A TOOL BAG.

Code	Goornous
Number	6
Capacity of oil tank, quart.....	1
Diameter of oil tank, inches.....	6 $\frac{1}{4}$
Height over all, inches.....	9 $\frac{1}{4}$
Each.....	\$4.00
Shipping weight, lbs.....	9
Shipping measure, cubic foot.....	$\frac{5}{12}$

One in a case.

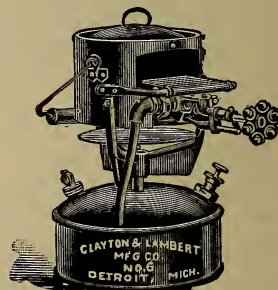

† CLAYTON & LAMBERT FIRE POTS.

SAME AS No. 1 EXCEPT THAT IT HAS TWO BURNERS.

Code	Goorprim
Number	15
Capacity of oil tank, quarts.....	2
Diameter of oil tank, inches.....	8 $\frac{3}{4}$
Height over all, inches	11 $\frac{1}{2}$
Each.....	\$8.00
Shipping weight, lbs.....	15
Shipping measure, cubic foot.....	$\frac{5}{6}$

One in a case

† Carried in San Francisco only.

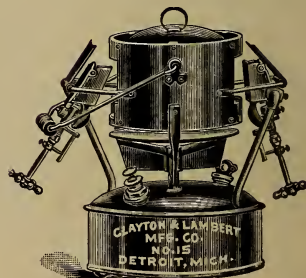

CLAYTON & LAMBERT FIRE POTS.

STRONG AND DURABLE. EXTRA HEAVY PIPE COILS.
NEEDLE AIR VALVES. BRASS AIR PUMPS.
IMPROVED FEED VALVES.

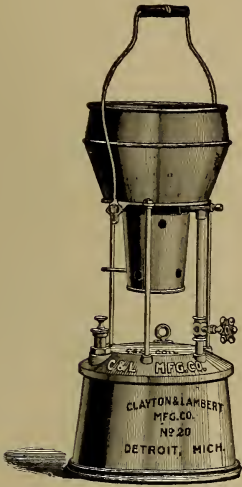

Code.....	Goorsmit
Number	20
Capacity of oil tank, quarts.....	2
Diameter of oil tank, inches.....	8½
Height over all, inches.....	18
Each.....	\$3.25
Shipping weight, lbs.....	13
Shipping measurement, cubic foot.....	⅓

One in a case.

† CLAYTON & LAMBERT TORCHES.

POLISHED BRASS. MADE OF No. 18 BRASS. BRASS
AIR PUMPS, SERVE AS HANDLES. MAKES
A FINE NEEDLE FLAME.



Code.....	Goorwasp
Number	3
Capacity, quart.....	½
Diameter, inches.....	3¾
Height, inches.....	5¾
Each.....	\$2.00
Shipping weight, lbs.....	1¾
Shipping measurement, cubic foot.....	⅙

One in a case.

CLAYTON & LAMBERT TORCHES.

POLISHED BRASS. SEAMLESS. ROUND BURNERS WITH
LARGE CLEAN-OUT OPENINGS. BRASS AIR
PUMPS. WILL NOT BLOW OUT.



Code.....	Goorstole
Number	31
Capacity, quart.....	1
Diameter, inches.....	5¾
Height, inches.....	9
Each.....	\$2.50
Shipping weight, lbs.....	5
Shipping measurement, cubic foot.....	⅓

One in a case.

† Carried in San Francisco only.

CLAYTON & LAMBERT TORCHES.

POLISHED BRASS. WITH SMALL AND LARGE BURNER.

Code.....	Gootsank
Number.....	5
Capacity, quart.....	1
Diameter, inches.....	5½
Height, inches.....	10
Each.....	\$3.00
Shipping weight, lbs.....	5
Shipping measure, cubic foot.....	⅓

One in a case.

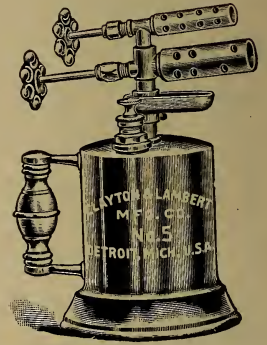

CLAYTON & LAMBERT TORCHES.

POLISHED BRASS. SEAMLESS. IMPROVED BURNERS AND SWIVELS. BRASS AIR PUMPS. WILL NOT BLOW OUT.

Code.....	Goorspane
Number.....	1
Capacity, quart.....	1
Diameter, inches.....	5¾
Height, inches.....	9
Each.....	\$3.00
Shipping weight, lbs.....	5½
Shipping measurement, cubic foot.....	⅓

One in a case.



CLAYTON & LAMBERT TORCHES.

POLISHED BRASS. SEAMLESS. BRASS AIR PUMPS IN HANDLES. ROUND BURNERS, WITH WOOD HANDLES. POWERFUL, STRONG AND ECONOMICAL.

Code.....	Gootsklam
Number.....	16
Capacity, quart.....	1
Diameter, inches.....	5¾
Height, inches.....	9
Each.....	\$2.25
Shipping weight, lbs.....	5
Shipping measure, cubic foot.....	⅓

One in a case.



CLAYTON & LAMBERT TORCHES.

POLISHED BRASS. SEAMLESS. BRASS AIR PUMPS IN HANDLES. HOOK ON BURNER FOR HOLDING SOLDERING IRONS.

Code.....	Gootslept
Number.....	17
Capacity, quart.....	1
Diameter, inches.....	5¾
Height, inches.....	10
Each.....	\$2.50
Shipping weight, lbs.....	5¼
Shipping measure, cubic feet.....	⅓

One in a case.

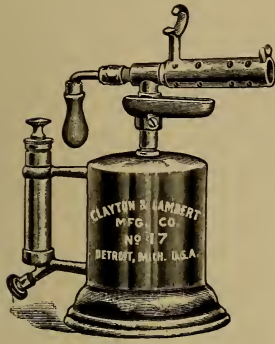

CLAYTON & LAMBERT TORCHES.

POLISHED BRASS. SAME AS No. 16, EXCEPT THAT IT IS SMALLER.

Code.....	Gootstow
Number.....	18
Capacity, quart.....	½
Diameter, inches.....	4⅝
Height, inches.....	8
Each.....	\$2.00
Shipping weight, lbs.....	3½
Shipping measure, cubic foot.....	⅓

One in a case.



† CLAYTON & LAMBERT TORCHES.

NICKEL-PLATED BRASS. FOR ALCOHOL OR GASOLINE. ADJUSTABLE BLOW PIPES. SCREW CAP.

Code.....	Gootsvolk
Number.....	11
Diameter, inch.....	7/8
Length, inches.....	6
Each.....	\$0.75
Weight each, lb.....	¼

One in a box.



† CLAYTON & LAMBERT TORCHES.

POLISHED BRASS. FOR ALCOHOL OR GASOLINE. AIR BLAST PASSES THROUGH A CHAMBER CHARGED WITH GAS WHICH MAKES A MUCH STRONGER FIRE THAN CAN BE HAD IN ANY OTHER WAY. SCREW CAPS.

Code.....	Gorably
Number.....	14
Diameter, inches.....	1¾
Length, inches.....	6½
Each.....	\$1.00
Weight each, lb.....	1

One in a box.

† Carried in San Francisco only.



† **VULCAN TORCHES.**

POLISHED BRASS. WOOD HANDLES SCREW ON IN TWO POSITIONS. FOR GASOLINE. NO WICKS.

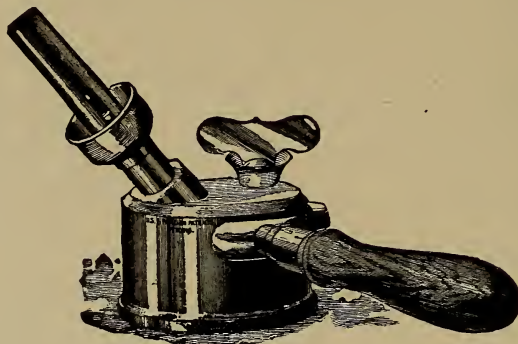

Code	Goraneck
Diameter, inches.....	3$\frac{3}{8}$
Height of oil tank, inches.....	2
Each.....	\$4.00

† Carried in San Francisco only.

REPAIRS FOR FIRE POTS.



FILLER PLUG.
15c—mail 18c

BURNER & SWIVEL
\$2.00 net, if by mail \$2.20

PUMP FOR FIRE POT OR TORCH.
40c, if by mail 50c

PUMP COLLAR.
10c

AIR VALVE.
25c, by mail 30c





















FILLER.
25c, by mail 30c

SWIVEL.
50c, by mail 55c

Numbers of Fire Pots	1	5	6	15
Base complete with Burner	\$4.00	3.00	3.00	6.00
Code	Gorbolete	Gorbonica	Gorboritas	Gorbotamo
Top Section	\$2.00	1.50	1.00	2.00
Code	Gorbotase	Gordaler	Gordank	Gordhake
Burner only.....	\$1.50	1.50	1.50	1.50
Code.....	Gordman	Gordpaper	Gordrage	Gordzang
Swivel	\$0.50	.50	.50	.50
Code	Gorealis	Goreasm	Goreotid	Gorghise
Filler Plug.....	\$0.15	.15	.15	.15
Code	Gorghette	Gorgodil	Gorgolane	Gorgonate
Filler Collar.....	\$0.10	.10	.10	.10
Code	Gorgonzolo	Gorlabor	Gormonie	Gornoyer
Pump	\$0.40	.40	.40	.40
Code	Gornpute	Gorracat	Gorrachic	Gorratell
Pump Collar.....	\$0.10	.10	.10	.10
Code.....	Gorregul	Gorricane	Gorrimust	Gorsdorf
Drip Cup or Hood.....	\$0.25	.25	.25	.25
Code	Gorsippe	Gorstade	Gorstkler	Gorstkoop
Needle and Stuffing-box	\$0.25	.25	.25	.25
Code.....	Gorstlapp	Gorstmete	Gorstpin	Gorstrem

When repair parts are sent by mail postage will be charged.

COIL FIRE POT REPAIRS.

<i>Burner</i>  EACH .10¢	<i>Connecting Pipe</i>  EACH .08¢	<i>Coil</i>  EACH .25¢	<i>Coil Cup</i>  EACH .25¢	<i>Ell</i>  EACH .04¢
<i>Filler Plug</i>  EACH .10¢	<i>Handle Ear</i>  EACH .04¢	<i>Handle</i>  EACH .15¢	<i>Nuts</i>  No 1 No 2 EACH .01¢	<i>Valve</i>  EACH .30¢
<i>Air Valve</i>  EACH .25¢	<i>Plug</i>  EACH .04¢	<i>Reservoir</i>  EACH 1.50	<i>Bulb</i>  EACH .20¢	<i>Shield</i>  No. 1 & No. 2 EACH .35¢
<i>No. 3 Shield</i>  EACH .75¢	<i>Tee</i>  EACH .04¢	<i>Top Plate</i>  EACH .15¢	<i>Upright</i>  EACH .06¢	<i>Wire for Coil</i>  EACH .05¢

Name of Part.	Price.	Code.	Name of Part.	Price.	Code.
Burner.....	\$0.10	Gorstroke	Plug.....	\$0.04	Gosporic
Connecting Pipe.....	.08	Gorstwier	No. 20 Reservoir	1.50	Gossage
Coil.....	.25	Gorzegum	Bulb20	Gossoner
Coil Cup.....	.25	Gorzolette	No. 1 Shield.....	.35	Gostange
Ell.....	.04	Gosarde	No. 2 Shield.....	.35	Gostello
Filler Plug10	Goschdruf	No. 3 Shield.....	.75	Gostezam
Handle Ear04	Goschgood	Tee.....	.04	Gostezase
Handle.....	.15	Goschloot	Top Plate15	Gostriche
No. 1 Nut.....	.01	Goschslag	Upright06	Goswell
No. 2 Nut.....	.01	Goschwind	Wire for Coil05	Gotanike
Valve.....	.30	Gosorim	Pump.....	.40	Gotavan
Air Valve.....	.25	Gospeler			

When repair parts are sent by mail postage will be charged.

TORCH REPAIRS.

Numbers of Torches	1	2	3	5	6	16	18
Burner	\$1.50	1.25	1.25	1.75	1.40	1.25	1.25
Code	Gotelheir	Gotellone	Gotenlaf	Goterblom	Goterdeg	Goterend	Gotergerba
Filler Plug	\$0.15	.15	.15	.15	.15	.15	.15
Code	Goterhust	Gotermark	Goterpote	Goterwag	Goterzar	Gothic	Gothrope
Filler Collar.....	\$0.10	.10	.10	.10	.10	.10	.10
Code	Gotorale	Gotrobat	Gotryone	Gotsend	Gottegon	Gottelem	Gottelore
Burner Tube	\$......	.20	.20	.20	.20	.20	.20
Code	Gotthame	Gotschur	Gouboul	Gouchard	Gouchasse	Gouchero	Goudante
Pump.....	\$0.40	.40	.40	.40	.40	.40	.40
Code	Gondelore	Goudinet	Gouffare	Gouganest	Goulange	Goulever	Gouloure
Pump Collar	\$0.10	.10	.10	.10	.10
Code	Gourbond	Gourbote	Gourdalo	Gourmand	Gourrell	Goursicat	Gousiner
Tanks only.....	\$1.00	1.00	.75	1.00	1.00	1.00	1.00
Code.....	Goussart	Goutadex	Goutbore	Goutkoge	Gouttan	Gouvete	Gouzemon

When repair parts are sent by mail postage will be charged.

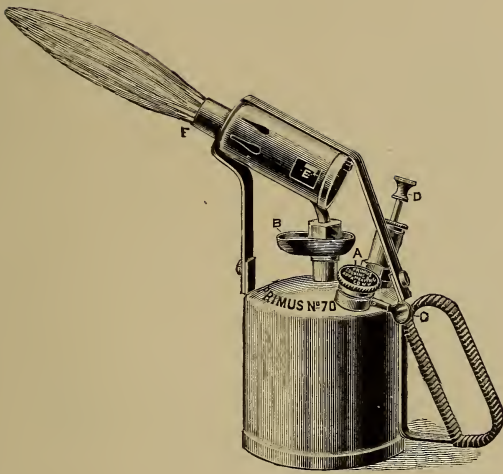

† **PRIMUS BRAZIER'S TORCHES.**

POLISHED BRASS. FOR BURNING COAL OIL.

The most powerful Torches made, producing an intense steady heat of 2600 degrees F. Capable of melting copper wire $\frac{5}{16}$ of an inch thick in the open flame. Consumes $\frac{1}{2}$ quart of oil per hour. Will burn in any position.

Code	Gombastic	Gombica
Numbers	70	71
Capacity, pints	1	2
Diameter, inches	3 $\frac{3}{4}$	4 $\frac{3}{4}$
Height, inches	9 $\frac{3}{8}$	9 $\frac{7}{8}$
Extreme bottom, inches.....	8 $\frac{3}{4}$	9
Each	\$4.50	5.50
Weight per case, lbs.....	27	30
Shipping measurement per case, cu. ft.....	1 $\frac{1}{4}$	1 $\frac{3}{4}$

Six in a case.

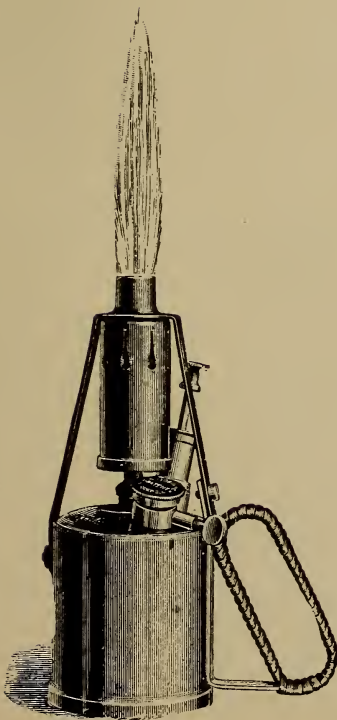

† **PRIMUS BRAZIER'S TORCHES.**

POLISHED BRASS. FOR BURNING COAL OIL.

The most powerful Torches made, producing an intense steady heat of 2600 degrees F. Capable of melting copper wire $\frac{5}{16}$ of an inch thick in the open flame. Consumes $\frac{1}{2}$ quart of oil per hour. Will burn in any position.

Code.....	Gombidot	Gombihul
Numbers	72	73
Capacity, pints.....	1	2
Diameter, inches.....	3 $\frac{3}{4}$	4 $\frac{3}{4}$
Height, inches.....	11 $\frac{1}{2}$	11 $\frac{3}{4}$
Extreme width, inches.....	7	8
Each	\$4.50	5.50
Weight per case, lbs.....	27	30
Shipping measurement per case, cu. ft.	1 $\frac{1}{4}$	1 $\frac{3}{4}$

Six in a case.

† Carried in San Francisco only.



† **PRIMUS PAINTERS' TORCHES.**

POLISHED BRASS. FOR BURNING COAL OIL.

Will stand wind. Will produce heat of 2100 degrees F. Will consume $\frac{1}{3}$ quart of oil per hour. Will burn in any position.

Code.....	Gombilate	Gombilon
Numbers	40	41
Capacity, pints.....	1	2
Diameter, inches.....	3 $\frac{5}{8}$	4 $\frac{5}{8}$
Height, inches.....	8 $\frac{7}{8}$	9 $\frac{1}{8}$
Extreme bottom, inches.....	8 $\frac{3}{8}$	9
Each.....	\$4.50	5.50
Weight per case, lbs.....	27	30
Shipping measurement per case, cubic ft.....	1 $\frac{1}{4}$	1 $\frac{3}{4}$

Six in a case.

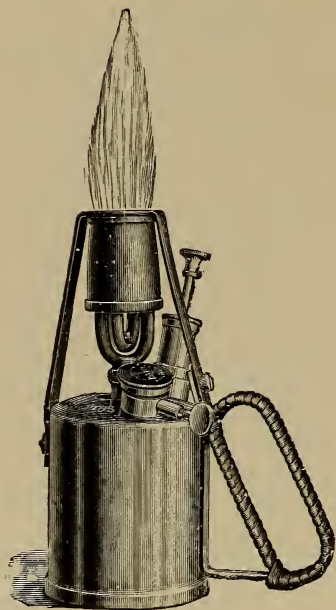

† **PRIMUS PAINTERS' TORCHES.**

POLISHED BRASS. FOR BURNING COAL OIL.

Will stand wind. Will produce heat of 2100 degrees F. Will consume $\frac{1}{3}$ quart of oil per hour. Will burn in any position.

Code.....	Gombutt	Gombuzell
Numbers	42	43
Capacity, pints.....	1	2
Diameter, inches	3 $\frac{5}{8}$	4 $\frac{5}{8}$
Height, inches	9 $\frac{3}{4}$	10 $\frac{1}{2}$
Extreme width at bottom, inches.....	8 $\frac{3}{8}$	9
Each	\$4.50	5.50
Weight per case, lbs.....	27	30
Shipping measurement per case, cubic ft.....	1 $\frac{1}{4}$	1 $\frac{3}{4}$

Six in a case.

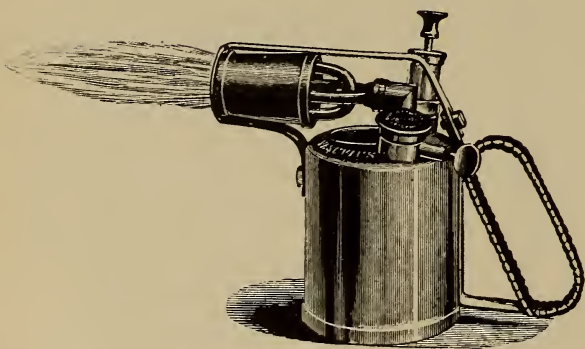

† **PRIMUS PAINTERS' TORCHES.**

POLISHED BRASS. FOR BURNING COAL OIL.

Will stand wind. Will produce heat of 2100 degrees F. Will consume $\frac{1}{3}$ quart of oil per hour. Will burn in any position.

Code.....	Gomdate	Gomdull
Numbers	44	45
Capacity, pints.....	1	2
Diameter, inches.....	3 $\frac{5}{8}$	4 $\frac{5}{8}$
Height, inches.....	7 $\frac{1}{2}$	8
Extreme width, inches.....	9	9 $\frac{1}{2}$
Each	\$4.50	5.50
Weight per case, lbs	30	33
Shipping measurement per case, cubic ft.....	1 $\frac{1}{4}$	1 $\frac{3}{4}$

Six in a case.

† Carried in San Francisco only.

† **PRIMUS GIANT HEATERS.**

WITH No. 252 BURNERS.

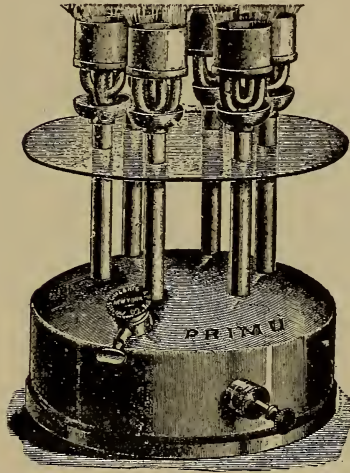

CUT SHOWS No. 33.

For any use requiring intense heat production in a limited space, this apparatus is particularly available. It is now being successfully used for a large variety of purposes, among which may be mentioned: The operation of oil and hot-air engines; heating branding irons; melting lead; heating steam tables; boiling large quantities of liquids; heating hot water urns; in the dental profession for melting gold, vulcanizing rubber, and heating or boiling wax; in the medical profession for operating "Formaldehyde" gas generators; in hospitals for sterilizing and other purposes; and by some of the leading New York newspapers for "Lino-type" machines.

It is powerful, compact, odorless and safe.

The Giant Heater is made regularly in 1, 2, 3, 4, 6 and 8 burners, and will be made of larger size with any desired number of burners upon special order.

It can be fitted as desired with "Original Primus," or "Noiseless" burners, either of which gives a broad, flaring flame—or with "Industrial" burner, which gives a long, upright flame.

Code.....	Gomgate	Gomilcare	Gompress	Gonament	Gondade
Numbers.....	7	31	32	33	34
Number of burners.....	2	3	4	6	8
Capacity, quarts.....	1½	3	4	5	5
Height, inches.....	9¾	12¾	12¼	12¾	12¾
Height of reservoir, inches.....	3⅞	5⅞	5⅞	5½	5½
Diameter of base, inches.....	6⅞	7⅞	8½	9⅞	9⅞
Diameter of burner group, inches.....	3⅞	5⅞	6⅞	6⅞	6⅞
Each.....	\$5.50	10.50	12.00	15.00	18.00
Weight per case, lbs.....	8	11½	13	15	15½
Shipping measurement per case, cubic feet.....	⅝½	⅔	⅝	1	1

One in a case.

† Carried in San Francisco only.

† **DIAMOND VISES.**

JAWS $4 \times \frac{7}{8}$ INCHES, STEEL FACED. ANVIL FACE 3×7 INCHES. STEEL SCREW $\frac{3}{4} \times 10 \frac{1}{2}$ INCHES.

HOLDS PIPES FROM $\frac{1}{2}$ TO 2 INCHES. BODY PAINTED GREEN.

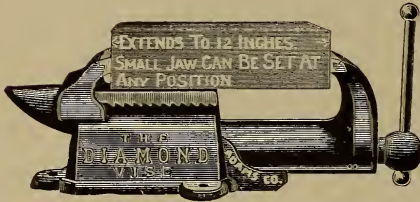

Code	Melodrama
Each.....	\$3.50
Weight packed, lbs.....	42

One in a case.

† **DIAMOND VISES WITH DRILLING ATTACHMENT.**

WILL TAKE SQUARE SHANK DRILLS UP TO $\frac{3}{4}$ INCH.

Code	Membrane
Each.....	\$6.00
Weight complete, lbs.....	57

Drill Attachments are packed separate.

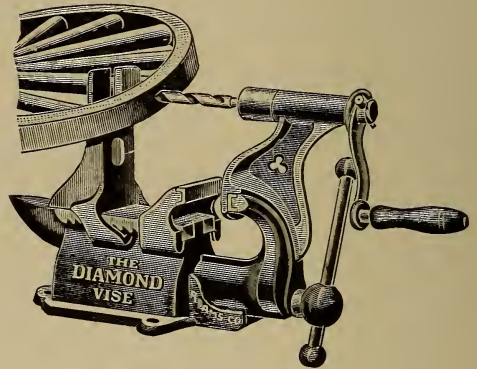

NEW "VULCAN" CHAIN PIPE VISES.

WROUGHT STEEL. DROP-FORGED, SAW-TEMPERED JAWS. PARTS INTERCHANGEABLE. UNBREAKABLE. COMPACT. GRIP IS POSITIVE, NON-CRUSHING AND ALWAYS RENEWABLE BY SIMPLY FILING THE TEETH.

Code.....	Membraput
Number.....	2
Holds pipe, inches.....	$\frac{1}{8}$ to $2 \frac{1}{2}$
Size, folded, inches.....	6 x 8 x 8
Each.....	\$5.00
Weight each, lbs.....	10

† Carried in San Francisco only.

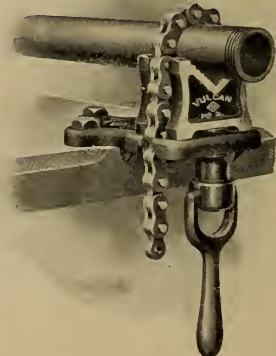

† **TINNERS' PARALLEL VISES.**

POLISHED STEEL JAWS.

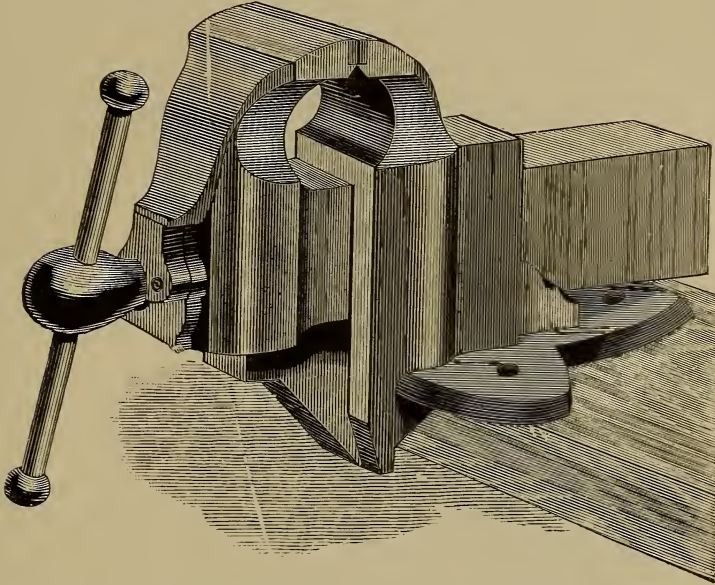

The above Vise is of superior quality. The Jaws are faced with hardened Steel. Adapted to general use.

Code	Membrato
Number.....	200
Width of jaws, inches.....	4¼
Jaws open, inches.....	5½
Each.....	\$10.00
Weight each, lbs.....	42½

Loose.

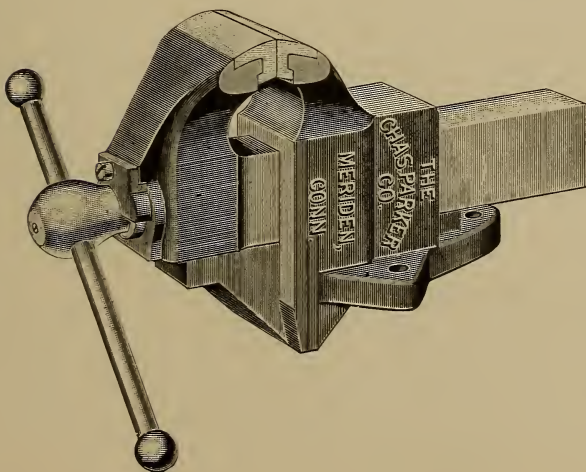

† **PARKER'S PARALLEL VISES.**

The steel faces of these Vises are milled and fitted to the Jaws, and are renewable at a trifling cost.

Code.....	Membrell
Number.....	1X
Width of jaws, inches.....	3¾
Jaws open, inches.....	5½
Each.....	\$7.00
Weight each, lbs.....	45

† Carried in San Francisco only.

†PARKER'S COMBINATION VISES.

SWIVEL BOTTOMS. FOR MACHINE SHOPS, ETC.

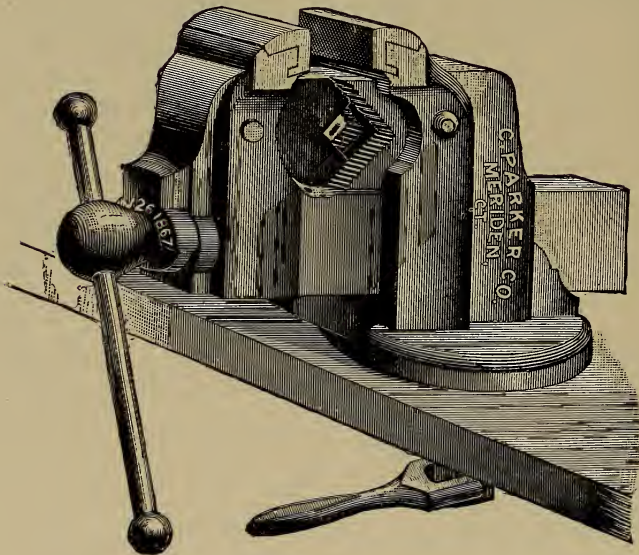

The Steel Faces of these Vises are milled and fitted to the Jaws, and are renewable at a trifling cost.

Code	Membrille	Membrusto
Numbers	87	88
Width of jaws, inches	3 3/8	4 1/8
Jaws open, inches	5	5 1/2
Hold pipe, inches	1/8 to 2	1/4 to 3
Each	\$16.00	20.00
Weight each, lbs.....	41	59

Loose.

† Extra Pipe Jaws for Parker Vises.

Code.....	Menecradle	Mendumin.
Numbers.....	87	88
Per pair	\$3.00	3.00

† Carried in San Francisco only.

† **PARKER'S COMBINATION VISES.**

SWIVEL BOTTOMS. GRAY IRON. FOR TINNERS, PLUMBERS, ETC.

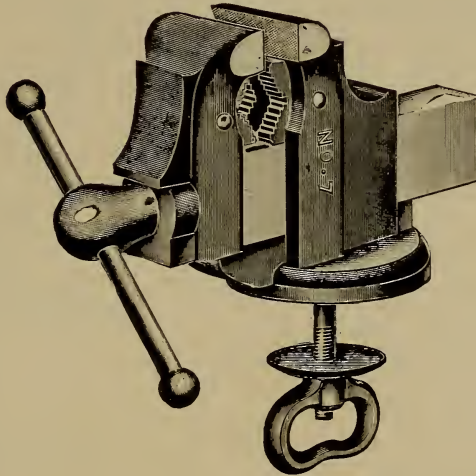

Code.....	Memoire	Memoiris
Numbers.....	7	8
Width of jaws, inches.....	3 3/8	4 1/8
Jaws open, inches.....	5	5 1/2
Hold pipe, inches.....	1/8 to 2	1/4 to 3
Each.....	\$16.00	20.00
Weight each, lbs.....	41	59

Loose.

† **Extra Pipe Jaws for Parker Vises.**

Code.....	Menapico	Menchere
Numbers.....	7	8
Per pair.....	\$3.00	3.00

† **ANGLE PLATE VISES.**

Code.....	Mendacita	Menderest	Mendette
Numbers.....	1	2	3
Hold pipe, inches..	1/8 to 2	1/4 to 3	1/2 to 4
Each.....	\$8.00	15.00	22.00
Weight each, lbs...	32	52

Loose.

† **Extra Jaws.**

Code.....	Mendicamo	Mendicuo
Numbers.....	1	2
Per set.....	\$2.50	3.50

† Carried in San Francisco only.

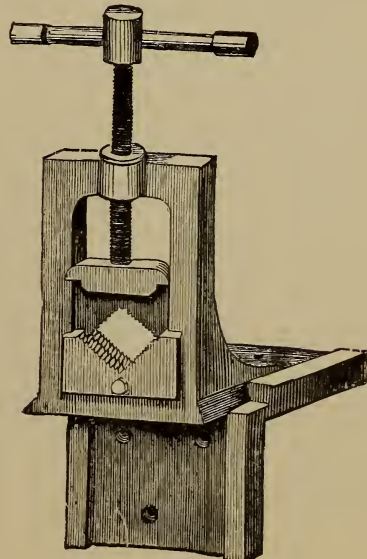

† MALLEABLE IRON PIPE VISES.

FOR POCKET OR TOOL CHEST.

Code	Mendigaro	Mendizaba
Numbers.....	1	2
Range, inches.....	1/8 to 3/4	1/8 to 2
Each	\$3.00	6.00
Weight each, lbs.....	2 1/2	12

Loose.

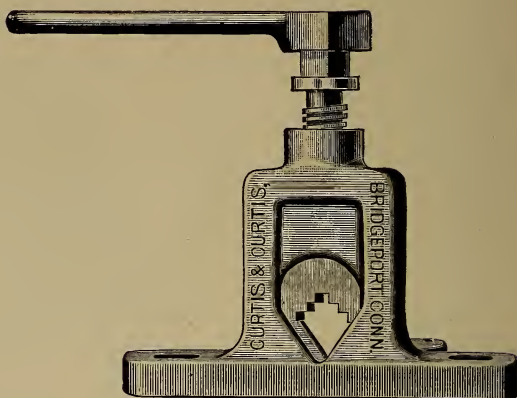

† KEYSTONE PIPE VISES.

MALLEABLE IRON. WITH ROLLER JAWS.

Code	Meneclito	Menelaud
Numbers.....	R	RR
Range, inches	1/8 to 2	1/4 to 3
Each	\$4.00	8.00
Weight each, lbs.....	10	18

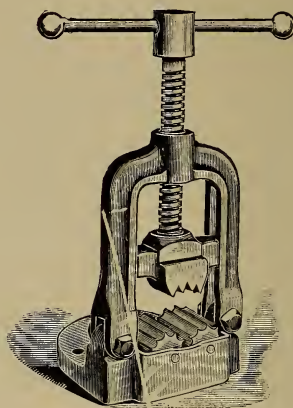

† HINGED COMBINATION PIPE VISES.

MALLEABLE IRON. WITH BENDING FORMS.

Strong and practical. Will give satisfaction for holding or bending pipe. The two bending forms in this Vise will be found a very useful feature, and do not interfere with the jaws or strength of the Vise. The form on the left of the Vise has a flat surface on top which makes a handy place to hammer on. Jaws are of best tool steel and can be sharpened or duplicated.

Code.....	Mengretia	Menguado	Menigrepo
Numbers	1	2	3
Range, inches.....	1/8 to 1 1/4	1/8 to 2	1/8 to 2 1/2
Each	\$8.00	9.00	10.00
Weight each, lbs.....	6	10	18

Loose.

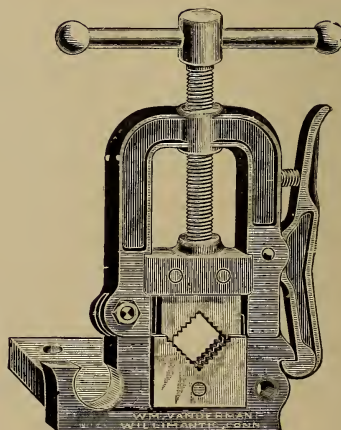

† Carried in San Francisco only.

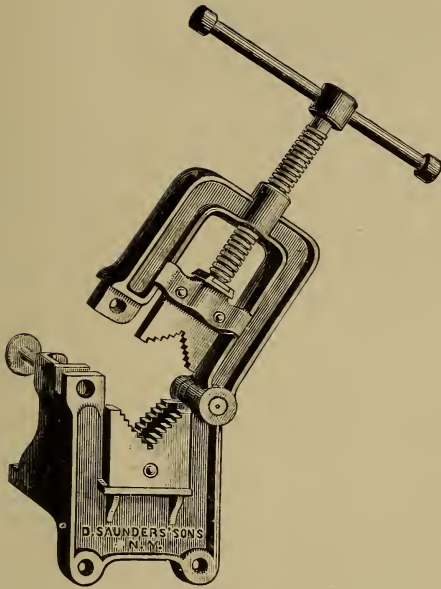

† **SAUNDERS' HINGED PIPE VISES.**

MALLEABLE IRON. STEEL JAWS.

Code.....	Meniscost
Number.....	1
Range, inches.....	1/8 to 2
Each.....	\$10.00
Weight each, lbs.....	18

Loose.

Extra Jaws.

Code.....	Mennonism
Per set.....	\$3.50

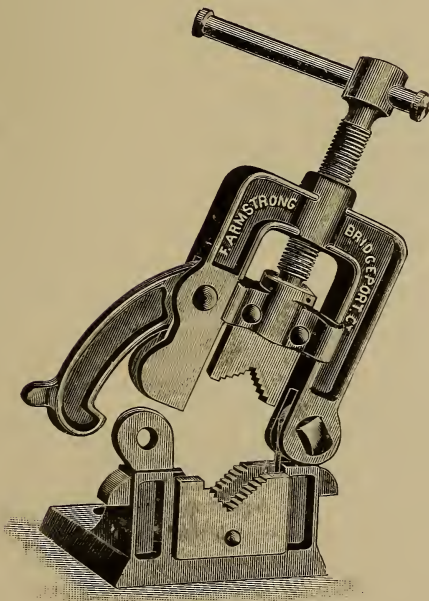

ARMSTRONG'S HINGED PIPE VISES.

MALLEABLE IRON. STEEL JAWS.

Code.....	Menogenic	Menomass
Numbers.....	1	2
Range, inches.....	1/8 to 2 1/2	1/2 to 4 1/2
Each.....	\$10.00	20.00
Weight each, lbs.....	10	40

Loose.

No. 1 is a light pattern.

Extra Upper Jaws.

Code.....	Mensagero	Mensolette
Numbers.....	1	2
Each.....	\$0.50	.75

Extra Lower Jaws.

Code.....	Mensuraba	Mensuride
Numbers.....	1	2
Per pair.....	\$1.00	1.50

† Carried in San Francisco only.

† **PLAIN PIPE TONGS.**



Code	Mentagrim	Mentecapo	Menticard	Mentorium	Mentovate
Size pipe, inch	¼	⅜	½	¾	1
Each.....	\$0.65	.70	.75	.90	1.10
Code	Mentulato	Menudeam	Menulphor	Mephitibo	Merathane
Size pipe, inches	1¼	1½	2	2½	3
Each.....	\$1.30	1.50	1.90	2.50	3.50

Loose.

† **BROWN'S ADJUSTABLE PIPE TONGS.**

FORGED STEEL.

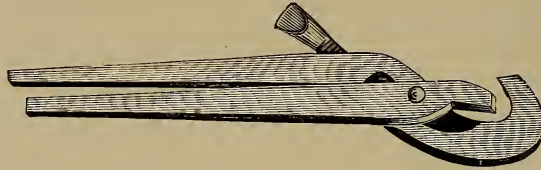

Code	Mercador	Mercando	Mercapit	Mercatoris	Mercedes
Numbers.....	1	1½	2	3	4
Takes pipe, inches.....	⅛ to ¾	⅜ to 1	½ to 1¼	1 to 2	1½ to 3
Each.....	\$1.30	1.65	2.00	3.00	6.00
Weight each, lbs	3¾	4½	7¼	10½	21

Loose.

† **VULCAN CHAIN TONGS.**

WITH FLAT LINK CHAINS. WROUGHT STEEL. DROP FORGED JAWS, SAW TEMPERED. WILL NOT CRUSH PIPE.



Code	Mercemere	Mercenary	Merciful	Mercurial
Numbers.....	11	12	13	14
Takes pipe, inches.....	⅛ to 1½	¼ to 2½	¾ to 4	1½ to 8
Length over all, inches	20	27	37	50½
Length of chains, inches	13½	17½	22½	39
Each.....	\$3.50	5.00	7.00	11.00
Weight each, lbs	4¾	8¾	16	29

Loose.

† Carried in San Francisco only.

TRIMO PIPE WRENCHES.

FORGED STEEL. PARTS INTERCHANGEABLE.

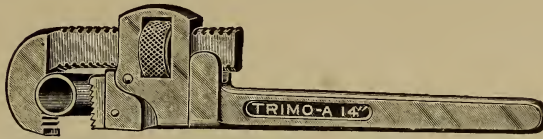

Code	Merendamo	Mergachte	Mergelnut	Mergende	Mergitand	Merguloro	Mericarte	Meridiano
Length, inches.....	6	8	10	14	18	24	†36	†48
Takes from	1/8-in. wire	1/8-in. wire	1/8-in. wire	1/4-in. wire	1/4-in. wire	1/4-in. wire	1/2-in. pipe	1-in. pipe
	to	to	to	to	to	to	to	to
	1/2-in. pipe	3/4-in. pipe	1-in. pipe	1 1/2-in pipe	2-in. pipe	2 1/2-in. pipe	3 1/2-in. pipe	5-in. pipe
Each.....	\$2.00	2.00	2.25	3.00	4.00	6.00	12.00	18.00
Weight each, lbs	1	1 1/4	2	4 1/4	6 3/4	10 1/2	23 1/3

Jaws for Trimo Wrenches.

Code.....	Merigarter	Merismate	Merkmale	Merlatate	Merlinant	Mermodine	Merodista	Meropidan
Each	\$0.75	.75	.80	1.00	1.33	2.10	4.75	7.25

Insert Jaws for Trimo Wrenches.

Code	Merrimac	Merryren	Mersanto	Mersitabo	Mersitema	Mertaredum	Merulente	Mesallion
Each	\$0.33	.33	.40	.55	.65	.75	1.10	1.40

† Nuts for Trimo Wrenches.

Code.....	Mesarfeld	Mescoland	Mesianism	Mesmerist	Mesocrat	Mesogaste	Mesolithic	Mesomela
Each	\$0.11	.11	.14	.17	.22	.35	.55	.95

† Frames for Trimo Wrenches.

Code.....	Mesopodi	Mesorchis	Messapius	Messemark	Mestarden	Mestichin	Mestizaro	Mestolind
Each.....	\$0.35	.35	.40	.50	.55	.80	1.30	1.50

† STILLSON PIPE WRENCHES.

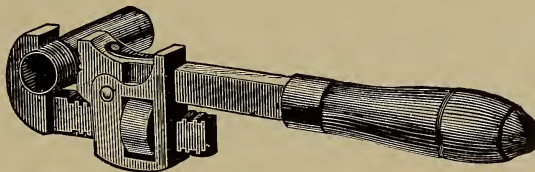

Code.....	Metabate	Metacenton	Metacisto	Metaforic	Metafrase	Metagogic
Length, inches.....	6	8	10	14	18	24
Takes from	1/8-in. wire	1/8-in. wire	1/8-in. wire	1/4-in. wire	1/4-in. wire	1/4-in. wire
	to	to	to	to	to	to
	1/2-in. pipe	3/4-in. pipe	1-in. pipe	1 1/2-in. pipe	2-in. pipe	2 1/2-in. pipe
Each.....	\$2.00	2.00	2.25	3.00	4.00	6.00
Weight each, lbs.....	1/2	1	1 1/2	3 1/6	5 1/2	8

6 to 14-inch Wrenches have Wood Handles; 18 and 24-inch Wrenches have all Iron Handles.

Jaws for Stillson Wrenches.

Code	Metagram	Metalino	Metallade	Metallisco	Metalogic	Metaponder
Each	\$0.75	.75	.80	1.00	1.33	2.10

Nuts for Stillson Wrenches.

Code	Metasomis	Metathora	Metellust	Meteoric	Metesilla	Metharmic
Each	\$0.11	.11	.14	.17	.22	.35

Frames for Stillson Wrenches.

Code.....	Methglos	Methocamp	Methodist	Methodoro	Methulent	Methylate
Each	\$0.35	.35	.40	.50	.55	.80

† Carried in San Francisco only.

† **WRIGHT'S PIPE WRENCHES.**

POLISHED STEEL. DISENGAGES ITSELF BY REMOVING PRESSURE FROM LEVER HANDLE.

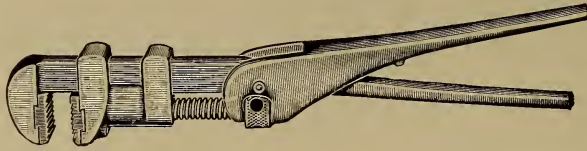

Code	Metochist	Metodico	Metoparis
Length, inches	13	16	24
Opens, inches.....	1¾	2⅝	3½
Each	\$3.00	4.00	7.50
Weight each, lbs.....	2½	4	9

Loose.

† **ATLAS PIPE WRENCHES.**

MADE OF SPECIAL WRENCH STEEL. NO THREADS TO STRIP. NO NUTS TO JAM. NO SCREW JAWS TO BREAK.



Code.....	Metrical	Metrodar	Metrodoric	Metropolit
Length, inches	10	18	24	36
Takes from	½-in. wire to 1-in. pipe	¼-in. pipe to 2-in. pipe	½-in. pipe to 3-in. pipe	1-in. pipe to 4½-in. pipe
Each	\$2.25	4.00	6.00	12.00
Weight each, lbs.....	2	4	10	23

Loose.

† **SHEFFY PIPE WRENCHES.**

JESSOP STEEL DOGS. BLACK DIAMOND STEEL JAWS. BESSEMER STEEL HANDLES. EVERY WRENCH GUARANTEED. QUICK ACTION. SELF-ADJUSTING. NO SCREWS. NO SPRINGS. DISENGAGES ITSELF BY REVERSING PRESSURE ON HANDLE.



Code	Mettilord	Meublast	Meublou
Numbers.....	0	2	4
Length, inches.....	7	12	18
Takes pipe, inches.....	⅛ to ½	⅛ to 1	¼ to 2
Each.....	\$2.00	2.25	4.00
Weight each, lbs.....	½	2	5

† Carried in San Francisco only.

ELGIN ADJUSTABLE WRENCHES.

FOR PIPE OR NUTS. STEEL. FULLY NICKEL-PLATED. BOTH JAWS HARDENED. WILL TAKE FROM 1/8-INCH WIRE TO 3/4-INCH PIPE, OR A NUT THAT IS 1 1/2 INCHES ACROSS.

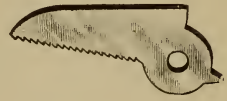
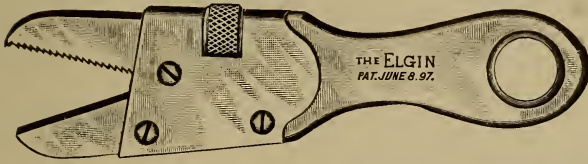

Code	Menlards
Length, inches.....	7
Per dozen.....	\$12.00
Weight per doz., lbs.....	7 1/2

One-half dozen in a box.

† Extra Jaws for Elgin Wrenches.

Code	Mexenofa
Per dozen.....	\$3.00

† **ALLIGATOR WRENCHES.**

FORGED STEEL, WITH HARDENED JAWS.



Code.....	Mezquita	Mezzadrom	Mezzobust	Mezzotinte	Miaduram	Miagoland
Numbers	Pocket	Twin	1	2	3	4
Length, inches.....	10	5 3/4	10	16	22	22
Hold pipe, inches.....	1/8 to 1/4	1/8 to 3/4	1/8 to 3/8	3/8 to 3/4	1/2 to 1 1/4	1 1/4 to 2
Hold round iron, inches.....	1/2	1/4 to 1	1/4 to 3/4	1/2 to 1	3/4 to 1 3/8	1 1/2 to 2 1/2
Per dozen.....	\$3.00	18.00	4.00	12.00	24.00	36.00
Weight per doz., lbs	1 1/2	3	12	36	86

Pocket has steel screw driver at one end. Twin has wrench at both ends.

Pocket and No. 1, bright; balance, black. Pocket and No. 1, one dozen in a box.

† **BLACK SCREW WRENCHES.**

WROUGHT IRON BAR, HEAD AND SCREW.

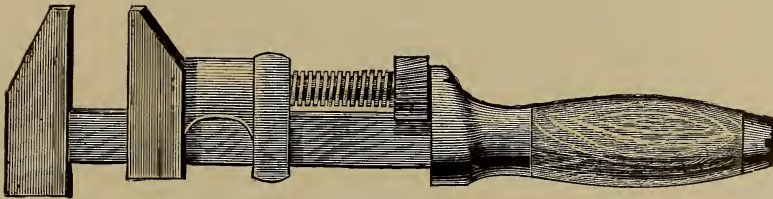

Code.....	Miasmatic	Micantibo	Michaela	Michordi	Micrasten
Length, inches.....	8	10	12	15	18
Per dozen.....	\$10.00	12.00	14.00	24.00	30.00
Weight per doz., lbs.....	15	20	26	40	60

8 to 12-inch, one-half dozen; 15 and 18-inch, one-third dozen in a box.

† Carried in San Francisco only.

† **McKERCHER WRENCHES.**

MADE OF BEST DROP FORGINGS AND MALLEABLE IRON. SIMPLE, STRONG AND DURABLE. ONLY THREE PARTS, HANDLE, JAW AND SPRING.

Assembled or taken apart as easily as a watch is wound, adjusted in a second, and so proportioned that it carries the strain equally.

No nuts or screws to stick and bind. Disengages itself by reversing pressure on handle.

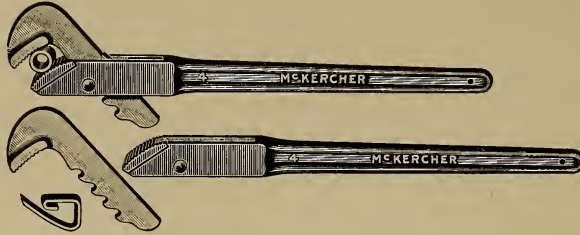

Code	Micrastepp	Micrasterb	Micrasterz	Micrastick	Micrastime	Micrasturp
Length, inches	6	10	14	18	24	36
Takes pipe, inches	1/8 to 3/4	1/8 to 1	1/4 to 1 1/2	3/8 to 2	1/2 to 2 1/2	1 to 4
Each.....	\$2.00	2.25	3.00	4.00	6.00	12.00
Weight each, pounds.....	3/4	1	2 1/4	4 1/4	8	17

Jaws for McKercher Wrenches.

Code	Micrasudd	Micrasuet	Micraswat	Micraswaye	Micratable	Micratade
Each	\$0.75	.80	1.00	1.40	2.50	4.00

Shoes or Small Jaws for McKercher Wrenches.

Code	Micratamp	Micratandy	Micratanke	Micrataper	Micratarz
Each	\$0.50	.65	1.10	1.50	2.50

Handle Including Shoe for McKercher Wrenches.

Code	Micrateems	Micrategg	Micratimbo	Micratizer	Micratoast	Micratobey
Each	\$1.50	1.75	2.00	3.00	4.50	9.00

Springs for McKercher Wrenches.

Code	Micratodd	Micreate	Micrebber	Micredanze	Micredapel	Micredatti
Each.....	\$0.20	.25	.35	.45	.60	.80

† **THE YANKEE JAWS.**

CONVERTS AN ORDINARY WRENCH INTO A PIPE WRENCH. MADE FROM HIGH GRADE STEEL. ANY MECHANIC WILL SEE THEIR VALUE AT ONCE.

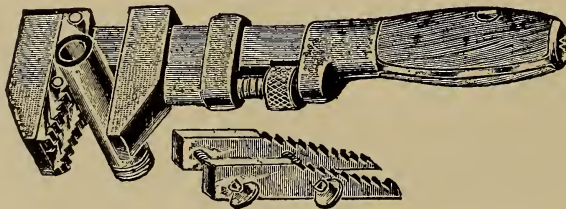

Cut shows Jaw and Jaw Applied.

Code	Micrefatal	Micrefurze
Numbers	2	1
To fit wrenches, inches	Up to 16	16 to 26
Per dozen	\$3.70	4.00
Weight per dozen, lbs	3 3/4	6 1/4

One dozen in a box.

† Carried in San Francisco only.

† **HEADSON AUTOMATIC PIPE WRENCH.**

MADE OF BEST DROP FORGE TOOL STEEL.

IT IS MACHINED AND TEMPERED.

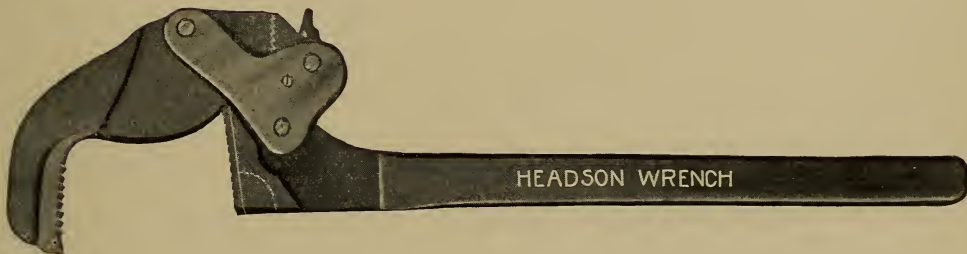

(Patent Pending.)

Code.....	Micregalt	Micreguss	Micrehap	Micrehope
Size, inches	10	14	18	24
Takes from.....	{ 1/8-in. wire to 1 1/4-in. pipe	{ 1/4-in. wire to 2-in. pipe	{ 1/4-in. wire to 2 1/2-in. pipe	{ 1/4-in. wire to 3-in. pipe
Each.....	\$2.25	3.00	4.00	6.00
Weight each, lbs	1 7/8	4	6 1/2	10

A PERFECT PIPE WRENCH.

The only perfect automatic pipe wrench; it is absolutely free from all screw adjustment. It adjusts itself instantly to any size pipe. It never slips, never crushes, never sticks and is easily operated. It has an inserted jaw in the handle, which can be replaced, and every part of this wrench is made interchangeable. On large-sized pipe, instead of having the jaws overhanging as in the ordinary wrench, the pull is equal on both jaws, consequently making it a very strong and durable wrench. The parts are all made of the very best drop forge steel.

To operate this wrench in the position it now stands you merely move the handle forward and it adjusts itself to the pipe. To open wrench, disengage the sprawl which is fulcrumed from a perfect center, and it opens immediately to the full size of the wrench.

† Carried in San Francisco only

† **WARNOCK WRENCHES.**

DROP FORGED AND SELECTED STOCK WITH LINEN STRAP. POLISHED PIPE, SHAFTS, TUBING
ALL GRIPPED SECURELY WITHOUT A MARK. ADJUST THEMSELVES
TO EVERY SIZE INSTANTLY.

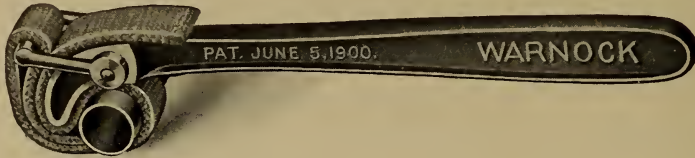

Code.....	Microreturn
Length, inches.....	10
Takes pipe, inches.....	1/8 to 2
Each.....	\$1.50
Weight each, lbs.....	1 1/2

One-half dozen in a box.

Extra Straps.

Code.....	Microvim
Each.....	\$0.25

† **BUZZELL'S BASIN WRENCHES.**



Code.....	Microbes
Per dozen.....	\$22.00
Weight per doz., lbs.....	18

Loose.

† **TRIMO BASIN WRENCHES.**

This Wrench can be used in closer quarters than any other Wrench of its kind. Can be operated with one hand. Parts interchangeable.

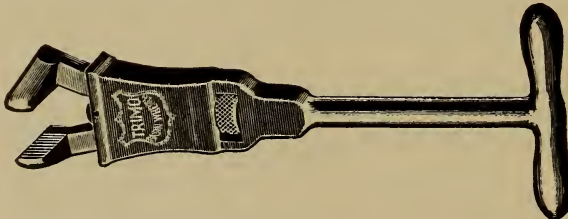

Code.....	Microdet
Length, inches.....	10
Per dozen.....	\$22.50
Weight per doz., lbs.....	16

EXTRAS:

Jaws, each.....	\$0.75	Springs, each.....	\$0.15
Nuts, each.....	.30	Screws, each.....	.30

† Carried in San Francisco only.

† **PLUMBERS' FORCE PUMPS.**

FITTED FOR HOSE.

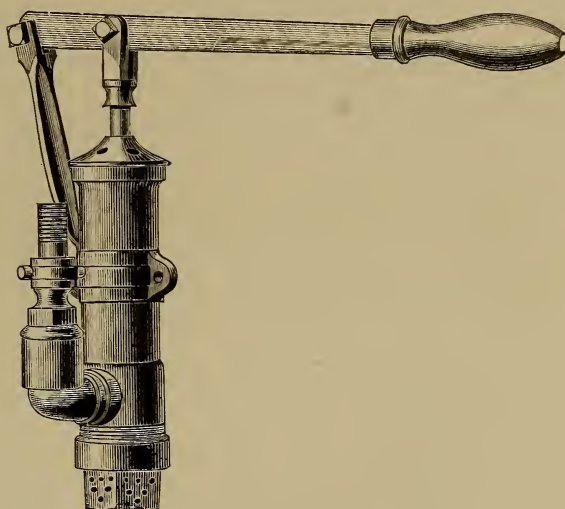

Fig. 217.

This is a very powerful Force or Pressure Pump. The cylinder and working parts are of cast brass. The Pump is usually placed in a pail of water when used and connected with the pipe to be cleaned by hose.

Code.....	Micrometer
Figure	217
Diameter, inches.....	2
Length of stroke, inches.....	5
Capacity per stroke, gallon.....	1/4
Each.....	\$10.00
Weight each, lbs.....	12

† **PLUMBERS' HANDY FORCE PUMPS.**

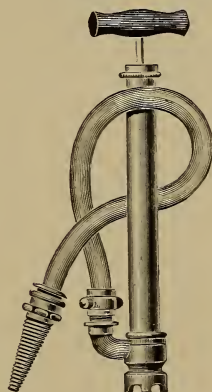

Fig. 373.

The cut shows a very compact form of Plumbers' Force Pump, which meets the requirements of the practical plumbing trade. This Pump is made entirely of brass and is designed to be placed in a pail. By its use a great pressure may be put upon pipes for cleaning out obstructions. It is fitted with three feet of hose and conical tip, so that it can be readily connected with any ordinary sized pipe or fixture. The form of the Pump renders it more convenient for carrying in a sack of plumbers' tools than any Pump having a projecting handle.

Code.....	Miculare
Figure.....	373
Each	\$7.00
Weight each, lbs.....	6

† Carried in San Francisco only.

† PLUMBERS' FORCE PUMPS.

FITTED FOR HOSE.

The cut shows a powerful Plumbers' Force Pump, the cylinder and working parts being entirely of brass.

It is provided with a strong iron stirrup, and has couplings for 3/4-inch hose.

Code.....	Midasian
Figure.....	425
Diameter of cylinder, inches.....	2
Length of stroke, inches.....	5
Capacity per stroke, gallon.....	.07
Each	\$15.00
Weight each, lbs.....	17

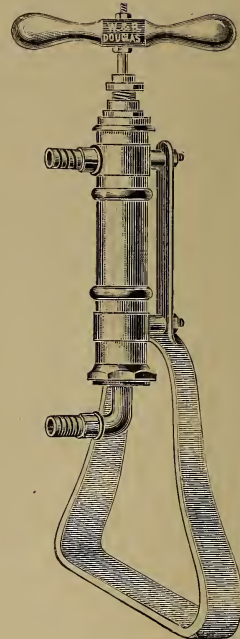

Fig. 425.

† GAS MAIN FORCE PUMP OR SERVICE CLEANER.

This pump is superior to any other on the market, having metal valves, thereby increasing its durability, and is by all means the best pump for cleaning waste and service pipes.

The chamber of the pump is made of seamless brass tubing, size 2 1/8x12 inches, and the air reservoir of extra heavy copper, size 8x10 inches; with stop cock and 3/4-inch hose coupling. Extreme height, 25 inches.

Code.....	Midault
Number.....	99
Each.....	\$33.00
Weight each, lbs.....	17

† Carried in San Francisco only.

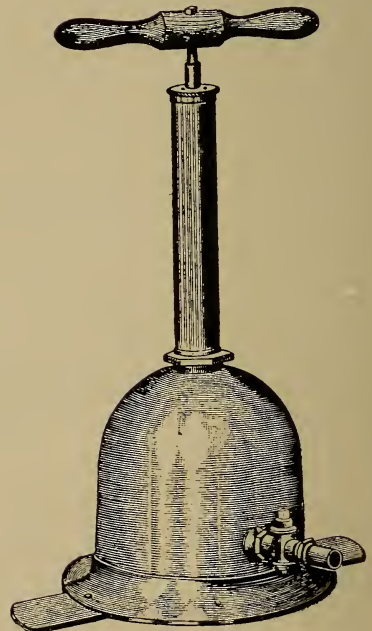

† **IMPROVED TESTING PUMPS.**

(Patent applied for.)

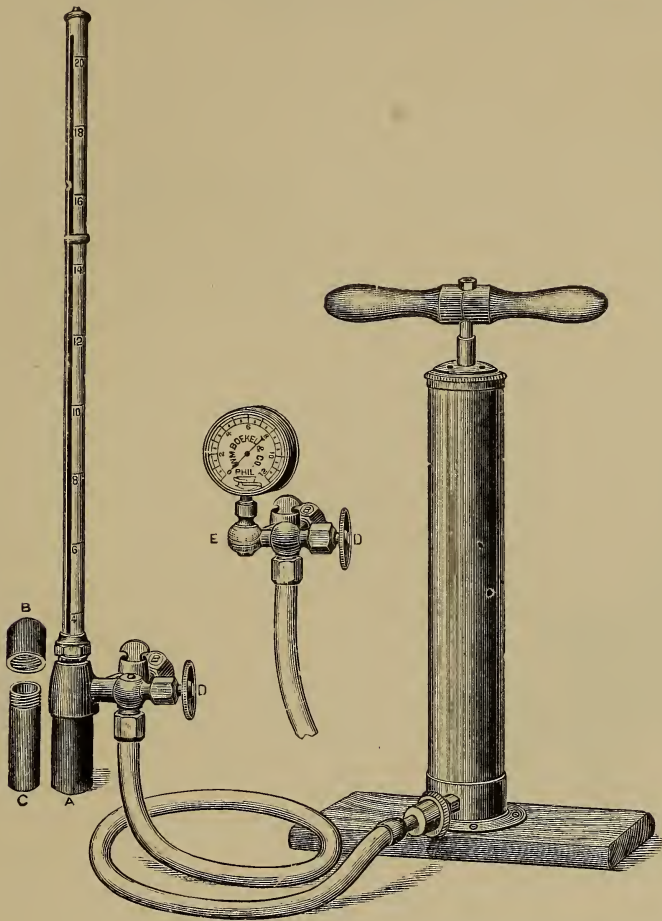

The above cut illustrates our Gas-fitters' Test Pump, combined with our Improved Mercury and Spring Test Gauges.

The Mercury Test Gauge consists of a Mercury Cup, Ether Cup, Stop Cock and Mercury Column.

A—The Mercury Cup is made of iron, and screws into the lower part of the Gauge; when not in use it can easily be unscrewed and closed with the screw cap, *B*, to prevent loss of mercury.

C is a piece of gas pipe to attach in place of the Mercury Cup, when the latter is taken off, to protect the projecting glass tube.

D is a Stop Cock to shut off the air.

Our Mercury Test Gauges are made in the best and most durable manner and superior to all others, for the following reasons:

First. The Mercury Cup is at the bottom of the Gauge, and is readily unscrewed, closed with the screw cap and put in the bag with other tools. The old method of taking the cup out of the chamber, pouring the mercury into a bottle and carrying it in the pocket, is thus done away with.

Second. The Mercury Cup being at the bottom, there is no chance for the mercury to spill over the brass parts and destroy them.

Third. For greater convenience we have graduated the column, which we consider a decided improvement. The Pump has most excellent metal valves, and is particularly well adapted for the purpose. The Spring Test Gauge is neatly made, the Gauge itself being 2½ inches in diameter.

Code.....	Middagast	Middelbog	Middelmate
Each.....	Pump with Hose Coupling	Spring Test Gauge	Mercury Test Gauge
Weight each, lbs.....	\$5.00	3.50	4.50
	5¼	2¾	2½

Extra Gauge Glasses.

Code.....	Middendo
Length, inches.....	22½
Diameter of gauge glass, inch.....	¾
Each.....	\$0.50

† Carried in San Francisco only.

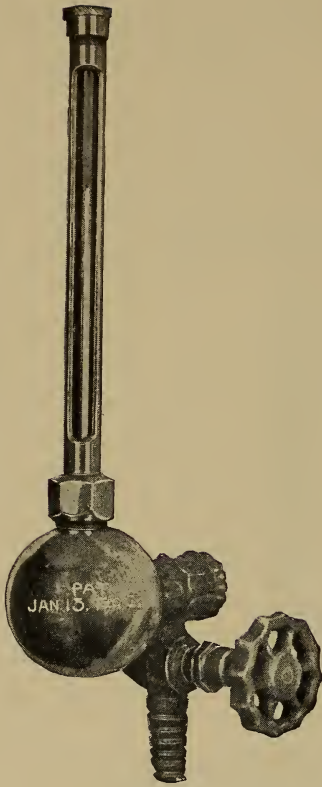

SPENCER & FISHER'S MERCURY TEST GAUGES.

BRASS NICKEL-PLATED. HIGH OR LOW
PRESSURE

Simple. Accurate. Reliable. Every Gauge is tested before leaving the factory. Pour 5 ounces of Mercury in the $\frac{3}{8}$ -inch opening and the gauge is ready for operation. Turn the Gauge in any position and the Mercury will not spill.

Code.....	Middinto	Middling
Style.....	Short	Long
Each.....	\$4.00	4.00
Weight each, lbs.....	1 $\frac{3}{8}$	1 $\frac{3}{8}$

Extra Gauge Glasses.

Code.....	Midlamp	Midlander
Style.....	Short	Long
Length, inch.....	10 $\frac{1}{2}$	13 $\frac{1}{2}$
Diameter, inch.....	$\frac{5}{16}$	$\frac{5}{16}$
Each.....	\$.....

U. S. GALLONS IN ROUND TANKS.

For One Foot in Depth.

Diameter of Tanks.	No. U. S. Gals.	Cubic Feet and Area in Sq. Feet.	Diameter of Tanks.	No. U. S. Gals.	Cubic Feet and Area in Sq. Feet.	Diameter of Tanks.	No. U. S. Gals.	Cubic Feet and Area in Sq. Ft.
1 ft.	5.87	.785	5 ft. 8 in.	186.66	25.22	19 ft.	2120.90	283.53
1 1 in.	6.89	.922	5 9	194.25	25.97	19 3 in.	2177.10	291.04
1 2	8.	1.069	5 10	199.92	26.73	19 6	2234.	298.65
1 3	9.18	1.227	5 11	205.67	27.49	19 9	2291.70	306.35
1 4	10.44	1.396	6	211.51	28.27	20	2350.10	314.16
1 5	11.79	1.576	6 3	229.50	30.68	20 3	2409.20	322.06
1 6	13.22	1.767	6 6	248.23	33.18	20 6	2469.10	330.06
1 7	14.73	1.969	6 9	267.69	35.78	20 9	2529.60	338.16
1 8	16.32	2.182	7	287.88	38.48	21	2591.	346.36
1 9	17.99	2.405	7 3	308.81	41.28	21 3	2653.	354.66
1 10	19.75	2.640	7 6	330.48	44.18	21 6	2715.80	363.05
1 11	21.58	2.885	7 9	352.88	47.17	21 9	2779.30	371.54
2	23.50	3.142	8	376.01	50.27	22	2843.60	380.13
2 1	25.50	3.409	8 3	399.88	53.46	22 3	2908.60	388.82
2 2	27.58	3.687	8 6	424.48	56.75	22 6	2974.30	397.61
2 3	29.74	3.976	8 9	449.82	60.13	22 9	3040.80	406.49
2 4	31.99	4.276	9	475.89	63.62	23	3108.	415.48
2 5	34.31	4.587	9 3	502.70	67.20	23 3	3175.90	424.56
2 6	36.72	4.909	9 6	530.24	70.88	23 6	3244.60	433.74
2 7	39.21	5.241	9 9	558.51	74.66	23 9	3314.	443.01
2 8	41.78	5.585	10	587.52	78.54	24	3384.10	452.39
2 9	44.43	5.940	10 3	617.26	82.52	24 3	3455.	461.86
2 10	47.16	6.305	10 6	640.74	86.59	24 6	3526.60	471.44
2 11	49.98	6.681	10 9	678.95	90.76	24 9	3598.90	481.11
3	52.88	7.069	11	710.90	95.03	25	3672.	490.87
3 1	55.86	7.467	11 3	743.58	99.40	25 3	3745.80	500.74
3 2	58.92	7.876	11 6	776.99	103.87	25 6	3820.30	510.71
3 3	62.06	8.296	11 9	811.14	108.43	25 9	3895.60	520.77
3 4	65.28	8.727	12	846.03	113.10	26	3971.60	530.93
3 5	68.58	9.168	12 3	881.65	117.86	26 3	4048.40	541.19
3 6	71.97	9.621	12 6	918.	122.72	26 6	4125.90	551.55
3 7	75.44	10.085	12 9	955.09	127.68	26 9	4204.10	562.
3 8	78.99	10.559	13	992.91	132.73	27	4283.	572.66
3 9	82.62	11.045	13 3	1031.50	137.89	27 3	4362.70	583.21
3 10	86.33	11.541	13 6	1070.80	143.14	27 6	4443.10	593.96
3 11	90.13	12.048	13 9	1110.80	148.49	27 9	4524.30	604.81
4	94.	12.566	14	1151.50	153.94	28	4606.20	615.75
4 1	97.96	13.095	14 3	1193.	159.48	28 3	4688.80	626.80
4 2	102.	13.635	14 6	1235.30	165.13	28 6	4772.10	637.94
4 3	106.12	14.186	14 9	1278.20	170.87	28 9	4856.20	649.18
4 4	110.32	14.748	15	1321.90	176.71	29	4941.	660.52
4 5	114.61	15.321	15 3	1366.40	182.65	29 3	5026.60	671.96
4 6	118.97	15.90	15 6	1411.50	188.69	29 6	5112.90	683.49
4 7	123.42	16.50	15 9	1457.40	194.83	29 9	5199.90	695.13
4 8	127.95	17.10	16	1504.10	201.06	30	5287.70	706.86
4 9	132.56	17.72	16 3	1551.40	207.39	30 3	5376.20	718.69
4 10	137.25	18.35	16 6	1599.50	213.82	30 6	5465.40	730.62
4 11	142.02	18.99	16 9	1648.40	220.35	30 9	5555.40	742.64
5	146.88	19.63	17	1697.90	226.98	31	5646.10	754.77
5 1	151.82	20.29	17 3	1748.20	233.71	31 3	5737.50	766.99
5 2	156.83	20.97	17 6	1799.30	240.53	31 6	5829.70	779.31
5 3	161.93	21.65	17 9	1851.10	247.45	31 9	5922.60	791.73
5 4	167.12	22.34	18	1903.60	254.47	32	6016.20	804.25
5 5	172.38	23.04	18 3	1956.80	261.59	32 3	6110.60	816.86
5 6	177.72	23.76	18 6	2010.80	268.80	32 6	6205.70	829.58
5 7	183.15	24.48	18 9	2065.50	276.12	32 9	6301.50	842.39

31½ Gallons equals 1 Barrel.

To find the capacity of tanks greater than the largest given in the table, look in the table for a Tank of one-half of the given size and multiply its capacity by 4, or one of one-third its size and multiply its capacity by 9, etc.

CAPACITY OF CANS ONE INCH DEEP.

UTILITY OF TABLE.

Required the contents of a vessel, diameter $6\frac{7}{10}$ inches, depth 10 inches:

By the table, a vessel 1 inch deep, and $6\frac{7}{10}$ inches diameter, contains .15 of a gallon; then $15 \times 10 = 1.50$, or 1 gallon and 2 quarts.

Required the contents of a can, diameter $19\frac{8}{10}$ inches, depth 30 inches:

By the table, a vessel 1 inch deep, and $19\frac{8}{10}$ inches diameter, contains 1.33 gallons; then $1.33 \times 30 = 39.90$, or nearly 40 gallons.

Required the depth of a can whose diameter is $12\frac{2}{10}$ inches, to contain 16 gallons:

By the table, a vessel 1 inch deep, and $12\frac{2}{10}$ inches diameter, contains .50 of a gallon; then $16 \div .50 = 32$ inches, the depth required, viz.:

$$.50)16(32 \times .50 = 16 \text{ gallons.}$$

Diameter, Inches.	$\frac{1}{10}$	$\frac{2}{10}$	$\frac{3}{10}$	$\frac{4}{10}$	$\frac{5}{10}$	$\frac{6}{10}$	$\frac{7}{10}$	$\frac{8}{10}$	$\frac{9}{10}$	
3	.030	.030	.030	.030	.030	.040	.040	.040	.040	.050
4	.050	.040	.050	.050	.060	.060	.070	.070	.070	.080
5	.080	.080	.080	.090	.090	.100	.100	.110	.110	.110
6	.120	.120	.120	.130	.130	.140	.140	.150	.150	.160
7	.160	.170	.170	.180	.180	.190	.190	.200	.200	.210
8	.210	.220	.220	.230	.230	.240	.250	.250	.260	.260
9	.270	.280	.280	.290	.300	.300	.310	.310	.320	.330
10	.340	.340	.350	.360	.360	.370	.380	.380	.390	.400
11	.410	.410	.420	.430	.440	.440	.450	.460	.470	.480
12	.480	.490	.500	.510	.520	.530	.530	.540	.550	.560
13	.570	.580	.590	.600	.600	.610	.620	.630	.640	.650
14	.660	.670	.680	.690	.700	.710	.720	.730	.740	.750
15	.760	.770	.780	.790	.800	.810	.820	.830	.840	.850
16	.870	.880	.890	.900	.910	.920	.930	.940	.950	.970
17	.980	.990	1.005	1.017	1.028	1.040	1.051	1.063	1.075	1.086
18	1.101	1.113	1.125	1.138	1.150	1.162	1.170	1.187	1.200	1.211
19	1.227	1.240	1.253	1.266	1.279	1.292	1.304	1.317	1.330	1.343
20	1.360	1.373	1.385	1.400	1.414	1.428	1.441	1.455	1.478	1.482
21	1.499	1.513	1.527	1.542	1.556	1.570	1.585	1.600	1.612	1.630
22	1.645	1.660	1.675	1.696	1.705	1.720	1.735	1.750	1.770	1.780
23	1.798	1.814	1.830	1.845	1.861	1.876	1.892	1.908	1.923	1.940
24	1.958	1.974	1.991	2.007	2.023	2.040	2.056	2.072	2.096	2.105
25	2.125	2.142	2.159	2.176	2.193	2.210	2.227	2.244	2.261	2.280
26	2.298	2.316	2.333	2.351	2.369	2.386	2.404	2.422	2.440	2.460
27	2.478	2.496	2.515	2.533	2.552	2.570	2.588	2.607	2.625	2.643
28	2.665	2.684	2.703	2.722	2.741	2.764	2.780	2.800	2.820	2.836
29	2.859	2.879	2.898	2.918	2.938	2.958	2.977	2.997	3.017	3.036
30	3.060	3.080	3.100	3.121	3.141	3.162	3.182	3.202	3.223	3.245
31	3.267	3.288	3.309	3.330	3.351	3.372	3.393	3.414	3.436	3.457
32	3.481	3.503	3.524	3.543	3.568	3.590	3.612	3.633	3.655	3.689
33	3.702	3.725	3.747	3.773	3.795	3.814	3.837	3.860	3.882	3.904
34	3.930	3.953	3.976	4.003	4.022	4.046	4.070	4.092	4.115	4.140
35	4.165	4.188	4.212	4.236	4.260	4.284	4.307	4.331	4.355	4.380
36	4.406	4.430	4.455	4.483	4.503	4.528	4.553	4.577	4.602	4.626
37	4.654	4.679	4.704	4.730	4.755	4.780	4.805	4.834	4.855	4.880
38	4.909	4.935	4.961	4.987	5.012	5.038	5.064	5.090	5.120	5.142
39	5.171	5.197	5.224	5.250	5.277	5.304	5.330	5.357	5.383	5.410
40	5.440	5.467	5.491	5.521	5.548	5.576	5.603	5.630	5.657	5.684

CAPACITY OF CISTERNS.

IN GALLONS FOR EACH 10 INCHES IN DEPTH.

Diameter, Feet.	Gallons.	Diameter, Feet.	Gallons.	Diameter, Feet.	Gallons.	Diameter, Feet.	Gallons.
2	19.5	5½	148.1	9	396.56	15	1101.6
2½	30.5	6	176.25	9½	461.4	20	1958.4
3	44.6	6½	206.85	10	489.9	25	3059.9
3½	59.97	7	239.88	11	592.4	30	4406.4
4	78.33	7½	275.4	12	705.	35	5990.
4½	99.14	8	313.33	13	827.4	40	7831.
5	122.4	8½	353.72	14	959.6		

TO FIND THE SPECIFIC GRAVITY OF A SUBSTANCE.

W =Weight of body in air.

w =Weight of body in water.

$$\text{Specific gravity} = \frac{W}{W-w}$$

If the substance be lighter than water, sink it by means of a heavier substance, and deduct the weight of the heavier substance.

WEIGHT AND SPECIFIC GRAVITY OF VARIOUS MATERIALS.

Material.	Weight per Cu. Ft.	Specific Gravity.	Material.	Weight per Cu. Ft.	Specific Gravity.	Material.	Weight per Cu. Ft.	Specific Gravity.
Asphaltum.....	87	1.4	Earth, from.....	77	1.52	Millstone.....	155
Basalt.....	181	2.9	Earth, to.....	125	2.	Pitch.....	72	1.15
Brick, Com., from	100	1.6	Emery.....	250	Plaster Paris, Cast	80
Brick, Com., to...	125	2.	Flint.....	162	2.6	Plumbago.....	140	2.267
Brick, Pressed....	134	2.16	Glass, Flint.....	192	3.088	Porphyry.....	170	2.73
Brick, Fire.....	150	2.04	Glass, Common...	157	2.52	Pumice Stone.....	57
Brick, in Mortar..	110	Glass, Plate.....	172	2.76	Quartz.....	165	2.65
Brick, in Cement	112	Glass, Flooring ..	158	2.258	Sand, river.....	117	1.88
Cement, Port., loose....	78	Granite, Gray.....	163	2.262	Sand, coarse.....	100	1.61
Cement, Rose, loose....	60	Granite, Red.....	165	2.262	Sand Stone.....	150	2.4
Chalk, solid.....	145	2.33	Gutta Percha.....	60	.966	Slate, American...	175	2.8
Charcoal, Birch... 34	Gun Powder, coarse....	57	Slate, Welsh.....	180	2.88
Charcoal, Fir..... 28	Gun Powder, fine.....	56	Snow, fresh fallen	5 to 12
Charcoal..... 21	Gypsum.....	143	2.286	Snow, wet and compact-		
Charcoal, Pine.... 18	Ivory.....	114	1.82	ed by rain.....	15 to 20
Clay.....	119	1.9	Lime Stone.....	168	2.7	Sulphur.....	125
Coal, Anthracite.. 93.5	1.5	Lime, Quick.....	53	.843	Tallow.....	58.6	2.94
Coal, Bituminous 84	1.35	Marble.....	168	Tar.....	63	.016
Coal, Cannel..... 79	1.27	Masonry, Ashlar...	160	Trap.....	170	1.72
Coke..... 26	Masonry, Rubble..	180	Tile.....	115	2.85
Concrete, in Cement....	137	2.2	Mortar, average...	106	1.7	Wax, Bees.....	60.5	1.97

WEIGHT AND SPECIFIC GRAVITY OF TIMBER.

SEASONED.

Name	Wt. Per Cu. Ft. Aver'ge	Specific Gravity Aver'ge	Name	Wt. Per Cu. Ft. Aver'ge	Specific Gravity Aver'ge	Name	Wt. Per Cu. Ft. Aver'ge	Specific Gravity Aver'ge
Apple	49	.79	Ebony	74	1.187	Maple, Soft	42	.675
Ash.	47	.76	Elm.	35	.56	Oak, Live.....	60	.96
Beech	43	.696	Hemlock	25	.4	Oak, White.....	52	.83
Birch	45	.73	Hickory.....	53	.85	Oak, Red	45	.725
Box	60	.96	Horn' Beam.....	47	.76	Pine, White	25	.40
Cedar, West India	47	.748	Iron Wood.....	71	1.15	Pine, Yellow, Northern ...	35	.564
Cedar, American	35	.554	Larch	35	.556	Pine, Yellow, Southern.....	45	.72
Cedar, Lebanon..	30	.486	Lignumvitze	83	1.333	Sycamore.	37	.601
Cherry	42	.672	Mahogany Honduras.....	35	.56	Teak	46	.74
Chestnut	41	.66	Mahogany, Spanish	53	.582	Walnut.....	35	.56
Cork	15	.24	Maple, Rock.....	49	.79

AVERAGE WEIGHT AND SPECIFIC GRAVITY OF METALS.

Metals	Wt. Per Cu. Ft., Pounds	Wt. Per Cu. In., Pounds	Specific Gravity	Metals	Wt. Per Cu. Ft., Pounds	Wt. Per Cu. In., Pounds	Specific Gravity
Aluminum	166	.096	2.67	Iron, Wrought	480	.280	7.78
Antimony, Cast	419	.242	6.72	Lead, Cast.....	708	.408	11.36
Bismuth	613	.353	9.82	Lead, Rolled.....	711	.410	11.41
Brass, Cast.....	524	.300	8.40	Mercury	849	.489	13.60
Bronze.....	534	.308	8.56	Platinum.....	1344	.775	21.53
Copper, Cast.....	537	.310	8.62	Platinum, Sheet.....	1436	.828	23.00
Copper, Wire.....	555	.320	8.90	Silver, Pure.....	654	.377	10.47
Gold, 24 carat.	1208	.697	19.36	Silver, Standard....	644	.371	10.31
Gold, Standard.....	1106	.638	17.72	Steel	490	.284	7.85
Gun Metal.....	528	.304	8.26	Tin, Cast	455	.262	7.29
Iron, Cast.....	450	.260	7.21	Zinc.....	437	.252	7.00

AVERAGE WEIGHT AND SPECIFIC GRAVITY OF LIQUIDS.

Water.—The weight of fresh water is in practice usually assumed at 62½ pounds per cubic foot. But 62¼ would be nearer the truth at ordinary temperatures, about 70 degrees; or 1 pound =27.759 cubic inches.

Liquids	Specific Gravity	Wt. Per Cu. In., Pounds	Wt. Per Gallon	Liquids	Specific Gravity	Wt. Per Cu. In., Pounds	Wt. Per Gallon
Water, distilled 62° fahr..	1	.036	8.33	Honey.....	1.450	.052	12.00
Water, Sea.....	1.0300	.037	8.55	Milk.....	1.032	.037	8.55
Water, Dead Sea.....	1.2400	.045	10.40	Molasses	1.426	.050	11.66
Acid, Acetic	1.062	.038	8.78	Oil, Linseed940	.034	7.85
Acid, Nitric	1.217	.044	10.16	Oil, Olive.....	.915	.033	7.62
Acid, Sulphuric	1.841	.067	15.48	Oil, Turpentine870	.031	7.16
Acid, Muratic.....	1.200	.043	9.93	Oil, Whale.....	.923	.033	7.65
Alcohol, Pure.....	.792	.029	6.70	Naphtha.....	.848	.031	7.00
Alcohol, Proof.....	.916	.033	7.62	Petroleum878	.032	7.39
Alcohol, Commercial	.833	.030	6.93	Tar	1.015	.036	8.40
Cider.....	1.018	.036	8.40	Wines, Average.....	.998	.036	8.30

WEIGHTS OF LUMBER, ETC., DRY.

Articles	Weight, Pounds	Articles	Weight, Pounds
Flooring, D and M.....per 1000 feet	1800	Boards and Dimensions, rough.....per 1000 feet	2400
Siding, dressed.....per 1000 feet	800	Shingles.....per 1000 pieces	250
Ceiling, 3/8-inch thick.....per 1000 feet	800	Lath.....per 1000 pieces	450
Ceiling, 1/2-inch thick.....per 1000 feet	900	Pickets, rough.....per 1000 pieces	1800
Boards, dressed one side...per 1000 feet	2000	Pickets, dressed.....per 1000 pieces	2400

MISCELLANEOUS WEIGHTS.

Articles.	Weight, Pounds.	Articles.	Weight, Pounds.
Flour, barrel.....	196	Cement (Hy.), Rosedale, bushel.....	70
Salt, barrel.....	280	Cement (Hy.), Louisville, bushel.....	62
Beef, barrel.....	200	Cement (Hy.), Portland, bushel.....	96
Pork, barrel.....	200	Gypsum, ground, bushel.....	70
Fish, barrel.....	200	Lime, loose, bushel.....	70
Powder, keg.....	25	Lime, well shaken, bushel.....	80
Stone of Lead or Iron.....	14	Sand at 98 lbs. per cubic foot, bushel.....	122 1/2

18.29 bushels sand=ton. 1.18 tons=cubic yard.

Anthracite coal, broken, cubic foot averages 54 lbs.

A ton loose occupies 40 to 43 cubic feet.

Bituminous coal, broken, cubic foot averages 49 lbs.

A ton loose occupies 43 to 48 cubic feet.

TO DERIVE WEIGHT OF IRON.

The average weight of Wrought Iron is 480 lbs. per cubic foot.

To find the sectional area, given the weight per foot: Multiply by 3/10.

To find the weight per foot, given the sectional area: Multiply by 3/10.

For Round Iron the weight per foot may be figured by taking the diameter in 1/4 inches; square it and divide by 6.

Example: What is the weight per foot of 2-inch Round Iron? 2 inches=8 quarter inches. 8x8=64. 64÷6=10 2/3 lbs. per foot.

Example: What is the weight per foot of 3/4-inch Round Iron? 3/4 inch=3 quarter inches. 3x3=9. 9÷6=1 1/2 lbs. per foot.

TO ASCERTAIN THE WEIGHT OF COPPER.

Find the number of cubic inches in the piece, multiply by .3214, and the product will be the weight in pounds.

WEIGHT OF SHEET COPPER

Per Square Foot.

1/16 inch thick weighs	3 lbs. to the square foot.
1/8 " " " "	6 " " " "
1/4 " " " "	12 " " " "
1/2 " " " "	24 " " " "

PURE BLOCK TIN PIPE.

Weight per Foot.

Diameter, inch.....	$\frac{1}{8}$	$\frac{3}{16}$	$\frac{1}{4}$	$\frac{1}{2}$	$\frac{5}{16}$	$\frac{3}{8}$	$\frac{3}{8}$	$\frac{7}{16}$	$\frac{1}{2}$	$\frac{1}{2}$	$\frac{1}{2}$	$\frac{3}{4}$
Weight per foot, ounces.	1 $\frac{3}{4}$	2 $\frac{3}{4}$	3 $\frac{1}{2}$	8	6 $\frac{1}{2}$	4	7	7	10	8	6 $\frac{1}{2}$	11
Diameter, inches.....		$\frac{5}{8}$	$\frac{3}{4}$	$\frac{3}{4}$	1	1	1 $\frac{1}{4}$	1 $\frac{1}{4}$	1 $\frac{1}{2}$	1 $\frac{1}{2}$	2	2
Weight per foot, ounces.....		9	13	11	17	14	26	18	36	24	40	26

ALLOWANCES FOR SHRINKAGE OF CASTINGS.

Castings.	Per Lineal Foot, Inch.	Castings.	Per Lineal Foot, Inch.
Cast Iron.....	$\frac{1}{8}$	Tin.....	$\frac{1}{12}$
Brass.....	$\frac{3}{16}$	Zinc.....	$\frac{3}{16}$
Lead.....	$\frac{1}{8}$		

TABLE OF WEIGHTS.

Per Square Foot of Iron, Steel, Copper, Brass and Pure Aluminum in Sheets and Thickness in Decimals of an Inch.

By American Gauge (Brown & Sharpe's).

Gauge No.	Thickness in Decimals of an Inch.	WEIGHT OF PLATES PER SQUARE FOOT.				
		Wrought Iron, Lbs.	Steel, Lbs.	Copper, Lbs.	Brass, Lbs.	Pure Aluminum, Lbs.
1	.2900	10.84880	10.99340	13.10500	12.38200	4.17600
2	.2580	9.66110	9.78990	11.67100	11.02700	3.71520
3	.2300	8.60330	8.71800	10.39300	9.81920	3.31200
4	.2050	7.66160	7.76380	9.25520	8.74450	2.95200
5	.1820	6.82280	6.91370	8.24190	7.78700	2.62080
6	.1620	6.07580	6.15680	7.33950	6.93450	2.33280
7	.1450	5.41050	5.48260	6.53590	6.17520	2.08800
8	.1290	4.81840	4.88260	5.82060	5.49940	1.85760
9	.1150	4.29110	4.34830	5.18370	4.89760	1.65600
10	.1020	3.82090	3.87180	4.61560	4.36090	1.46880
11	.0907	3.40280	3.44820	4.11060	3.88380	1.30608
12	.0808	3.03030	3.07070	3.66060	3.45860	1.16352
13	.0120	2.69850	2.73450	3.25980	3.07990	1.03680
14	.0640	2.40320	2.43520	2.90300	2.74280	.92160
15	.0570	2.14010	2.16860	2.58520	2.44250	.80080
16	.0508	1.90580	1.93120	2.30210	2.17510	.73152
17	.0453	1.69710	1.71980	2.05010	1.93700	.65232
18	.0403	1.51140	1.53150	1.82570	1.72500	.58032
19	.0359	1.34590	1.36380	1.62580	1.53610	.51696
20	.0320	1.19850	1.21450	1.44780	1.36790	.46080
21	.0285	1.06730	1.08160	1.28930	1.21820	.41040
22	.0254	.95051	.96319	1.14820	1.08490	.36576
23	.0225	.84641	.85770	1.02250	.96604	.32400
24	.0201	.75375	.76380	.91053	.86028	.28944
25	.0179	.67125	.68020	.81087	.76612	.25776
26	.0160	.59775	.60572	.72208	.68223	.23040
27	.0142	.53231	.53941	.64303	.60755	.20448
28	.0127	.47404	.48036	.57264	.54103	.18288
29	.0113	.42214	.42777	.50994	.48180	.16272
30	.0100	.37594	.38095	.45413	.42907	.14400
Specific gravity.....		7.78000	7.80500	8.90000	8.40000	2.67000
Weight, per cubic foot.....		480.00000	490.00000	555.00000	524.00000	166.00000

The weights given in these tables are theoretically correct, but variations must be expected in practice.

For Table of Weights and Thickness of Iron Sheets, Standard Gauge, adopted by the United States, taking effect July 1, 1893, see page 675.

NUMBER U. S. STANDARD THREADS TO AN INCH.

Diameter, inches.....	¼	⅜	½	⅝	¾	⅞	1	1 ¼	1 ½	1 ¾	2
Number of threads.....	20	18	16	14	13	12	11	10	9	8	7
Diameter, inches.....	1 ⅜	1 ½	1 ⅝	1 ¾	1 ⅞	2	2 ¼	2 ½	2 ¾	3	3 ¼
Number of threads.....	6	6	5 ½	5	5	4 ½	4 ½	4	4	3 ½	3 ½

BAR AND SHEET LEAD.

Weight in Pounds.

Thickness or Diameter or Side, Inch.	Sheets per Square Foot.	Square Bars 1 Foot Long.	Round Bars 1 Foot Long.	Thickness or Diameter, or Side, Inches.	Sheets per Square Foot.	Square Bars 1 Foot Long.	Round Bars 1 Foot Long.
1/16	3.71	.020	.014	1 1/16	63.20	5.60	4.40
1/8	7.43	.079	.060	1 1/8	66.87	6.26	4.91
3/16	11.00	.175	.136	1 3/16	70.51	6.98	5.50
1/4	14.80	.310	.245	1 1/4	74.35	7.74	6.10
5/16	18.05	.486	.380	1 5/16	78.05	8.55	6.73
3/8	22.20	.695	.549	1 3/8	84.76	9.38	7.38
7/16	26.00	.948	.745	1 7/16	85.48	10.18	8.05
1/2	29.75	1.250	.975	1 1/2	89.28	11.00	8.75
9/16	33.49	1.550	1.240	1 9/16	93.00	12.05	9.50
5/8	37.18	1.950	1.510	1 5/8	96.78	13.15	10.25
1 1/16	40.87	2.330	1.850	1 1 1/16	100.50	14.15	11.06
3/4	44.58	2.800	2.200	1 3/4	104.10	15.18	11.88
1 1/8	48.28	3.280	2.580	1 7/8	107.80	16.30	12.76
7/8	52.12	3.800	2.980	1 7/8	112.30	17.45	13.66
1 3/16	56.05	4.350	3.410	1 15/16	116.00	18.10	14.61
1	59.48	4.950	3.900	2	119.60	19.78	15.58

COPPER RIVETS AND BURRS.

Number in One Pound.

Length, inches.....	¼	⅜	½	⅝	¾	⅞	1	1 ¼	1 ½	1 ¾	2
No. 8.....	266	227	172	147	136	116	100	93	88	71	417
" 9.....	365	261	228	184	169	156	133	124	113	99	600
" 10.....	411	236	257	223	206	180	162	820
" 12.....	545	400	325	292	257	221	190	1167

MELTING POINT OF METALS.

Name.	Degrees Fahrenheit.	Name.	Degrees Fahrenheit.	Name.	Degrees Fahrenheit.
Antimony	1150	Lead	617	Sulphur.....	194
Bismuth	507	Mercury.....	-390	Steel.....	4000
Brass	1870	Iron, Cast.....	2780	Tin.....	442
Copper	1996	Iron, Wrought.....	4000	Zinc.....	773
Gold	2016	Silver.....	1830	Solder.....	441
Ice.....	+32				

FLUXES FOR BRAZING AND SOLDERING.

Metals.	Fluxes.
Cast Iron	} Borax } Sal Ammoniac
Malleable Iron	
Steel	
Copper	} Sal Ammoniac, } Chloride of Zinc } or Rosin
Brass	
Gun Metal	
Tinned Iron	Chloride of Zinc or Rosin
Lead with fine Solder	Rosin

VALUABLE PRACTICAL RECEIPTS AND COMPOSITIONS.

- Tinsmiths' Solder.**—Tin, one pound; lead, one pound.
- Plumbers' Solder.**—Tin, two pounds; lead, five pounds.
- Hard Solder.**—Copper, one pound; zinc, eight ounces.
- Solder for Gold.**—Gold, three pounds; silver, one pound; copper, one pound.
- Solder for Silver.**—Copper, two pounds; silver, one ounce; sheet brass, fifteen pounds.
- Solder for Britannia.**—Tin, seven pounds; lead, four pounds.
- Yellow Solder.**—Copper and zinc, equal parts.
- Black Solder.**—Copper, two pounds; zinc, two pounds; tin, four ounces.
- Yellow Brass.**—Zinc, ten pounds; lead, four ounces; copper, twenty-four pounds.
- Red Brass.**—Zinc, five pounds; lead, eight ounces; copper, twenty-four pounds.
- Bronze Metal.**—Zinc, two pounds; tin, one pound; copper, four pounds.
- Britannia Metal.**—Antimony, one pound; tin, one hundred pounds; copper, two pounds.
- Silver-Colored Metal.**—Tin, fifty pounds; bismuth, one pound; antimony, three pounds; copper three pounds.
- German Silver.**—Zinc, five pounds; copper, fourteen pounds; nickel, six pounds.
- Imitation Silver.**—Copper, four pounds; zinc, four ounces.
- Pinchbeck.**—Zinc, one pound; copper, four pounds.
- Tombac.**—Tin, one pound; zinc, one pound; copper, fifteen pounds.
- White Metal.**—Copper, five pounds; zinc, three pounds; lead, one pound; tin, one pound.
- Metal for Taking Impressions.**—Bismuth, three pounds; lead, one pound; tin, eight ounces.
- Rivet Metal.**—Tin, five pounds; zinc, two pounds; copper, ten pounds.
- Fusible Alloy** (which melts in hot water).—Bismuth, six ounces; tin, two ounces; lead, three ounces.
- A Metal that Extends in Cooling.**—Lead, nine parts; antimony, two parts; bismuth, four parts.
- Tinning Acid for Brass and Copper.**—Muriatic acid, one pound; give it all the zinc it will dissolve; add four ounces sal ammoniac, one pint water.
- For Tinning Brass.**—Water, four gallons; salt, one pint; cream tartar, one pound.
- Mixture for Silvering Metals.**—Dissolve two ounces of silver in three grains of corrosive sublimate; add salt, eight quarts; tartaric acid, four pounds.
- To Separate Silver from Copper.**—Sulphuric acid, one part; nitric acid, one part; water, one part; then boil the metal in the mixture until it dissolves; add a little salt, and the silver will subside.
- Speculum Metal.**—Copper, four pounds; tin, one pound; zinc, eight ounces.
- Common Pewter.**—Tin, four pounds; lead, one pound.
- Queen's Metal.**—Tin, nine pounds; antimony, one pound; lead, one pound; bismuth, one pound.
- Mock Platinum.**—Copper, four pounds; zinc, eighteen pounds.
- Mock Gold.**—Copper, sixteen pounds; platinum, seven pounds; zinc, one pound.
- Mankin Gold.**—Copper, three pounds; zinc, one pound; tin, four ounces.
- Type Metal.**—Lead, nine parts; antimony, two parts; bismuth, two parts; Chinese silver, two and five-tenths parts; copper, sixty-five and one-quarter parts; zinc, nineteen and one-half parts; nickel, thirteen parts; cobalt of iron, one-eighth part.
- Chinese White.**—Copper, forty and four-tenths parts; nickel, thirty-one and six-tenths parts; zinc, twenty-five and four-tenths parts; iron, two and six-tenths parts.
- Cement for Stopping Holes in Cast-Iron.**—Iron filings, fifteen parts; sal ammoniac, two parts; sulphur, one part; ground or powdered stone, two parts; add water until it is about the consistency of common paste; it is then ready for use.
- Acid for Soldering Tin.**—Muriatic acid, one part; add all the zinc it will dissolve; then add two parts water and a little sal ammoniac.
- Acid for Soldering Brass and Copper.**—Muriatic acid, one pound; zinc, four ounces; sal ammoniac, five ounces.
- Acid for Soldering Zinc.**—Muriatic acid, one pound; sal ammoniac, two ounces; all the zinc it will dissolve; water, three pints.
- Acid for Soldering Iron.**—Muriatic acid, one pound; sperm tallow, six ounces; sal ammoniac, four ounces.
- Acid for Soldering Gold and Silver.**—Muriatic acid, one pound; sperm tallow, eight ounces; sal ammoniac, eight ounces.

Practical Receipts and Compositions—Continued.

Cement for Coppersmiths.—Boiled linseed oil and red lead, mixed to the consistency of putty, is a good cement for stopping joints and cracks in copper pipe.

Cement, Invisible, for Glass, China, Earthen and Stoneware.—India-rubber, one part; chloroform, sixty parts; white shellac, six parts; gum mastic, twenty parts; shake frequently for two or three days and it will be ready for use.

Cement for Joining Metals to Wood, Leather and Glass.—Rosin, fifty parts; burnt umber, ten parts; calcined plaster, five parts; a little boiled oil improves it.

Cement for Joining Files.—Gum shellac, two parts; powdered chalk, one part; powdered and mixed. Place the cement on one end of the file, heat the other, press them firmly together and let them cool gradually.

Powder for Silvering Metals.—Nitrate of silver, ten parts; common salt, ten parts; cream tartar, thirty parts; moisten with water and apply.

Sealing Wax for Fruit Cans.—Beeswax, one part; rosin, ten parts; gum shellac, one part, coloring, according to taste; melt the rosin and beeswax at a low heat, then add the gum shellac, and last of all the coloring. If the cans are to be handled often, less rosin and more beeswax should be used.

To Coat Brass or Copper Vessels with Tin.—Boil the vessels in a solution of tin filings and chlorate of potassa, and they will in a few minutes become perfectly tinned. Care should be taken to have the vessels perfectly clean, otherwise the operation will be imperfectly performed.

Reliable Paste for Sticking on Tin.—To eight ounces flour, four ounces brown sugar, one ounce bicarb-soda, add five ounces cold water. Mix the above thoroughly until free from lumps. Then add one and one-half pounds boiling water and cook for a short time, continuously stirring. After the paste is made, and while still hot, add one-half ounce sulphuric acid.

Parting Sand.—Burnt sand scraped from the surface of castings.

Loam.—Mixture of brick, clay and old foundry sand.

Blackening for Moulds.—Charcoal powder; or, in some instances fine coal dust.

Black Wash.—Charcoal, plumbago and size.

Mixture for Welding Steel.—One sal ammoniac, ten borax, pounded together and fused until clear, when it is poured out, and after cooling, reduce to powder.

Rust-Joint Cement. (Quickly setting). One sal ammoniac in powder (by weight), two flour of sulphur, eighty iron borings made to paste with water.

Rust-Joint. (Slowly setting). Two sal ammoniac, one flour of sulphur, two hundred iron borings. The latter cement is the best if the joint is not required for immediate use.

Red-Lead Cement for Face Joints.—One of white lead, one of red lead mixed with linseed oil to the proper consistency.

Case-Hardening.—Place horn, hoof, bone-dust or shreds of leather together with the article to be case hardened, in an iron box subject to a blood-red heat, then immerse the article in cold water.

Case-Hardening with Prussiate of Potash.—Heat the article, after polishing, to a bright red, rub the surface over with prussiate of potash; allow to cool to dull red and immerse it in water.

Case-Hardening Mixtures.—Three prussiate of potash, one sal ammoniac, or, one prussiate of potash, two sal ammoniac, two bone-dust.

Glue to Resist Moisture.—One pound of glue melted in two quarts of skim milk.

Marine Glue.—One of india-rubber, twelve of mineral naphtha or coal tar. Heat gently, mix, and add twenty of powdered shellac. Pour out on a slab to cool. When used, to be heated to about two hundred and fifty degrees.

Glue Cement to Resist Moisture.—One glue, one black rosin, one-fourth red ochre, mixed with least possible quantity of water, or, four of glue or one oxide of iron, one of boiled oil (by weight).

To Remove Rust From Steel.—Steel which has been rusted can be cleaned by brushing with a paste compound of one-half ounce cyanide potassium, one-half ounce castile soap, one ounce whiting, and water sufficient to form a paste. The steel should be washed with a solution of one-half ounce cyanide potassium in two ounces water.

To Preserve Steel from Rust.—One caoutchouc, sixteen turpentine. Dissolve with a gentle heat, then add eight parts boiled oil. Mix by bringing them to the heat of boiling water; apply to the steel, with a brush, in the way of varnish. It may be removed with turpentine.

To Clean Brass.—One roche alum and sixteen water. Mix. The article to be cleaned must be made warm, then rubbed with the above mixture and finished with fine tripoli.

Materials and Labor per Square of Tin Roof—Continued.

20 x 28 Flat Seam Roofing.

Table showing the square feet of "flat seam" roof for any number of sheets of 20x28 tin plate from 1 to 1000; also, showing the number of sheets of 20x28 tin plate required to lay any given "flat seam" roof varying in size from 4 feet to 3562 feet. Size of tin, 20x28; edged, 27x19; square inches exposed, 513; sheets per box, 112.

No. Sheets.	Square Feet.	No. Sheets.	Square Feet.	No. Sheets.	Square Feet.	No. Sheets.	Square Feet.	No. Sheets.	Square Feet.	No. Sheets.	Square Feet.
1	4	20	71	38	135	56	199	74	264	92	328
2	7	21	75	39	139	57	203	75	267	93	331
3	10	22	78	40	143	58	207	76	271	94	335
4	14	23	82	41	146	59	210	77	274	95	338
5	18	24	86	42	150	60	214	78	278	96	342
6	21	25	89	43	153	61	217	79	281	97	346
7	25	26	93	44	157	62	221	80	285	98	349
8	29	27	96	45	160	63	224	81	289	99	353
9	32	28	100	46	164	64	228	82	292	100	356
10	36	29	103	47	167	65	232	83	296	200	713
11	39	30	107	48	171	66	235	84	299	300	1069
12	43	31	110	49	175	67	239	85	303	400	1425
13	46	32	114	50	178	68	242	86	306	500	1781
14	50	33	118	51	182	69	246	87	310	600	2138
15	53	34	121	52	185	70	249	88	314	700	2494
16	57	35	125	53	189	71	253	89	317	800	2850
17	61	36	128	54	192	72	256	90	321	900	3206
18	64	37	132	55	196	73	260	91	324	1000	3562
19	68										

20 x 28 Standing Seam Roofing.

Table showing the square feet of "standing seam" roof for any number of sheets of 20x28 tin plate from 1 to 1000; also, showing the number of sheets of 20x28 tin plate required to lay any given "standing seam" roof, varying in size from 3 feet to 3328 feet. Size of tin, 20x28; exposed n groove, 27x17¼; square inches exposed, 479½; sheets per box, 112.

No. Sheets.	Square Feet.	No. Sheets.	Square Feet.	No. Sheets.	Square Feet.	No. Sheets.	Square Feet.	No. Sheets.	Square Feet.	No. Sheets.	Square Feet.
1	3	20	67	38	126	56	186	74	246	92	306
2	7	21	70	39	130	57	190	75	250	93	309
3	10	22	73	40	133	58	193	76	253	94	313
4	13	23	77	41	136	59	196	77	256	95	316
5	17	24	80	42	140	60	200	78	259	96	319
6	20	25	83	43	143	61	203	79	263	97	323
7	23	26	86	44	146	62	206	80	266	98	326
8	27	27	90	45	150	63	210	81	269	99	329
9	30	28	93	46	153	64	213	82	273	100	333
10	33	29	96	47	156	65	216	83	276	200	656
11	37	30	100	48	160	66	220	84	280	300	998
12	40	31	103	49	163	67	223	85	283	400	1331
13	43	32	106	50	166	68	226	86	286	500	1664
14	47	33	110	51	170	69	230	87	289	600	1997
15	50	34	113	52	173	70	233	88	293	700	2330
16	53	35	116	53	176	71	236	89	296	800	2662
17	57	36	120	54	180	72	240	90	300	900	2925
18	60	37	123	55	183	73	243	91	303	1000	3328
19	63										

One box (112 sheets, 14x20) roofing tin will cover 170 square feet, allowing 1 inch for lock and 1¼ inches on each side of the sheet for standing groove.

One box (112 sheets, 20x28) will cover 360 square feet, after making same allowance for lock and groove.

SQUARE MEASURE.

Inches.	Feet.	Yards.	Rod, Pole or Perch.	Rood.	Acre.
144 =	1.00				
1296 =	9.00 =	1.00			
39204 =	272.25 =	30.25 =	1		
1568160 =	10890.00 =	12.10 =	40 =	1	
6272640 =	43560.00 =	4840.00 =	160 =	4 =	1

An acre is 69.57 yards square, or 208.7 feet square. A circular acre is 235.504 feet in diameter.
An acre is 1000 links square, or 10 square chains.

A township is 6 miles square=36 sections.

A section is 1 mile square=640 acres.

¼ section is ½ mile square=160 acres.

⅓ section is ¼ mile square=40 acres.

CUBIC MEASURE.

Cubic Inches.	Cubic Feet.	Cubic. Yard.
1728 =	1	
46656 =	27 =	1

A cubic foot of water weighs 62½ pounds.

A cubic foot of water contains 7½ gallons.

WOOD AND STONE MEASURE.

Cubic Feet.	
16 =	2 Cord Feet
128 =	8 Cord Feet = 1 Cord
24¾ =	1 Perch Masonry
96 =	1 Cord of Stone Masonry

GUNTER'S CHAIN.

Inches.	Links.	Chains.	Mile.
7.92 =	1		
792.00 =	100 =	1	
63360.00 =	8000 =	80 =	1

A Gunter's Chain is 66 feet long.

LONG MEASURE.

Inches.	Feet.	Yards.	Fathoms.	Rods.	Furlongs.	Mile.
12 =	1.0					
36 =	3.0 =	1.0				
72 =	6.0 =	2.0 =	1.00			
198 =	16.5 =	5.5 =	2.75 =	1		
7920 =	660.0 =	220.0 =	110.00 =	40 =	1	
63360 =	5280.0 =	1760.0 =	880.00 =	320 =	8 =	1

A degree=69⅓ miles.

NAUTICAL MEASURE.

Feet.	Fathoms.	Cable's Length.	Nautical Miles.	Leagues.	Degree.
6 =	1				
720 =	120 =	1			
6,086 =	1,014 $\frac{1}{3}$ =	8.452 =	1		
18,258 =	3,043 =	25.356 =	3 =	1	
365,160 =	60,860 =	507.66 $\frac{2}{3}$ =	60 =	20 =	1

60 nautical or geographical miles=1 degree=69.16 English miles.

MISCELLANEOUS.

- | | |
|-----------------------|-----------------------------|
| 12 lines=1 inch. | 240 yards=1 cable's length. |
| 3 barleycorns=1 inch. | 20 articles=1 score. |
| 3 inches=1 palm. | 12 dozen=1 gross. |
| 4 inches=1 hand. | 12 gross=1 great gross. |
| 18 inches=1 cubit. | |

INCHES AND THEIR EQUIVALENT DECIMAL VALUES IN PARTS OF A FOOT.

Inches.	Fraction of Foot.	Decimals Part of Foot.	Inches.	Fraction of Foot.	Decimals Part of Foot.
1	$\frac{1}{12}$.0833	7	$\frac{7}{12}$.5833
2	$\frac{1}{6}$.1667	8	$\frac{2}{3}$.6667
3	$\frac{1}{4}$.25	9	$\frac{3}{4}$.75
4	$\frac{1}{3}$.3333	10	$\frac{5}{6}$.8333
5	$\frac{5}{12}$.4167	11	$1\frac{1}{12}$.9167
6	$\frac{1}{2}$.5	12	1	1.0

FRACTIONAL PARTS OF AN INCH AND THEIR EQUIVALENT DECIMAL VALUES IN PARTS OF A FOOT.

Fractions of Inch.	Decimals of Foot.	Fractions of Inch.	Decimals of Foot.	Fractions of Inch.	Decimals of Foot.
$\frac{1}{16}$.0052	$\frac{7}{16}$.0365	$1\frac{3}{16}$.0677
$\frac{1}{8}$.0104	$\frac{1}{2}$.0417	$\frac{7}{8}$.0729
$\frac{3}{16}$.0156	$\frac{9}{16}$.0469	$1\frac{5}{16}$.0781
$\frac{1}{4}$.0208	$\frac{5}{8}$.0521	1	.0833
$\frac{5}{16}$.0260	$1\frac{1}{16}$.0573
$\frac{3}{8}$.0313	$\frac{3}{4}$.0625

LIQUID OR WINE MEASURE.

Gills.	Cu. In.	Pints.	Quarts.	Gallons.	Hogshead.	Pipe.	Tun.
1 =	7.2						
4 =	28.875 =	1					
8 =	57.75 =	2 =	1				
32 =	231.00 =	8 =	4 =	1			
2016 = =	504 =	252 =	63 =	1		
4032 = =	1008 =	504 =	126 =	2 =	1	
8064 = =	2016 =	1008 =	252 =	4 =	2 =	1

A barrel= 31 $\frac{1}{2}$ gallons.
 A gallon of fresh water weighs 8 $\frac{1}{3}$ pounds.

DRY MEASURE.

Pints.	Cubic Inches.	Quarts.	Gallons.	Pecks.	Bushel.
1	= 56.6				
2	= 67.2	= 1			
8	= 268.8	= 4	= 1		
16	= 537.6	= 8	= 2	= 1	
64	=	= 32	= 8	= 4	= 1

A bushel=2150.42 cubic inches. A cubic foot=.8 bushel.

To find the capacity of a Bin in bushels, multiply number of cubic feet by .8, and the result is the number of bushels.

AVOIRDUPOIS WEIGHT.

Drams.	Ounces.	Pounds.	Quarters.	Hundred-weights.	Ton.
16	= 1				
256	= 16	= 1			
6,400	= 400	= 25	= 1		
25,600	= 1,600	= 100	= 4	= 1	
512,000	= 32,000	= 2000	= 80	= 20	= 1

An ounce=437.5 grains Troy. A pound=1.2153 pounds Troy.

TROY WEIGHT.

Grains.	Penny-weights.	Ounces.	Pound.
24	= 1		
480	= 20	= 1	
5760	= 240	= 12	= 1

A pound Troy=22.816 cubic inches of distilled water.

APOTHECARY'S WEIGHT.

Grains.	Scruples.	Drams.	Ounces.	Pound.
20	= 1			
60	= 3	= 1		
480	= 24	= 8	= 1	
5760	= 288	= 96	= 12	= 1

APOTHECARY'S MEASURE.

Minims.	Fluid Drams.	Fluid Ounces.	Pints.	Gallon.
60	= 1			
480	= 8	= 1		
7,680	= 128	= 16	= 1	
61,440	= 1024	= 128	= 8	= 1

METRIC MEASURES OF LENGTH.

Millimetres.	Centimetres.	Decimetres.	Metres.	Dekametres.	Hectometres.	Kilometres.	Myriametres.
10 =	1 =	0.3937 in.					
100 =	10 =	1 =	3.937 in.				
1,000 =	100 =	10 =	1 = 3.2809 feet				
10,000 =	1,000 =	100 =	10 =	1 =	32.809 feet		
100,000 =	10,000 =	1,000 =	100 =	10 =	1 =	328.09 feet	
1,000,000 =	100,000 =	10,000 =	1,000 =	100 =	10 =	1 =	0.62137 miles
10,000,000 =	1,000,000 =	100,000 =	10,000 =	1,000 =	100 =	10 =	1 = 6.2137 miles

METRIC MEASURES OF SURFACE.

A table of metric measures of surface is obtained from the foregoing table by squaring the numbers, and placing the word "square" before each of the names, thus 100 square millimetres = 1 square centimetre.

Some Common Metric Denominations.

Hectare	=	10,000 square metres	=	2.471 acres.
Are	=	100 square metres	=	119.6 square yards.
Centare	=	1 square metre	=	10.7643 square feet.

METRIC MEASURES OF CAPACITY.

Milliliter.	Centiliter.	Deciliter.	Liter.	Dekaliter.	Hectoliter.	Kiloliter.
10 =	1					
100 =	10 =	1				
1,000 =	100 =	10 =	1			
10,000 =	1,000 =	100 =	10 =	1		
100,000 =	10,000 =	1,000 =	100 =	10 =	1	
1,000,000 =	100,000 =	10,000 =	1,000 =	100 =	10 =	1

Dry Measure.

1 Milliliter	=	.061 cubic inches
1 Centiliter	=	0.6102 " "
1 Deciliter	=	6.102 " "
1 Liter	=	0.908 quarts
1 Dekaliter	=	9.08 " "
1 Hektoliter	=	2. bushels and 3.35 pecks
1 Kiloliter	=	1.308 cubic yards

Wine Measure.

.27	fluid drams
.338	fluid ounces
0.845	gill
1.0567	quarts
2.6417	gallons
26.417	"
264.17	"

METRIC MEASURES OF WEIGHT.

Milligram.	Centigram.	Decigram.	Gram.	Dekagram.	Hektogram.	Kilogram.	Myriagram.	Quintal.	Millier.
10=	1								
100=	10=	1							
1,000=	100=	10=	1						
10,000=	1,000=	100=	10=	1					
100,000=	10,000=	1,000=	100=	10 =	1				
1,000,000=	100,000=	10,000=	1,000=	100 =	10 =	1			
10,000,000=	1,000,000=	100,000=	10,000=	1,000 =	100 =	10 =	1		
100,000,000=	10,000,000=	1,000,000=	100,000=	10,000 =	1,000 =	100 =	10 =	1	
1,000,000,000=	100,000,000=	10,000,000=	1,000,000=	100,000 =	10,000 =	1,000 =	100 =	10 =	1

Avoirdupois Weight.

1 Milligram	=	.0154 grains	.001 milliliter
1 Centigram	=	.1543 " "	.01 " "
1 Decigram	=	1.5432 " "	.1 " "
1 Gram	=	15.432 " "	1 " "
1 Dekagram	=	.3527 ounces	1 centiliter
1 Hektogram	=	3.5274 " "	1 deciliter
1 Kilogram	=	2.2046 pounds	1 liter
1 Myriagram	=	22.046 " "	1 dekaliter
1 Quintal	=	220.46 " "	1 hektoliter
1 Millier	=	2204.6 " "	1 cubic metre

Quantity of Water.

A Kilogram is commonly called a Kilo.

TABLE FOR FACILITATING APPROXIMATE CALCULATIONS FROM THE METRIC TO THE ENGLISH SYSTEM OF WEIGHTS AND MEASURES.

Feet.	Metres.	Feet.	Metres.	Pounds, Avoirdupois.	Kilograms.	Pounds, Avoirdupois.	Kilograms.
1	0.30	3.28	1	1	0.45	2.20	1
2	0.61	6.56	2	2	0.91	4.41	2
3	0.91	9.84	3	3	1.36	6.61	3
4	1.22	13.12	4	4	1.81	8.82	4
5	1.52	16.40	5	5	2.26	11.02	5
6	1.83	19.69	6	6	2.72	13.23	6
7	2.13	22.97	7	7	3.18	15.43	7
8	2.44	26.25	8	8	3.62	17.64	8
9	2.74	29.53	9	9	4.08	19.84	9

U. S. Gallons.	Imperial Gallons.	Litres.	Cubic Metres.	U. S. Gallons.	Imperial Gallons.	Litres.	Cubic Metres.
1	0.83	3.79	0.0038	1.20	1	4.54	0.0045
2	1.67	7.57	0.0076	2.40	2	9.08	0.0091
3	2.50	11.36	0.0114	3.60	3	13.63	0.0136
4	3.33	15.14	0.0151	4.80	4	18.17	0.0182
5	4.17	18.93	0.0189	6.00	5	22.71	0.0227
6	5.00	22.71	0.0227	7.20	6	27.26	0.0273
7	5.83	26.50	0.0265	8.40	7	31.80	0.0318
8	6.66	30.38	0.0303	9.60	8	36.34	0.0363
9	7.50	34.07	0.0341	10.80	9	40.89	0.0409

U. S. Gallons.	Imperial Gallons.	Litres.	Cubic Metres.	Miles.	Kilometres.	Miles.	Kilometres.
0.26	0.22	1	0.001	1	1.61	0.62	1
0.53	0.44	2	0.002	2	3.22	1.24	2
0.79	0.66	3	0.003	3	4.83	1.86	3
1.05	0.88	4	0.004	4	6.44	2.49	4
1.32	1.10	5	0.005	5	8.05	3.11	5
1.58	1.32	6	0.006	6	9.66	3.73	6
1.85	1.54	7	0.007	7	11.27	4.35	7
2.11	1.76	8	0.008	8	12.87	4.97	8
2.38	1.98	9	0.009	9	14.48	5.59	9

MENSURATION OF SURFACES.

Area of any parallelogram=base multiplied by perpendicular height.

Area of any triangle=base multiplied by $\frac{1}{2}$ perpendicular height.

Area of any circle=diameter squared, multiplied by .7854.

Area of sector of circle=arc multiplied by $\frac{1}{2}$ of radius.

Area of segment of circle=area of sector of equal radius, less area of triangle.

Area of parabola=base multiplied by $\frac{2}{3}$ of height.

Area of ellipse=longest diameter multiplied by shortest diameter, multiplied by .7854.

Area of cycloid=area of generating circle multiplied by 3.

Area of any regular polygon=sum of its sides multiplied by perpendicular from its center to one of its sides divided by 2.

Surface of cylinder=area of both ends plus length multiplied by circumference.

Surface of cone=Area of base plus circumference of base multiplied by $\frac{1}{2}$ slant height.

Surface of sphere=diameter squared, multiplied by 3.1416.

Surface of frustum=sum of girt at both ends multiplied by $\frac{1}{2}$ slant height plus area of both ends.

Surface of cylindrical ring=thickness of ring added to the inner diameter multiplied by the thickness, multiplied by 9.8698.

Surface of segment=height of segment multiplied by whole circumference of sphere of which it is a part.

PROPERTIES OF THE CIRCLE.

Circumference of a circle=diameter multiplied by 3.1416.

Circumference of a circle=radius multiplied by 6.2832.

Circumference of an oval= $\frac{1}{2}$ sum of two diameters multiplied by 3.1416.

Side of an equal square=diameter multiplied by .8862.

Side of an inscribed square=diameter multiplied by .7071.

Area of a circle=diameter squared, multiplied by .7854.

Diameter of a circle=circumference divided by 3.1416.

The circle contains a greater area than any plane figure bounded by an equal perimeter or outline.

The areas of circles are to each other as the squares of their diameters.

Any circle whose diameter is double that of another contains four times the area of the other.

Area of a circle is equal to the area of a triangle whose base equals the circumference, and perpendicular equals the radius.

MENSURATION OF SOLIDS.

Cylinder's contents=area of one end multiplied by length.

Sphere's contents=cube of diameter multiplied by .5236.

Segment of sphere=square root of height added to three times the square of radius of base multiplied by height and by .5236.

Cone or pyramid=area of base multiplied by $\frac{1}{3}$ perpendicular height.

Frustum of a cone=product of diameter of both ends plus sum of their squares multiplied by perpendicular height, multiplied by .2618.

Solidity of a wedge=area of base multiplied by $\frac{1}{2}$ perpendicular height.

Frustum of a wedge= $\frac{1}{2}$ perpendicular height multiplied by sum of the areas of the two ends

Solidity of a ring=thickness plus inner diameter multiplied by square of the thickness, multiplied by 2.4674.

HYDROSTATIC TABLES.

1 cubic inch of water weighs .03617 pounds.

1 cubic foot of water weighs 62.46 pounds.

1 gallon of water weighs $8\frac{1}{3}$ pounds.

1 gallon of water contains 231 cubic inches.

1 cubic foot of water contains $7\frac{1}{2}$ gallons.

1 cubic foot of water contains 1728 cubic inches.

Valuable Formulæ.—From the foregoing rules and equivalents may be deduced the following Concise Formulæ for computing the Capacity, Required Power, and Speed of Pumps:

Let

D=diameter of pump cylinder in inches.

S=length of stroke in inches.

N=number of strokes per minute.

Q=quantity of water raised per minute in gallons.

H=height in feet water is elevated from surface, or height of column of water.

Then

$D^2 \times .7854$ =the area of a circle (of cylinder) of a given diameter.

$D^2 \times S \times .7854$ =capacity of pump per stroke in cubic inches.

$\frac{D^2 \times S \times .7854}{231}$ =capacity of pump per stroke in gallons.

$\frac{D^2 \times S \times .7854}{1728}$ =capacity of pump per stroke in cubic feet.

$\frac{D^2 \times S \times .7854 \times 8.355}{231}$ =capacity of pump per stroke in pounds of water.

$D^2 \times S \times .7854 \times N$ =capacity of pump per minute in cubic inches.

$\frac{D^2 \times S \times .7854 \times N}{231}$ =capacity of pump per minute in gallons=(Q).

$\frac{D^2 \times S \times .7854 \times N}{1728}$ =capacity of pump per minute in cubic feet.

$\frac{QH \times 8.355}{33,000}$ =horse power required to elevate a given quantity of water per minute to a certain height.

$H \times .434$ =pounds pressure (per square inch) of a column of water.

A miner's inch of water is approximately equal to a supply of 12 gallons per minute.

The friction of water in pipes increases with the square of its velocity.

The capacity of pipes increases with the square of their diameter. Thus, doubling the diameter increases the capacity four times.

**APPROXIMATE NUMBER OF CUBIC FEET OF AIR
ONE SQUARE FOOT OF RADIATOR
WILL HEAT.**

One Square Foot of Radiator Surface Will Heat With	In Dwellings, School Rooms, Offices, Etc.	In Halls, Stores, Lofts, Factories, Etc.	In Churches, Large Auditoriums, Etc.
Direct steam radiation.....	60 to 80 Cubic Ft.	75 to 100 Cub. Ft.	150 to 200 Cub. Ft.
Indirect steam radiation.....	40 " 50 " "	50 " 70 " "	100 " 140 " "
High temperature direct hot water radiation.....	50 " 70 " "	65 " 90 " "	130 " 180 " "
Low temperature direct hot water radiation.....	30 " 50 " "	35 " 65 " "	70 " 150 " "
High temperature indirect hot water radiation...	30 " 60 " "	35 " 75 " "	70 " 150 " "
Low temperature indirect hot water radiation...	20 " 40 " "	25 " 50 " "	50 " 100 " "

The above proportions will give a temperature in the buildings described of 70 deg. Fahr., the thermometer being at zero in outside atmosphere.

While there is no iron rule for computing the proper amount of radiation for heating buildings, owing to the variable conditions that enter into the calculations, the above table will prove valuable if allowances are made for extreme cases.

It is well to remember that small rooms, rooms with large window surfaces or exposed sides, and rooms with exceptionally thick walls or fireproof tiling, require more radiating surface in proportion to space than is ordinarily needed. Frame buildings require more radiation than stone, and stone more than brick.

5

RAILROAD FREIGHT CLASSIFICATION.

For Less Than Carload Shipments.

Less than carload shipment to all points west of the Mississippi River including Mexico, are governed by the Western Classification.

Goods contained in this catalogue, in the kind of packages specified, take the different classes as shown below.

The following is based on Western Classification current October 1, 1904, and we will not be held responsible for any amendements or changes that may be made after that date.

Explanation of Classes—D 1, Double First Class; 1½, One and One-Half Times First Class; 1, First Class; 2, Second Class; 3, Third Class; 4, Fourth Class. Released means that goods are shipped at owner's risk.

Articles.	Class.	Articles.	Class.
Acid—Muritic, cooked.....bottles	D 1	Fittings—Sink, Brass or N. P.....boxed	2
“ raw..... “	D 1	Urinal, “ “ “ “ “ “	2
“ “carboys	D 1	Fixtures—Gas, Brass.....boxes or bbls.	1
Antimony.....boxes or barrels	2	Fountains—Drinking, Iron Enl'd...boxed	2
Asbestos—Mill Board.....	4	Heaters—Hot Water, for wood or coal...	3
Paper.....boxes or rolls	3	Water, “Domestic”.....	3
Babbitt Metal.....boxed	4	“ for Gas, Instantaneous, }	1½
Balls—Copper Floats.....boxes or barrels	2	with Copper or N. P. Jackets }	
Glass “ “ “ “	2	“ for Gas with Iron Jackets	2
Basins—Crockery...boxes, barrels or crates	2	Hoppers—Closet, Iron, boxes, crates or casks	2
		Slop, Iron, “ “ “ “	2
		ose—Rubber or Cotton...bales or boxes	1
		ydants, Fire.....	3
		lass Urinal Stalls.....boxes or crates	4
		terceptors—Grease, Iron.....	2
		on—Corrugated, Black and Galvanized	4
		Plished.....Metal cases with wood covers	4
		Sheet, Black and Galvanized.....	4
		Iron Ridge Cap.....in packages	1
		Lavatories—Crockery.....boxed	2
		Iron, Enl'd...boxed or crated	2
		Marble, Not Released, “ “ “ “	1
		Released “ “ “ “	4
		Ships', wooden, set up “ “ “	1½
		Lavatory Fittings—Brass or N. P.....boxed	2
		Lead—Bar.....sacks or boxes	4
		Caulking.....“ “ “ “	4
		Pig.....“ “ “ “	4
		Sheet.....rolls boxed	4
		“.....“ slatted	4
		Bends.....boxes or bbls.	3
		Ferrules.....“ “ “ “	3
		Soldering Nipples... “ “ “ “	3
		Traps.....“ “ “ “	3
		Washers.....boxed	3
		Machines—Pipe Threading and Cutting.....crated	1
		“ “ “ “ “ “...boxed	2
		“ Tapping.....“ “	2
		“.....crated	1
		Marble—For Shower Baths, Not Re- }	1
		leased.....boxed or crated }	
		For Shower Baths, Released }	4
	boxed or crated }	
		Floor Slabs Released...boxed or crated	4
		“ Not “ “ “ “ “ “	1
		Urinal Stalls, “ “ “ “ “ “	1
		“ “ Released “ “ “ “	4

ERRATA.

Articles.	Class.
Boilers—Range, Iron.....	3
Hot Water.....knocked down	3
Steam..... “ “	3
Boiler Stands..... “ “	3
knocked down, boxes or bbls.	4
Bowls—Closet, Crockery...boxes, bbls. }	2
or crates }	
Boxes—Street Washer.....	3
Valve.....	3
Ventilating.....	3
Brackets—Brass or Iron.....boxes or bbls.	2
Brass Goods—Hose Sprinklers..... boxed	2
Plumbers, Brass and N. P. “	2
Water..... “	2
Brass—Sheet or Roll..... “	2
Bronze Rods..... “	2
.....loose	1
Burners—Paint, Oil or Gasoline.....boxed	1½
Charcoal..... bbls. or sacks	3
Closet Combinations.....boxed or crated	1
Closets, Ships'..... “ “ “ “	1
Cocks—Basin, Bath, Pantry or Urinal.....boxed	2
Copper Sheets..... “	2
Fittings—Bathroom, Brass or N.P...boxed	2
“ Crockery..... “	2
“ Glass..... “	1
Bath Tub, Brass and N. P. “	2
Brass.....boxes, bbls. or kegs	2
Cast Iron Screwed.....	4
“ Soil Pipe.....	4
Closet, Brass or N. P.....boxed	2
Lavatory “ “ “ “	2
Malleable.....	4

Railroad Freight Classification—Continued.

Articles.	Class.	Articles.	Class.
Meters—Water.....boxed or crated	1	Tanks—Closet, Iron.....boxed or crated	2
Mirrors—Plate glass.....boxed	1	“ Wood..... “ “ “	2
Nails—Wire, Barbed.....boxes	3	Urinal, Iron..... “ “ “	2
“ “kegs	4	“ Wood..... “ “ “	2
Oakum.....bales	2	Tin—Bar.....	2
Packing—Rubber.....boxes or bdl.	1	Pig.....	2
Pipe—Block Tin.....boxes or crates	1	Tin Plate.....boxed	4
Cast Soil.....	4	Tools—Plumbers’.....	2
Conductor, Galv.....nested	2	Tinner’s..... “	2
“ “boxed or crated	1	Torches—Braziers..... “	1½
Lead..... “	3	Painters’..... “	1½
“drums, casks or boxes	4	Plumbers’, Oil and Gasoline “	1½
“on reels slatted	4	Traps—Brass or N. P.....	2
Sewer.....	3	Cast Iron Fittings.....bdls.	4
Wrought.....bdls. or pieces	4	“ “ Sewer.....	2
Pipes—Bath Supply, Brass or N. P.....boxed	2	Grease, Brass or N. P.....boxed	1
Closet Flush, “ “ “boxed }	2	“ Iron.....	3
or crated }	2	“ “ Enl’d.....boxed or crated	2
“ Supply, “ “ “boxed }	2	“ “ Stone.....	1
Lavatory, “ “ “boxed	2	Lead.....boxes or bbls.	3
Plumbing Goods not otherwise specified, including a miscellaneous assortment of plumbing appliances or materials.....boxed	2	Steam.....crates, “ “ “	4
Polish—Metal, Liquid..... “	2	“ Weighing 100 lbs. or over.....	4
“ Paste..... “	4	“ less than 100 lbs.....	1
Pots—Fire, Plumbers’ & Tinner’s Gasoline... “	1½	Trough—Eaves, Galv.nested, crated or boxed	2
“ “ “ “ Sheet Iron.. “	1½	Tube—Speaking, Tin..... “ “ “	1
Radiators—Steam or Water.....	3	Tubing—Brass or N. P.....boxes, bbls, or casks	2
Ranges—Closet, Iron.....boxed or crated	2	“ “ “ “loose	1
“ “nested	3	Tubs—Bath, Crockery.....boxed or crated	1
Urinal.....	3	“ Iron Enl’d..... “ “ “	1
“ “boxed or crated	2	“ Steel Cop. Ln’d.. “ “ “	1
Receptors—Shower Bath, Crockery.....boxed }	1	“ Zinc “ .. “ “ “	1
or crated }	1	“ “ “ “ “ “ “	1
“ “ Iron Enl’d.....boxed }	1	“ Zinc..... “ “ “	1
or crated }	1	Foot, Crockery..... “ “ “	1
Rivets—Copper or Tinned..boxes, kegs or bbls.	3	Iron Enl’d... “ “ “	1
Plain..... “ “ “	4	Laundry, Cement.....crated	3
Rosin.....barrels or boxes	4	“ Crockery...boxed or crated	3
Seats—Bath Tub.....boxed	2	“ Galv. “ “ “	3
Closet, Wood.....boxed or crated	3	“ Iron Enl’d... “ “ “	3
Sink Fittings, Brass or N. P.....boxed	2	Sitz, Crockery..... “ “ “	1
Sinks—Crockery.....crated or “	3	“ Iron Enl’d.... “ “ “	3
Iron Enameled..... “ “ “	2	Urinals—Crockery ..boxes, bbls. or crates	2
“ “ nested “ “ “	3	Enl’d, Iron “ “ “ “	2
Kitchen..... “ “ “ “	3	Public, Crock’y “ “ “ “	2
“ and Steel, Single “ “ “	2	“ Iron .. “ “ “ “	2
Pantry, Copper..... “	1	Valves—Brass.....	2
Slop, Iron Enameled.....crated or “	2	Bronze.....boxes, bbls., or kegs	2
Steel.....nested, “ “ “	3	Iron.....	4
Wash, Iron Enameled... “ “ “	2	Vises.....	2
“ “ “ “nested	3	Washers—Buggy.....	3
Slate Urinal Stalls.....boxed or crated	3	Waste—Cotton.....bdls.	3
Solder.....boxed	3	Wire—Copper or Brass...bdls, rolls, boxes, bbls, casks	2
Sprinklers—Hose.....	2	Iron or Std. Copp’d.. “ “ “ “ “	4
Lawn..... “	2	“ “ Galv.. “ “ “ “ “	4
		“ “ Plain.. “ “ “ “ “	4
		“ “ Tinned.. “ “ “ “ “	2
		Zinc—Sheet.....casks	4
		“rolled and not packed	1
		Slab.....	4

LIBRARY OF CONGRESS



0 022 055 021 7